



JBM[®]
TU HERRAMIENTA

ESTUCHES DE HERRAMIENTAS

5

MALETINES DE HERRAMIENTAS
MALETAS DE ALUMINIO
AUTOCLÉ
ESTUCHES DE VASOS
ESTUCHES DE PUNTAS
MALETINES DE PUNTAS
ADAPTADORES
ESTUCHES MINI CON CARRACA
SETS DE VASOS
SETS DE PUNTAS
HERRAMIENTAS AISLADAS



HERRAMIENTAS MANUALES

33

LLAVES
HERRAMIENTAS EN PULGADA
DESTORNILLADORES
MEDICIÓN
CANDADOS
MARTILLOS
SIERRAS
CINCELES
REMACHADORAS
CARRACAS
BARRAS DE EXTENSIÓN
HERRAMIENTAS DE INSPECCIÓN
CORTATUBOS
PELACABLES
ALICATES
LLAVES DE GANCHO /
ROMPETUERCAS / INGLESAS
LLAVES STILLSON / SARGENTOS



MOBILIARIO DE TALLER

65

CARROS DE HERRAMIENTAS
MÓDULOS DE HERRAMIENTAS
ACCESORIOS / RECAMBIOS
PARA CARROS
ARMARIOS
ACCESORIOS PARA MESAS
MESAS DE TRABAJO
CAJAS DE HERRAMIENTAS
TABURETES / CAMILLAS
YUNQUES / TORNILLOS DE
BANCO



HERRAMIENTAS ELÉCTRICAS A BATERÍA

87

LLAVES DE IMPACTO
CARRACA / ATORNILLADOR
TALADRO DE IMPACTO
PULIDORA
SIERRAS
MULTIHERRAMIENTA OSCILANTE
PISTOLAS
ASPIRADOR/COMPRESOR
ILUMINACIÓN LED
JARDINERÍA
ALMACENAMIENTO
BATERÍAS / CARGADORES
ACCESORIOS /
CONSUMIBLES



ILUMINACIÓN

113

PORTÁTILES DE TALLER
PORTÁTILES DE LUZ FRONTAL
LUPAS LED / LINTERNAS
FOCOS LED/ ALINEADORES DE FAROS/ TOMAS DE MECHERO Y
TRANSFORMADORES
BARRAS LED
LÁMPARA LED INDUSTRIAL
GIROFAROS
AVISADORES ACÚSTICOS
FAROS DE TRABAJO
PARA REMOLQUE
BOMBILLAS TURISMO



HERRAMIENTAS NEUMÁTICAS

131

PISTOLAS DE IMPACTO
PARA CAMIONES
TALADROS/CARRACAS
CORTADORAS / KIT PULIDORA
AMOLADORAS
DESTALONADOR DE LLANTAS
/ESMILADORAS DE VÁLVULAS
LIJADORAS ORBITAL / PULIDORAS
MARTILLOS NEUMÁTICOS
DISCOS DE CORTE / EXPOSITORES
PISTOLAS DE INFLADO / DPF
FILTROS DE AIRE / ACEITES LUBRICANTES
PISTOLAS VARIAS
CARRETES MANGUERA DE AIRE
MANGUERAS DE AIRE /
CONECTORES ADAPTADORES / ENGANCHES



ÚTILES, VASOS Y PUNTAS DE IMPACTO

149

SETS DE VASOS DE IMPACTO
BARRAS DE EXTENSIÓN
/ ARTICULACIONES DE IMPACTO
SETS DE PUNTAS
ADAPTADORES DE IMPACTO
/ VASOS DE IMPACTO DE 3/4" Y 1"
UTILAJE DE IMPACTO
VEHÍCULOS PESADOS



CARROCERÍA

159

PARA CHAPISTA
PARA FAROS
CASCOS SOLDADURA / SETS DE PALANCAS
JUEGO PARA ABRIR COCHES
/ SUSTITUCIÓN DE LUNAS
MORDAZAS
PISTOLAS DE SILICONA / VENTOSAS
CINTAS DE SUJECIÓN / CARRO Y ALMACENAJE
CABALLETES / SOPORTES
MANTENIMIENTO DEL VEHÍCULO
/EXPOSITORES
COLCHONETAS
PLATAFORMAS DE ALUMINIO



FRENOS

173

REPOSICIONADORES PARA
PISTONES DE FRENO
REPARACIÓN / MANTENIMIENTO /
SANGRADORES DE FRENO



UTILAJE

177

SISTEMA DE LUBRICACIÓN
SISTEMA DE INYECCIÓN
REPARADOR DE ROSCAS
MEDIDOR DE COMPRESIÓN
CALENTADORES
EXTRACTORES
DINAMOMÉTRICAS
MULTIPLICADORES DE FUERZA /
EMBRAGUE
SISTEMA AACCC
SISTEMA DE REFRIGERACIÓN
CULATA / VÁLVULAS
COMPRESORES DE MUELLES
VARIOS
ORGANIZADORES / BANDEJAS
CORTADORAS DE CADENA /
CEPILLOS



KITS DE CALADO (TIMING TOOLS)

217

BMW
MERCEDES
VAG
RENAULT / NISSAN
FORD / MAZDA
JAGUAR / LAND ROVER
OPEL / VAUXHALL
CITROËN / PEUGEOT / ALFA ROMEO
VARIOS
MÓDULOS Y CARROS CON
KITS DE CALADO
LLAVES Y EXTRACTORES



ACCESORIOS LUBRICANTES

247

GATOS DE CARRETILLA
GATOS BOTELLA
CABALLETES
PORTA RUEDAS
PRENSAS
GRÚAS
SOPORTES PARA MOTORES
PARA MOTOCICLETAS
TRANSPALET



HERRAMIENTAS HIDRÁULICAS

259

GATOS DE CARRETILLA
GATOS BOTELLA
CABALLETES
PORTA RUEDAS
PRENSAS
GRÚAS
SOPORTES PARA MOTORES
PARA MOTOCICLETAS
TRANSPALET



HERRAMIENTAS ELÉCTRICAS

271

ARRANQUE DE VEHÍCULOS
CARGADORES / COMPROBADORES
DE BATERÍA
MEDIDORES DE CORRIENTE
TERMÓMETROS
ENDOSCOPIOS
SOLDADORES
AMOLADORA DE MESA
LIMPIADORAS DE PIEZAS
ASPIRADORAS
CALEFACTORES / ROBOT CORTACÉSPED
HIDROLIMPIADORAS
CARRETES DE CABLE ELÉCTRICO
VENTILADORES



ENERGÍA RENOVABLE Y MOVILIDAD DEL FUTURO

285

ESTACIÓN DE ENERGÍA PORTÁTIL
PANELES SOLARES
COCHE ELÉCTRICO / CABLES
ACCESORIOS
HERRAMIENTAS AISLADAS



ACCESORIOS

291

CARRETES
ESCALERAS
CARROS
ORGANIZADORES
PARA COCHE
KITS DE EMERGENCIA / BOTIQUINES
SENSORES DE APARCAMIENTO
ALFOMBRILLAS
ESCOBILLAS LIMPIAPARABRISAS
CONTRAPESAS
VÁLVULAS TPMS
PARA NEUMÁTICOS
FUELLE PALIER TURISMO UNIVERSAL
/ HERRAMIENTA NEUMÁTICA PARA EL
MONTAJE DE FUELLES DE PALIER



SEGURIDAD Y EPIS

315

GUANTES / EPIS
BOTIQUINES
MASCARILLAS / DISPENSADORES
CÁMARAS TÉRMICAS /
TERMÓMETROS / DETERGENTES
DE SUPERFICIES / LIMPIADORES
DISTANCIA DE SEGURIDAD
DESINFECCIÓN DE ESPACIOS
/ MEDIDOR DE OZONO



CONSUMIBLES

323

PASACABLES / PASADORES
PASADORES / TORNILLOS
Y TUERCAS
REMACHES
ARANDELAS
OBUSES
JUNTAS TÓRICAS /
TUBOS TERMORETRACTILES
CONECTORES DE MANGUERA
/ ENGRASADORES
ABRAZADERAS / MUELLES
/ FUSIBLES
TERMINALES
CLIPS PLÁSTICOS



ROPA LABORAL

345

CHALECOS / CHAQUETAS



PROMOCIONALES

347

PRODUCTOS
PROMOCIONALES
EXPOSITORES
Y ACCESORIOS
PACKAGING





JBM es tu marca de herramientas profesionales
Empresa líder especializada en la industria y la automoción

+5.000 PRODUCTOS
DISPONIBLES

+20.000 EUROPALLETS
EN STOCK

+450 PRODUCTOS
NUEVOS AL AÑO

+55 EXPORTAMOS A
MÁS DE 55 PAÍSES

**SERVICIO
DE CALIDAD
AVALADO POR MÁS DE
11.000 CLIENTES**

▶ **MÁS DE 30 AÑOS DE EXPERIENCIA EN EL SECTOR**

En JBM somos especialistas en la distribución de herramientas y equipamiento de automoción, ofreciendo un servicio cercano y de calidad a nuestros más de 11.000 clientes repartidos en más de 55 países.

▶ **EXPERTOS EN DISTRIBUCIÓN Y LOGÍSTICA**

JBM cuenta con una red logística en constante mejora que permite una distribución rápida y eficaz no solo en la península ibérica sino también a todos los clientes internacionales.

▶ **AMPLIA GAMA DE PRODUCTOS**

Ofrecemos una gama completa de más de 4.000 artículos en cajas de herramientas, maletines de herramientas, todo tipo de herramientas manuales, armarios de herramientas, utillaje de taller, iluminación, estuches de consumibles...



**ENTREGA ENTRE 24-48H EN
PENÍNSULA IBÉRICA Y FRANCIA**



**SEDE EN ESPAÑA Y ALMACÉN DE
MÁS DE 6.000M²**





ESTUCHES DE HERRAMIENTAS

- 7 MALETINES DE HERRAMIENTAS
- 20 MALETAS DE ALUMINIO
- 23 AUTOCLÉ
- 24 ESTUCHES DE VASOS
- 25 ESTUCHES DE PUNTAS
- 27 MALETINES DE PUNTAS
- 28 ADAPTADORES
- 29 ESTUCHES MINI CON CARRACA
- 29 SETS DE VASOS
- 29 SETS DE PUNTAS
- 31 HERRAMIENTAS AISLADAS

ACABADOS DE ALTA CALIDAD



DIVISIBLE EN DOS
PARA UNA MEJOR
ORGANIZACIÓN



CIERRE METÁLICO
MEJORADO



MANGO
ACABADO EN
GOMA PARA UNA
MEJOR SUJECIÓN



MALETÍN DE HERRAMIENTAS DE 216 PIEZAS CON VASOS HEXAGONALES

54034 178,00€

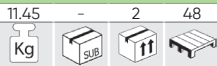

CINCADO

54045 179,00€

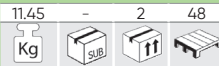

CROMADO

ACERO
S2

CrV

216
PCS

54034

DESPIECE
DISPONIBLE



54045

DESPIECE
DISPONIBLE



CONTIENE

	1/2" x14	13, 14, 15, 16, 17, 18, 19, 20, 21, 22, 24, 27, 30, 32mm
	3/8" x10	10, 11, 12, 13, 14, 15, 16, 17, 18, 19mm
	1/4" x13	4, 4.5, 5, 5.5, 6, 7, 8, 9, 10, 11, 12, 13, 14mm
	1/2" x5	16, 17, 18, 19, 22mm
	3/8" x6	10, 11, 12, 13, 14, 15mm
	1/4" x7	4, 5, 6, 7, 8, 9, 10mm
	1/2" x3	E20, E22, E24
	3/8" x6	E10, E11, E12, E14, E16, E18
	1/4" x5	E4, E5, E6, E7, E8
	T2 x3	1/2" - 3/8" - 1/4"
	1/2" x2	125, 250mm
	3/8" x1	125mm
	1/4" x2	50, 100mm
	x3	1/2" - 3/8" - 1/4"
	1/2" x1	adaptador 3/8" (H) - 1/2" (M)

	1/2" x1	8mm
	3/8" x1	8mm
	1/4" x1	6mm
	1/2" x2	16, 21mm
	3/8" x1	18mm
	1/2" x12	8, 9, 10, 11, 12, 13, 14, 15, 16, 17, 18, 19mm
	1/2" x7	1.27, 1.5, 2, 2.5, 3, 4, 5mm
	1/4" x1	
	1/4" x1	
	1/4" x1	
	1/2" x1	T70
	1/2" x1	14mm
	x3	PH0, PH1, PH2
	x3	PZ0, PZ1, PZ2
	x4	3, 4, 5, 6mm
	x4	SL4, SL5.5, SL6.5, SL7
	x8	T8, T9, T10, T15, T20, T25, T27, T30
	x8	T8, T9, T10, T15, T20, T25, T27, T30

	8mm x4	7, 8, 10, 12mm
	6mm x6	2, 2.5, 3, 4, 5, 6mm
	8mm x3	SL8, SL10, SL12
	8mm x3	PH2, PH3, PH4
	8mm x3	PZ2, PZ3, PZ4
	8mm x5	T40, T45, T50, T55, T60
	6mm x3	T5, T6, T7
	8mm x5	T40, T45, T50, T55, T60
	6mm x1	T7
	8mm x4	M10, M11, M12, M13
	6mm x5	M5, M6, M7, M8, M9
	8mm x2	M10, M12
	6mm x3	M5, M6, M8
	8mm x1	TS50
	6mm x8	TS10, TS15, TS20, TS25, TS27, TS30, TS40, TS45
	x4	0, 1, 2, 3mm
	x3	6, 8, 10mm
	6mm x4	4, 6, 8, 10mm
	x3	1, 2, 3mm
	x4	1, 2, 3, 4mm
	6mm x1	1/4"

MALETÍN DE HERRAMIENTAS DE 216 PIEZAS CON VASOS DE 12 CANTOS - CINCADO

54250 188,00€



ACERO S2

CrV

216 PCS



DESPIECE DISPONIBLE



CONTIENE

	1/2" x14	13, 14, 15, 16, 17, 18, 19, 20, 21, 22, 24, 27, 30, 32mm
	3/8" x10	10, 11, 12, 13, 14, 15, 16, 17, 18, 19mm
	1/4" x13	4, 4.5, 5, 5.5, 6, 7, 8, 9, 10, 11, 12, 13, 14mm
	1/2" x5	16, 17, 18, 19, 22mm
	3/8" x6	10, 11, 12, 13, 14, 15mm
	1/4" x7	4, 5, 6, 7, 8, 9, 10mm
	1/2" x3	E20, E22, E24
	3/8" x6	E10, E11, E12, E14, E16, E18
	1/4" x5	E4, E5, E6, E7, E8
	72 x3	1/2" - 3/8" - 1/4"
	1/2" x2	125, 250mm
	3/8" x1	125mm
	1/4" x2	50, 100mm
	x3	1/2" - 3/8" - 1/4"
	1/2" x1	adaptador 3/8" (H) - 1/2" (M)

	1/2" x1	8mm
	3/8" x1	8mm
	1/4" x1	6mm
	1/2" x2	16, 21mm
	3/8" x1	18mm
	1/2" x12	16, 17, 18, 19mm
	1/2" x7	1.27, 1.5, 2, 2.5, 3, 4, 5mm
	1/4" x1	
	1/4" x1	
	1/4" x1	
	1/2" x1	T70
	1/2" x1	14mm
	x3	PH0, PH1, PH2
	x3	PZ0, PZ1, PZ2
	x4	3, 4, 5, 6mm
	x4	SL4, SL5.5, SL6.5, SL7
	x8	T8, T9, T10, T15, T20, T25, T27, T30
	x8	T8, T9, T10, T15, T20, T25, T27, T30

	8mm x4	7, 8, 10, 12mm
	6mm x6	2, 2.5, 3, 4, 5, 6mm
	8mm x3	SL8, SL10, SL12
	8mm x3	PH2, PH3, PH4
	8mm x3	PZ2, PZ3, PZ4
	8mm x5	T40, T45, T50, T55, T60
	6mm x3	T5, T6, T7
	8mm x5	T40, T45, T50, T55, T60
	6mm x1	T7
	8mm x4	M10, M11, M12, M13
	6mm x5	M5, M6, M7, M8, M9
	8mm x2	M10, M12
	6mm x3	M5, M6, M8
	8mm x1	TS50
	6mm x8	TS10, TS15, TS20, TS25, TS27, TS30, TS40, TS45
	x4	0, 1, 2, 3mm
	x3	6, 8, 10mm
	6mm x4	4, 6, 8, 10mm
	x3	1, 2, 3mm
	x4	1, 2, 3, 4mm
	6mm x1	1/4"

MALETÍN DE HERRAMIENTAS DE 132 PIEZAS CON VASOS HEXAGONALES

54082 188,00€

CrV

132 PCS

11.00	-	2	56
Kg	sub	ff	

ESPECIAL AUTOMOCIÓN



DESPIECE DISPONIBLE

CONTIENE

	1/2"	x7	19,21, 22, 24, 27, 30, 32mm
	3/8"	x11	8, 9, 10, 11, 12, 13, 14, 15, 16, 17, 18, 19mm
	1/4"	x10	8, 9, 10, 11, 12, 13, 14, 15, 16, 17, 18, 19mm
	3/8"	x4	13, 14, 15, 17 mm
	1/4"	x4	8, 10, 12, 13mm
	3/8"	x6	E8, E10, E11, E14, E16, E20
	1/2"	x1	
	3/8"	x1	
	1/4"	x1	
	1/2"	x2	125, 250mm
	3/8"	x2	75, 150mm
	1/4"	x1	50mm
		x1	Ø14mm

		x1	3/8"(H)-1/2"(M)
		x1	3/8"(H)-1/2"(M)
		x1	3/8"(H)-1/4"(M)
	1/2"	x1	
	3/8"	x1	
	1/4"	x1	
	1/2"	x3	17, 19, 22mm
	1/4"	x1	6mm
		x1	
		x1	PH2x100
		x1	SL6x100
		x12	8, 9, 10, 11, 12, 13, 14, 15, 16, 17, 18, 19mm
		x1	

	1/2"	x1	H17
	1/2"	x1	21mm
	3/8"	x2	16, 18mm
	1/2"	x1	T52
	1/2"	x1	M16
		x2	5,5, 6,5mm
		x2	PH0, PH3
	3/8"	x2	PZ1, PZ3
		x4	4,5, 6,8mm
		x6	T20, T30, T40, T45, T50, T55
		x3	4,5, 6,5mm
		x3	PH1, PH2, PH3
	6mm	x3	PZ1, PZ2, PZ3
		x4	3,4, 5,6
		x7	T10, T15, T20, T25, T27, T30, T40
		x9	1,5, 2,2, 3, 4, 5, 6, 8, 10mm
		x1	
		x1	

MALETÍN DE HERRAMIENTAS DE 179 PIEZAS CON VASOS HEXAGONALES

54035 149,00€



CINCADO

54046 150,00€



CROMADO

ACERO
S2

CrV

179
PCS

54035



DESPIECE
DISPONIBLE

54046



DESPIECE
DISPONIBLE

ACERO
S2



CONTIENE

	1/2" x17	10, 11, 12, 13, 14, 15, 16, 17, 18, 19, 20, 21, 22, 24, 27, 30, 32mm
	3/8" x10	10, 11, 12, 13, 14, 15, 16, 17, 18, 19mm
	1/4" x13	4, 4.5, 5, 5.5, 6, 7, 8, 9, 10, 11, 12, 13, 14mm
	1/2" x5	16, 17, 18, 19, 22mm
	3/8" x6	10, 11, 12, 13, 14, 15mm
	1/4" x7	4, 5, 6, 7, 8, 9, 10mm
	1/2" x2	E20, E24
	3/8" x6	E10, E11, E12, E14, E16, E18
	1/4" x5	E4, E5, E6, E7, E8
	T2 x3	1/2" - 3/8" - 1/4"
	1/2" x1	125mm
	3/8" x1	125mm
	1/4" x2	50, 100mm
	1/2" x1	250mm

	x3	1/2" - 3/8" - 1/4"
	1/2" x2	16, 21mm
	3/8" x1	18mm
	1/2" x1	8mm
	3/8" x1	8mm
	1/4" x1	6mm
	x7	1,27, 1,5, 2, 2,5, 3, 4, 5mm
	x1	1/4"
	x1	1/4"
	x3	PH1, PH2, PH3
	x3	PZ1, PZ2, PZ3
	x5	2, 3, 4, 5, 6mm
	x3	SL4, SL5.5, SL7
	x8	T8, T9, T10, T15, T20, T25, T27, T30
	x8	T8, T9, T10, T15, T20, T25, T27, T30

	x11	T5, T6, T7, T8, T9, T10, T15, T20, T25, T27, T30
	x9	T7, T10, T15, T20, T25, T27, T30, T40, T45
	x5	M5, M6, M7, M8, M9
	x3	M5, M6, M8
	x2	PH3, PH4
	x2	PZ3, PZ4
	x8	7, 8, 10, 12, 14mm
	x3	SL8, SL10, SL12
	x6	T40, T45, T50, T55, T60, T70
	x6	T40, T45, T50, T55, T60, T70

MALETÍN DE HERRAMIENTAS DE 113 PIEZAS CON VASOS DE 12 CANTOS

54036 99,00€



CINCADO

54047 100,00€



CROMADO

ACERO
S2

CrV

113
PCS

54036



DESPIECE
DISPONIBLE

54047



DESPIECE
DISPONIBLE

ACERO
S2

CONTIENE

	1/2"	x17	10, 11, 12, 13, 14, 15, 16, 17, 18, 19, 20, 21, 22, 24, 27, 30, 32mm
	1/4"	x13	4, 4.5, 5, 5.5, 6, 7, 8, 9, 10, 11, 12, 13, 14mm
	1/2"	x5	14, 15, 17, 19, 22mm
	1/4"	x8	6, 7, 8, 9, 10, 11, 12, 13mm
	1/2"	x8	E10, E11, E12, E14, E16, E18, E20, E24
	1/4"	x5	E4, E5, E6, E7, E8
	T2	x2	1/2" - 1/4"
	1/2"	x2	125, 250mm
	1/4"	x2	50, 100mm

	x2	1/2" - 1/4"
	1/2"	x1 adaptador 3/8" (H) - 1/2" (M)
	1/2"	x1 8mm
	x5	7, 8, 10, 12, 14mm
	x3	SL8, SL10, SL12
	x2	PH3, PH4
	x2	PZ3, PZ4
	x5	T40, T45, T50, T55, T60
	x5	5, 6, 8, 10, 12mm

	1/2"	x2	16, 21mm
	x3	1.5, 2, 2.5mm	
	x1	1/4"	
	x1	1/4"	
	x2	PH1, PH2	
	x2	PZ1, PZ2	
	1/4"	x4	3, 4, 5, 6mm
	x3	SL4, SL5.5, SL6.5	
	x8	T8, T10, T15, T20, T25, T27, T30	

MALETÍN DE HERRAMIENTAS DE 108 PIEZAS CON VASOS HEXAGONALES

54037 88,00€



54048 89,00€



ACERO
S2

CrV

108
PCS

CINCADO

CROMADO



54048



DESPIECE
DISPONIBLE

54037



DESPIECE
DISPONIBLE

ACERO
S2



CONTIENE

	1/2" x17	10, 11, 12, 13, 14, 15, 16, 17, 18, 19, 20, 21, 22, 24, 27, 30, 32mm
	1/4" x13	4, 4.5, 5, 5.5, 6, 7, 8, 9, 10, 11, 12, 13, 14mm
	1/2" x5	14, 15, 17, 19, 22mm
	1/4" x8	6, 7, 8, 9, 10, 11, 12, 13mm
	1/2" x8	E10, E11, E12, E14, E16, E18, E20, E24
	1/4" x5	E4, E5, E6, E7, E8
	T2	x2 1/2" - 1/4"
	1/2"	x2 125, 250mm
	1/4"	x2 50, 100mm
		x2 1/2" - 1/4"
	1/2"	x1 adaptador 3/8" (H) - 1/2" (M)

	1/2"	x2 16, 21mm
	1/2"	x1 8mm
		x3 1.5, 2, 2.5mm
		x1 1/4"
		x1 1/4"
	+	x2 PH3, PH4
	*	x2 PZ3, PZ4
	8mm	x5 7, 8, 10, 12, 14mm
		x3 SL8, SL10, SL12
	*	x5 T40, T45, T50, T55, T60

	+	x2 PH1, PH2
	*	x2 PZ1, PZ2
	1/4"	x4 3, 4, 5, 6mm
		x3 SL4, SL5.5, SL6.5
	*	x8 T8, T10, T15, T20, T25, T27, T30

MALETÍN DE HERRAMIENTAS DE 94 PIEZAS CON VASOS HEXAGONALES

54038

88,00€

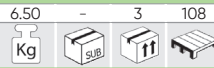

54049

88,00€

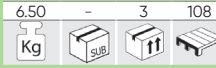

CrV

94
PCS

CINCADO

CROMADO

54049



DESPIECE
DISPONIBLE

54038



DESPIECE
DISPONIBLE



ACERO
S2

CONTIENE

	1/2" x18	10, 11, 12, 13, 14, 15, 16, 17, 18, 19, 20, 21, 22, 23, 24, 27, 30, 32mm
	1/4" x13	4, 4.5, 5, 5.5, 6, 7, 8, 9, 10, 11, 12, 13, 14mm
	1/2" x4	14, 15, 17, 19mm
	1/4" x8	6, 7, 8, 9, 10, 11, 12, 13mm
	72 x2	1/2" - 1/4"
	1/2" x2	125, 250mm
	1/4" x2	50, 100mm
	x2	1/2" - 1/4"
	1/2" x1	adaptador 3/8" (H) - 1/2" (M)

	1/2" x1	8mm
	x3	1.5, 2, 2.5mm
	1/2" x2	16, 21mm
	x2	PH3, PH4
	x2	PZ3, PZ4
	8mm x4	8, 10, 12, 14mm
	x3	SL8, SL10, SL12
	x4	T40, T45, T50, T55
	8mm x1	1/4"

	x1	1/4"
	x1	1/4"
	x1	1/4"
	x2	PH1, PH2
	x2	PZ1, PZ2
	1/4" x4	3, 4, 5, 6mm
	x3	SL4, SL5.5, SL7
	x6	T8, T10, T15, T20, T25, T30

MALETÍN DE HERRAMIENTAS 303 PIEZAS CON VASOS HEXAGONALES

53212 149,00€

945 - 2 48
Kg SUB 11

CROMADO



DESPIECE DISPONIBLE



CrV 303 PCS

1/2" 1/4"



CONTIENE

	1/2"	x18	10, 11, 12, 13, 14, 15, 16, 17, 18, 19, 20, 21, 22, 23, 24, 27, 30, 32mm
	1/4"	x13	4, 4.5, 5, 5.5, 6, 7, 8, 9, 10, 11, 12, 13, 14mm
	1/2"	x2	125, 250mm
	1/4"	x2	50, 100mm
	1/2"	x1	8mm
	1/4"	x1	6mm
	1/2"	x1	adaptador 3/8" (H) - 1/2" (M)
	1/2"	x2	16, 21mm
		x2	1/2" - 1/4"
		x1	1/4"
		x2	SL3.0 x 50mm, SL2.5 x 50mm
		x3	PH0x50mm, PH00x50mm, PH000x50mm
		x2	SL4.0x100mm, SL6.5x125mm
		x2	PH1x80mm, PH2x100mm

	6mm	x9	1.5, 2, 2.5, 3, 4, 5, 5.5, 6, 8mm
	6mm	x10	1/16, 5/64, 3/32, 7/64, 1/8, 9/64, 5/32, 3/16, 7/32, 1/4
	8mm	x4	H5.5, H6.5, H7, H8
	6mm	x6	5/64, 3/32, 7/64, 1/8, 9/64, 5/32
	6mm	x6	2, 2.5, 3, 4, 5, 6mm
	6mm	x9	SL3, SL4, SL4.5, SL5, SL5.5, SL6, SL6.5, SL7, SL8
	8mm	x4	SL5.5, SL6.5, SL7, SL8
	6mm	x10	PH0 (x2), PH1 (x2), PH2 (x4), PH3 (x2)
	8mm	x2	PH3, PH4
	6mm	x10	PZ0 (x2), PZ1 (x2), PZ2 (x4), PZ3 (x2)
	8mm	x2	PZ3, PZ4
	6mm	x10	T8, T10, T15, T20, T25, T27, T30, T35, T40, T45
	8mm	x8	T25, T27, T30, T35, T40 (x2), T45, T50
	6mm	x9	T8, T10, T15, T20, T25, T27, T30, T35, T40
	6mm	x3	5, 6, 8mm
	8mm	x4	5, 6, 8, 10mm

	6mm	x3	6, 8, 10
	6mm	x3	C1, C2, C3
	6mm	x4	1, 2, 3, 4
	6mm	x4	4, 6, 7, 10mm
	6mm	x4	S0, S1, S2, S3
	6mm	x7	1, 2, 2.5, 3, 4, 5mm
	6mm	x13	1.5, 2, 2.5, 3, 3.2, 3.5, 4, 4.5, 4.8, 5, 5.5, 6, 6.5mm
	6mm	x1	
	6mm	x1	
	6mm	x10	
	6mm	x1	8"
	6mm	x1	3m
	6mm	x6	SL1.5, SL2, SL2.5, SL3, SL3.5, SL4
	6mm	x4	PH000, PH00, PH0, PH1
	6mm	x2	PZ0, PZ1
	6mm	x8	T5, T6, T7, T8, T9, T10, T15, T20
	6mm	x1	
	6mm	x23	
	6mm	x22	
	6mm	x10	
	6mm	x10	

MALETÍN DE HERRAMIENTAS DE 82 PIEZAS CON VASOS HEXAGONALES

53647 96,00€

6.13 - 3 108
Kg SUB 11

CROMADO



DESPIECE DISPONIBLE



CrV 82 PCS

1/2" 1/4"



CONTIENE

	1/2"	x12	13, 14, 15, 16, 17, 18, 19, 22, 24, 27, 30, 32mm
	1/4"	x13	4, 4.5, 5, 5.5, 6, 7, 8, 9, 10, 11, 12, 13, 14mm
	1/2"	x2	125, 250mm
	1/4"	x2	50, 100mm
	1/2"	x2	1/2" - 1/4"
	1/2"	x1	adaptador 3/8" (H) - 1/2" (M)

	8mm	x2	16, 21mm
	8mm	x1	8mm
	8mm	x9	8, 10, 11, 12, 13, 14, 17, 19, 22mm
	8mm	x1	150mm
	8mm	x1	1/4"
	8mm	x1	1/4"

	8mm	x2	PH3, PH4
	8mm	x2	PZ3, PZ4
	8mm	x4	8, 10, 12, 14mm
	8mm	x3	SL8, SL10, SL12
	8mm	x4	T40, T45, T50, T55
	8mm	x1	1/4"
	8mm	x2	PH1, PH2
	8mm	x2	PZ1, PZ2
	8mm	x4	3, 4, 5, 6mm
	8mm	x3	SL4, SL5.5, SL7
	8mm	x6	T8, T10, T15, T20, T25, T30

MALETÍN DE HERRAMIENTAS DE 74 PIEZAS CON VASOS DE 12 CANTOS

53074 78,00€

5,09 - 3 108



CROMADO



DESPIECE DISPONIBLE

74
PCS
CrV
1/2"
1/4"

CONTIENE

	1/2"	x18	10, 11, 12, 13, 14, 15, 16, 17, 18, 19, 20, 21, 22, 23, 24, 27, 30, 32mm
	1/4"	x10	4, 5, 5.5, 6, 7, 8, 10, 11, 12, 13mm
	72	x2	1/2" - 1/4"
	1/2"	x2	125, 250mm
	1/4"	x1	100mm
		x1	1/2"

	1/2"	x1	adaptador 3/8" (H) - 1/2" (M)
	1/2"	x1	21mm
		x3	1.5, 2, 2.5mm
		x1	1/4"
	1/4"	x1	6mm

	6mm	x5	PH0, PH1, PH2, PH3, PH4
		x5	PZ0, PZ1, PZ2, PZ3, PZ4
		x6	3, 4, 5, 6, 8, 10mm
		x5	SL3, SL4, SL5.5, SL6, SL7
		x8	T8, T10, T15, T20, T25, T27, T30, T40
		x4	4, 5, 6, 7mm

ESTUCHE DE HERRAMIENTAS 3/8" DE 59 PIEZAS CON VASOS DE 12 CANTOS

54168 49,00€

2,60 - 10 180



DESPIECE DISPONIBLE



59
PCS
CrV
3/8"

CONTIENE

	3/8"	x17	6, 7, 8, 9, 10, 11, 12, 13, 14, 15, 16, 17, 18, 19, 20, 21, 22mm
	72	x1	3/8"
	3/8"	x2	75, 150mm
	3/8"	x1	8mm
	3/8"	x1	8mm

	x1	3/8"	
	x2	PH3, PH4	
	x2	PZ3, PZ4	
	8mm	x5	7, 8, 10, 12, 14mm
		x3	8, 10, 12mm
	x5	T40, T45, T50, T55, T60	

	x1	1/4"	
	1/4"	x2	PH1, PH2
		x2	PZ1, PZ2
		x4	3, 4, 5, 6mm
		x3	4, 5.5, 6.5mm
		x7	T8, T10, T15, T20, T25, T27, T30

ESTUCHE DE HERRAMIENTAS CON 56 PIEZAS

54105 33,00€

1,25 - 10 300



DESPIECE DISPONIBLE



CrV 56
PCS

CONTIENE

	1/4"	x13	4, 4.5, 5, 5.5, 6, 7, 8, 9, 10, 11, 12, 13, 14mm
	72	x1	1/4"
	1/4"	x2	50, 100mm
		x1	1/4"
		x1	1/4"

	6mm	x4	SL4, SL5, SL6, SL7
		x3	M5, M6, M8
		x8	T8, T10, T15, T20, T25, T27, T30, T40
		x8	T8, T10, T15, T20, T25, T27, T30, T40
		x1	1/4"
	1/4"	x1	6mm
	6mm	x3	PH0, PH1, PH2
		x3	PZ0, PZ1, PZ2
		x6	3, 4, 5, 6, 7, 8mm
	6mm	x1	1/4"

ESTUCHE DE PUNTAS Y VASOS 130 PIEZAS CON CARRACA

53953 29,00€

1.50	-	10	420
Kg	SUB	11	12

CINCADO

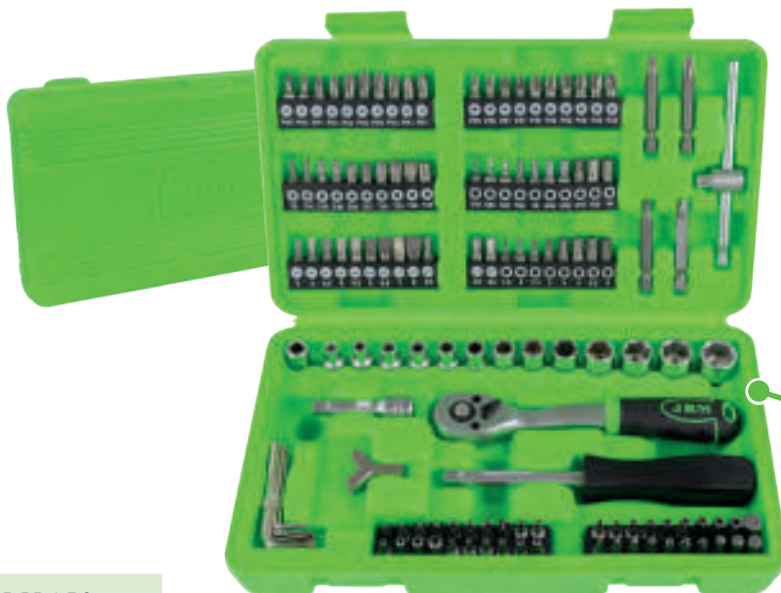

CrV 1/4" 130 PCS



DESPIECE DISPONIBLE



EN EXPOSITOR DE 10 UNIDADES

CONTIENE

	1/4" x13	4, 4.5, 5, 5.5, 6, 7, 8, 9, 10, 11, 12, 13, 14mm
	x1	1/4"
	1/4" x1	50mm
	x1	1/4"
	1/4" x1	6mm
	x1	1/4"
	x1	1/4"
	1/4" x7	1.27, 1.5, 2, 2.5, 3, 4, 5mm

	25mm x10	1/16, 5/64, 3/32, 7/64, 1/8, 9/64, 5/32, 3/16, 7/32, 1/4
	x9	1.5, 2, 2.5, 3, 4, 5, 5.5, 6, 8mm
	25mm x6	5/64, 3/32, 7/64, 1/8, 9/64, 5/32
	x6	2, 2.5, 3, 4, 5, 6mm
	25mm x9	3, 4, 4.5, 5, 5.5, 6, 6.5, 7, 8mm
	50mm x2	4, 6mm
	25mm x10	PH0(x2), PH1(x2), PH2(x4), PH3(x2)
	50mm x2	PH1, PH2
	25mm x10	PZ0(x2), PZ1(x2), PZ2(x4), PZ3(x2)

	25mm x10	T8, T10, T15, T20, T25, T27, T30, T35, T40, T45
	25mm x9	T8, T10, T15, T20, T25, T27, T30, T35, T40
	25mm x3	M5, M6, M8
	25mm x3	6, 8, 10mm
	25mm x3	C1, C2, C3
	25mm x4	1, 2, 3, 4mm
	25mm x4	4, 6, 8, 10mm
	25mm x4	0, 1, 2, 3mm

ESTUCHE DE HERRAMIENTAS 3/8" DE 59 PIEZAS CON VASOS HEXAGONALES

51819 48,00€

2.55	-	10	180
Kg	SUB	11	12

CINCADO

53219 49,00€

2.60	-	10	180
Kg	SUB	11	12

CROMADO

CrV 3/8" 59 PCS

51819



DESPIECE DISPONIBLE



53219



DESPIECE DISPONIBLE

CONTIENE

	3/8" x17	6, 7, 8, 9, 10, 11, 12, 13, 14, 15, 16, 17, 18, 19, 20, 21, 22mm
	x1	3/8"
	3/8" x2	75, 150mm
	3/8" x1	8mm
	3/8" x1	8mm

	x1	3/8"
	x2	PH3, PH4
	x2	PZ3, PZ4
	8mm x5	7, 8, 10, 12, 14mm
	x3	SL8, SL10, SL12
	x5	T40, T45, T50, T55, T60

	x1	1/4"
	x2	PH1, PH2
	x2	PZ1, PZ2
	1/4" x4	3, 4, 5, 6mm
	x3	SL4, SL5.5, SL6.5
	x7	T8, T10, T15, T20, T25, T27, T30

MALETÍN DE HERRAMIENTAS DE 22 PIEZAS

54116

66,00€

3,95	-	4	96
Kg	SUB	11	11



CrV

1/2"

22
PCS



DESPIECE DISPONIBLE



12 CANTOS

CONTIENE

		1/2"	x17	10, 11, 12, 13, 14, 15, 16, 17, 18, 19, 21, 22, 24, 27, 30, 32mm
		1/2"	x1	1/2"
		1/2"	x2	125, 250mm
		1/2"	x1	
		1/2"	x1	3/8"(H), 1/2"(M)

ESTUCHE DE 46 PIEZAS CON VASOS HEXAGONALES

54109

34,00€

1,40	-	10	360
Kg	SUB	11	11



CrV

1/4"

46
PCS



DESPIECE DISPONIBLE



CONTIENE

		1/4"	x13	4, 4.5, 5, 5.5, 6, 7, 8, 9, 10, 11, 12, 13, 14mm
		1/4"	x1	
		1/4"	x1	1/4"
		1/4"	x1	1/4"
		2"/4"	x2	
			x4	1,27, 1,5, 2,0, 2,5mm
			x1	
			x1	1/4"

ESTUCHE DE HERRAMIENTAS DE 56 PIEZAS

53102

36,00€

1,28	-	10	270
Kg	SUB	11	11



1/4"

CrV

56
PCS



DESPIECE DISPONIBLE



CONTIENE

		1/4"	x13	4, 4.5, 5, 5.5, 6, 7, 8, 9, 10, 11, 12, 13, 14mm
		1/4"	x1	1/4"
		1/4"	x2	50, 100mm
			x1	1/4"
			x1	1/4"

CROMADO

		1/4"	x1	
		1/4"	x1	6mm
			x3	PH0, PH1, PH2
		6mm	x3	PZ0, PZ1, PZ2
			x6	3, 4, 5, 6, 7, 8mm
		6mm	x1	1/4"

54140

36,00€

1,28	-	10	300
Kg	SUB	11	11



1/4"

CrV

56
PCS



DESPIECE DISPONIBLE

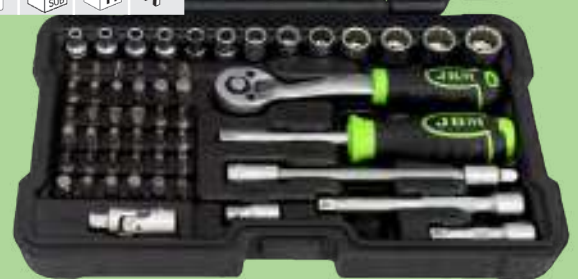

			x4	SL4, SL5, SL6, SL7
		6mm	x3	M5, M6, M8
			x8	T8, T10, T15, T20, T25, T27, T30, T40
			x8	T8, T10, T15, T20, T25, T27, T30, T40

IVA no incluido

MALETÍN DE HERRAMIENTAS 37 PIEZAS EN PULGADA

54106 89,00€

4.70 - 3 108
Kg SUB ff



CONTIENE

	1/2" x17	5/16", 3/8", 7/16", 1/2", 9/16", 19/32", 5/8", 11/16", 3/4", 13/16", 7/8", 15/16", 1", 1-1/16", 1-1/8", 1-3/16", 1-1/4", 3/16", 7/32", 1/4", 9/32", 5/16", 11/32", 3/8", 7/16"
	1/4" x8	
	53076 x2	1/2" - 1/4"
	1/2" x2	5", 10"
	1/4" x1	3"
	x1	1/2"
	x1	1/4"
	x2	1/2" - 1/4"
	x1	1/4"

37 PCS

1/4"

1/2"

CrV



MALETÍN DE HERRAMIENTAS 22 PIEZAS VASOS HEXAGONALES DE 1/2"

54108 66,00€

3.95 - 4 128
Kg SUB ff



CONTIENE

	1/2" x16	10, 11, 12, 13, 14, 15, 16, 17, 18, 19, 21, 22, 24, 27, 30, 32mm
	1/2" x1	
	1/2" x2	75, 125mm
	x1	3/8"(H)-1/2"(M)

22 PCS

1/2"

CrV



MALETÍN DE HERRAMIENTAS DE 61 PIEZAS VASOS SPLINE DE 12 CANTOS DE 1/2" Y 1/4"

52722 87,00€

4.63 - 4 60
Kg SUB ff

CINCADO



DESPIECE DISPONIBLE



53108 92,00€

4.83 - 3 90
Kg SUB ff

CROMADO



- Útil para:



DESPIECE DISPONIBLE

CONTIENE

	1/2" x11	14, 15, 16, 17, 18, 19, 22, 24, 27, 30, 32mm
	1/4" x12	4, 4.5, 5, 5.5, 6, 7, 8, 9, 10, 11, 12, 13mm
	53076 x2	1/2" - 1/4"
	1/2" x2	125, 250mm
	1/4" x2	50, 100mm
	x2	1/2" - 1/4"
	1/2" x1	adaptador 3/8" (H) - 1/2" (M)
	1/2" x2	16, 21mm
	1/4" x1	6mm
	x3	1.5, 2, 2.5mm
	x1	1/4"
	x1	1/4"

	x3	PH1, PH2, PH3
	x3	PZ1, PZ2, PZ3
	6mm x5	3, 4, 5, 6, 8mm
	x3	SL4, SL5.5, SL7
	x5	T10, T15, T20, T25, T30
	6mm x1	1/4"

MALETÍN DE HERRAMIENTAS DE 77 PIEZAS

54258 58,00€

7.50 - 4 -
Kg SUB ff



CONTIENE

	x5	PH0, PH1, PH2, PH2, PH3
	x5	PZ0, PZ1, PZ2, PZ2, PZ3
	x5	3, 4, 5, 5.5, 6mm
	x5	T10, T15, T20, T25, T30
	X4	6x7mm, 8x9mm, 10x11mm, 12x13mm
	X9	1.5, 2, 2.5, 3, 4, 5, 6, 8, 10mm
	X10	
	X10	

	X1	
	X1	
	X1	
	X1	
	X1	
	X1	
	X1	
	X3	PH2X100, PH00X50, PH000X50, SL6X100
	X3	SL2.5X50, SL3.0X50



CrV

77 PCS

MALETÍN DE HERRAMIENTAS DE 72 PIEZAS CON VASOS HEXAGONALES

51818

95,00€

7,15	-	3	60
Kg	SUB	11	

CINCADO

53106

99,00€

7,20	-	3	60
Kg	SUB	11	

CROMADO



CrV

72
PCS

1/2"

1/4"



53106



DESPIECE
DISPONIBLE

51818



DESPIECE
DISPONIBLE

CONTIENE

	1/2"	x13	10, 11, 12, 13, 14, 15, 17, 19, 22, 24, 27, 30, 32mm		x10	4, 5, 6, 7, 8, 9, 10, 11, 12, 13mm		x5	5, 6, 7, 8, 9mm		x2	1/2" - 1/4"		x2	16, 21mm		x1	6mm		x1	300gr																					
	ref. 53106	72	x2	1/2", 1/4"		ref. 51818	24	x2	1/2", 1/4"		x1	125mm		x1	75mm		x8	10, 11, 12, 13, 14, 15, 17, 19mm		x3	1,5, 2, 2,5mm		x1	1/4"		x1	PH6x40mm, PH6x100mm		x2	PH6x40mm, SL6x100mm, SL8x200mm		x3	SL6x40mm, SL6x100mm, SL8x200mm		x4	SL3, SL4, SL5, SL6		x3	PH1, PH2, PH3		x7	T10, T15, T20, T25, T27, T30, T40

MALETÍN DE HERRAMIENTAS 41 PIEZAS CON VASOS HEXAGONALES

52713

89,00€

6,30	-	4	96
Kg	SUB	11	

CINCADO



CrV

41
PCS

1/2"



DESPIECE
DISPONIBLE

CONTIENE

	1/2"	x11	10, 12, 13, 14, 15, 17, 19, 22, 24, 27, 30mm		x1	6"
	1/2"	x2	16, 21mm		x1	20x200mm
	24	x1	1/2"		x1	6-24V, 110mm
	1/2"	x1	125mm		x1	8"
	1/2"	x1			x2	8x10, 12x13mm
	1/2"	x1	adaptador 3/8" (H) - 1/2" (M)		x1	8x10mm
	1/2"	x8	7, 8, 10, 12, 13, 14, 17, 19mm		x1	75x300mm
	x4	6, 8, 10, 12mm		x1	300gr	
	+	x1	PH2x100mm		x1	6x150mm
	-	x1	SL6x100mm			

MALETA DE HERRAMIENTAS DE ALUMINIO

MALETA DE HERRAMIENTAS DE ALUMINIO 159 PIEZAS

53159 289,00€

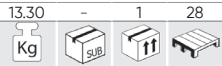

CrV

1/2"

1/4"

159
PCS

CINCADO



DESPIECE
DISPONIBLE



CONTIENE



	1/2"	x14	14, 15, 16, 17, 18, 19, 20, 21, 22, 23, 24, 27, 30, 32mm
	1/4"	x10	4, 5, 6, 7, 8, 9, 10, 11, 12, 13mm
	12	x2	1/4" - 1/2"
	1/2"	x2	50, 100mm
	1/4"	x2	125, 250mm
	1/4"	x1	150mm
		x2	1/4" - 1/2"
	1/2"	x1	adaptador 3/8" (H) - 1/2" (M)
		x2	1/4" - 1/2"
	1/4"	x1	250mm
	1/4"	x1	110mm
	1/2"	x2	16, 21mm
		x1	1/4"

	x9	8, 10, 11, 12, 13, 15, 17, 19, 22mm	
	x9	1.5, 2, 2.5, 3, 4, 5, 6, 8, 10mm	
	x1	100-250V	
	x1		
	+	x2	PH1x80, PH2x10mm
	-	x4	SL3x75, SL4x100, SL6.5x125, SL8x150mm
	+	x1	PH00x50mm
	-	x1	SL2.5x50mm
	x1	250mm	
	x1	160mm	
	x1	180mm	
	x1	160mm	
	x1	200mm	
	x1	7" (180mm)	
	x1	220mm	
	x1	160mm	

	x1	
	x6	1,5mm
	x1	
	x1	300gr
	x1	3m
	x1	200mm
	x5	
	x1	18mm
	x10	
	x40	6.35mm
	x15	8mm

MALETA DE HERRAMIENTAS DE ALUMINIO

MALETA DE HERRAMIENTAS DE 135 PIEZAS CON VASOS HEXAGONALES

53928 278,00€

13,50	-	1	32
Kg	Sub	11	11

1/2" 1/4" 135 PCS

CrV 











DESPIECE DISPONIBLE















CONTIENE









	x1	250mm
	x1	180mm
	x1	180mm
	x1	200mm
	x1	160mm
	x1	200mm
	x1	
	x3	
	x1	18mm



















	1/2"	x10	10, 11, 12, 13, 14, 15, 17, 19, 22, 24mm
	1/4"	x9	4, 5, 6, 7, 8, 9, 10, 11, 12mm
	7/2	x2	1/2" - 1/4"
	1/2"	x2	125, 250mm
	1/4"	x2	50, 100mm
		x2	1/2" - 1/4"
	1/2"	x1	adaptador 3/8" (H) - 1/2" (M)
		x1	1/4"
	1/4"	x1	6mm
	1/2"	x2	16, 21mm
		x9	8, 10, 11, 12, 13, 14, 17, 19, 22mm
		x1	150mm



	x1	
	x1	
	x1	100-250v
	x1	
	x1	300gr.
	x1	
	x1	5m



	x1	
	x3	SL1.5, SL2, SL3
	x4	PH000, PH00, PH0, PH1
	x8	T4, T5, T6, T7, T8, T10, T15, T20
	x4	TS0.8, TS1.2, TS1.5, TS2.0
	x1	H2.0
	x9	1.5, 2, 2.5, 3, 4, 5, 6, 8, 10mm
	x2	PH1x80mm, PH2x100mm
	x4	SL3.0x75mm, SL4.0x100mm, SL6.5x125mm, 8x150mm
	x5	

	x1	
	x1	6.35mm
	x4	PH1, PH2, PH2, PH3
	x4	PZ1, PZ2, PZ2, PZ3
	x4	SL3, SL4, SL5, SL6
	x4	H3, H4, H5, H6
	x6	T10, T15, T20, T25, T27, T30, T40
	x7	TT10, TT15, TT20, TT25, TT27, TT30, TT40

IVA no incluido

MALETA DE HERRAMIENTAS DE ALUMINIO

MALETA DE HERRAMIENTAS DE 108 PIEZAS

53444 195,00€

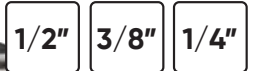
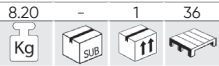

CINCADO

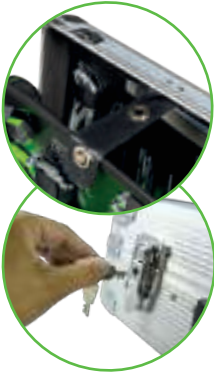

CONTIENE



	1/4"	x8	4, 4.5, 5, 5.5, 6, 7, 8, 9mm
	3/8"	x9	10, 11, 12, 13, 14, 15, 17, 18, 19mm
	1/2"	x1	
	72	x1	1/2"
	3/8"	x2	75, 150mm
	1/2"	x2	75, 150mm
	1/4"	x1	adaptador 3/8" (H) - 1/4" (M)
	1/4"	x1	25mmL
	1/4"	x1	1/4"

	3/8"	x1	16mm
	x8	6x7, 8x9, 10x11, 12x13, 14x15, 16x17, 18x19, 20x22mm	
	x9	1.5, 2, 2.5, 3, 4, 5, 6, 8, 10mm	
	+	x2	PH1x80, PH2x100mm
	-	x4	SL3.5x75, SL4x100, SL6.5x125, SL8x150mm
	+	x1	PH00x50mm
	-	x1	SL2.5x50mm

	x1	100-250V		x1	
	x1	250mm		x6	1,5mm
	x1	180mm		x1	300gr
	x1	160mm		x31	
	x1	160mm		x1	
	x1	220mm		x1	7"
	x1	18mm		x1	3m
	x10				

ESTUCHE METÁLICO CON 22 PIEZAS DE AUTOCLÉ DE 1"

51616 378,00€

34.60	-	1	24
Kg	SUB	11	11



51855 378,00€

33.70	-	1	24
Kg	SUB	11	11



CrV 1" 22 PCS

CINCADO



CAJA METÁLICA

CONTIENE

	1"	x17	36, 38, 41, 46, 50, 54, 55, 58, 60, 63, 65, 67, 70, 71, 75, 77, 80mm
	1"	x1	650mm
	1"	x2	205, 410mm
	x1	1"	x1 1"

51616



DESPIECE DISPONIBLE

51855



DESPIECE DISPONIBLE

MALETÍN DE HERRAMIENTAS DE AUTOCLÉ DE 3/4"

53727 198,00€

14.65	-	1	40
Kg	SUB	11	11



CrV 3/4" 21 PCS

CINCADO

53728 198,00€

14.30	-	1	40
Kg	SUB	11	11



CONTIENE

	3/4"	x16	19, 21, 22, 23, 24, 26, 27, 29, 30, 32, 35, 36, 38, 41, 46, 50mm
	3/4"	x1	495mm
	3/4"	x3	100, 200, 400mm
	3/4"	x1	445mm



53728



DESPIECE DISPONIBLE

53727



DESPIECE DISPONIBLE

MALETÍN DE HERRAMIENTAS DE 39 PIEZAS CON VASO PASANTE

52418 164,00€

3.61	-	5	100
Kg	SUB	11	11



CrV 39 PCS

CROMADO

CONTIENE

	13mm	x12	4, 4.5, 5, 5.5, 6, 7, 8, 9, 10, 11, 12, 13mm
	19mm	x10	10, 11, 12, 13, 14, 15, 16, 17, 18, 19mm
	22mm	x5	20, 21, 22, 23, 24mm
	22mm - 1/2"	x3	27, 30, 32mm
		x3	13, 19, 22mm
	1/4"	x1	13mm
	3/8"	x1	19mm
	1/2"	x1	22mm
		x3	13, 19, 22mm



ESTUCHE DE HERRAMIENTAS DE 14 PIEZAS GO-THROUGH

54090 56,00€

14 PCS

2.00	-	10	240
Kg	SUB	11	11



CONTIENE

	x11	13, 14, 15, 16, 17, 18, 19, 21, 22, 24, 27mm
	x1	75mmL, 12,5mm
	x1	1/2"
	x1	go-through

ESTUCHE 17 PIEZAS CON VASOS PASANTES

50623 60,00€



CrV

1/4"

17 PCS

CROMADO

0.63	-	10	320
Kg	SUB	11	11



CONTIENE

	x13	4, 4.5, 5, 5.5, 6, 7, 8, 9, 10, 11, 12, 13, 14mm
	x1	75mm
	x1	1/4"
	x1	145mm



ESTUCHE DE 6 VASOS 1/2" TORX TIPO E EXTRA LARGOS

53915 65,00€

CrV

1/2"

6 PCS

2.10	-	10	240
Kg	SUB	11	11

CINCADO

CONTIENE

	1/2"	x6	E10, E12, E14, E16, E18, E20
--	------	----	------------------------------

E12 Llave de vaso para culata de BMW:
- Motor M42, 1.8L, 4 cilindros, 16V, modelo 318 is desde 1989
- Motor M50, 2.0L, 2.5L, 6 cilindros, 24V, modelo 520i, 525i desde 1991

CABEZAL DE LOS VASOS EN ACABADO EN NEGRO



ESTUCHE DE 28 VASOS TORX CORTOS Y LARGOS

51930 39,00€

CrV

1/2"

3/8"

1/4"

28 PCS

2.12	-	10	240
Kg	SUB	11	11

CONTIENE

	1/4"	x5	25mm	E4, E5, E6, E7, E8
	3/8"	x5	28mm	E10, E11, E12, E14, E16
	1/2"	x4	38mm	E18, E20, E22, E24
	1/4"	x5	50mm	E4, E5, E6, E7, E8
	3/8"	x5	63mm	E10, E11, E12, E14, E16
	1/2"	x4	76mm	E18, E20, E22, E24

51930



DESPIECE DISPONIBLE

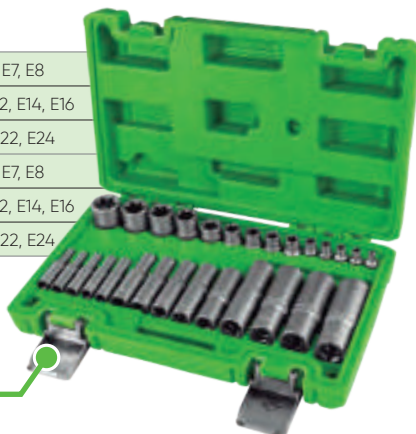

CINCADO

54141 42,00€

CrV

1/2"

3/8"

1/4"

28 PCS

2.15	-	10	240
Kg	SUB	11	11



DESPIECE DISPONIBLE

	1/4"	x5	25mm	E4, E5, E6, E7, E8
	3/8"	x5	28mm	E10, E11, E12, E14, E16
	1/2"	x4	38mm	E18, E20, E22, E24
	1/4"	x5	50mm	E4, E5, E6, E7, E8
	3/8"	x5	63mm	E10, E11, E12, E14, E16
	1/2"	x4	76mm	E18, E20, E22, E24



ESTUCHE 12 PUNTAS 1/2" PUNTA TORX

51261 36,00€

1.62 - 10 360



CINCADO



DESPIECE DISPONIBLE



1/2"	x6	T20, T25, T30, T40, T45, T50
	x1	T55
	x5	T60, T70, T80, T90, T100



DESPIECE DISPONIBLE

54154 37,50€

1.85 - 10 320



CrV 1/2" 12 PCS

55 mm 70 mm

CINCADO



CONTIENE



1/2"	x6	T20, T25, T30, T40, T45, T50
	x6	T55, T60, T70, T80, T90, T100

ESTUCHE 12 PUNTAS 1/2" PUNTA 12 CANTOS

51384 34,00€

1.62 - 10 360



CINCADO



53104 34,00€

1.75 5 10 240



CROMADO



CONTIENE



1/2"	x6	M4, M5, M6, M7, M8, M9
	x1	M10
	x5	M12, M14, M16, M18, M20

54164 34,00€

1.75 - 10 320



CrV 1/2" 12 PCS

CONTIENE



1/2"	x6	M4, M5, M6, M7, M8, M9
	x6	M10, M12, M14, M16, M18, M20

ESTUCHE 12 PIEZAS 1/2" PUNTA HEXAGONAL

51260 37,00€

1.92 - 10 360



CINCADO

51260



DESPIECE DISPONIBLE



CrV 1/2" 12 PCS



53105 37,00€

2.05 - 10 240



CROMADO

CONTIENE

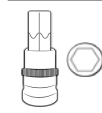

1/2"	x6	H5, H6, H7, H8, H10, H12
	x1	H14
	x5	H16, H17, H18, H19, H22

SET DE 6 PIEZAS 1/2" PUNTA TORX INVIOLEABLE

51410 36,00€

0.38 5 20 500



T55, T60, T70, T80, T90, T100

1/2" CrV 6 PCS



SET DE 6 PIEZAS 1/2" PUNTA 12 CANTOS INVIOLEABLE / PUNTA XZN

51409 36,00€

0.35 5 20 -



M10, M12, M14, M16, M18, M20

1/2" CrV 6 PCS



IVA no incluido

JBM / www.jbmcamp.com

25

MALETÍN PUNTAS 1/2" EXTRALARGOS 12 CANTOS Y RIBE

52603 74,00€



26
PCS

4.07	-	4	128
Kg	sub	ff	



52606 88,00€



32
PCS

CrV 1/2"

5.05	-	4	128
Kg	sub	ff	



CONTIENE

1/2"	x8 55mmL	M5, M6, M8, M9, M10, M12, M14, M16
	x7 100mmL	M5, M6, M8, M9, M10, M12, M14
	x7 140mmL	M5, M6, M8, M9, M10, M12, M14
	x4 200mmL	M8, M10, M12, M14



DESPIECE DISPONIBLE

CONTIENE

1/2"	x9 55mmL	M5, M6, M7, M8, M9, M10, M12, M13, M14
	x9 100mmL	M5, M6, M7, M8, M9, M10, M12, M13, M14
	x7 140mmL	M7, M8, M9, M10, M12, M13, M14
	x7 200mmL	M7, M8, M9, M10, M12, M13, M14



DESPIECE DISPONIBLE

MALETÍN DE PUNTAS HEXAGONALES Y TORX

52604 78,00€



30
PCS

4.62	-	4	144
Kg	sub	ff	



52605 76,00€



32
PCS

CrV 1/2"

4.60	-	4	144
Kg	sub	ff	



CONTIENE

1/2"	x9 55mmL	5, 6, 7, 8, 10, 12, 14, 17, 19mm
	x8 100mmL	5, 6, 7, 8, 10, 11, 12, 13mm
	x7 140mmL	5, 6, 7, 8, 10, 12, 14mm
	x6 200mmL	5, 6, 7, 8, 10, 12mm



DESPIECE DISPONIBLE

CONTIENE

1/2"	x10 55mmL	T20, T25, T27, T30, T40, T45, T50, T55, T60, T70
	x10 100mmL	T20, T25, T27, T30, T40, T45, T50, T55, T60, T70
	x6 140mmL	T40, T45, T50, T55, T60, T70
	x6 200mmL	T40, T45, T50, T55, T60, T70



DESPIECE DISPONIBLE

MALETÍN PUNTAS 55 PIEZAS HEAVY DUTY

52753 107,00€

2,96 - 4 184



S-2 3/8" 1/2" 55 PCS

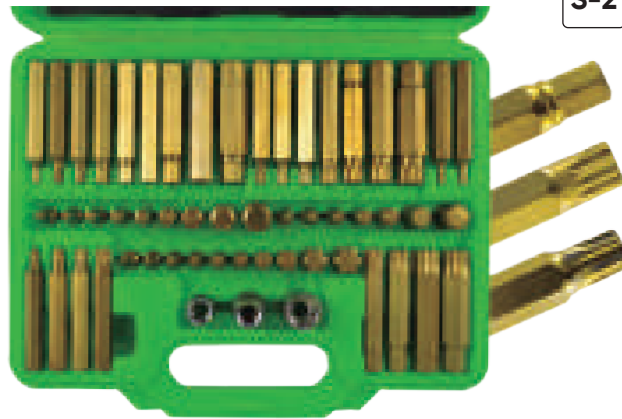

CONTIENE

	3/8"	x1	10mm
	1/2"	x2	10, 14mm
	30mm	x9	4, 5, 6, 7, 8, 10, 12, 14, 16mm - ISO 2136
	75mm	x9	4, 5, 6, 7, 8, 10, 12, 14, 16mm - ISO 2136
	30mm	x10	T20, T25, T30, T40, T45, T50, T55, T60, T70, T80 - DIN 2325
	75mm	x10	T20, T25, T30, T40, T45, T50, T55, T60, T70, T80 - DIN 2325
	30mm	x7	M5, M6, M8, M10, M12, M14, M16 - DIN 2325
	75mm	x7	M5, M6, M8, M10, M12, M14, M16 - DIN 2325

MALETÍN DE PUNTAS 42 PIEZAS PARA TORNILLOS DE 12 Y 6 CANTOS Y TORX

50983 48,00€

1,77 - 5 275



CONTIENE

	3/8"	x1	10mm
	1/2"	x1	10mm
	30mm	x7	4, 5, 6, 7, 8, 10, 12mm
	75mm	x7	4, 5, 6, 7, 8, 10, 12mm
	30mm	x8	T20, T25, T30, T40, T45, T50, T55, T60
	75mm	x8	T20, T25, T30, T40, T45, T50, T55, T60
	30mm	x5	M5, M6, M8, M10, M12
	75mm	x5	M5, M6, M8, M10, M12



50985 59,00€

1,74 - 5 275



INVIOABLE



CONTIENE

	3/8"	x1	10mm
	1/2"	x1	10mm
	30mm	x7	4, 5, 6, 7, 8, 10, 12mm
	75mm	x7	4, 5, 6, 7, 8, 10, 12mm
	30mm	x8	T20, T25, T30, T40, T45, T50, T55, T60
	75mm	x8	T20, T25, T30, T40, T45, T50, T55, T60
	30mm	x5	M5, M6, M8, M10, M12
	75mm	x5	M5, M6, M8, M10, M12



MALETÍN DE PUNTAS 75 PIEZAS RIBE, 12 CANTOS, TORX, TORX INV., HEXAGONAL

52550 92,00€

3,61 - 4 96



S-2 3/8" 1/2" 75 PCS



CONTIENE

	3/8"	x1	10mm
	1/2"	x2	10mm
	30mm	x7	4, 5, 6, 7, 8, 10, 12mm
	75mm	x7	4, 5, 6, 7, 8, 10, 12mm
	30mm	x8	T20, T25, T30, T40, T45, T50, T55, T60
	75mm	x8	T20, T25, T30, T40, T45, T50, T55, T60
	30mm	x5	M5, M6, M8, M10, M12
	75mm	x5	M5, M6, M8, M10, M12
	30mm	x8	M5, M6, M7, M8, M9, M10, M12, M14
	75mm	x5	M5, M6, M8, M10, M12
	30mm	x8	T20, T25, T30, T40, T45, T50, T55, T60
	75mm	x8	T20, T25, T30, T40, T45, T50, T55, T60

MALETÍN DE PUNTAS 208 PIEZAS

53574 47,00€

2,29	-	6	216
Kg	Sub	11	11

CrV 208 PCS



CONTIENE

25mmL x12	1,5, 2, 2,5, 3, 3,5, 4, 4,5, 5, 5,5, 6, 7, 8mm	25mmL x4	4, 6, 8, 10mm
50mmL x10	1/16, 5/64, 3/32, 7/64, 1/8, 9/64, 5/32, 3/16, 7/32, 1/4	50mmL x4	4, 6, 8, 10mm
75mmL x5	2,5, 3, 4, 5, 6mm	25mmL x4	1, 2, 3, 4mm
50mmL x5	2,5, 3, 4, 5, 6mm	50mmL x4	1, 2, 3, 4mm
25mmL x18	PH00, PH0, PH1(x5), PH2(x5), PH3(x5), PH4	25mmL x6	2, 2,5, 3, 4, 5, 6mm
50mmL x3	PH1, PH2, PH3	25mmL x6	5/64, 3/32, 7/64, 1/8, 9/64, 5/32
75mmL x3	PH1, PH2, PH3	25mmL x13	T5, 6, 7, 8, 9, 10, 15, 20, 25, 27, 30, 40, 45
25mmL x17	PZ00, PZ0, PZ1(x5), PZ2(x5), PZ3(x4), PZ4	25mmL x3	1, 2, 3mm
50mmL x3	PZ1, PZ2, PZ3	25mmL x4	0, 1, 2, 3mm
75mmL x3	PZ1, PZ2, PZ3	25mmL x3	M5, M6, M8
25mmL x14	T5, T6, T7, T8, T9, T10, T15, T20, T25, T27, T30, T35, T40, T45	25mmL x9	TS10, TS15, TS20, TS25, TS27, TS30, TS40, TS45, TS50
50mmL x7	T10, T15, T20, T25, T27, T30, T40	25mmL x12	SL2, SL2.5, SL3, SL3.5, SL4, SL4.5, SL5, SL5.5, SL6, SL6.5, SL7, SL8
75mmL x7	T10, T15, T20, T25, T27, T30, T40		
25mmL x3	6, 8, 10mm		
50mmL x3	6, 8, 10mm		

mm	x10	4, 5, 6, 7, 8, 9, 10, 11, 12, 13
"	x10	5/32, 3/16, 7/32, 1/4, 9/32, 5/16, 11/32, 3/8, 7/16, 1/2
6mm	x1	1/4" Adaptador
	x1	

ESTUCHE DE PUNTAS EN SURTIDO

52539 59,00€

1,90	-	5	128
Kg	Sub	11	11

ALLEN 8 CrV 85 PCS

CONTIENE

8mm	x2	PH3, PH4
	x2	PZ3, PZ4
	x5	7, 8, 10, 12, 14mm
	x3	SL8, SL10, SL12
	x5	T40, T45, T50, T55, T60



ESTUCHE DE PUNTAS 1/4" EN SURTIDO

52538 62,00€

2,07	-	16	128
Kg	Sub	11	11

CrV 1/4" 90 PCS

CONTIENE

1/4"	x2	PH1, PH2
	x2	PZ1, PZ2
	x5	3, 4, 5, 6mm
	x3	SL4, SL5.5, SL6.5
	x5	T8, T10, T15, T20, T25, T27, T30



ESTUCHE DE 6 ADAPTADORES

51333 18,00€

0,52	5	40	960
Kg	Sub	11	11

CrV 6 PCS

CINCADO

M	H
1/2"	3/4"
3/8"	1/2"
1/4"	3/8"
3/8"	1/4"
1/2"	3/8"
3/4"	1/2"



DESPIECE DISPONIBLE

REF.	DESCRIPCIÓN	Kg	€
11360	1/4H A 3/8M	0,02	2,60€
11361	1/4M - 3/8H	0,05	3,20€
11362	1/2H A 3/4M	0,13	5,20€
11363	3/8H A 1/2M	0,05	3,90€
11364	1/2H A 3/8M	0,05	4,50€
11365	3/4H A 1/2M	0,14	9,40€



ESTUCHE 6 ADAPTADORES DE IMPACTO

53743 39,70€

0,80	5	20	960
Kg	Sub	11	11

CrMo 6 PCS

M →
F →



DESPIECE DISPONIBLE

REF.	mm	Kg	Sub	11	€
14749	1/4" F - 3/8" M	-	20	100	2,00€
14750	3/8" F - 1/4" M	-	20	100	2,00€
14751	3/8" F - 1/2" M	-	20	100	4,00€
14752	1/2" F - 3/8" M	-	10	100	4,00€

M	H
3/4"	1/2"
1/2"	3/4"
3/8"	1/4"
1/4"	3/8"
1/2"	3/8"
3/8"	1/2"

ESTUCHE DE 38 PIEZAS CON CARRACA MINI DE 1/4"

53156 26,20€

0.48 6 36 1008

Kg SUB 11 12

52198 37,70€

0.45 6 36 1800

Kg SUB 11 12

CrV 1/4" 38 PCS



CONTIENE

		1/4"	x11	4, 4.5, 5, 6, 7, 8, 9, 10, 11, 12, 13mm
		72	x1	1/4"
			x2	PH3, PH4
			x2	PZ3, PZ4
			x5	4, 5, 6, 7, 8mm
		6mm	x3	SL6, SL8, SL10
			x2	T8, T9, T10, T15, T20, T25, T30, T40
			x4	M5, M6, M9, M10
			x1	1/4"

SET DE VASOS DE 1/2"

52714 15,70€

0.65 4 24 576

Kg SUB 11 12



52716 15,90€

0.61 4 24 576

Kg SUB 11 12



10, 11, 12, 13, 14, 15, 16, 17, 18, 19mm

1/2" 10 PCS

CrV



PRESENTADAS EN GUÍA METÁLICA



DESPIECE DISPONIBLE



PRESENTADAS EN GUÍA METÁLICA



DESPIECE DISPONIBLE

SET DE VASOS DE 1/4"

52715 10,00€

0.35 6 36 1152

Kg SUB 11 12



52717 11,00€

0.27 6 36 1152

Kg SUB 11 12



4, 4.5, 5, 5.5, 6, 7, 8, 9, 10, 11, 12, 13, 14mm

1/4" 13 PCS

CrV



PRESENTADAS EN GUÍA METÁLICA



DESPIECE DISPONIBLE



PRESENTADAS EN GUÍA METÁLICA



DESPIECE DISPONIBLE

SET DE PUNTAS 1/4", 18 PCS

52909 12,50€

0.35 8 32 1500

Kg SUB 11 12

S-2 1/4" 18 PCS

CrV

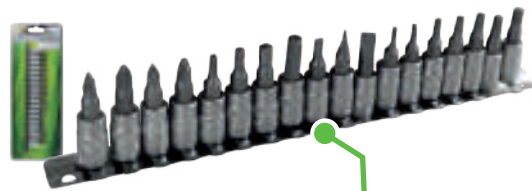

PRESENTADAS EN GUÍA METÁLICA



DESPIECE DISPONIBLE

SET DE PUNTAS 1/4", 30 PCS

52908 17,00€

0.60 8 32 500

Kg SUB 11 12

S-2 1/4" 30 PCS

CrV



PRESENTADAS EN GUÍA METÁLICA



DESPIECE DISPONIBLE

CONTIENE

	x2	PH1, PH2
	1/4" x2	PZ1, PZ2
	x4	3, 4, 5, 6mm
	1/4" x3	SL4, SL5.5, SL6.5
	1/4" x7	T8, T10, T15, T20, T25, T27, T30

CONTIENE

	x3	PH0, PH1, PH2
	1/4" x3	PZ0, PZ1, PZ2
	x4	3, 4, 5, 6mm
	x4	SL4, SL5.5, SL6.5, SL7
	1/4" x8	T8, T9, T10, T15, T20, T25, T27, T30
	1/4" x8	T8, T9, T10, T15, T20, T25, T27, T30

SET DE 7 PUNTAS TORX DE 3/8" Y 1/2"

53084 24,00€

0.60	5	20	880
Kg	SUB	ff	



1/2"

3/8"

7 PCS

3/8": T30, T40, T45, T50
1/2": T55, T60, T70

CrV



DESPIECE DISPONIBLE



PRESENTADAS EN GUÍA METÁLICA

SET DE 7 PUNTAS TORX INV. INVIOLEABLE 1/4"

53127 12,00€

0.15	5	100	1800
Kg	SUB	ff	



CrV

1/4"

7 PCS

T10, T15, T20, T25, T30, T40, T45



DESPIECE DISPONIBLE



PRESENTADAS EN GUÍA METÁLICA

SET DE PUNTAS TS 5 CARAS INVIOLEABLE

51746 12,00€

0.20	5	75	1050
Kg	SUB	ff	

PRESENTADAS EN GUÍA METÁLICA



TS10, TS15, TS20, TS25, TS30, TS40, TS45



CrV

1/4"

7 PCS

SET DE PUNTAS

50980 22,00€

0.76	5	20	300
Kg	SUB	ff	



1/2" 100mm: M12, M13, M14
3/8" 90mm: M6, M7, M8, M10

50982 22,00€

0.46	6	36	1080
Kg	SUB	ff	



3/8" 100mm HB3: 4, 5, 6, 7, 8, 10mm

52320 22,00€

0.76	5	20	480
Kg	SUB	ff	



1/2" 100mm: M12, M13, M14
3/8" 90mm: M6, M7, M8, M10



PRESENTADAS EN GUÍA METÁLICA

7 PCS

CrV

VASOS PUNTA XZN ESP. VAG

12029 5,50€

0.17	5	100	1500
Kg	SUB	ff	

INVIOLEABLE M16X58MM



12030 6,50€

0.25	8	80	-
Kg	SUB	ff	

INVIOLEABLE M16X100MM



CrV

1/2"

PUNTA EXTRALARGA DE 12 CANTOS 800MM DE 1/2"

REF.	DESCRIPCIÓN	Kg	SUB	ff	€
52059	Ø 8mm - 800mm	0,58	-	25	29,00€
52060	Ø 10mm - 800mm	0,58	-	25	32,00€
53667	Ø 12mm - 800mm	0,80	10	20	32,00€
53668	Ø 14mm - 800mm	1,05	10	20	34,00€

800mm



CrV

1/2"



HERRAMIENTAS AISLADAS

MALETÍN DE HERRAMIENTAS AISLADAS

54091 441,00€

4,20	-	3	72

	x2	4x100mm, 5,5x125mm
	x2	PH1x80mm PH2x100mm

	x1	185mm
	x1	
	x1	185mm
	x6	7x86mm, 8x99mm, 10x109mm, 12x127mm, 14x141mm, 17x156

CONTIENE

	3/8"	x10	8, 10, 11, 12, 13, 14, 16, 17, 18, 19, 21, 22mm
	3/8"	x1	200mm
	1/2"	x1	125mm
	3/8"	x1	200mm



CrV **3/8"** **26**
PCS

MÓDULO EVA DE HERRAMIENTAS AISLADAS VDE 26 PIEZAS

54093 441,00€

3,25	-	4	80

	x2	4x100mmL, 5,5x125mmL
	x2	PH1x80mm PH2x100mm

	x1	185mm
	x1	
	x1	185mm
	x6	7x86mm, 8x99mm, 10x109mm, 12x127mm, 14x141mm, 17x156

CONTIENE

	3/8"	x10	8, 10, 11, 12, 13, 14, 16, 17, 18, 19, 21, 22mm
	3/8"	x1	200mm
	1/2"	x1	125mm
	3/8"	x1	200mm



CrV **3/8"** **26**
PCS

MALETÍN DE HERRAMIENTAS AISLADAS

53154 462,00€

3,30	-	3	72

CONTIENE

	3/8"	x12	8, 10, 11, 12, 13, 14, 16, 17, 18, 19, 21, 22mm
	1/2"	x1	200mm
	1/2"	x2	125, 250mm
	3/8"	x1	200mm
	3/8"	x4	4, 5, 6, 8mm



CrV **3/8"** **20**
PCS

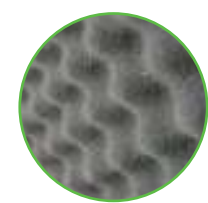

DESTORNILLADOR CON PUNTAS HASTA 1.000V

52009 36,00€

Optimizado para aplicaciones en trabajo con electricidad. Herramienta de seguridad.

0,34	10	50	1200
Kg	Sub	Paq	Paq



CONTIENE

	x2	PH1x100, PH2x100
	x4	SL0.4x2.5x100, SL0.8x4.0x100, SL1.0x5.5x100, SL1.2x6.5x100mm



Cumple con: DIN EN60900:2005-01 - EN60900:2004

ESTUCHE CON 50 DESTORNILLADORES AISLADOS

52521 125,00€

1,43	-	6	216
Kg	Sub	Paq	Paq

CrV 50 PCS



CONTIENE

	x3	PH0, PH1, PH2		x1	89
	x7	SL0.4x2.0, SL0.4x2.5, SL0.5x3.0, SL0.6x3.5, SL0.8x4.0, SL1.0x5.5, SL1.2x6.5mm		x1	Voltage Tester: 3.0 x 70 + Torx 31 x 105
	x3	PZ0, PZ1, PZ2		x5	H2.5, H3, H4, H5, H6
	x9	T6, T8, T9, T10, T15, T20, T25, T27, T30		x2	R1, R2
				x4	1, 2, 3, 4
				x4	4, 6, 8, 10
				x2	6.3 x 89, 8.1 x 89

SET DE DESTORNILLADORES AISLADOS 1.000V

52519 25,50€

0,14	5	10	840
Kg	Sub	Paq	Paq

CONTIENE

	x2	PH00x50, PH0x50mm
	x5	SL1.5x0.23x50, SL1.8x0.30x50, SL2.0x0.40x50, SL2.5x0.40x50, SL3.0x0.50x50mm



CrV 7 PCS



DESTORNILLADORES CON MÓDULO EVA CARBONO

15162 30,20€

0,65	-	10	240
Kg	Sub	Paq	Paq

DESPIECE DISPONIBLE

REF.	Ø	Kg	Sub	Paq	€
15227	0.5x3.0x75mm	0,02	10	50	3,50€
15228	0.8x4.0x100mm	0,05	10	50	4,00€
15229	1.0x5.5x125mm	0,08	5	50	5,00€
15230	1.2x6.5x150mm	0,11	5	50	5,00€
15231	PH0x75mm	0,02	10	50	3,50€
15232	PH1x80mm	0,05	10	50	4,00€
15233	PH2x100mm	0,08	5	50	5,00€
15234	Comprobador de corriente 140mm	0,02	10	50	3,00€

	x4	0.5x3.0x75, 0.8x4.0x100, 1.0x5.5x125, 1.2x6.5x150mm
	x3	PH0x75, PH1x80, PH2x100mm

8 PCS

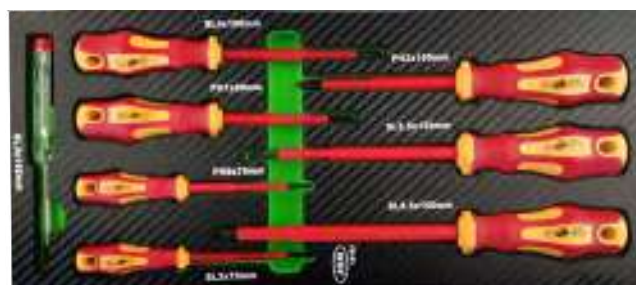

CUCHILLO AISLADO

RECTO

53164 16,50€

0,10	6	36	1152
Kg	Sub	Paq	Paq



CURVADO

53165 19,60€

0,10	6	36	1152
Kg	Sub	Paq	Paq



180mm
50mm

CrV





HERRAMIENTAS MANUALES

- 34 LLAVES
- 41 HERRAMIENTAS EN PULGADA
- 42 DESTORNILLADORES
- 44 MEDICIÓN
- 45 CANDADOS
- 46 MARTILLOS
- 47 SIERRAS
- 48 CINCELES
- 49 REMACHADORAS
- 50 CARRACAS
- 54 BARRAS DE EXTENSIÓN
- 55 HERRAMIENTAS DE INSPECCIÓN
- 57 CORTATUBOS
- 57 PELACABLES
- 57 ALICATES
- 63 LLAVES DE GANCHO
/ ROMPETUERCAS
/ INGLESAS
- 64 LLAVES STILLSON
/ SARGENTOS

SET DE LLAVES CON TRINQUETE

54101

61,00€

8x9, 10x11, 12x13, 14x15, 16x18, 17x19mm



6 PCS

0,90	-	10	750
Kg	SUB	11	11



DESPIECE DISPONIBLE

REF.	mm	Kg	SUB	€	REF.	mm	Kg	SUB	€
15632	8x9	0,15	10	9,35€	15635	14x15	0,22	10	11,00€
15633	10x11	0,16	10	9,50€	15636	16x18	0,26	5	12,30€
15634	12x13	0,19	10	10,60€	15637	17x19	0,28	10	12,50€



54117

74,00€

8,9,10,11,12,13,14,15,16,17,18, 19mm



12 PCS

1,80	5	10	240
Kg	SUB	11	11



DESPIECE DISPONIBLE

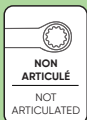

51318

98,00€

8, 9, 10, 11, 12, 13, 14, 15, 16, 17, 18, 19mm



12 PCS

2,15	5	10	240
Kg	SUB	11	11



DESPIECE DISPONIBLE



53017

57,00€

8, 10, 11, 13, 14, 17, 19mm



7 PCS

1,30	5	10	330
Kg	SUB	11	11



CROMADO



REF.	mm	Kg	SUB	€
10552	8mm	0,06	10	7,10€
10553	9mm	0,07	10	7,35€
10554	10mm	0,09	10	7,50€

REF.	mm	Kg	SUB	€
10555	11mm	0,09	10	7,80€
10556	12mm	0,11	10	8,10€
10557	13mm	0,13	10	8,10€

REF.	mm	Kg	SUB	€
10558	14mm	0,15	10	9,35€
10559	15mm	0,16	10	9,50€
10560	16mm	0,19	10	10,60€

REF.	mm	Kg	SUB	€
10561	17mm	0,22	10	11,00€
10562	18mm	0,26	5	12,30€
10563	19mm	0,28	10	12,50€

SET 7 LLAVES CON TRINQUETE EXTRALARGAS

54066

83,00€

2,00	5	175
Kg	SUB	11

MÓDULO ACABADO EN FIBRA DE CARBONO



CROMADO



7 PCS

DESPIECE DISPONIBLE



REF.	mm	Kg	SUB	€
13453	8mm	0,1	6	9,00€
13454	10mm	0,15	6	9,50€
13455	12mm	0,21	6	10,50€
13456	13mm	0,20	6	11,50€
13457	14mm	0,25	6	12,00€
13460	17mm	0,4	6	15,00€
13462	19mm	0,5	6	17,00€

8mm (23,5mmL)
10mm (29,3mmL)
12mm (32,8mmL)
13mm (34,9mmL)
14mm (36,7mmL)
17mm (41mmL)
19mm (42mmL)

MALETÍN CON 22 LLAVES COMBINADAS CON TRINQUETE

54041 198,00€

900	-	2	42
Kg	Sub	11	11

6, 7, 8, 9, 10, 11, 12, 13, 14, 15, 16, 17, 18, 19, 20, 21, 22, 23, 24, 27, 30, 32mm

90°



22 PCS

DESPIECE DISPONIBLE



REF.54041, 54117, 15122, 53871
DESPIECE DISPONIBLE

MÓDULO EVA CARBONO DE 12 LLAVES COMBINADAS CON TRINQUETE

REF.	mm	Kg	Sub	11	€	REF.	mm	Kg	Sub	11	€
13463	6mm	0,03	10		5,30€	13474	17mm	0,19	10		8,70€
13464	7mm	0,04	10		5,30€	13475	18mm	0,22	10		9,10€
13465	8mm	0,05	10		5,55€	13476	19mm	0,22	10		9,60€
13466	9mm	0,06	10		5,55€	13477	20mm	0,23	6		9,85€
13467	10mm	0,1	10		6,00€	13478	21mm	0,37	6		12,20€
13468	11mm	0,08	10		6,25€	13479	22mm	0,37	6		13,10€
13469	12mm	0,09	10		6,25€	13480	23mm	0,37	6		15,50€
13470	13mm	0,1	10		6,60€	13481	24mm	0,53	6		15,80€
13471	14mm	0,11	10		6,90€	13482	27mm	0,6	6		22,10€
13472	15mm	0,13	10		7,25€	13483	30mm	0,8	6		25,50€
13473	16mm	0,15	10		8,10€	13484	32mm	1,12	6		27,20€

15122 74,00€

1,70	-	10	200
Kg	Sub	11	11

8, 9, 10, 11, 12, 13, 14, 15, 16, 17, 18, 19mm

72°



12 PCS

CROMADO

DESPIECE DISPONIBLE

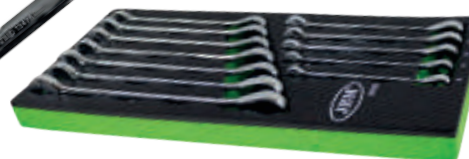

SET DE 12 LLAVES COMBINADAS CON TRINQUETE

53871 60,00€

1,60	2	6	288
Kg	Sub	11	11

DESPIECE DISPONIBLE



8, 9, 10, 11, 12, 13, 14, 15, 16, 17, 18, 19mm

72°



12 PCS

CROMADO



MÓDULO EVA CON 12 LLAVES MINI COMBINADAS ARTICULADAS CON TRINQUETE

54032 84,00€

1,45	-	10	240
Kg	Sub	11	11

8, 9, 10, 11, 12, 13, 14, 15, 16, 17, 18, 19mm

90°



12 PCS



REF.	mm	Kg	Sub	11	€	REF.	mm	Kg	Sub	11	€
15328	8mm	0,05	12		6,00€	15334	14mm	0,11	12		7,00€
15329	9mm	0,17	12		5,50€	15335	15mm	0,17	12		7,50€
15330	10mm	0,22	12		5,50€	15336	16mm	0,22	12		8,00€
15331	11mm	0,31	12		5,50€	15337	17mm	0,31	12		8,50€
15332	12mm	0,45	12		6,00€	15338	18mm	0,45	12		9,00€
15333	13mm	0,47	12		6,50€	15339	19mm	0,47	12		9,50€

SET 8 LLAVES COMBINADAS CORTAS CON TRINQUETE

54110 46,00€

0,90	-	10	840
Kg	Sub	11	11

10, 11, 12, 13, 14, 15, 17, 19mm

72°



8 PCS

DESPIECE DISPONIBLE

REF.	mm	Kg	Sub	11	€
13491	10mm	0,5	10		5,30€
13492	11mm	0,6	10		5,35€
13493	12mm	0,7	10		5,50€
13494	13mm	0,8	10		6,00€
13495	14mm	0,9	10		6,40€
13496	15mm	0,12	10		6,60€
13497	17mm	0,14	10		7,50€
13498	19mm	0,19	10		8,50€



ESTUCHE CON 6 LLAVES ARTICULADAS CON TRINQUETE

53018 119,00€

2,66 - 5 125



CROMADO



8x9,10x11, 12x13, 14x15, 16x18, 17x19mm



6 PCS

DESPIECE DISPONIBLE

REF.	mm	Kg	Sub	€
13447	8x9mm	0,1	6	16,50€
13448	10x11mm	0,15	6	17,50€
13449	12x13mm	0,25	6	20,00€
13450	14x15mm	0,3	6	23,00€
13451	16x18mm	0,35	6	28,00€
13452	17x19mm	0,4	6	29,50€

SET DE 4 LLAVES TORX ARTICULADAS CON TRINQUETE

50754 98,00€

0,82 - 20 360



CROMADO

- Cabezal articulado de 0° a 180°.
- Chicharra de 72 dientes.



E6 x E8
E10 x E12
E14 x E18
E20 x E24



4 PCS

DESPIECE DISPONIBLE

REF.	mm	Kg	Sub	€
10527	E6x8	0,1	10	13,10€
10528	E10x12	0,15	10	15,80€
10529	E14x18	0,25	10	18,00€
10530	E20x24	0,35	10	28,70€

MÓDULO DE 3 LLAVES 4 EN 1

15316 58,00€

0,85 - 10 260



CROMADO



8-9-10-11-12-13-14-15-16-17-18-19mm



3 PCS

DESPIECE DISPONIBLE

REF.	mm	Kg	€
15515	12-13mm x 8-10mm	0,13	15,50€
15516	14-15mm x 9-11mm	0,18	19,00€
15517	18-19mm x 16-17mm	0,37	22,50€

ESTUCHE CON 6 LLAVES DE VASO 12 CANTOS ARTICULADAS

51659 59,00€

1,60 - 10 240



CROMADO



8x9, 10x11, 12x13, 14x15, 16x17, 18x19mm



6 PCS

DESPIECE DISPONIBLE

REF.	Ø	Kg	Sub	€
10621	XZN 8-9	0,09	-	9,50€
10622	XZN 10-11	0,13	-	10,00€
10623	XZN 12-13	0,16	5	12,60€
10624	XZN 14-15	0,20	-	13,50€
10625	XZN 16-17	0,29	-	15,70€
10626	XZN 18-19	0,37	-	17,80€

ESTUCHE CON 4 LLAVES DE VASO TORX ARTICULADAS

50622 64,00€

1,05 - 10 320



CROMADO



E6x8, E10x12, E14x18, E20x24



4 PCS

DESPIECE DISPONIBLE

REF.	Ø	Kg	€
10617	E6x8	0,07	14,10€
10618	E10x12	0,11	15,10€
10619	E14x18	0,20	15,70€
10620	E20x24	0,34	16,20€

SET DE 21 LLAVES COMBINADAS

54079 83,00€

4,00 - 8 160
Kg SUB ff

6mm, 7mm, 8mm, 9mm, 10mm, 11mm, 12mm, 13mm, 14mm, 15mm, 16mm, 17mm, 18mm, 19mm, 20mm, 21mm, 22mm, 24mm, 27mm, 30mm, 32mm

21 PCS

CrV

SET DE LLAVES COMBINADAS

14 LLAVES

50560 38,60€

1,25 5 20 240
Kg SUB ff

54097 38,90€

1,40 - 10 570
Kg SUB ff

6, 7, 8, 9, 10, 11, 12, 13, 14, 15, 16, 17, 18, 19mm

6, 7, 8, 9, 10, 11, 12, 13, 14, 15, 16, 17, 18, 19mm

14 PCS

CrV

CINCADO

DESPIECE DISPONIBLE

CINCADO	mm	Kg	Sub	ff	€
10548	6mm	0,03	10	100	1,75€
10549	7mm	0,03	10	100	2,00€
10550	8mm	0,04	10	100	2,15€
10551	9mm	0,04	10	100	2,15€
10531	10mm	0,05	10	100	3,00€

CINCADO	mm	Kg	Sub	ff	€
10532	11mm	0,05	10	100	2,70€
10533	12mm	0,07	10	100	3,00€
10534	13mm	0,08	10	100	3,25€
10535	14mm	0,06	10	100	3,50€
10536	15mm	0,10	10	100	3,65€

CINCADO	mm	Kg	Sub	ff	€
10537	16mm	0,11	10	100	3,90€
10538	17mm	0,14	10	100	4,30€
10539	18mm	0,16	10	100	4,75€
10540	19mm	0,20	10	60	5,25€

KIT DE 7 LLAVES COMBINADAS

54120 59,00€

2,89 - 6 252
Kg SUB ff

54174 139,00€

8,70 - 2 750
Kg SUB ff

20, 21, 22, 24, 27, 30, 32mm

34, 36, 38, 41, 46, 50mm

7 PCS

6 PCS

XL

CrV

DESPIECE DISPONIBLE

DESPIECE DISPONIBLE

CINCADO	mm	Kg	Sub	ff	€
10541	20mm	0,21	60	5,55€	
10542	21mm	0,25	50	5,85€	
10543	22mm	0,25	50	7,00€	

10544	24mm	0,33	50	8,10€
10545	27mm	0,41	50	9,75€
10546	30mm	0,52	25	11,60€
10547	32mm	0,59	25	13,50€

CINCADO	mm	Kg	Sub	ff	€
16020	34mm	0,21	-	17,00€	
16021	36mm	0,25	-	19,50€	
16022	38mm	0,41	-	23,00€	
16023	41mm	-	-	26,50€	
16024	46mm	-	-	34,50€	
16025	50mm	-	-	37,50€	

SET DE 10 LLAVES CROWFOOT DE 3/8"

54187 39,30€

0,55 5 20 1800
Kg SUB ff

CrV

10, 11, 13, 14, 15, 16, 17, 18, 19, 22mm

3/8"

SET DE 8 LLAVES COMBINADAS CORTAS

50564 30,00€

0,60	5	20	600
Kg	sub	ff	



8
PCS

10, 11, 12,
13, 14, 15, 17,
19mm



CROMADO

DESPIECE DISPONIBLE

REF.	mm	Kg	sub	ff	€
10564	10	0,05	10	100	2,50€
10565	11	0,05	10	100	3,50€
10566	12	0,05	10	100	3,50€
10567	13	0,05	10	100	3,50€
10568	14	0,05	10	100	4,00€
10569	15	0,05	10	100	4,50€
10570	17	0,10	10	100	4,50€
10571	19	0,15	10	100	5,00€



SET DE LLAVES FIJAS

12 LLAVES

6x7, 8x9, 10x11, 12x13, 14x15, 16x17, 18x19, 20x22, 21x23, 24x27, 25x28, 30x32mm

12
PCS

CINCADO

51529 59,00€

2,63	-	5	200
Kg	sub	ff	

CROMADO

52973 59,00€

2,50	-	5	160
Kg	sub	ff	

DESPIECE DISPONIBLE

REF.	mm	Kg	sub	ff	€
10589	6x7	0,03	10	100	2,00€
10590	8x9	0,04	10	100	2,40€
10579	10x11	0,06	10	100	3,00€
10580	12x13	0,07	10	100	3,10€
10581	14x15	0,10	10	100	3,40€
10582	16x17	0,14	10	100	4,00€
10583	18x19	0,19	10	100	4,15€
10584	20x22	0,25	60	100	5,05€
10585	21x23	0,31	-	50	6,75€
10586	24x27	0,35	-	50	7,60€
10587	25x28	0,36	-	50	9,80€
10588	30x32	0,54	-	25	10,50€



7 LLAVES

6x7, 8x9, 10x11, 12x13, 14x15, 16x17, 18x19mm

7
PCS

CINCADO

50561 19,20€

0,69	5	20	400
Kg	sub	ff	

DESPIECE DISPONIBLE

REF.	mm	Kg	sub	ff	€
10589	6x7	0,03	10	100	2,00€
10590	8x9	0,04	10	100	2,40€
10579	10x11	0,06	10	100	3,00€
10580	12x13	0,07	10	100	3,10€
10581	14x15	0,10	10	100	3,40€
10582	16x17	0,14	10	100	4,00€
10583	18x19	0,19	10	100	4,15€



12 LLAVES

54149 60,00€

2,75	-	6	240
Kg	sub	ff	

6x7, 8x9, 10x11, 12x13, 14x15, 16x17, 18x19, 20x22, 21x23, 24x27, 25x28, 30x32mm

12
PCS



7 LLAVES

54150 23,50€

0,75	10	20	720
Kg	sub	ff	

6x7, 8x9, 10x11, 12x13, 14x15, 16x17, 18x19mm

7
PCS



DESPIECE DISPONIBLE

CINCADO	mm	Kg	sub	ff	€	CINCADO	mm	Kg	sub	ff	€	CINCADO	mm	Kg	sub	ff	€	CINCADO	mm	Kg	sub	ff	€
10589	6x7	0,03	10	100	2,00€	10580	12x13	0,07	10	100	3,10€	10583	18x19	0,19	10	100	4,15€	10586	24x27	0,35	-	50	7,60€
10590	8x9	0,03	10	100	2,40€	10581	14x15	0,10	10	100	3,40€	10584	20x22	0,25	-	100	5,05€	10587	25x28	0,36	-	50	9,80€
10579	10x11	0,06	5	100	3,00€	10582	16x17	0,14	10	100	4,00€	10585	21x23	0,31	-	50	6,75€	10588	30x32	0,54	-	25	10,50€

SET DE 8 LLAVES TIPO "C" CABEZAL REDONDO 12 CANTOS

52451 42,00€

0,93	5	20	480
Kg	sub	ff	ff

CROMADO

DESPIECE DISPONIBLE



54159 47,00€

1,05	-	10	460
Kg	sub	ff	ff

6x7, 8x9, 10x11, 12x13,
14x15, 16x17, 18x19,
20x22mm



JUEGO DE 4 LLAVES TORX PLANAS

54115 26,80€

0,35	-	10	50
Kg	sub	ff	ff

E6xE8, E10xE12,
E14xE18, E20xE24

4
PCS



SET DE LLAVES HEX, CON BOCA ABIERTA DE 6 CANTOS

54081 28,00€

0,75	-	10	750
Kg	sub	ff	ff

10 x 11 HEX, 12 x 13 HEX, 14 x 15
HEX, 16 x 17 HEX, 18 x 19 HEX

5
PCS



SET LLAVES ESTRELLA ACODADAS 12 CANTOS

12 LLAVES

CROMADO

54119 78,00€

3,20	-	6	168
Kg	sub	ff	ff

6x7, 8x9, 10x11, 12x13, 14x15,
16x17, 18x19, 20x22, 21x23,
24x27, 25x28, 30x32mm



12
PCS



DESPIECE DISPONIBLE

7 LLAVES

CINCADO

50562 23,50€

0,87	5	20	560
Kg	sub	ff	ff

6x7, 8x9, 10x11, 12x13, 14x15,
16x17, 18x19mm



7
PCS



50562



CINCADO	mm	Kg	sub	ff	ff	€
10627	6x7	0,04	10	100	2,80€	
10628	8x9	0,06	10	100	3,10€	
10629	10x11	0,08	10	100	3,65€	

mm	Kg	sub	ff	ff	€
10630	12x13	0,11	10	100	3,90€
10631	14x15	0,14	10	100	4,20€
10632	16x17	0,18	10	100	5,30€

CINCADO	mm	Kg	sub	ff	ff	€
10633	18x19	0,22	10	100	6,60€	
10634	20x22	0,43	-	50	7,80€	
10635	21x23	0,30	-	50	8,15€	

CINCADO	mm	Kg	sub	ff	ff	€
10636	24x27	0,35	-	25	8,80€	
10637	25x28	0,48	6	24	12,10€	
10638	30x32	0,73	6	25	12,70€	

MÓDULO EVA FIBRA DE CARBONO DE 4 LLAVES ACODADAS

15156 70,00€

2,05	-	10	180
Kg	sub	ff	ff

CROMADO

DESPIECE DISPONIBLE

REF.	mm	Kg	sub	ff	ff	€
15206	21x23	0,45	5	50	15,00€	
15207	24x27	0,5	5	50	16,50€	
15208	25x28	0,45	5	50	17,00€	
15209	30x32	0,67	10	50	18,00€	



4
PCS

21x23, 24x27,
25x28, 30x32mm



IVA no incluido

JBM / www.jbmcamp.com

39

MÓDULO EVA DE 6 LLAVES EXTRALARGAS

51864 64,00€

1.87	-	10	210
Kg	sub	ff	ff

10x11mm (290mmL),
12x14mm (330mmL),
13x15mm (368mmL),
16x18mm (407mmL),
17x19mm (407mmL),
22x24mm (430mmL)

DESPIECE DISPONIBLE

REF.	Ø	Kg	sub	ff	ff	€
11244	XL XZN 10x11	0,13	5			8,50€
11245	XL XZN 12x14	0,18	-			9,15€
11246	XL XZN 13x15	0,25	6			12,40€
11247	XL XZN 16x18	0,30	6			14,00€
11248	XL XZN 17x19	0,31	6			14,60€
11249	XL XZN 22x24	0,43	6			26,50€



6 PCS

52912 91,00€

1.62	-	10	210
Kg	sub	ff	ff

E6x7 (200mmL),
E8x10 (235mmL),
E11x12 (290mmL),
E14x16 (370mmL),
E18x20 (410mmL),
E22x24 (420mmL)

CROMADO

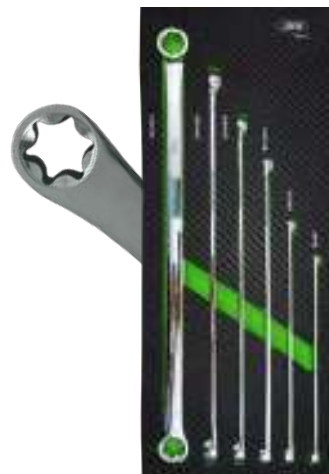

6 PCS

SET DE 14 LLAVES PIPA DE DOBLE BOCA

51528 49,00€

3.55	-	5	270
Kg	sub	ff	ff

CINCADO

REF.	mm	Kg	€
10603	8	0,07	2,10€
10604	9	0,08	2,25€
10591	10	0,09	2,50€
10592	11	0,12	2,55€
10593	12	0,16	3,15€
10594	13	0,17	3,20€
10595	14	0,20	3,35€
10596	15	0,25	4,25€
10597	16	0,30	4,50€

DESPIECE DISPONIBLE

REF.	mm	Kg	€
10598	17	0,32	4,60€
10599	18	0,43	6,00€
10600	19	0,41	6,25€
10601	20	0,45	6,50€
10602	21	0,47	7,05€



8, 9, 10, 11, 12, 13, 14, 15,
16, 17, 18, 19, 20, 21mm



14 PCS



SET DE 8 LLAVES DE TUBO

53420 72,00€

1.50	-	20	540
Kg	sub	ff	ff

CINCADO



6x7, 8x9, 10x11, 12x13, 14x15,
16x17, 18x19, 20x22mm



8 PCS

SET DE 8 LLAVES TORX EN FORMA DE "T"

53979 34,60€

1.00	-	10	180
Kg	sub	ff	ff

T10x75,
T15x75,
T20x100,
T25x100,
T30x150,
T40x150,
T45x200,
T50x200mm



SET DE 8 LLAVES ALLEN EN FORMA DE "T"

53980 34,60€

1.00	-	10	180
Kg	sub	ff	ff

H2x100,
H2.5x100,
H3x100,
H4x150,
H5x150,
H6x200,
H8x200,
H10x200



SET DE 9 LLAVES



EXTRALARGAS

53737 12,50€

0,42	10	40	1000
Kg	sub	ff	ff



90-218mm

LARGAS

53739 10,50€

0,32	10	40	1440
Kg	sub	ff	ff



86-150mm

CORTAS

53955 10,00€

0,25	10	40	1480
Kg	sub	ff	ff



72-170mm

T10, T15, T20, T25, T27, T30, T40, T45, T50

53737/53739/53955



EXTRALARGAS

53738 10,90€

0,45	10	40	1000
Kg	sub	ff	ff



9 PCS

90-220mm

LARGAS

53740 9,10€

0,37	10	40	1200
Kg	sub	ff	ff



72-170mm

CORTAS

53954 8,50€

0,25	10	40	1480
Kg	sub	ff	ff



43-97mm

1,5, 2, 2,5, 3, 4, 5, 6, 8, 10mm

53738/53740/53954

HERRAMIENTAS EN PULGADA

SET DE 17 LLAVES COMBINADAS EN PULGADA

51890 92,00€

CINCADO

17 PCS

4,45	-	4	168
Kg	sub	ff	ff



SET DE 9 LLAVES HEXAGONAL EN PULGADA

54005 14,00€

72-170mm

9 PCS

CrV

0,35	10	40	1200
Kg	sub	ff	ff

1/16", 5/64", 3/32", 1/8", 5/32", 3/16", 1/4", 5/16", 3/8"



MALETÍN DE HERRAMIENTAS 37 PIEZAS EN PULGADA

54106 89,00€

4,70	-	3	108
Kg	sub	ff	ff



CrV

1/2"

1/4"

37 PCS

CONTIENE

	1/2"	x17	5/16", 3/8", 7/16", 1/2", 9/16", 19/32", 5/8", 11/16", 3/4", 13/16", 7/8", 15/16", 1", 1-1/16", 1-1/8", 1-3/16", 1-1/4"
	1/4"	x8	3/16", 7/32", 1/4", 9/32", 5/16", 11/32", 3/8", 7/16"
	53076	x2	1/2" - 1/4"
	1/2"	x2	5", 10"
	1/4"	x1	3"
		x1	1/2"



	x1	1/4"
	x2	1/2" - 1/4"
	x1	1/4"

MALETÍN CON PUNTAS DE 208 PIEZAS

53574 47,00€

2,29	-	6	216
Kg	Sub	11	11



208 PCS
CrV

CONTIENE

25mmL x12	1,5, 2, 2,5, 3, 3,5, 4, 4,5, 5, 5,5, 6, 7, 8mm	25mmL x4	4, 6, 8, 10mm
x10	1/16, 5/64, 3/32, 7/64, 1/8, 9/64, 5/32, 3/16, 7/32, 1/4	50mmL x4	4, 6, 8, 10mm
50mmL x5	2,5, 3, 4, 5, 6mm	25mmL x4	1, 2, 3, 4mm
75mmL x5	2,5, 3, 4, 5, 6mm	50mmL x4	1, 2, 3, 4mm
25mmL x18	PH00, PH0, PH1(x5), PH2(x5), PH3(x5), PH4	25mmL x6	2, 2,5, 3, 4, 5, 6mm
50mmL x3	PH1, PH2, PH3	25mmL x6	5/64, 3/32, 7/64, 1/8, 9/64, 5/32
75mmL x3	PH1, PH2, PH3	25mmL x13	T5, 6, 7, 8, 9, 10, 15, 20, 25, 27, 30, 40, 45
25mmL x17	PZ00, PZ0, PZ1(x5), PZ2(x5), PZ3(x4), PZ4	25mmL x3	1, 2, 3mm
50mmL x3	PZ1, PZ2, PZ3	25mmL x4	0, 1, 2, 3mm
75mmL x3	PZ1, PZ2, PZ3	25mmL x3	M5, M6, M8
25mmL x14	T5, T6, T7, T8, T9, T10, T15, T20, T25, T27, T30, T35, T40, T45	25mmL x9	TS10, TS15, TS20, TS25, TS27, TS30, TS40, TS45, TS50
50mmL x7	T10, T15, T20, T25, T27, T30, T40	25mmL x12	SL2, SL2.5, SL3, SL3.5, SL4, SL4.5, SL5, SL5.5, SL6, SL6.5, SL7, SL8
75mmL x7	T10, T15, T20, T25, T27, T30, T40		
25mmL x3	6, 8, 10mm		
50mmL x3	6, 8, 10mm		

mm	x10	4, 5, 6, 7, 8, 9, 10, 11, 12, 13
"	x10	5/32, 3/16, 7/32, 1/4, 9/32, 5/16, 11/32, 3/8, 7/16, 1/2
6mm	x1	1/4"
	x1	Adaptador

ESTUCHE DE DESTORNILLADORES LARGOS Y CORTOS

52500 19,00€

0,33	-	60	720
Kg	Sub	11	11

8 PCS

CORTOS

PH00x25	SL0,4x2x25
PH0x25	SL0,4x2,5x25
PH1x25	SL0,5x3x25
	SL0,5x3,5x25
	SL0,8x4x25



53917 9,00€

0,20	5	50	950
Kg	Sub	11	11

7 PCS

LARGOS

PH00, PH0, PH1	SL1,4, SL2,0, SL2,4, SL3,0
----------------	----------------------------



ESTUCHE DE DESTORNILLADORES CON PUNTAS INTERCAMBIABLES 20 EN 1

53010 18,00€

0,72	5	20	480
Kg	Sub	11	11

11 PCS

CONTIENE

x2	PH1, PH2
x2	4x6, 5x7mm
x3	T10x15, T20x25, T30x40
x3	H4x4mm, cabeza de bola H5x5mm, cabeza de bola H6x6mm, cabeza de bola



MANGO ERGONÓMICO

SET DE 4 DESTORNILLADORES PLANOS DE GOLPEO

50902 13,00€

0,70	6	42	648
Kg	Sub	11	11

4 PCS

3", 4", 6", 8"



DESTORNILLADOR REVERSIBLE PLANO - ESTRELLA

54060 6,00€

0,15	10	60	1500
Kg	Sub	11	11

SL6x150mm
PH2x150mm



54061 6,00€

0,10	10	60	1800
Kg	Sub	11	11

SL6x100mm
PH2x100mm



DESTORNILLADOR DE IMPACTO 1/2"

53694 18,40€

1,00	6	24	936
Kg	Sub	11	11

CrV 1/2" 8 PCS

CONTIENE

1/2"	x1	PH 2x36mm, 3x36mm, 3x70mm
1/2"	x1	SL 7x36mm, 8x36mm, 8x70mm



SET DE 6 DESTORNILLADORES GO-THROUGH

54071 26,50€

1.10	-	10	270
Kg	SUB	11	11



- SL8x150mm
- SL6.5x100mm
- SL5.5x75mm
- PH3x150mm
- PH2x100mm
- PH1x75mm

X3 X3

SET DE 6 DESTORNILLADORES

54070 18,00€

0.50	-	10	360
Kg	SUB	11	11



- SL6.5x150mm
- SL5.5x125mm
- SL4x100mm
- SL3x80mm
- PH1x80mm
- PH2x100mm

x2 x4

JUEGO DE DESTORNILLADORES DE GOLPE PUNTA IMANTADA

54126 39,00€

2.75	-	4	108
Kg	SUB	11	11



12 PCS

- PH0x75mm
- PH1x75mm
- PH2x38mm
- PH2x100mm
- PH3x125mm
- PH4x150mm
- SL3,2x75mm
- SL5x75mm
- SL6x38mm
- SL6x100mm
- SL8x150mm
- SL9,5x200mm

DESTORNILLADORES CON MÓDULO EVA CARBONO

53943 21,50€

0.80	-	10	240
Kg	SUB	11	11

180mm 380mm 30mm

x7 PH4x200, PH3x150, PH2x100, PH2x38, PH1x80, PH0x120, PH1x100

53944 19,50€

0.80	-	10	240
Kg	SUB	11	11

x7 SL9x200, SL4x125, SL5x100, SL5x80, SL6x38, SL6x100, SL8x150mm

53945 18,90€

0.60	-	10	240
Kg	SUB	11	11

x7 T8x75, T9x75, T10x75, T15x75, T20x75, T25x100, T27x100



DESTORNILLADOR FLEXIBLE

52170 16,00€

0.27	12	48	672
Kg	SUB	11	11

1/4" 7 PCS

4, 5, 6, 7, 8, 10mm



SET DE 3 DESTORNILLADORES FLEXIBLES

52169 25,00€

0.45	12	48	672
Kg	SUB	11	11

3 PCS

6, 7, 8mm



DESTORNILLADOR FLEXIBLE

53575 16,00€

0.40	10	40	480
Kg	SUB	11	11

CrV 1/4" 4 PCS

500mm

4, 5, 7mm

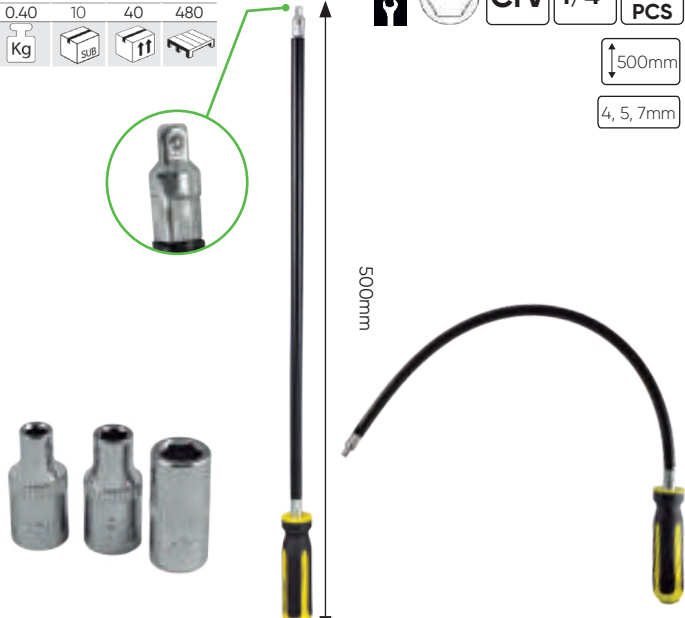

IVA no incluido

JBM / www.jbmcamp.com

DE ALUMINIO

53613 19,50€

0.55	5	30	1260
Kg	Sub	ff	ff



53614 21,50€

0.60	5	30	840
Kg	Sub	ff	ff



53615 34,60€

0.85	5	20	600
Kg	Sub	ff	ff



TUBULAR MAGNÉTICO

53616 10,40€

0.30	5	60	1260
Kg	Sub	ff	ff



53617 9,25€

0.30	5	60	840
Kg	Sub	ff	ff



53618 13,90€

0.35	5	30	600
Kg	Sub	ff	ff

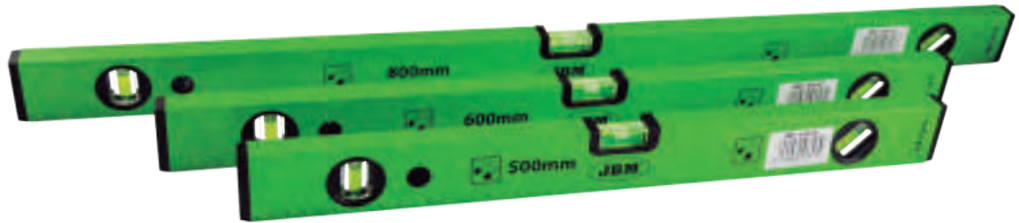

EXPOSITOR PARA NIVELES

14183 31,00€

0.80	10
Kg	ff



CINTA MÉTRICA

53027 9,00€

0.40	12	48	1500
Kg	Sub	ff	ff



53026 5,80€

0.26	12	48	2016
Kg	Sub	ff	ff



53025 3,50€

0.13	12	48	2016
Kg	Sub	ff	ff



CÚTER PROFESIONAL

51909 2,46€

0.07	24	192	2304
Kg	Sub	ff	ff

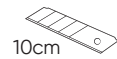

MUY RESISTENTE

MANGO ANTIDESLIZANTE



EN EXPOSITOR DE 24 UNIDADES

CANDADOS

53405 5,30€

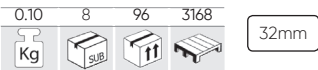

LARGOS

53403 6,50€

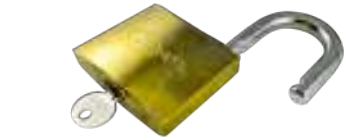
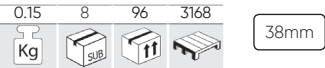

53404 6,50€

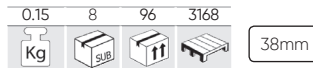

53406 8,55€

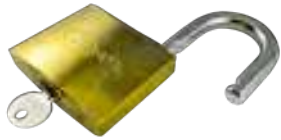
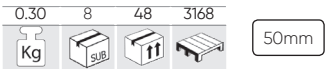

53409 9,00€

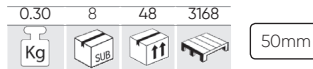

53407 12,70€

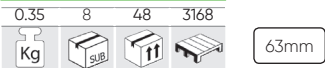

53408 19,30€

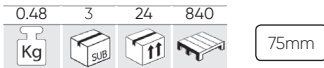

CANDADOS RESISTENTES AL AGUA

53399 3,50€



x2



53400 5,70€



53401 7,40€



53402 9,60€

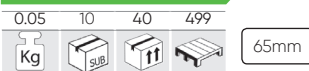

CON TAPA PROTECTORA

DESPIECE HERRAMIENTA MANUAL 2023

¿TE FALTA ALGUNA PIEZA? Descárgala en la APP de JBM

DESCÁRGATELA!

¡Descarga aquí nuestro catálogo de despieces 2023!

www.jbmcamp.com

MARTILLOS PROFESIONALES CON MANGO DE FIBRA

52182 24,00€

2 Kg

2.20 6 12 504



297mm

52184 43,00€

4 Kg

4.31 - 4 128



880mm

52185 55,00€

6 Kg

6.97 - 4 72



895mm

52186 72,00€

8 Kg

8.68 - 2 78



900mm



MARTILLOS

MARTILLO DE PEÑA

51674 7,75€

0.60 6 36 864

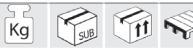

505 g



52565 11,50€

1.13 6 24 720

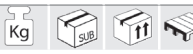

1 Kg



MARTILLO DE BOLA

51918 12,50€

1.25 6 18 432



1 Kg



51504 8,50€

0.55 4 40 800



454 g

MÓDULO DE MARTILLOS EVA - FIBRA DE CARBONO

15799 28,30€

1.35 - 10 200

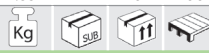

MARTILLOS PROFESIONALES ANTI-REBOTE

52180 19,00€

1,45 Kg

355mm

1.45 6 12 432

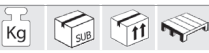

52183 26,20€

2,30 Kg

405mm

2.30 6 12 288

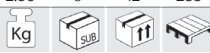

52181 22,50€

1,80 Kg

370mm

1.81 6 12 300



MARTILLOS NYLON ANTI-REBOTE

52425 33,30€

Ø 40mm

0.70 6 12 768

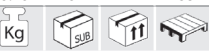

52426 52,00€

Ø 60mm

1.50 2 12 288

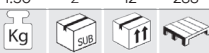

PUNTA RECAMBIO

REF.	Ø	Kg	Sub	ff	€
11212	40mm	0,02	5	100	5,00€
11213	60mm	0,08	5	50	10,60€
11214	70mm	0,11	5	100	12,50€



52427 64,00€

Ø 70mm

2.02 2 12 204



HACHAS CON MANGO DE MADERA

52188 15,50€

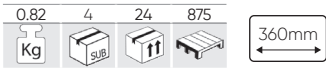

52460 16,60€

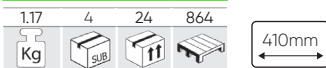

52461 25,70€

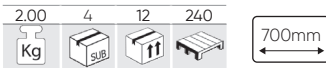

SIERRA DE ARCO CON MANGO ERGONÓMICO

52830 24,00€

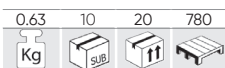

EN EXPOSITOR DE 10 UNIDADES

SIERRA DE ARCO

52831 18,00€

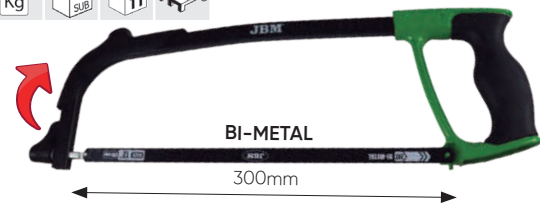
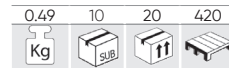

HOJA PARA SIERRA DE ARCO PARA REF. 52830 / 52831 / 51675

12060 2,50€

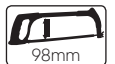
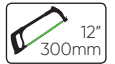
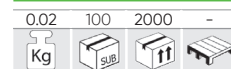

EN EXPOSITOR DE 10 UNIDADES

SET DE 5 LIMAS DE ACERO

51853 18,00€

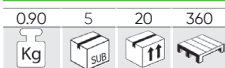

SET DE 3 ESPÁTULAS DE ACERO

51951 15,60€



- Mango ergonómico



SET 4 ESPÁTULAS DE ACERO

53339 9,50€



2, 3, 4, 6"



IVA no incluido

CINCELES

53120 6,00€

0.35 6 24 1200
Kg SUB ff

150mm

ACERO
45C



53121 7,35€

0.55 6 24 840
Kg SUB ff

250mm

53122 9,50€

0.90 6 12 720
Kg SUB ff

350mm

SET DE 4 CINCELES

53083 64,00€

1.04 10 20 960
Kg SUB ff

ACERO
SNCM+V

18x125,
21x150,
26x200,
29x250mm



SET DE 5 CINCELES

54089 17,50€

0.50 10 40 2240
Kg SUB ff

5
PCS

10, 11, 12, 14, 16mm



MÓDULO DE CINCELES Y PUNZONES

15737 45,00€

9
PCS

1.70 - 10 200
Kg SUB ff



Contiene:

Cinceles: 12x160, 16x175, 19x180mm
Cinzel de punta aguda: 6x180mm
Punzones cónicos: 6x180, 8x180, 10x180mm
Botadores cilindricos: 8x180, 10x180mm



SET DE 5 PUNZONES CÓNICOS

52049 14,00€

0.40 10 40 3840
Kg SUB ff

3, 4, 5, 6, 7mm

ACERO
45C



SET DE 6 BOTADORES

53095 20,50€

0.75 6 24 1152
Kg SUB ff

CrV

3, 4, 5, 6, 7, 8mm

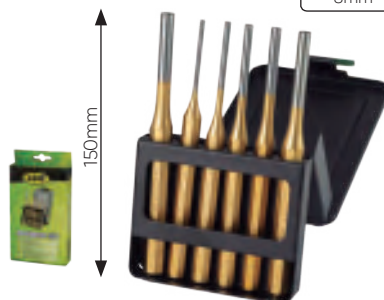

SET DE 5 BOTADORES

54099 13,80€

0.45 10 40 2240
Kg SUB ff

4, 5, 6, 7, 8mm



REMACHADORA ARTICULADA MULTIFUNCIÓN

53993 77,00€

1.95 5 20 240
Kg SUB ff

- Cabezal giratorio 360°
- Compacta, facilita el trabajo en espacios reducidos
- Diseño para trabajar con una sola mano

Contiene:

- Boquillas para remaches estándar de 2,4mm (3/32") - 3,2mm (1/8") - 4,0mm (5/32") - 4,8mm (3/16")
- Punzones para tuercas remachables M3x0.5 - M4x0.7 - M5x0.8 - M6x1
- Punzones para remaches M6x1 - M5x0,8 - M4x0,7
- 3 llaves de 5,5x8,5mm - 12x17mm - 15x19mm
- Portamandriles M6x1 - M5x0,8 - M4x0,7 - M3x0,5

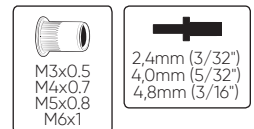

REMACHADORA TUERCA COMPACTA

200MM / 8"

52595 64,00€

1.30	-	10	280
Kg	Sub	ff	

300mm

M3, M4,
M5, M6

8"



REMACHADORA COMPACTA

200MM / 8"

52462 25,30€

0.55	5	30	600
Kg	Sub	ff	

200mm

8"



2,4mm (3/32)
3,2mm (1/8)
4,0mm (5/32)
4,8mm (3/16)

MÓDULO EVA REMACHADORA
Y REMACHES

13667 17,60€

0.83	-	10	360
Kg	Sub	ff	



REMACHADORA 300MM / 12"

52463 26,10€

0.74	5	20	240
Kg	Sub	ff	

300mm

12"



3,2mm (1/8)
4,0mm (5/32)
4,8mm (3/16)



REMACHADORA 400MM / 16"

52464 42,00€

1.25	5	10	180
Kg	Sub	ff	

400mm

16"



2,4mm (3/32)
3,2mm (1/8)
4,0mm (5/32)
4,8mm (3/16)
6,4mm (1/4)



REMACHADORA DE TUERCA

400MM / 16"

52596 114,00€

3.07	-	5	60
Kg	Sub	ff	

400mm

16"

M3, M4, M5,
M6, M8,
M10, M12



REMACHADORA TUERCA AUTOMÁTICA

440MM / 17"

52597 146,00€

3.25	-	5	80
Kg	Sub	ff	

440mm

17"

M3, M4, M5,
M6, M8,
M10, M12



MACHOS RECAMBIO PARA REMACHADORA DE TUERCA REF. 52595, 52596, 52597



REF.	DESCRIPCIÓN	Kg	ff	€
13226	M3	0,03	100	4,50€
13227	M4	0,04	100	4,50€
13228	M5	0,04	100	4,50€
13229	M6	0,04	50	4,50€

REF.	DESCRIPCIÓN	Kg	ff	€
13230	M8	0,04	50	4,50€
13231	M10	0,05	100	4,50€
13232	M12	0,05	100	4,50€

IVA no incluido

JBM / www.jbmcamp.com

49

REMACHADORA DE EMPUJE 10"/250mm

53331 31,80€

0,80	5	20	280
Kg	Sub	ft	mm

250mm 10"

2,4mm (3/32)
3,2mm (1/8)
4,0mm (5/32)
4,8mm (3/16)
6,4mm (1/4)



REMACHADORA DE ACORDEÓN 8"/ 200mm

53332 34,50€

1,65	5	10	280
Kg	Sub	ft	mm

200mm 8"

2,4mm (3/32)
3,2mm (1/8)
4,0mm (5/32)
4,8mm (3/16)



SET DE REMACHADORA + REMACHES PLÁSTICOS

52609 29,00€

0,45	5	20	300
Kg	Sub	ft	mm



Ø 6,6mm x 17,2mm (10 u.)
Ø 6,3mm x 25,2mm (10 u.)
Ø 5mm x 17,2mm (10 u.)
Ø 5mm x 15,8mm (10 u.)



REMACHES PLÁSTICOS

REF.	Ø	Kg	Sub	ft	mm	€
13674	6x19,3mm	0,01	25	1.000	0,50€	
13675	6x17,8mm	0,01	25	1.000	0,50€	
13676	6x25,5mm	0,01	25	1.000	0,50€	
13677	6x24,5mm	0,01	25	1.000	0,50€	
13678	6x24mm	0,01	25	1.000	0,50€	

REMACHADORA NEUMÁTICA

52575 119,00€

1,75	5	10	140
Kg	Sub	ft	mm



2,4mm (3/32), 3,2mm (1/8)
4,0mm (5/32), 4,8mm (3/16)

- Tracción: 1586LBS / 720 KGS.
- Largo de varilla: 9/16" - 14mm.
- Max. apriete 60FT LB / 23-69NM.
- Consumo aire medio: 0,03CFM/0,86L/Min.
- Entrada de aire: 1/4".

- Contiene:
- Cubeta trasera receptora
 - 2 Multiherramientas
 - Enganche rápido
 - Juntas tóricas

0,50€
0,50€
0,50€
0,50€
0,50€



REMACHES DISPONIBLES EN PÁG. 51,319

CARRACA 72 DIENTES CON VASOS

54030 18,80€

0,35	6	36	1008
Kg	Sub	ft	mm

1/4"

4, 5, 6, 7, 8, 9, 10, 11, 12, 13mm



54031 19,30€

0,35	6	36	864
Kg	Sub	ft	mm

1/4"

4, 5, 6, 7, 8, 9, 10, 11, 12, 13mm



54028 28,00€

1,30	4	24	432
Kg	Sub	ft	mm

1/2"

10, 11, 12, 13, 14, 15, 16, 17, 18, 19mm



54029 28,00€

1,25	4	24	432
Kg	Sub	ft	mm

1/2"

10, 11, 12, 13, 14, 15, 16, 17, 18, 19mm



SET DE 3 CARRACAS MINI

53671 41,00€

0.85	-	10	470
Kg	SUB	ff	

- Incluye:
1 carraca mini de 1/4".
1 carraca mini de 1/2".
1 carraca mini de 3/8".

PRESENTACIÓN
EN EVA



72 3
PCS



SET DE REPARACIÓN CARRACA MINI DE 1/2"	SET DE REPARACIÓN CARRACA MINI DE 3/8"	SET DE REPARACIÓN CARRACA MINI DE 1/4"
15140 13,50€	15139 12,00€	15138 10,50€
0.20 50 Kg SUB ff	0.15 50 Kg SUB ff	0.10 50 Kg SUB ff

CARRACA 72 DIENTES

CROMADA

CINCADA

54022 9,95€

0.15	12	36	2268
Kg	SUB	ff	

1/4" 145mm



54018 9,85€

0.15	12	36	2016
Kg	SUB	ff	

1/4" 145mm



54023 13,50€

0.30	12	24	1440
Kg	SUB	ff	

3/8" 200mm

54021 13,50€

0.60	12	24	1440
Kg	SUB	ff	

3/8" 200mm

54024 17,90€

0.60	12	24	960
Kg	SUB	ff	

1/2" 255mm

54019 17,90€

0.60	12	24	864
Kg	SUB	ff	

1/2" 255mm



EN EXPOSITOR
DE 12 UNIDADES



EN EXPOSITOR
DE 12 UNIDADES

CARRACA DE 72 DIENTES CINCADA

52207 24,20€

0.05	12	240	8400
Kg	SUB	ff	

1/4"

85mm



EN EXPOSITOR
DE 12 UNIDADES

CARRACA RECTA DE 72 DIENTES

54083 9,75€

0.14	12	24	2592
Kg	SUB	ff	

1/4"



54084 13,10€

0.30	12	24	1440
Kg	SUB	ff	

3/8"

54085 17,80€

0.60	12	24	960
Kg	SUB	ff	

1/2"

EN EXPOSITOR
DE 12 UNIDADES

CARRACA RECTA COMPACTA DE 72 DIENTES

54086 9,25€

0.10	12	24	2592
Kg	SUB	ff	

1/4"

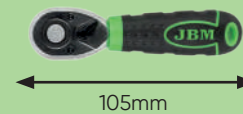

105mm

54087 17,30€

0.50	12	24	1008
Kg	SUB	ff	

1/2"



173mm

EN EXPOSITOR
DE 12 UNIDADES

IVA no incluido



www.jbmcamp.com

CARRACA DE 72 DIENTES ARTICULADA

52587 39,90€

0,16 12 144 3456



1/4" 175mm

51305 28,90€

0,31 12 48 816



1/2" 170mm



52588 45,00€

0,17 12 144 3456



EN EXPOSITOR DE 12 UNIDADES

1/2" 175mm

51306 28,10€

0,30 12 48 816



EN EXPOSITOR DE 12 UNIDADES

1/4" 175mm

CARRACA DE 72 DIENTES DE CABEZAL GIRATORIO

51405 21,10€

0,58 12 24 -



1/4" 145mm



51406 29,20€

0,66 12 24 864



1/2" 280mm



EN EXPOSITOR DE 12 UNIDADES

CARRACA ARTICULADA EXTENSIBLE DE 1/2" 72 DIENTES

52197 36,30€

1,04 6 12 480



350-490mm

1/2"



ROTACIÓN 180°

MANGO EXTENSIBLE



EN EXPOSITOR DE 6 UNIDADES

CARRACA EXTENSIBLE 72 DIENTES

53346 18,00€

0,25 6 12 -



1/4" 150-200mm

51307 29,70€

0,92 6 12 456



1/2" 305-445mm



- Acero forjado con tratamiento térmico.

EXTENSIBLE

MANGO EXTENSIBLE



EN EXPOSITOR DE 6 UNIDADES



EN EXPOSITOR DE 6 UNIDADES

CARRACA ARTICULADA EXTRA LARGA DE 72 DIENTES

53886 20,30€

0.27	10	40	1680
Kg	Sub	11	11

1/4" 305mm



PUNTA RECAMBIO
1/4" PARA REF. 53886

15149	0.05	100
5,00€	Kg	11

53887 30,30€

0.68	10	20	700
Kg	Sub	11	11

3/8" 457mm

PUNTA RECAMBIO
3/8" PARA REF. 53887

15147	0.10	100
5,00€	Kg	11

53888 37,90€

1.27	4	16	480
Kg	Sub	11	11

1/2" 609mm

PUNTA RECAMBIO
1/2" PARA REF. 53888

15148	0.20	100
5,00€	Kg	11



CARRACA EXTRA LARGA DE 72 DIENTES

53883 18,40€

0.27	10	40	1680
Kg	Sub	11	11

1/4" 305mm



PUNTA RECAMBIO
1/4" PARA REF. 53883

15149	0.05	100
5,00€	Kg	11

53884 30,20€

0.61	10	20	700
Kg	Sub	11	11

3/8" 457mm

PUNTA RECAMBIO
3/8" PARA REF. 53884

15147	0.10	100
5,00€	Kg	11

53885 35,70€

1.25	4	16	480
Kg	Sub	11	11

1/2" 609mm

PUNTA RECAMBIO
1/2" PARA REF. 53885

15148	0.20	100
5,00€	Kg	11



CARRACA FLEXIBLE DE 72 DIENTES DE 3/8"

51801 62,00€

0.56	-	40	160
Kg	Sub	11	11

500mm 3/8"

- Muy útil en lugares de difícil acceso.



CON CABEZAL GIRATORIO

SE ACCIONA ROTANDO EL MANGO

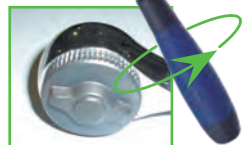

LLAVE EN CRUZ UNIÓN SOLDADA

51661 12,00€

1.17	5	20	480
Kg	Sub	11	11

355mm 17, 19, 21mm 1/2"



52881 17,00€

1.40	-	10	420
Kg	Sub	11	11

400mm 17, 19, 21, 22mm 1/2"



52880 42,00€

3.75	-	5	100
Kg	Sub	11	11

700mm 24, 27, 32mm 3/4"

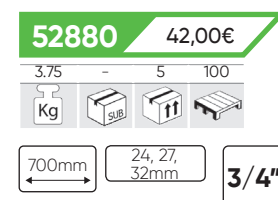

MANGO EN T CON MANIJA DESLIZANTE

53478 4,55€

0,50	5	100	1200
Kg	Sub	11	11

1/4" 115mm

53468 8,50€

0,35	6	48	600
Kg	Sub	11	11

1/2" 250mm

53481 27,40€

2,85	-	5	300
Kg	Sub	11	11

1" 550mm



53479 6,40€

0,15	5	50	300
Kg	Sub	11	11

3/8" 200mm

53480 19,90€

1,35	5	10	440
Kg	Sub	11	11

3/4" 460mm



MANERALES CON CABEZAL ARTICULADO

52524 51,00€

3,60	3	6	180
Kg	Sub	11	11

3/4"

1.020mm



52526 28,40€

1,65	5	10	400
Kg	Sub	11	11

1/2"

600mm



1/2" 11945



1/2" 11946



3/4" 11947

52525 13,80€

0,85	10	20	1400
Kg	Sub	11	11

1/2"

430mm



REF.	"	PARA	Kg	Sub	11	€
11945	1/2"	52526	0,15	25	100	7,00€
11946	1/2"	52525	0,51	100	300	4,50€
11947	3/4"	52524	0,60	10	40	19,00€

SET DE BARRAS DE EXTENSIÓN DE 1/4"

51447 16,00€

0,34	5	20	960
Kg	Sub	11	11



1/4"

50, 75, 100, 152, 227mm

DESPIECE DISPONIBLE

REF.	mm	Kg	Sub	11	€
14026	50mm	0,03	5	100	5,50€
14027	75mm	0,04	-	50	5,60€
14028	100mm	0,06	5	100	7,00€
14029	152mm	0,08	-	50	8,50€
14030	227mm	0,11	-	50	9,50€



SET DE BARRAS DE EXTENSIÓN DE 1/4" CON CABOTA REDONDA

51805 17,00€

0,33	4	20	640
Kg	Sub	11	11



1/4"

50, 75, 100, 152, 227mm

DESPIECE DISPONIBLE

REF.	mm	Kg	Sub	11	€
12995	50mm	0,03	5	100	7,00€
12996	75mm	0,04	20	100	7,00€
12997	100mm	0,06	20	100	7,50€
12998	152mm	0,08	5	100	9,00€
12999	227mm	0,11	5	100	9,50€



SET DE BARRAS DE EXTENSIÓN DE 1/2" CON CABOTA REDONDA

51448 52,00€

2,38	-	5	270
Kg	Sub	11	11



1/2"

50, 125, 250, 380, 510mm

DESPIECE DISPONIBLE

REF.	mm	Kg	Sub	11	€
14978	50mm	0,09	5	100	7,50€
14979	125mm	0,21	5	50	9,00€
14980	250mm	0,40	5	25	13,00€
14981	380mm	0,62	5	20	22,50€
14982	510mm	0,83	5	10	27,50€



BARRA EXTENSIÓN DE 1/2" CON CABOTA REDONDA

51479 31,80€

0,65	12	24	1056
Kg	Sub	ff	ff

260-410mm 1/2"



EN EXPOSITOR DE 12 UNIDADES



6 POSICIONES

PINZA FLEXIBLE CON PUNTA DE 4 GARRAS

51526 9,80€

0,10	12	144	2016
Kg	Sub	ff	ff

500mm Ø 20mm

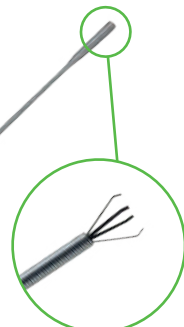

20mm

PUNTA IMANTADA FLEXIBLE CON LED

52473 9,90€

0,18	10	60	1800
Kg	Sub	ff	ff

x1 545mm Ø 15mm



PUNTA IMANTADA EXTENSIBLE

52472 4,90€

0,15	12	108	4320
Kg	Sub	ff	ff

Ø 10mm 135-600mm



2,5 Kg

PUNTA IMANTADA FLEXIBLE

51525 9,80€

0,14	10	60	1440
Kg	Sub	ff	ff

500mm Ø 7mm



EXTRAFINA

0,5 Kg

PUNTA IMANTADA CON LED

51272 7,50€

0,05	12	72	1512
Kg	Sub	ff	ff

90-810mm Ø 15mm

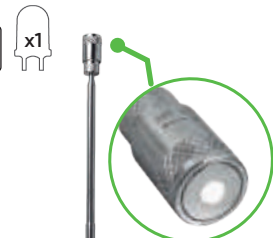

EN EXPOSITOR DE 12 UNIDADES

KIT DE HERRAMIENTAS MAGNÉTICAS DE RECOGIDA - 5 PIEZAS

15706 31,00€

0,55	-	10	240
Kg	Sub	ff	ff

5 PCS LED 360°



MAGNETIZADOR / DESMAGNETIZADOR

53225 3,50€

0,10	12	96	2880
Kg	Sub	ff	ff

ABS



ESPEJO DE INSPECCIÓN TELESCÓPICO ARTICULADO

52468 5,90€

0,09	12	48	2688
Kg	Sub	ff	ff

280-445mm



Ø 50MM

NAVAJA CON SISTEMA CORTA CINTURONES Y ROMPE CRISTALES

52786 14,60€

0.16 12 60 2100



CON SEGURO ANTICIERRE

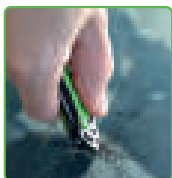

CORTATUBOS

52878 11,20€

0.22 10 50 1500



3-32mm



52879 10,10€

0.24 10 50 1500



3-35mm



53517 9,50€

0.13 10 60 600



Ø max: 30mm



52877 15,80€

0.43 6 48 624



Ø max: 42mm



52878



52879



REF.	DESCRIPCIÓN	PARA	Kg	€
12964	Rueda de acero	52878	0,01	1,50€
12965	Rueda de acero	52879	0,01	2,00€

CURVADORA DE TUBO 6-8-10MM

52905 28,00€

0.50 6 24 360



6, 8, 10mm



TUBOS DE ALUMINIO, COBRE Y ACERO



GRADOS MARCADOS



CUCHILLO PELACABLES

53591 5,50€

0.10 10 100 -



↑ 28mm
↓ 8mm



8-28mm

- Rango de corte: 8-28mm.
- Largo del producto: 170mm.
- Largo de la cuchilla: 20mm.
- Profundidad del gancho: 5mm.



ALICATES PELACABLES MINI

53411 5,00€

0.05 12 120 -



127mm



53411

53412 4,00€

0.05 12 120 -



94mm



53412

ALICATE PARA EXTRACCIÓN DE GRAPAS DE CARROCERÍA

53385 19,30€

0.15 6 54 1026



CORTAR



EXTRAER



BRIDAR



- PUNTA EN ÁNGULO:
- Diseñado para extraer / cortar grapas / clips fácilmente y sin daño.
 - Permite un fácil acceso a espacios reducidos.

ALICATE PARA TERMINALES CON PUNTA INTERCAMBIABLE

54254 43,00€

1.10 5 20 300



Incluye 7 piezas:

- Alicates de 9"
- Punta de 0,15-6mm²
- Punta de 10-35mm²

- Punta de 0,5-6mm²
- Punta de 0,5-10mm²
- Punta de 0,5-4mm²
- Destornillador PH2x150



HERRAMIENTA PELA-CABLES AUTOAJUSTABLE

51972 12,00€

0,08-6mm

0.25 10 100 1000



- Para pelar cables individual o múltiple, con secciones desde 0,25 a 2,5mm².
- Ajuste automático del grueso de decapado para las diferentes secciones.
- Posibilidad de pelar varios cables a la vez con sección de 2,5mm² como máximo.
- Posibilidad de pelar cable individual a partir de 0,25mm² de sección.
- No provoca daños en el hilo conductor.
- Alta durabilidad.



ALICATE CORTACABLES

53604 118,00€

Sección de corte max. Ø 550 mm²

3.70 - 5 120



800mm

53603 45,00€

Sección de corte max. Ø 250 mm²

1.75 - 5 300



550mm

53602 30,50€

Sección de corte max. Ø 125 mm²

0.60 - 5 300



360mm



53602 53603 53604

ALICATES PARA TERMINALES

PARA TERMINALES AISLADOS

52761 8,00€

9"

0.25 12 72 1800



53932 8,00€

9"

0.25 12 72 1296



MÓDULO EVA PELACABLES Y TERMINALES

13669 18,00€

0.61 10



PARA TERMINALES NO AISLADOS

52762 9,00€

8 - 3/4"

0.25 12 72 1800



TIJERAS

52152 13,50€

ACERO INOXIDABLE

145mm

0.08 12 96 1920

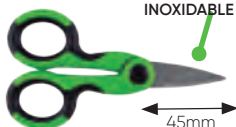

45mm

CORTAVARILLAS

52955 19,80€

0.77 - 20 200



12" 300mm HRC 30 Ø 4-5mm

52957 23,80€

1.47 - 12 360



18" 450mm HRC 30 Ø 6-8mm

52959 42,00€

3.78 - 5 100



30" 750mm HRC 30 Ø 10-13mm

52960 46,00€

5.15 - 5 105



36" 900mm HRC 30 Ø 12-16mm

52956 19,60€

0.95 - 20 200



14" 350mm HRC 30 Ø 5-7mm

52958 28,20€

2.40 - 8 210



24" 600mm HRC 30 Ø 8-10mm



52955 52956 52957 52958 52959 52960

ALICATES SEEGER BOCA RECTA

PARA INTERIORES

53549 14,30€

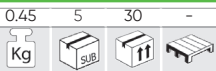

13" 330mm



52964 9,45€

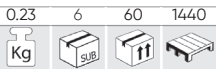

9" 225mm

51018 7,05€

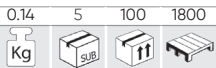

7" 180mm

PARA EXTERIORES

53547 14,70€

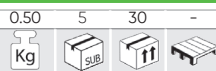

13" 330mm



52966 9,45€

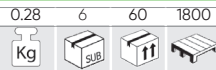

9" 225mm

51017 6,80€

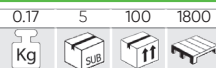

7" 180mm

ALICATES SEEGER BOCA CURVA

PARA INTERIORES

53550 14,70€

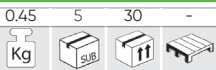

13" 330mm



52965 9,20€



9" 225mm

51021 7,05€

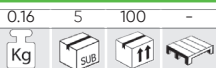

7" 180mm

PARA EXTERIORES

53548 15,60€

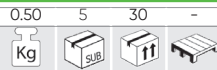

13" 330mm



52967 9,40€

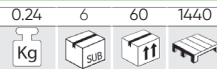

9" 225mm

51020 6,65€



7" 180mm

MÓDULO EVA DE ALICATES SEEGER 8"

15454 35,40€



REF.	Ø	Kg	€
15707	ALICATE SEEGER PARA INTERIORES BOCA RECTA 8"	0,21	10,00€
15708	ALICATE SEEGER PARA EXTERIORES BOCA RECTA 8"	0,22	10,00€
15709	ALICATE SEEGER PARA INTERIORES BOCA CURVA 8"	0,21	10,00€
15710	ALICATE SEEGER PARA EXTERIORES BOCA CURVA 8"	0,22	10,00€



8"

MALETÍN CON ALICATES SEEGER CON PUNTA INTERCAMBIABLE

53389 31,50€



Ángulo de puntas: 90° / 45° / 15° / 0°

10"

- Contiene:
- Alicate interno.
 - Alicate externo.
 - 16 puntas de diferentes ángulos.
 - 8 tornillos.



58

JBM

www.jbmcamp.com

ALICATE DE PICO DE LORO

52052 53,00€

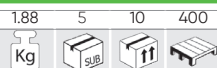

50567 9,60€

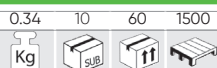

IVA no incluido

ALICATE EXTRALARGO

RECTO

52846 37,80€

0.40 - 60 1500

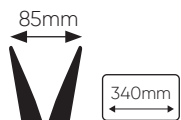

CURVADO 45°

52847 41,00€

0.40 - 60 1500

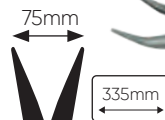

SET ALICATES PUNTA DE 0°, 45° Y 90°

52272 24,60€

1.10 5 10 320

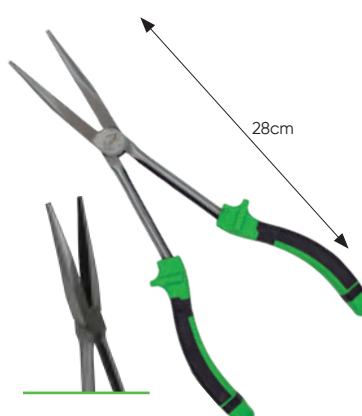
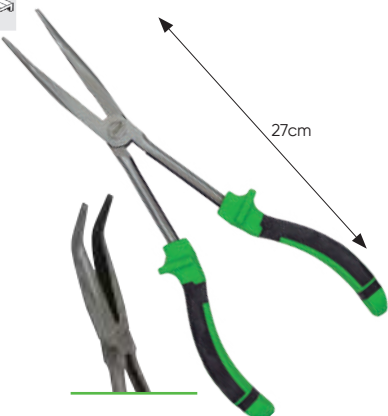

SET DE 5 ALICATES EN ESTUCHE

51812 46,00€

1.65 - 10 240



MULTIUSOS

52412 5,00€

0.09 24 144 5760



105mm



CONTIENE

- x2 destornillador plano
- x1 punta estrella
- x1 abrebotellas
- x1 abrelatas
- x1 lima 25mm
- x1 hojas de sierra 40mm
- x1 hoja de corte 40mm

IVA no incluido



www.jbmcamp.com

ALICATE PARA ABRAZADERAS

53390 34,50€

1.00	10	20	320
Kg	sub	ff	ff



SET DE RECAMBIOS PARA REF. 53390

14180 7,90€

0.01	100
Kg	ff

51995 24,50€

0.53	5	40	360
Kg	sub	ff	ff



SET DE RECAMBIOS PARA REF. 51995

14179 8,50€

0.01	100
Kg	ff

ALICATE PARA ABRAZADERAS DE TUBOS DE ESCAPE

53396 18,30€

0.50	5	50	-
Kg	sub	ff	ff



ALICATE ESPECIAL ABRAZADERAS TUBO TIPO CLIC-R

52791 18,00€

0.25	5	50	1500
Kg	sub	ff	ff



- Para el tipo de Clic y Clic-R (tipo aro).

ALICATE UNIVERSAL

53911 8,80€

0.20	6	60	1440
Kg	sub	ff	ff

160mm

6"

53967 10,20€

0.30	6	60	1440
Kg	sub	ff	ff

200mm

8"

54015 10,20€

0.20	6	60	1920
Kg	sub	ff	ff

180mm

7"

CrV



ALICATE DE PUNTA ESPECIAL TERMINALES

53976 9,00€

0.20	6	60	1440
Kg	sub	ff	ff

160mm

6"

CrV



ALICATE CORTE DIAGONAL

53905 7,30€

0.20	6	60	1440
Kg	sub	ff	ff

6" 160mm

53906 8,65€

0.20	6	60	1440
Kg	sub	ff	ff

7" 184mm

CrV



ALICATE PUNTA ALARGADA

53908 7,25€

0.15	6	60	1440
Kg	sub	ff	ff

6" 160mm

CrV

53909 9,70€

0.20	6	60	1440
Kg	sub	ff	ff

8" 200mm



SET DE ALICATES PARA ABRAZADERAS

52050 98,00€

3,24 - 4 60



- Alicates para abrazaderas que permiten la extracción de abrazaderas autoajustables de plástico y/o metal de diámetros 148mm a 47mm.
- Alicates para abrazaderas de mordaza pivotante con ranura en "+".
- Alicates para abrazaderas de mordaza giratoria.
- Alicates para abrazaderas de banda plana. La mordaza gira 360° para agarrar en cualquier ángulo. Para abrazaderas modernas.
- Alicates para extracción de tubos. Muy útiles para la fácil extracción de tubos de vacío y combustible de 5/32" hasta 1/2".
- Alicates de anillo click-R. Uso para aflojar y reajustar abrazaderas reajustables de tipo click-R.



REF.	DESCRIPCIÓN	Kg	SUB	ff	€
13707	alicate para abrazaderas elásticas con punta rotativa	0,25	10	40	14,00€
13708	alicate para abrazaderas elásticas	0,25	10	40	14,00€
13709	alicate para abrazaderas elásticas con punta recta	0,24	10	40	14,00€
13710	alicate para abrazaderas elasticas 45°	0,21	10	40	14,00€

REF.	DESCRIPCIÓN	Kg	SUB	ff	€
52791	alicate para abrazaderas clic y clic-r	0,27	10	50	18,00€
13712	alicate para la extracción de tubos	0,21	10	40	14,00€
51995	alicate con cable para abrazaderas	0,59	5	40	24,50€



ALICATE PARA ABRAZADERA DE FUELLE DE PALIER

52619 23,10€

0,55 6 36 648

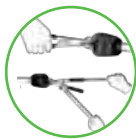

0-20mm

- Agujeros de 1/2" en los mangos para usar con llave.



52812 65,00€

0,85 5 20 500



- Adaptador de 3/8" para apriete con carraca.

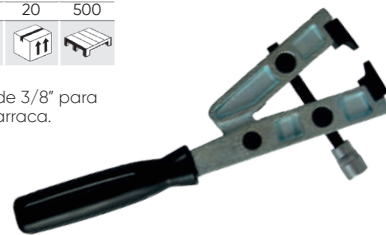

ALICATE PARA TUBO DE COMBUSTIBLE

53487 16,70€

0,30 10 40 960



Audi / VW, Fiat, GM, Mercedes



ALICATE ABRAZADERA

52508 38,40€

0,37 10 50 800



0-38mm



52509 36,20€

0,39 10 50 800



22-55mm



PESTAÑA DE BLOQUEO

240mm



SET DE GANCHOS, PUAS Y PALANCAS ANTI-MARCAS

54142 15,20€

0.10	6	48	1344
Kg	sub	ff	ff

Herramientas para la extracción, limpieza y trabajo con clips plásticos, juntas, cables, conectores eléctricos, etc.
- No daña materiales blandos
- No rasca la pintura

6 PCS

Contiene:
2 puntas en gancho
2 puntas rectas
2 puntas en ángulo
6 puntas con palancas

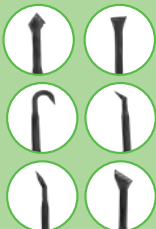

SET DE 2 GANCHOS PARA EXTRAER JUNTAS TORICAS

52852 6,80€

0.06	25	100	3200
Kg	sub	ff	ff

- Para extracción de juntas tóricas.



JUEGO DE 12 SACABOCADOS

52885 18,00€

1.10	5	20	600
Kg	sub	ff	ff

3, 4, 5, 6, 7, 8, 9, 10, 12, 14, 16, 19mm

12 PCS

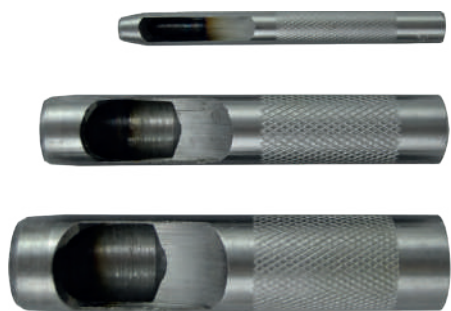

CEPILLO METÁLICO

52760 4,10€

0.09	6	120	2160
Kg	sub	ff	ff



ALICATES PARA FRENO DE TAMBOR

52625 9,00€

0.35	6	48	1824
Kg	sub	ff	ff



- Para extraer e instalar molles de mordazas en frenos de tambor.

ALICATE ESPECIAL PARA CONTRAPESAS

51355 19,00€

0.45	5	50	-
Kg	sub	ff	ff

- Extrae fácilmente y sustituye la contrapesa.
- Corta y dobla con facilidad.
- Hecho de acero templado.
- Incluye mango ergonómico.
- Con muelle automático en abierto en el asa para facilitar su operación.



GRAPADORA INDUSTRIAL

53589 12,00€

0.55	20	40	920
Kg	sub	ff	ff

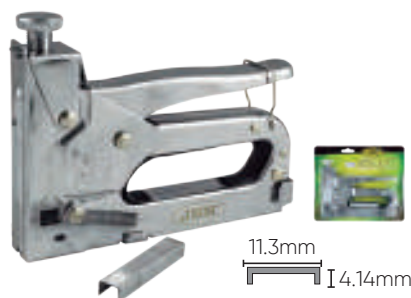

1008J-1

PAQUETE DE 1000 GRAPAS PARA REF. 53589

14167 2,50€

0.10	100
Kg	ff

ALICATE SACABOCADOS

52638 9,95€

0.35	5	50	1800
Kg	sub	ff	ff

Ø 2, 2.5, 3, 3.5, 4, 4.5mm



SET DE LLAVES DE GANCHO

53654 81,00€

1.40 - 5 180



- Kit compuesto por 3 llaves de gancho, 3 adaptadores y 2 pasadores intercambiables.
- Su combinación permiten trabajar con tuercas con diámetro desde 35mm a 120mm.

8
PCS

35-60, 60-90,
90-120mm

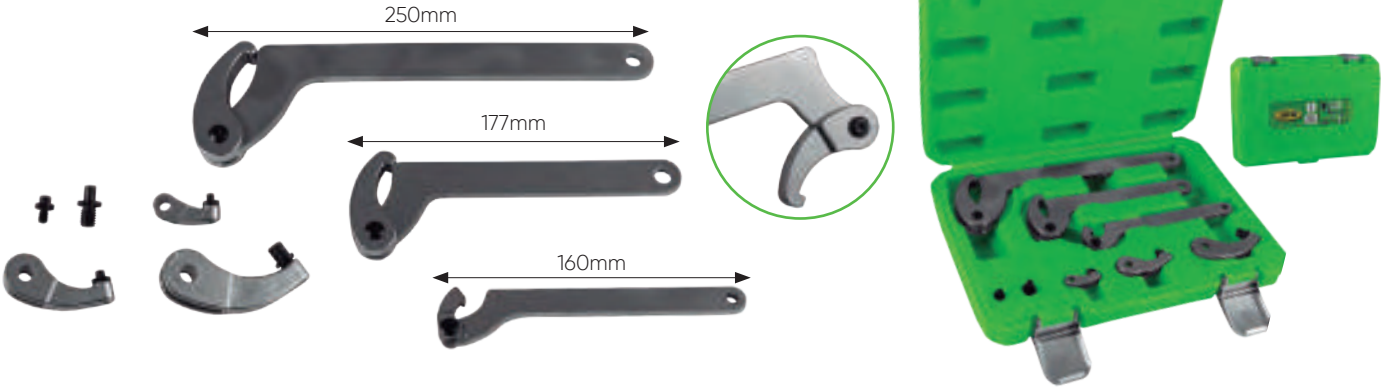

MALETÍN CON LLAVES ROMPETUERCAS

53524 51,00€

1.70 5 10 320



9-12, 12-16,
16-22, 22-27mm

4
PCS



DESPIECE DISPONIBLE

REF.	DESCRIPCIÓN	Kg	SUB	ff	€
14049	9-12mm	0,11	50	8,00€	
14050	12-16mm	0,2	50	10,50€	
14051	16-22mm	0,44	5	20	18,00€
14052	22-27mm	0,65	5	20	19,50€



LLAVE INGLESA

MODELO 3

53639 28,60€

0.15 6 96 576



6" 150mm

53640 34,40€

0.28 6 72 504



8" 200mm

53641 41,00€

0.50 6 36 1151



10" 250mm



53642 54,00€

0.83 6 10 1200



12" 300mm

53643 92,00€

1.53 - 12 336



16" 400mm



MODELO 1

51798 39,60€

1.90 3 12 480



18" 53mm

52424 64,00€

3.75 - 5 250



24" 62mm



MODELO 2

51795 9,00€

0.28 6 60 3600



8" 22mm

51796 14,00€

0.48 6 36 2400



10" 28mm

51797 18,00€

0.71 6 24 960



12" 37mm



LLAVE STILLSON

52235 11,00€

0,90 6 24 1140



12" 300mm 50mm

52236 13,30€

1,09 6 24 760



14" 350mm 60mm

52237 18,10€

1,75 4 12 720



18" 450mm 70mm

52238 24,90€

2,50 2 8 600



24" 600mm 75mm

53210 48,00€

4,95 - 4 96



36" 915mm 100mm



LLAVE STILLSON ALUMINIO

53070 16,20€

0,68 6 24 900



12" 270mm

53071 26,10€

0,92 4 12 900



14" 320mm

53072 31,60€

1,35 4 12 900



18" 410mm

53073 50,00€

2,05 2 8 1000



24"



SARGENTOS 9 TAMAÑOS

52349 22,10€

1,25 - 10 480



90x200mm

52354 34,40€

2,41 - 6 300



120x500mm

52350 22,60€

1,41 - 10 540



90x300mm

52355 36,60€

2,62 - 4 300



120x600mm

52351 25,40€

1,60 - 10 480



90x400mm

52357 54,00€

4,60 - 5 125



150x800mm

52352 32,40€

1,99 - 10 360



120x300mm

52358 63,00€

5,35 - 5 120



150x1.000mm

52353 33,40€

2,10 - 10 350



120x400mm



52351
52352
52355
52357

52349
52350
52353
52354
52358



MOBILIARIO DE TALLER

- 66 CARROS DE HERRAMIENTAS
- 75 MÓDULOS DE HERRAMIENTAS
- 80 ACCESORIOS / RECAMBIOS PARA CARROS
- 81 ARMARIOS
- 81 ACCESORIOS PARA MESAS
- 82 MESAS DE TRABAJO
- 84 CAJAS DE HERRAMIENTAS
- 85 TABURETES / CAMILLAS
- 86 YUNQUES / TORNILLOS DE BANCO

CARRO DE HERRAMIENTAS 12 CAJONES

53939 1.280,00€

53868 1.090,00€

172
PCS

98.70 - 1 4

Kg	Sub	ff	
----	-----	----	--

83.50 - 1 4

Kg	Sub	ff	
----	-----	----	--

CON
DOTACIÓN

VACÍO

ARMARIOS

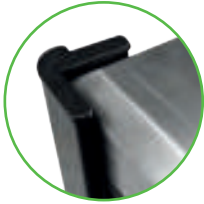

PROTECTOR LATERAL



SISTEMA DE CIERRE CON LLAVE

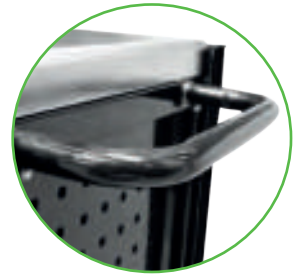

PESTAÑA DE CIERRE INDIVIDUAL POR CAJÓN

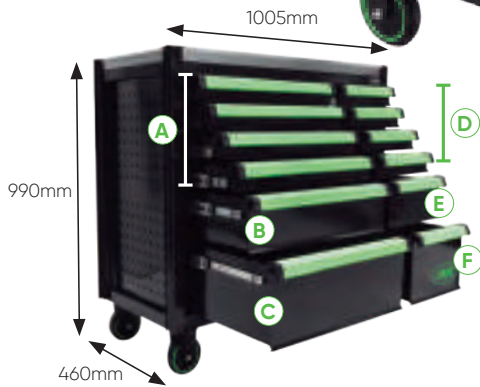

CON MÓDULOS EVA:
SET DE 4 MÓDULOS EVA
ACABADO EN FIBRA DE CARBONO

53708 325,00€

15.20 - 1 24

Kg	Sub	ff	
----	-----	----	--

ACCESORIOS
Y RECAMBIOS
página 80

MEDIDAS INTERIOR 1A COLUMNA

CAJONES PEQUEÑOS (x4)



CAJÓN MEDIANO (x1)



CAJÓN GRANDE (x1)



MEDIDAS INTERIOR 2A COLUMNA

CAJONES PEQUEÑOS (x4)



CAJÓN MEDIANO (x1)



CAJÓN GRANDE (x1)



Módulo 1: **14296** 118,00€



Módulo 2: **14297** 87,00€

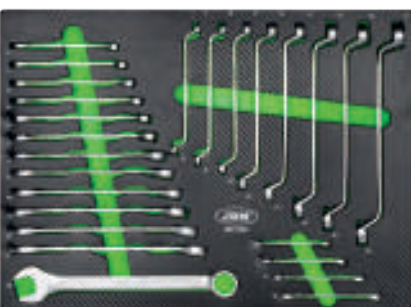

Módulo 3: **14298** 51,50€



Módulo 4: **14299** 87,00€



CARRO DE HERRAMIENTAS 7 CAJONES - XL

53912 1.280,00€	53869 990,00€	53913 1.280,00€	53870 990,00€	199 PCS
74,50 - - 4 CON DOTACION	74,50 - 1 4 VACIO	74,50 - - 4 CON DOTACION	74,50 - 1 4 VACIO	

SISTEMA DE CIERRE CON LLAVE

SUPERFICIE DE TRABAJO DE ACERO INOXIDABLE

DOBLE EMPUÑADURA DE AGARRE ERGONOMICA, SUAVE Y ANTIDESLIZANTE.

LATERALES PERFORADOS PARA AÑADIR ACCESORIOS

RUEDAS EXTRA FUERTES PARA UN MANEJO SEGURO: RUEDAS GIRATORIAS, 2 CON FRENO

PESTAÑA DE CIERRE INDIVIDUAL POR CAJÓN

MEDIDAS INTERIOR
CAJONES PEQUEÑOS (x5)
 74mm x 705mm x 400mm **25kg**

CAJONES GRANDES (x2)
 151,5mm x 705mm x 400mm **35kg**

980mm x 984mm x 510mm

CON MÓDULOS EVA: **XL** ACCESORIOS Y RECAMBIOS página 80

Módulo 2: 14296 118,00€	15122 74,00€	Módulo 1: 14297 87,00€	15161 62,00€
Módulo 4: 14298 51,50€	15155 59,00€	Módulo 3: 14299 87,00€	15514 9,35€

CARRO DE HERRAMIENTAS 7 CAJONES

53763 890,00€

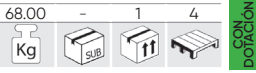

53764 680,00€

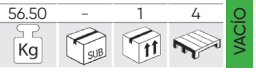

53765 890,00€

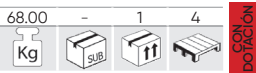

53766 680,00€

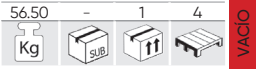

53900 890,00€

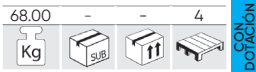

53901 680,00€

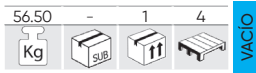

172
PCS

350Kg



ALTA CALIDAD

- RESISTENTE A GRANDES CARGAS
- LIGERO Y FÁCIL DE TRANSPORTAR
- HERRAMIENTAS BIEN ORDENADAS EN MÓDULOS
- CONSTRUCCIÓN ROBUSTA Y DURADERA

LATERALES PERFORADOS PARA PERMITIR AL USUARIO AÑADIR UNA GRAN CANTIDAD DE ACCESORIOS



PESTAÑA DE CIERRE INDIVIDUAL POR CAJÓN



SISTEMA DE CIERRE CON LLAVE

RUEDAS DE 5":
2 FIJAS Y
2 GIRATORIAS, UNA CON FRENO

CON MÓDULOS EVA:
SET DE 4 MÓDULOS EVA
ACABADO EN FIBRA DE CARBONO

53708 325,00€

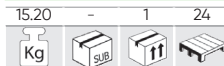

Módulo 1: **14296** 118,00€



ACCESORIOS Y RECAMBIOS

página 80

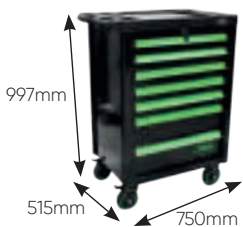

CAJÓN PEQUEÑO (x6)

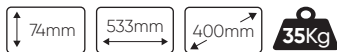

CAJÓN GRANDE (x1)



CAPACIDAD DE CARGA DEL CAJÓN: 40KG.
CAPACIDAD BANDEJA SUPERIOR DE PLÁSTICO: 125KG.

Módulo 2: **14297** 87,00€



Módulo 3: **14298** 51,50€



Módulo 4: **14299** 87,00€



CARRO DE HERRAMIENTAS 7 CAJONES

53661 890,00€

71,50 Kg 1 SUB 1 4

CON DOTACIÓN

53686 890,00€

72,50 Kg 1 SUB 1 4

CON DOTACIÓN

53761 680,00€

52,50 Kg 1 SUB 1 4

VACIO

53762 680,00€

55,50 Kg 1 SUB 1 4

VACIO

53767 890,00€

64,00 Kg 1 SUB 1 4

CON DOTACIÓN

53904 890,00€

72,00 Kg 1 SUB 1 4

CON DOTACIÓN

53768 680,00€

56,00 Kg 1 SUB 1 4

VACIO

54006 680,00€

55,00 Kg 1 SUB 1 4

VACIO



ACCESORIOS Y RECAMBIOS
página 80

INCLUIDO EN EL CARRO:

SET DE 4 MÓDULOS EVA ACABADO EN FIBRA DE CARBONO CON MÓDULOS EVA:

53708 325,00€

15,20 Kg 1 SUB 1 24



	1/2"	x1	5/16
	1/2"	x5	14, 15, 17, 19 y 22 mm
	1/2"	x17	10, 11, 12, 13, 14, 15, 16, 17, 18, 19, 20, 21, 22, 24, 27, 30 y 32 mm
	1/2"	x8	E10, E11, E12, E14, E16, E18, E20 y E24
	1/2"	x2	16, 21
		x2	5", 10"
	1/2"	x1	3/8" 1/2"
	1/4"		1,2
		x18	3,4,5,6 mm
			4,5,5,6,5 mm
			8,10,15,20,25,27,30 mm
	1/4"		2", 3"
		x13	4, 4,5, 5, 5,5, 6, 7, 8, 9, 10, 11, 12, 13 y 14 mm
	1/4"	x8	6, 7, 8, 9, 10, 11, 12, 13 mm
	1/4"	x5	E4, E5, E6, E7 y E8
			7, 8, 10, 12, 14 mm
			8, 10, 12 mm
	8mm	x17	3,4
			3,4
			40, 45, 50, 55, 60 mm
		x3	1,5, 2, 2,5 mm



	6x7 8x9 10x11 12x13 14x15 16x17 18x19 20x22 m
	6 7 8 9 10 11 12 13 14 15 16 17 18 19 20 21 22

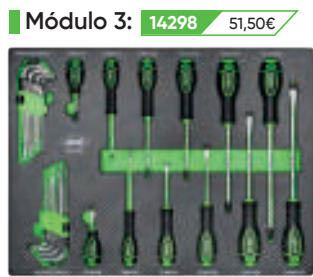

	x6	PH2x38, PH0x75, PH1x100, PH2x100, PH3x150, PH4x200
	x4	SL6x38, SL3x100, SL8x150, SL10x200
	x9	
	x9	



	450g
	35mm
	10"
	8"
	8"
	10"
	7,5"
	8"
	3m



PESTAÑA DE CIERRE INDIVIDUAL POR CAJÓN

2 RUEDAS GIRATORIAS

SISTEMA DE CIERRE CON LLAVE

CAJÓN PEQUEÑO (x5)

	74mm		533mm		400mm		35Kg
--	------	--	-------	--	-------	--	------

CAJÓN GRANDE (x2)

	151,5mm		533mm		400mm		35Kg
--	---------	--	-------	--	-------	--	------

CAPACIDAD DE CARGA DEL CAJÓN: 35KG.
CAPACIDAD TOTAL DE CARGA: 300KG.

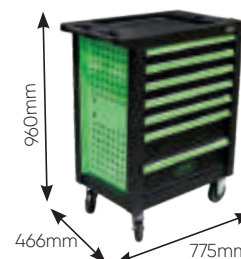

CARRO DE HERRAMIENTAS 7 CAJONES - ESPECIAL CAMIÓN

54240 1.887,00€

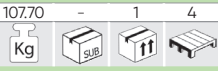

54237 1.887,00€

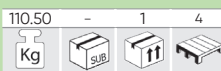

54238 1.887,00€

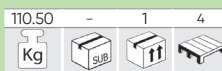

54239 1.887,00€

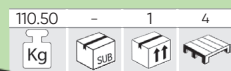

SET DE HERRAMIENTAS PARA REPARACIÓN DE CAMIÓN

54134 1.415,00€

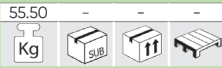

15734 288,50€



	1kg
	24, 27, 30, 32, 36, 41mm
	3/4" 500mm
	3/4" 500mm

15732 293,50€



	10, 13, 17 mm
	10x11, 12x13, 14x17mm
	E10xE12, E14xE18, E20xE24
	8x10, 11x13, 14x15, 16x17, 18x19mm
	27, 30, 32, 36mm
	10, 13, 17, 19mm

15731 214,00€



	6x7, 8x9, 10x11, 12x13, 14x15, 16x17, 18x19, 20x22, 21x23, 24x27, 25x28, 30x32mm
	6, 7, 8, 10, 11, 12, 13, 14, 15, 17, 19, 22, 24mm

15736 488,50€



	1/2" 78mm	13,14,15,16,17,18,19,21,22,24
	3/4" 110mm	22,24,27,30,32,33,36,38,46mm
	1/2" 90mm	51,60mm
	1/2" T40,T45,T50,T60,T70	
	1/2" 78mm	H6,H8,H14,H17
	3/4" 100mm	T80,T90,T100
		1/2"(M)x3/4"(H) 3/4"(M) x1/2"(H)
		1/2", 3/4"
		125mm
	1/2" 40mm	M18

15735 152,00€



	250mm
	6" - 180mm
	7" - 180mm
	90° 300mm
	45° 300mm
	0° 300mm
	220mm
	330mm
	330mm
	330mm

15730 289,00€

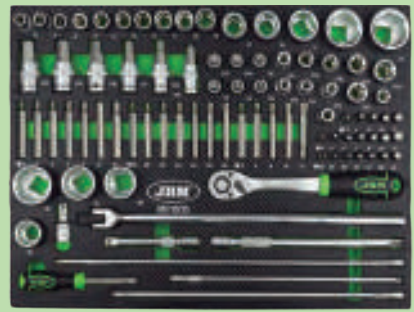

	55mm	H5, H6, H7, H8, H10, H12
	65mm	H14
	70mm	H16, H17, H18, H18, H20
	30mm	H4, H5, H6, H7, H8, H10, H12
	75mm	M5, M6, M8, M10, M12
		T20, T25, T30
		T40, T45, T50, T55
		H4, H5, H6, H7, H8, H10, H12
		M5, M6, M8, M10, M12
		T20, T25, T30
		T40, T45, T50, T55

15733 113,00€



	PH0*75mmL,
	PH1*75mmL,
	PH2*100mmL,
	PH2*38mmL,
	PH3*150mmL,
	PH4*200mmL
	SL3.5*75mmL,
	SL5*75mmL,
	SL6*100mmL,
	SL6*38mmL,
	SL8*150mmL,
	SL9.5*200mmL
	10x11, 12x13, 14x15mm
	10x11, 12x13, 14x15, 16x17, 18x19mm

	1/2" T2	
	1/2" X9	E10, E11, E12, E14, E16, E18, E20, E22, E24
	1/2" X10	10, 11, 12, 13, 14, 15, 16, 17, 18, 19mm
	1/2" X3	50, 125, 250mm
	1/2" X1	430mm
	1/2" X1	10mm
	3/4" X5	21, 24, 27, 34, 36mm
	3/4" X4	24, 30, 32, 36 mm
		1/2x10mm 3/8x10mm
		1/2x10mm 3/8x10mm
	3/8"	10mm
	1/4"	
	1/4"	300, 380, 450mm

CARRO DE HERRAMIENTAS 7 CAJONES - ESPECIAL VEHÍCULO ELÉCTRICO

54236 1.856,00€

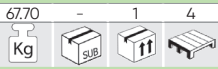

54233 1.856,00€

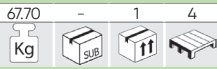

54234 1.856,00€

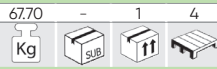

54235 1.856,00€

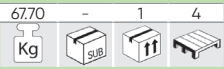

- x1** MÓDULO EVA DE HERRAMIENTAS AISLADAS VDE 26 PIEZAS
- x1** TERMÓMETRO LÁSER -50° a 550°C
- x1** PANTALLA FACIAL AISLANTE PARA TRABAJOS EN TENSIÓN
- x1** CARRO DE HERRAMIENTAS 7 CAJONES -VACÍO
- x1** PÉRTIGA DE SALVAMENTO AISLADA - 45KV
- x1** MEDIDOR DE AISLAMIENTO
- x1** GUANTES AISLANTES PARA TRABAJOS EN TENSIÓN
- x1** ALFOMBRA AISLANTE CLASE 0
- x8** ESLABÓN DE ENCAJE NEGRO
- x4** CADENA DE PLÁSTICO AMARILLA / NEGRA - 5M
- x4** POSTE DE PLÁSTICO PARA CADENA - AMARILLO/NEGRO

Carro especialmente configurado para cubrir todas las necesidades básicas derivadas del mantenimiento y reparación de vehículos híbridos y eléctricos, así como para trabajos en alta tensión.



54093 / 441,00€
MÓDULO EVA DE HERRAMIENTAS AISLADAS VDE 26 PIEZAS

PANTALLA FACIAL AISLANTE PARA TRABAJOS EN TENSIÓN
54132 / 190,00€

TERMÓMETRO LÁSER -50° a 550°C
52162 / 38,00€

x8 ESLABÓN DE ENCAJE NEGRO
53942 / 0,50€

x4 CADENA DE PLÁSTICO AMARILLA / NEGRA - 5M
53941 / 6,05€

x4 POSTE DE PLÁSTICO PARA CADENA - AMARILLO/NEGRO
53940 / 13,20€

CARRO DE HERRAMIENTAS 7 CAJONES VERDE -VACÍO
54006 / 680,00€

PÉRTIGA DE SALVAMENTO AISLADA - 45KV
54241 / 120,00€

GUANTES AISLANTES PARA TRABAJOS EN TENSIÓN T.9
54130 / 58,00€

ALFOMBRA AISLANTE CLASE 0
54129 / 110,00€

MEDIDOR DE AISLAMIENTO
54114 / 248,00€



CARRO DE HERRAMIENTAS 7 CAJONES ESPECIAL KIT DE CALADO

53951 1.794,00€

53952 1.794,00€

53775 1.109,00€

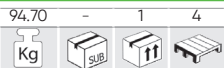

VER
DETALLE

pg.244

SET DE 6 MÓDULOS DE KITS DE CALADO

GASOLINA/PETROL

GASOIL/DIESEL

Módulo 1: **53769** 178,00€

RENAULT / NISSAN / OPEL / VOLVO



Módulo 2: **53770** 198,00€

FORD / SEAT / VOLKSWAGEN / MAZDA / VOLVO



Módulo 3: **53771** 158,00€

FIAT / FORD / CITROËN / PEUGEOT



Módulo 5: **53773** 298,00€

FIAT / ALFA / LANCIA / OPEL / SUZUKI / FORD



Módulo 6: **53774** 190,00€

OPEL / CHEVROLET / SAAB / FIAT / LANCIA / SUZUKI / FORD



Módulo 4: **53772** 229,00€

FORD / VAG / MAZDA / VOLVO

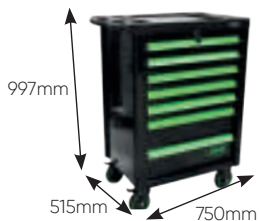

+ INFORMACIÓN DE CADA MÓDULO EN KITS DE CALADO, pág. 238



Escoge el color de carro que quieras y llénalo de

HERRAMIENTAS PARA CHAPISTA

HERRAMIENTAS PARA MANTENIMIENTO

CARRO DE HERRAMIENTAS 7 CAJONES ESPECIAL CHAPISTA

53577 990,00€	53579 990,00€	53580 990,00€	53578 990,00€	256 PCS
74,50 - 1 2 Kg SUB	74,50 - 1 2 Kg SUB	74,50 - 1 2 Kg SUB	74,50 - - - Kg SUB	

Módulo 1:

14059 62,00€ PALANCAS DE NYLON



Módulo 2:

14060 65,00€ MARTILLOS ESPECIAL PARA CHAPA

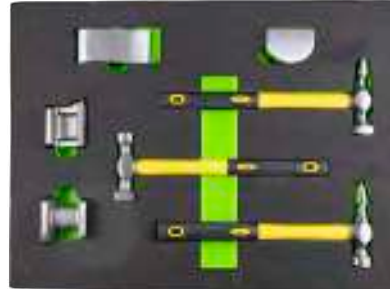

Módulo 3:

14061 93,00€ PINZAS DE PRESIÓN CON MORDAZAS



Módulo 4: VENTOSAS Y HERAMIENTAS PARA SUSTITUCIÓN DE LUNAS

14062 100,00€



Módulo 5:

14063 119,00€ REPARADOR DE ABOLLADURAS



Módulo 6:

14064 39,50€ ÚTILES PARA ABRIR COCHES



CARRO DE HERRAMIENTAS 7 CAJONES ESPECIAL MANTENIMIENTO

53514 990,00€	53556 990,00€	53557 990,00€	256 PCS
74,50 - 1 2 Kg SUB	74,50 - 1 2 Kg SUB	74,50 - 1 2 Kg SUB	

53469 613,00€

SET DE 5 MÓDULOS PARA CARRO DE CAMBIO DE ACEITE:

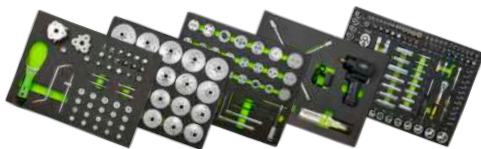

Módulo 1:

14141 105,00€ EXTRACTORES DE FILTROS DE ACEITE



Módulo 2:

14142 109,00€ REPOSICIONADOR DE FRENOS

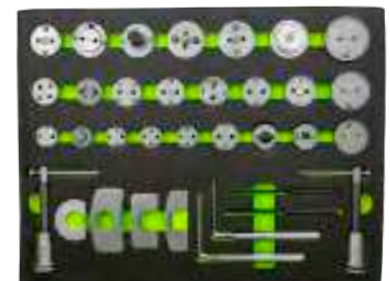

Módulo 3: TAPONES CÁRTER Y EXTRACTORES DE FILTRO DE ACEITE AJUSTABLES

14143 124,00€



Módulo 4:

14144 304,00€ PISTOLA Y VASOS DE IMPACTO



Módulo 5:

14296 118,00€ 108 PIEZAS CON VASOS HEX.



CARRO DE 7 CAJONES CON GUÍA TELESCÓPICA CON Y SIN DOTACIÓN

52393 1.180,00€

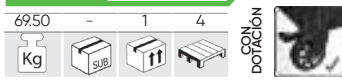

52172 780,00€

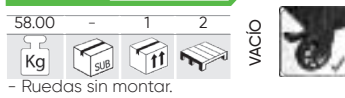

- Espesor de metal:
Cajón: 0,8mm
Cuadro: 1mm

179
PCS



CON SUPERFICIE DE GOMA ANTIDESLIZANTE

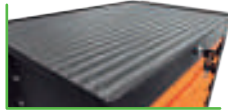

SISTEMA DE CIERRE CON LLAVE



RUEDAS CON FRENOS



125x50mm

1010mm



MEDIDAS INTERIOR

CAJONES PEQUEÑOS (x5)



CAJONES GRANDES (x2)



CON MÓDULOS EVA:

53708 325,00€

Módulo 1: **14296** 118,00€

Módulo 2: **14297** 87,00€

Módulo 3: **14298** 51,50€

Módulo 4: **14299** 87,00€

SET DE 4 MÓDULOS EVA ACABADO EN FIBRA DE CARBONO

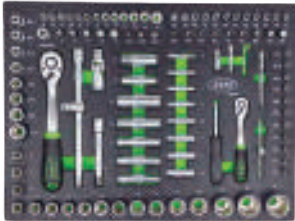

CARRO DE HERRAMIENTAS 9 CAJONES

53867 1.095,00€



ACCESORIOS Y RECAMBIOS página 80

CON SEPARADORES



ORGANIZACIÓN LIBRE

18
PCS

INCLUIDAS EN EL CARRO

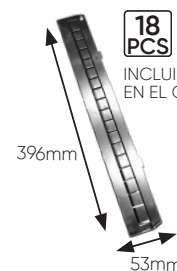

21
PCS

INCLUIDAS EN EL CARRO

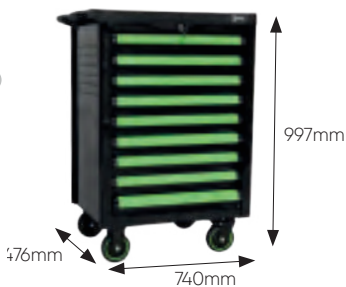

MEDIDAS CAJÓN



TAMBIÉN TE PUEDE INTERESAR...

REF.	mm	Kg	11	€
15070	67x53mm	0,05	200	0,50€
15071	103x53mm	0,05	200	0,60€
15072	138x53mm	0,05	200	0,70€
15074	210x53mm	0,10	200	1,00€
15075	280x53mm	0,10	200	1,20€

15076 3,50€

0,30 Kg 50

15073 1,00€

0,05 Kg 200

CARRO DE HERRAMIENTAS CON 1 CAJÓN

53866

424,00€

35.00	-	1	4
Kg	Sub	ff	



350Kg

ACCESORIOS Y RECAMBIOS

página 80



ARMARIOS

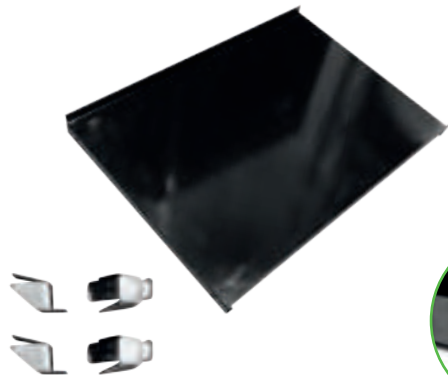

BANDEJA SEPARADOR AJUSTABLE

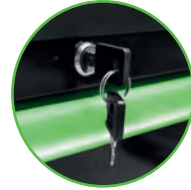

SISTEMA DE CIERRE CON LLAVE



SUPERFICIE DE GOMA ANTIDESLIZANTE



MEDIDAS CAJÓN

75mm	533mm	400mm	35Kg
------	-------	-------	------



MÓDULOS DE HERRAMIENTAS

JUEGO DE VASOS PARA TAPONES CÁRTER

15084

68,00€

1.70	-	-	-
Kg	Sub	ff	

MÓDULO ACABADO EN FIBRA DE CARBONO



30mm	380mm	175mm
------	-------	-------

TE PUEDE INTERESAR...

15018	1.45	10
46,00€	Kg	ff

MÓDULO VACIO PARA 15018

15083 8,50€

0.05	-	20	480
Kg	Sub	ff	

CONTIENE

	x2	5/16", 3/8"
	x7	7, 8, 10, 11, 12, 13, 14mm
	x1	10mm
	x1	10mm
	x7	8, 9, 10, 12, 13, 14, 17mm
	x1	T45
	x1	M16
	x1	200mm
	x1	150mm



También apto para recogedores de aceite 53873 y 53874.

IVA no incluido

MÓDULOS EVA 175x30x380mm

MÓDULOS DE HERRAMIENTAS

15734 288,50€ pg.70 18,00 Kg 2 48	15732 293,50€ pg.70 12,00 Kg 2 48	15731 214,00€ pg.70 12,00 Kg 2 48	15735 152,00€ pg.70 10,00 Kg 2 48
15730 289,00€ pg.70 20,00 Kg 2 48	15736 488,50€ pg.70 29,00 Kg 2 40	15733 113,00€ pg.70 7,00 Kg 2 48	

SET DE 4 MÓDULOS EVA ACABADO EN FIBRA DE CARBONO

53708 325,00€

30mm x 525mm x 380mm

15,20 Kg 1 24

14296 118,00€

6,05 Kg 4 80

14297 87,00€

3,30 Kg 4 96

14296

	1/2" x17	10, 11, 12, 13, 14, 15, 16, 17, 18, 19, 20, 21, 22, 24, 27, 30, 32mm
	1/4" x13	4, 4.5, 5, 5.5, 6, 7, 8, 9, 10, 11, 12, 13, 14mm
	1/2" x5	14, 15, 17, 19, 22mm
	1/4" x8	6, 7, 8, 9, 10, 11, 12, 13mm
	1/2" x8	E10, E11, E12, E14, E16, E18, E20, E24
	1/4" x5	E4, E5, E6, E7, E8
	7Z x2	1/2" - 1/4"
	1/2" x2	125, 250mm
	1/4" x2	50, 100mm
	x2	adaptador 3/8" (H) - 1/2" (M)
	1/2" x1	
	1/2" x2	16, 21mm
	1/2" x1	8mm
	x3	1.5, 2, 2.5mm
	x1	1/4"
	x1	1/4"
	x2	PH3, PH4
	x2	PZ3, PZ4
	8mm x5	7, 8, 10, 12, 14mm
	x3	SL8, SL10, SL12
	x5	T40, T45, T50, T55, T60
	x2	PH1, PH2
	x2	PZ1, PZ2
	1/4" x4	3, 4, 5, 6mm
	x3	SL4, SL5.5, SL6.5
	x8	T8, T10, T15, T20, T25, T27, T30

14298 51,50€

2,10 Kg 4 96

14299 87,00€

3,25 Kg 4 96

14298

	PH0x75, PH1 x 100, PH2 x 100, PH3 x 150, PH4 x 200
	6, 7, 8, 10, 11, 12, 13, 14, 15, 17, 19, 22mm
	2x38mm
	6x38mm
	1.5, 2, 2.5, 3, 4, 5, 6, 8, 10mm
	TX10, 15, 20, 25, 27, 30, 40, 45, 50

14297

	6x7, 8x9, 10x11, 12x13, 14x15, 16x17, 18x19, 20x22mm
	6, 7, 8, 10, 11, 12, 13, 14, 15, 17, 19, 22mm

14299

	x1	8"
	x1	10"
	10"	7.5"
	8"	3m
	8"	

MÓDULOS EVA CON ACABADO EN FIBRA DE CARBONO

210x50x120mm



15122 74,00€

1.70 Kg 10 200

8, 9, 10, 11, 12, 13, 14, 15, 16, 17, 18, 19mm



15155 59,00€

2.45 Kg 10 180

8, 10, 11, 12, 13, 14, 15, 16, 17, 18, 19mm



15156 70,00€

2.05 Kg 10 180

21x23, 24x27, 25x28, 30x32 mm



15157 42,00€

0.95 Kg 10 300

6x8, 10x12, 13c14, 15x17, 19x21, 22x24 mm



15158 59,00€

1.30 Kg 10 240

8, 10, 11, 13, 14, 17, 19 mm



15159 44,00€

0.75 Kg 10 300

8x10, 11x13, 14x15, 17x19, 20x22 mm



53943 21,50€

0.80 Kg 10 240

PH4x200, PH3x150, PH2x100, PH2x38, PH1x80, PH0x120, PH1x100



53944 19,50€

0.80 Kg 10 240

SL9x200, SL4x125, SL5x100, SL5x80, SL6x38, SL6x100, SL8x150 mm

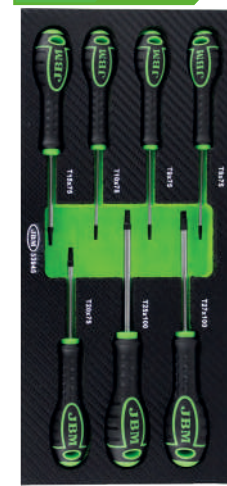

53945 18,90€

0.60 Kg 10 240

T8x75, T9x75, T10x75, T15x75, T20x75, T25x100, T27x100



54158 38,00€

1.70 Kg 8 200

	3/8"	x1	10mm
	1/2"	x1	10mm
	30mm	x7	4, 5, 6, 7, 8, 10, 12mm
	75mm	x7	4, 5, 6, 7, 8, 10, 12mm
	30mm	x8	T20, T25, T30, T40, T45, T50, T55, T60
	75mm	x8	T20, T25, T30, T40, T45, T50, T55, T60
	30mm	x5	M5, M6, M8, M10, M12
	75mm	x5	M5, M6, M8, M10, M12



15160 42,00€

0.80 Kg 10 300

8x9, 10x11, 12x13, 14x15, 16x17, 18x19 mm



15161 62,00€

2.10 Kg 10 180

27, 29, 30, 32 mm



15316 58,00€

0.85 Kg 10 260

8, 9, 10, 11, 12, 13, 14, 15, 16, 17, 18, 19mm



15454 35,40€

1.10 Kg 10 300

8"



15541 27,60€

0.95 Kg 10 220

IVA no incluido

210x50x120mm

15514 9,35€



0.05 Kg 10 360

15162 30,20€



0.65 Kg 10 240

Medidas: SL 6.5x150mm Comprobador de tensión, PH 0x75mm, SL 3x75mm, PH 1x80mm, SL 4x100mm, PH 2x100mm, SL 5.5x125mm, SL 0.5 x 3.0 mm

15706 31,00€



0.55 Kg 10 240

15737 45,00€



1.70 Kg 10 200

15315 28,20€



1.05 Kg 10 260

MÓDULOS DE HERRAMIENTAS

175x50x460mm

51864 64,00€

1.87 Kg 10 210



10x11mm (290mmL), 12x14mm (330mmL), 13x15mm (368mmL), 16x18mm (407mmL), 17x19mm (407mmL), 22x24mm (430mmL)

52912 91,00€

1.62 Kg 10 210

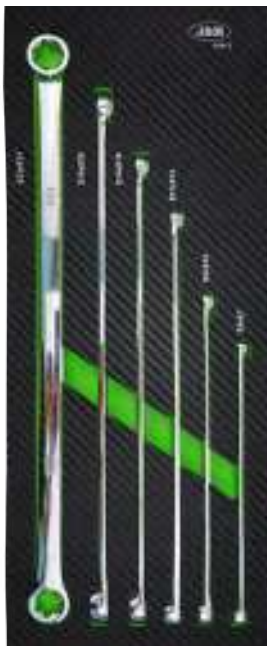

E6xE7 (200mmL), E8xE10 (235mmL), E11xE12 (290mmL), E14xE16 (370mmL), E18xE20 (410mmL), E22xE24 (420mmL)

54066 83,00€

2.00 Kg 5 175



8mm (23,5mmL), 10mm (29,3mmL), 12mm (32,8mmL), 13mm (34,9mmL), 14mm (36,7mmL), 17mm (41mmL), 19mm (42mmL)



520x50x390mm

15681 134,00€

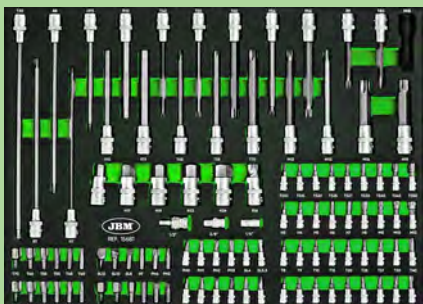

	H3, H4, H5, H6, H7, H8
	M8, M10, M12
	PH0, PH1, PH2, PH3
	PZ0, PZ1, PZ2, PZ3
	1/4" SL4, SL5.5, SL6.5, SL7
	T8, T9, T10, T15, T20, T25, T27, T30, T40
	T8, T9, T10, T15, T20, T25, T27, T30, T40
	TS10, TS15, TS20, TS25, TS27, TS30, TS40, TS45, TS50
	1/2" H7 (230mmL), H10, H11, H13 (140mmL), H14, H17, H19, H22, H24 (55mmL)
	M9 (100mmL), M10, M12, M14 (140mmL), M16 (53mmL), M16 (100mmL)
	R7, R8 (240mmL), R9 (100mmL), R10 (140mmL)
	T30 (300mmL), T40, T45, T50, T55, T60, T70 (140mmL), T80 (100mmL)
	HT5 (160mmL)

	1/2"	8mm
	3/8"	8mm
	1/4"	6mm
	1/2"	M18
		7, 8, 10, 12, 14mm
		PH3, PH4
		PZ3, PZ4
		SL8, SL10, SL12
	8mm	T40, T45, T50, T55, T60, T70
		T40, T45, T50, T55, T60, T70

15799 28,30€



1.35 - 10 200
Kg 5.9 11 15

16111 19,20€



0.61 - 10 360
Kg 5.9 11 15

11996 48,00€

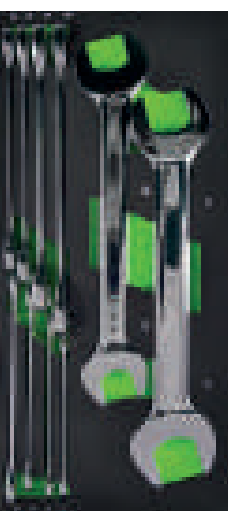

2.10 - 10 300
Kg 5.9 11 15

6x7mm - 20x22mm +
24x27mm + 30x32mm

11997 39,00€

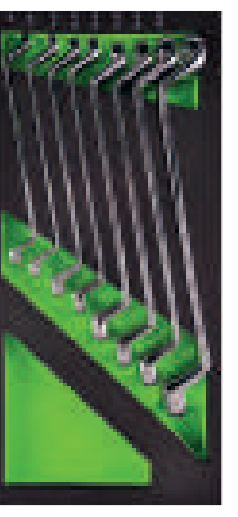

1.92 - 10 360
Kg 5.9 11 15

6x7mm - 18x19mm +
20x22mm

11998 49,00€

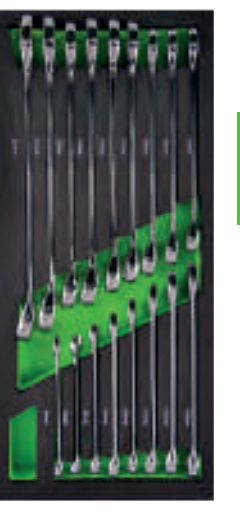

1.96 - 10 300
Kg 5.9 11 15

6x7mm - 18x19mm -
20x22mm



11994 33,00€



1/4"
0.68 - 10 233
Kg 5.9 11 15

14114 19,30€



0.93 - 10 360
Kg 5.9 11 15

13923 7,45€

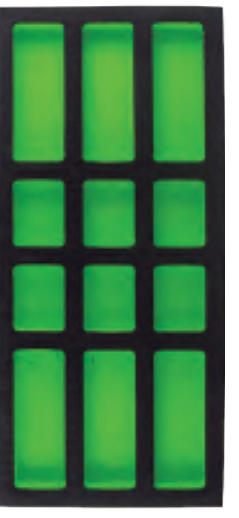

0.05 - 30 1299
Kg 5.9 11 15

13667 17,60€



0.83 - 10 360
Kg 5.9 11 15

13668 18,70€



0.61 - 10 300
Kg 5.9 11 15

MÓDULOS PLÁSTICO

10731 17,60€



0.68 - 10 233
Kg 5.9 11 15

10732 18,70€



0.70 - 10 220
Kg 5.9 11 15

10733 17,50€



0.69 - 10 220
Kg 5.9 11 15

10735 20,30€



0.98 - 10 300
Kg 5.9 11 15

53671 41,00€



210x50x120mm
72
1/4" - 85 mm
1/2" - 135 mm
3/8" - 102 mm
0.85 10 470
Kg 11 15

53620 88,00€

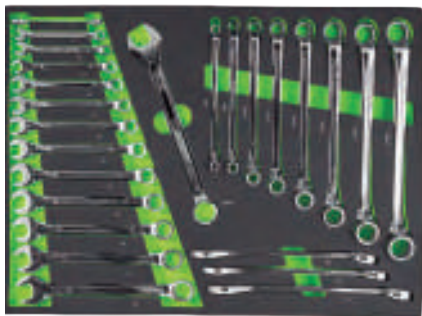

3.52 4 112
Kg

6x78x910x1112x13,
14x15,16x17,18x19,20
x22mm
6,78,9,10,11,12,13,
14,15,16,17,18,19, 20,
21,22mm

54093 441,00€



3.52 4 112
Kg

51447 16,00€



0.34 5 20 960
Kg

50mm, 75mm, 100mm,
152mm, 227mm

53979 34,60€

340x50x390mm



1.00 180
Kg

H2x100, H2.5x100, H3x100,
H4x150, H5x150, H6x200,
H8x200, H10x200

53980 34,60€

340x50x390mm



1.00 10 180
Kg

T10X75, T15X75, T20X100,
T25X100, T30X150,
T40X150, T45X200,
T50X200mm

51805 17,00€



0.33 4 20 640
Kg

50mm, 75mm, 100mm,
152mm, 227mm

51448 52,00€

130x50x540mm



2.38 - 5 270
Kg

50mm, 125mm, 250mm, 380mm, 510mm

ACCESORIOS

COMPATIBILIDAD

53764/53765/53766/53767/53768/53769/53770/
53900/53901/53902/53912/53913

PORTA SPRAYS Y PORTA ACCESORIOS

15313 14,00€

0.60 1 340
Kg



PORTA SPRAYS

14354 14,00€

0.60 1 184
Kg



PORTABOBINA DE PAPEL

15068 15,20€

0.65 25 500
Kg



PORTA ARCHIVADOR

15069 32,80€

1.65 1 80
Kg



COMPATIBILIDAD

53686/53762/53661 53761/53767/53768/53904/54006

PORTABOBINA DE PAPEL

16161 17,50€

0.65 25 -
Kg



PORTA ARCHIVADOR

16162 35,10€

1.65 1 -
Kg



PORTA SPRAYS Y PORTA ACCESORIOS

16163 10,20€

0.60 1 -
Kg

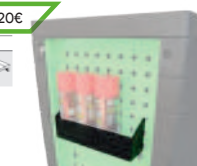

CUBO DE BASURA COLGABLE

16188 39,60€

2.00 25 -
Kg



RECAMBIOS PARA CARROS REF. 53661, 53686, 53763, 53764, 53765, 53766, 53867, 53868, 53869, 53870, 53900, 53901, 53904

REF.	DESCRIPCIÓN	Kg	Paq	U	€	COMPATIBILIDAD
14578	Guía cajón grande	1,05	1	25	12,50€	53661, 53686, 53904
14580	Tapa superior	2,60	3	39	41,00€	53661, 53686, 53904
14783	Protector lateral derecho	0,25	1	50	5,50€	53661, 53686, 53904
15023	Rueda fija	0,65	1	10	12,50€	53765, 53766, 53870
15024	Rueda giratoria	0,95	1	8	15,00€	53765, 53766, 53870
15025	Rueda fija	0,65	1	10	12,50€	53900, 53901
15026	Rueda giratoria	0,95	1	8	15,00€	53900, 53901
15030	Tirador de cajón	0,30	1	50	8,00€	53765, 53766
15033	Tirador de cajón estrecho	0,30	1	50	6,00€	53868
15034	Tapa superior	-	-	-	57,00€	53868
15035	Tirador de cajón	0,36	1	20	8,50€	53869
15036	Tirador de cajón	0,36	1	20	8,50€	53870
15037	Tirador de cajón	-	-	-	8,00€	53900, 53901
15038	Tapa superior	-	-	-	34,50€	53869, 53870
15040	Rueda fija	0,66	1	10	12,50€	53904
15041	Rueda giratoria	0,98	1	8	15,00€	53904
15042	Tirador de cajón	0,10	1	-	7,50€	53904
15050	Tirador de cajón	0,10	1	50	9,50€	53661, 53686
15058	Protector lateral	-	-	-	7,50€	53868
15065	Protector lateral	0,55	1	12	6,50€	53869, 53870



14580, 15034,
15038



14578



15030, 15035,
15036, 15037,
15042, 15050



15033



14783



15058, 15065



15023, 15025,
15040



15024, 15026,
15041

CARRO CON 3 BANDEJAS

51576 125,00€



CARRO CON 3 BANDEJAS MAXI

52373 252,00€

150Kg

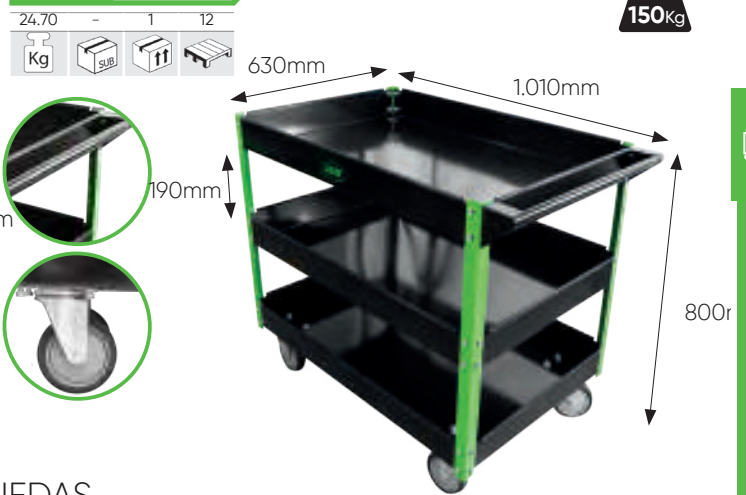

ARMARIO DE TRABAJO MULTIMEDIA CON RUEDAS

51456 550,00€

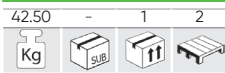

- Ruedas sin montar.

SET DE 4 RUEDAS PARA ARMARIO REF. 51456

Ø12cm
2 Ruedas con freno + 2 simples

11313 54,00€

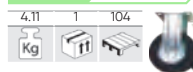

PANEL PARA HERRAMIENTAS

52419 80,00€



1.000 x 600mm

52420 108,00€



1.500 x 600mm

52421 172,00€

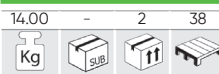

2.000 x 600mm



ENGANCHE CUADRADO

GANCHOS

ESPECIAL DESTORNILLADORES

51657 5,85€

PARA REF.:
52419, 52420, 52421

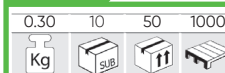

ESPECIAL LLAVES

51653 5,10€

PARA REF.:
52419, 52420, 52421

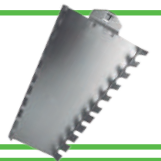

PARA REF. 52419, 52420, 52421

95mm **GANCHO PICO CERRADO**

51654 4,80€

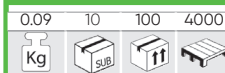

31mm **GANCHO 2 PICOS CORTOS**

51655 4,10€

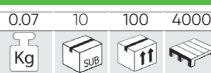

200mm **GANCHO DOS PICOS EXTRA LARGOS**

52634 5,25€

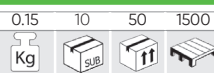

200mm **GANCHO PICO CERRADO EXTRA LARGO**

52635 4,80€

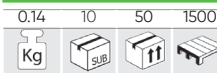

92mm **GANCHO 2 PICOS LARGOS**

51658 4,50€

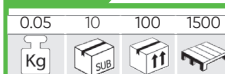

91mm **GANCHO PICO LARGO**

51656 3,65€

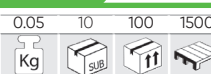

95mm **GANCHO 2 PICOS LARGOS**

51422 2,97€



PARA REF. 51035, 53661, 53686, 53761, 53762, 53767, 53768, 53904

GANCHO 2 PICOS LARGOS

95mm

51422 2,97€



PARA REF. 51428, 51430, 52705, 52706, 52707, 52708, 52709

GANCHO 1 PICO LARGO

51419 2,79€



GANCHO 1 PICO CORTO FONDO

51975 2,27€



GANCHO 2 PICOS LARGOS

51976 1,63€



MESA DE TRABAJO CON PANEL FRONTAL

51035 799,00€

MEDIDAS CAJÓN



600Kg

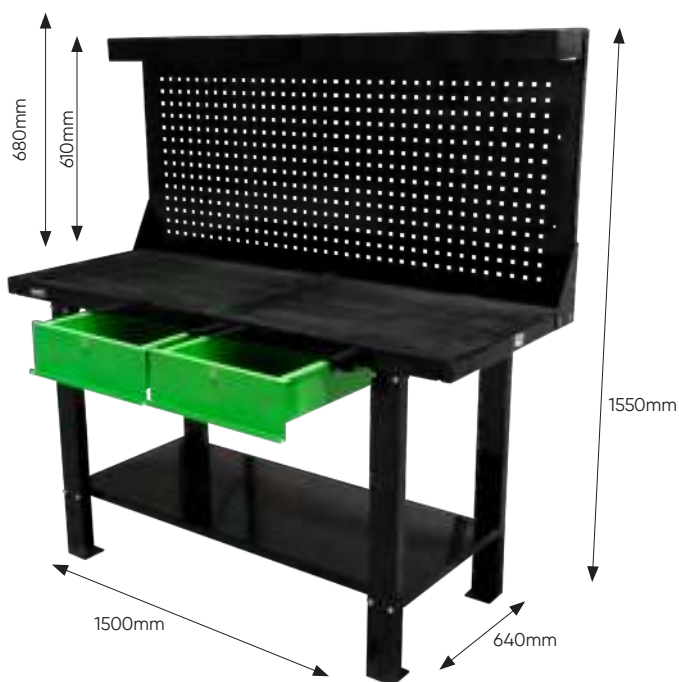

SET DE 2 ALFOMBRAS DE GOMA PARA MESA DE TRABAJO REF. 51737

15145 20,45€



MESA DE TRABAJO CON 3 CAJONES

51738 850,00€

MEDIDAS CAJÓN

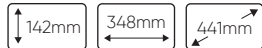

1T

50Kg

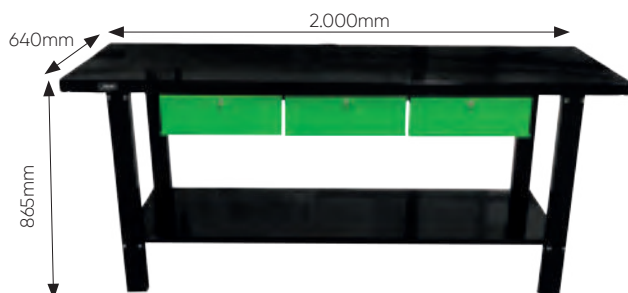

ALFOMBRA DE GOMA

15144 30,00€

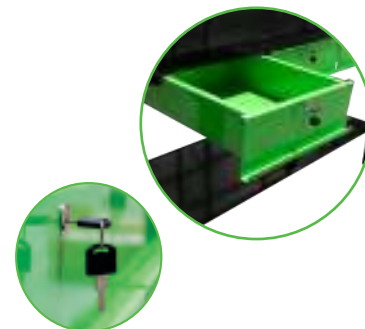

MESA DE TRABAJO CON 2 CAJONES

51737 699,00€

MEDIDAS CAJÓN

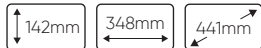

800Kg

MESA DE TRABAJO CON 1 CAJÓN

53674 447,00€

MEDIDAS CAJÓN

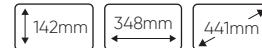

800Kg

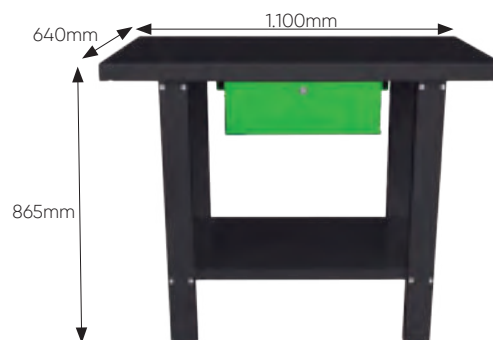
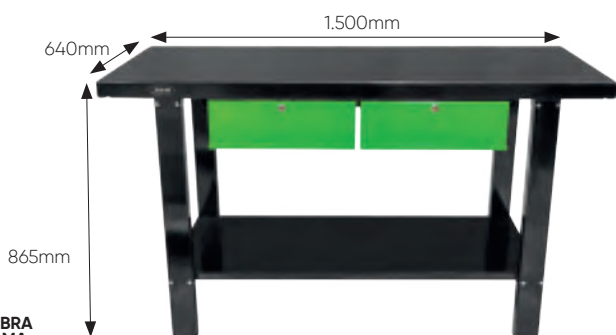

ALFOMBRA DE GOMA

15145 20,45€



ALFOMBRA DE GOMA

15146 16,20€



CARRO MODULAR

53672

440,00€

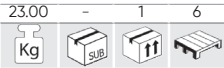

90
PCS



3 COMPARTIMENTOS
DESMONTABLES Y
SEPARABLES

PUEDEN SER UTILIZADOS
INDIVIDUALMENTE O
CONJUNTAMENTE



ASA SUPERIOR EN CADA MÓDULO PARA FACILITAR
EL TRANSPORTE INDIVIDUAL



BLOQUEABLE CON CANDADO
(NO INCLUIDO)

3 MÓDULOS INDEPENDIENTES
EQUIPADOS CON:



	1/2" x11	8,10,11,12,13,14,16,17,19,21,22mm
	1/4" x13	4,4.5,5.5,5.5,6,7.8,9,10,11,12,13,14mm
	1/2" x2	125,300mm
	1/4" x2	50,100mm

	1/4" x1	
	1/4" x1	
	1/4" x1	
	1/2" x1	
	1/4" x1	
	x8	1,5x8mm
	x1	3m
	1/4" x32	



	x1	180mm
	x1	160mm
	x2	160mm, 180mm
	x2	PH2x125, PH1x100mm
	x2	6x150mm, 5x100mm



	x9	8,9,10,11,12,13,14,17,19mm
	x1	250mm
	x1	300g
	x1	250mm
	x1	200mm



Bandeja superior extraíble

Contenedor para
herramientas
más grandes

3 MÓDULOS INDEPENDIENTES
EQUIPADOS CON:

1 CAJA DE HERRAMIENTAS EN MÓDULOS
EVA + BANDEJA SUPERIOR EXTRAÍBLE

2 2 CAJONES CON HERRAMIENTAS
EN MÓDULOS EVA

3 ASA DE TRANSPORTE PLEGABLE
RUEDAS RESISTENTES

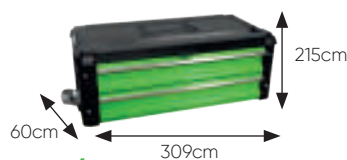

IVA no incluido

JBM / www.jbmcamp.com

CAJA DE HERRAMIENTAS DE HIERRO 64 PCS

53565 258,00€

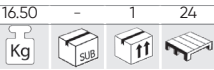

CrV 64 PCS

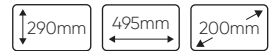

CINCADO



INCLUYE:

CONTIENE

	1/2" x18	10, 11, 12, 13, 14, 15, 16, 17, 18, 19, 20, 21, 22, 23, 24, 27, 30, 32mm		1/2" x1	255mm		+	x3	PH1x100mm, PH2x150mm, PH3x200mm
	7Z x1	1/2"		1/2" x1	21mm		-	x3	SL5x100mm, SL6x150mm, SL8x200mm
	x1	1/2"		x1	457mm				
	x1	1/2"		x18	6, 7, 8, 9, 10, 11, 12, 13, 14, 15, 16, 17, 18, 19, 20, 21, 22, 24mm				
	1/2" x3	76, 127, 254mm		x9	15, 2, 2.5, 3, 4, 5, 6, 8, 10mm				



CAJA PARA HERRAMIENTAS CON 5 COMPARTIMENTOS

51574 52,00€

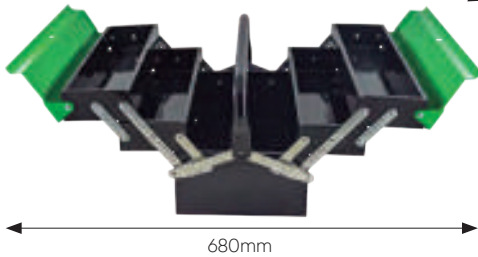

CAJA PARA HERRAMIENTAS XL

53222 57,00€



XL

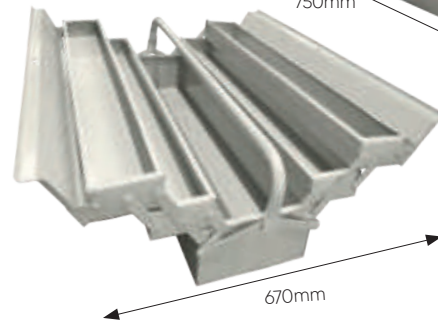
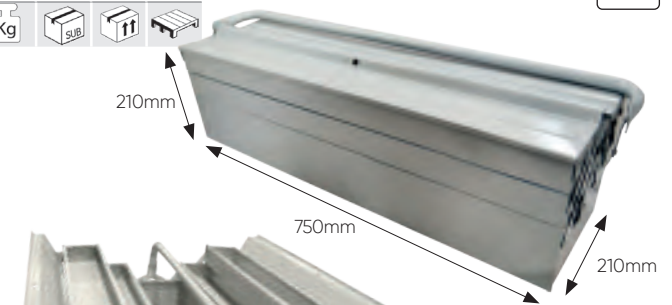

CAJA PARA HERRAMIENTAS CON 3 CAJONES FRONTALES + COMPARTIMENTO SUPERIOR

51600 109,00€



MEDIDAS CAJÓN

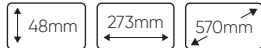

CON ASA

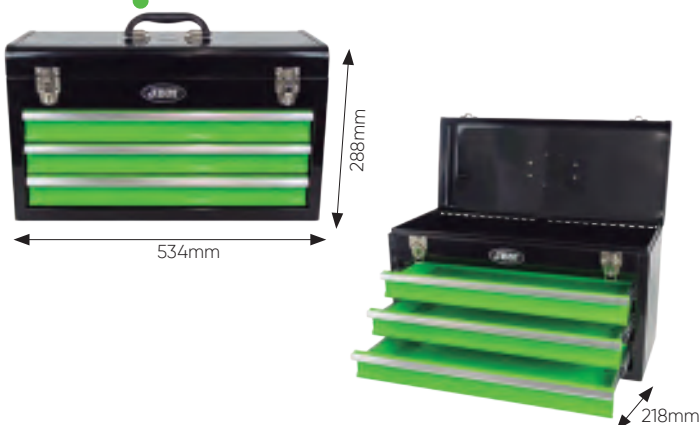

CAJA PARA HERRAMIENTAS CON 6 CAJONES + COMPARTIMENTO SUPERIOR

51575 317,00€



- Cajones grandes: 570mm ancho
- Cajones pequeños: 180mm ancho

SIN ASA



ASIENTO NIVELABLE

50843 79,00€

5,61 - 1 48
Kg SUB

520mm

↑520mm
↓390mm



TABURETE DE ACERO

50844 65,00€

3,50 - 1 60
Kg SUB

100 KG



CAMILLA PLÁSTICA

52148 82,00€

6,00 - 1 20
Kg SUB

- Plástico alta densidad.
- Ruedas reforzadas de goma.
- Muy resistente.

150KG



RUEDA PARA CAMILLA PLÁSTICO REF.52148

11971 3,10€

0,20 50 -
Kg SUB

CAMILLA PLEGABLE METÁLICA

50808 77,00€

5,63 - 1 28
Kg SUB

150KG



CAMILLA PLEGABLE CONVERTIBLE

53211 75,00€

5,40 - 1 38
Kg SUB

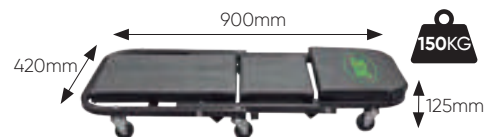

52542 109,00€

12,70 - 1 19
Kg SUB

DE ACERO Y ASIENTOS DE PVC



6 RUEDAS



135KG

115KG

TORNILLO DE BANCO BASE ROTATIVA CON APERTURA RAPIDA

52871 248,00€

24,50 - 1 28



APERTURA INMEDIATA
MEDIANTE PALANCA +
BASE ROTATIVA



TORNILLO DE BANCO BASE ROTATIVA

53031 59,00€

5,70 - 1 128

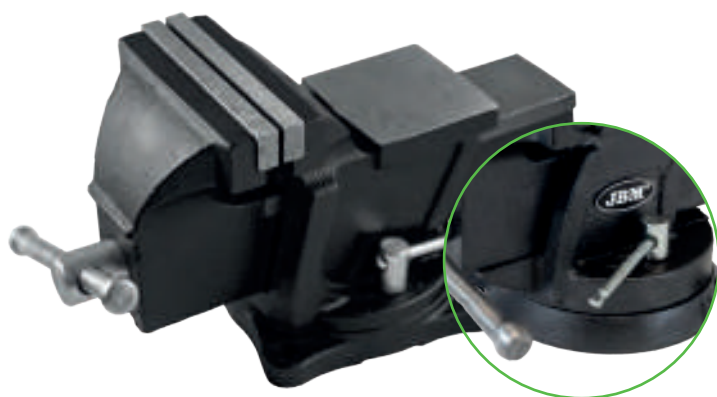

53032 126,00€

13,71 - 1 60



TORNILLO DE BANCO

52869 52,00€

4,15 - 4 192



52870 100,00€

12,15 - 1 72

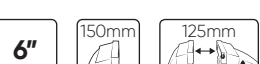

YUNQUES DE ACERO

52308 440,00€

47,00 - 1 24



52309 941,00€

100,00 - 1 8



ACERO



HERRAMIENTAS ELÉCTRICAS A BATERÍA

- 88 LLAVES DE IMPACTO
- 91 CARRACA / ATORNILLADOR
- 92 TALADRO DE IMPACTO
- 94 PULIDORA
- 95 SIERRAS
- 98 MULTIHERRAMIENTA OSCILANTE
- 99 PISTOLAS
- 101 ASPIRADOR/COMPRESOR
- 102 ILUMINACIÓN LED
- 103 JARDINERÍA
- 107 ALMACENAMIENTO
- 108 BATERÍAS / CARGADORES
- 109 ACCESORIOS / CONSUMIBLES

Herramientas eléctricas sin cable, para un uso más cómodo y sin límites

Con motor **BRUSHLESS (sin escobillas)**:
mayor eficiencia, mayor vida útil,
más velocidad y menos ruido.

CE RoHS 

LLAVE DE IMPACTO A BATERÍA 1/2"

1000Nm

60018 306,00€

3.10 - 4 120
Kg SUB if

Batería no incluida.

Esta herramienta ha sido diseñada para proporcionar una alta potencia de torsión con un mínimo esfuerzo por parte de usuario.



BRUSHLESS MOTOR **20V** **1000 Nm** **1/2"** **0-2300IPM**

① 0-900 RPM ② 0-1600 RPM ③ 0-1900 RPM **LED**

EJE DE SALIDA
14675 17,00€

INTERRUPTOR
14677 9,00€

CAPARAZÓN DEL CABEZAL
14679 9,50€

PLACA BASE + ESTATOR
14648 106,00€

CONJUNTO BLOQUE DE IMPACTO
14676 36,50€

PLACA BASE
14678 86,00€

ROTOR
14769 37,75€

5 MARCHAS DISTINTAS
3 DE APRIETE Y 2 DE AFLOJAR

¿Quieres ver cómo funciona?



Empuñadura ergonómica.
Selector de la dirección de rotación.
Luz de trabajo LED.
Gancho para cinturón.



NUEVO MODELO MEJORADO



LLAVE DE IMPACTO 1/2" A BATERIA

1200Nm

60044 478,00€

3.20	-	5	144
Kg	Sub	ff	

Batería no incluida.

Esta herramienta ha sido diseñada para proporcionar una alta potencia de torsión con un mínimo esfuerzo por parte de usuario.

BRUSHLESS MOTOR

20V **1200 Nm** **1/2"**

0-1000 RPM 0-1350 RPM 0-1600 RPM

0-1000IPM 0-1600IPM 0-2000IPM

YUNQUE

16151 50,00€

CARCASA FRONTAL

16152 25,10€

BLOQUE DE IMPACTO

16153 81,00€

ROTOR

16154 34,10€

ESTATOR

16155 34,10€

INTERRUPTOR

16156 12,60€

PLACA BASE

16157 59,00€

5 MARCHAS DISTINTAS
3 DE APRIETE Y 2 DE AFLOJAR



PISTOLA DE IMPACTO BRUSHLESS A BATERIA 1/2" CON MALETIN

60044C 652,00€

3.20	-	4	-
Kg	Sub	ff	

INCLUYE

CARGADOR 20V - 4A

60016 49,00€

0.80	-	5	210
Kg	Sub	ff	

BATERÍA LI-ION 4.0Ah

60013 80,00€

0.75	-	5	700
Kg	Sub	ff	



Utilízalas con las baterías JBM: una única batería apta para todas las herramientas

BATERÍAS LI-ION

2.0Ah



60012

4.0Ah



60013

6.0Ah



60015

CARGADORES



4A
60016



CARGA RÁPIDA 6A
60017



LLAVE DE IMPACTO 3/4" A BATERIA

1550Nm

60034 320,00€

3,20	-	4	144

Batería no incluida.

Esta herramienta ha sido diseñada para proporcionar una alta potencia de torsión con un mínimo esfuerzo por parte de usuario.

BRUSHLESS MOTOR

20V **1550 Nm** **3/4"**

① 0-900 RPM ② 0-1600 RPM ③ 0-1900 RPM

EJE DE SALIDA	INTERRUPTOR	CAPARAZÓN DEL CABEZAL
14675 17,00€	14677 9,00€	14679 9,50€
CONJUNTO BLOQUE DE IMPACTO	PLACA BASE	ROTOR
14676 36,50€	14678 86,00€	14769 37,75€
		PLACA BASE + ESTATOR
		14648 106,00€

5 MARCHAS DISTINTAS
3 DE APRIETE Y 2 DE AFLOJAR



¿Quieres ver cómo funciona?



Empuñadura ergonómica.
Selector de la dirección de rotación.
Gatillo.
Luz de trabajo LED.
Gancho para cinturón.



ATORNILLADOR

60005 132,00€

1.40 - 4 180



Batería no incluida.

Esta herramienta ha sido diseñada para **atornillar y apretar tornillos y tuercas de forma rápida**, especialmente al trabajar con **tornillos pasadores largos** y en **materiales robustos**.

Viene equipada con una **luz de trabajo LED** para mejorar la precisión durante su uso, un **porta puntas hexagonal de 1/4"** que permite una inserción y extracción rápida de las puntas.

Luz led incorporada.
Porta-puntas: hexagonal de 1/4".
Interruptor de velocidad variable.
Empuñadura ergonómica.
Engranajes metálicos.
Gancho de transporte.



BRUSHLESS MOTOR 20V 200 Nm LED 0-2800 RPM 1/4"



BLOQUE DE IMPACTO

14637 15,50€

PLACA BASE

14642 83,00€

EJE EN T

14638 7,00€

PLACA BASE + ESTATOR

14765 97,00€

INTERRUPTOR

14640 8,00€

CABEZAL

15254 12,50€

ROTOR

14641 18,50€

CONSUMIBLES: Estuches de puntas

53857



53858



página 111

Utilízalas con las baterías JBM: una única batería apta para todas las herramientas

BATERÍAS LI-ION

2.0Ah



60012

4.0Ah



60013

6.0Ah



60015

CARGADORES



4A

60016



CARGA RÁPIDA

6A

60017

CARRACA DE 1/2" A BATERÍA

60024 190,00€

1.90 - 5 150



ESTA REFERENCIA INCLUYE
X1 BATERÍA Y X1 CARGADOR

Esta herramienta está diseñada para **apretar y aflojar tornillos** en **espacios reducidos**.



12V

80 Nm

1/2"

0-175 RPM

LED



2.0AH

60min +/- 10min

CE RoHS

INCLUYE:

CARGADOR 12V
PARA REF. 60026

60025 31,60€

0.30 5 4 700



BATERÍA LI-ION 2.0Ah

PARA REF. 60024

60026 37,90€

0.20 8 5 1400



IVA no incluido

JBM / www.jbmcamp.com

TALADRO PERCUTOR 2 VELOCIDADES A BATERÍA

60006 182,00€

2.50	-	4	68
Kg	Sub	Up	Box

Batería no incluida.

Esta herramienta ha sido diseñada para realizar **tareas de perforación en metal y madera**, tareas de **perforación con impacto, en ladrillo, hormigón y piedra**, así como para **tensar, aflojar y desenroscar tuercas y tornillos**.

Cuenta con un anillo de conversión funcional que permite configurar la herramienta entre el **modo taladro**, **taladro con impacto** o el modo **destornillador**, un anillo de ajuste que permite elegir **23 niveles de torque diferentes**, un **selector de velocidad**, y un **portabrocas sin llave de 1/2"** para una inserción y extracción rápida y eficaz de las brocas.

PORTABROCAS

14643 24,50€

INTERRUPTOR

14644 8,00€

ROTOR

14645 45,00€

PLACA BASE + ESTATOR

14646 110,00€

MANGO AUXILIAR

14954 14,50€

BRUSHLESS MOTOR

20V 80 Nm **1/2"** 29750IPM

0-500 RPM 0-1750 RPM **LED**

PORTABROCAS: 2-13MM (1/2")

MANGO AUXILIAR

- Contiene:
Luz led incorporada.
Interruptor de velocidad variable.
Empuñadura ergonómica.
Mango auxiliar.
Gancho de transporte.

CONSUMIBLES

página 109-111

BROCAS PARA ALBAÑILERÍA

53861

3-10MM

8
PCS

53860

4-10MM

5
PCS

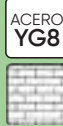

ESTUCHE DE BROCAS HELICOIDALES HSS-G 4341

53852

1-10MM

170
PCS

53856

1-13MM

25
PCS

ESTUCHE DE PUNTAS DE IMPACTO CON ADAPTADOR RÁPIDO S2

53857

49
PCS

53858

21
PCS

SIERRAS DE CORONA

53859

8
PCS

HSS M42
4-6TPI

AMOLADORA ANGULAR A BATERÍA

Diámetro del disco: **115mm (4-1/2")**

Diámetro del disco: **125mm**

60008 141,00€

1.85	-	4	156
Kg	Sub	Up	Box

60028 142,00€

1.95	-	4	144
Kg	Sub	Up	Box

Esta amoladora angular ha sido diseñada para realizar todo tipo de tareas, tales como **cortar, pulir y lijar**.
- Tamaño del eje: **M14**.

Batería no incluida.
Disco no incluido.

BRUSHLESS MOTOR

20V **1** **M14**
8000 RPM

- Contiene:
Cubierta protectora.
Mango auxiliar.
Llave de ajuste.

ROTOR

14652 47,00€

INTERRUPTOR

14653 5,25€

PLACA BASE + ESTATOR

14654 104,00€

ENGRANAJE #13

14655 5,95€

PLACAS DE FIJACIÓN

14656 4,50€

COJINETE #23

14657 4,50€

ENGRANAJE #22

14766 3,15€

COJINETE #29

14767 2,34€

MANGO AUXILIAR

14956 4,40€

CUBIERTA PROTECTORA DE 115MM

14957 4,10€

CUBIERTA PROTECTORA DE 125MM

14808 3,05€

TUERCA DE SUJECIÓN RÁPIDA M14

15014 20,00€

CONSUMIBLES

página 112

DISCOS DE CORTE PARA METAL / PARA ACERO INOXIDABLE

14893

T42



14900

T41



TUERCA DE SUJECIÓN RÁPIDA M14 PARA AMOLADORA ANGULAR

15014



MARTILLO PERCUTOR SDS A BATERÍA

60023 212,00€

3.10 - 6 120
Kg sub 11 120

Batería no incluida.

Esta herramienta ha sido diseñada para realizar tareas de **cincelado y perforación con impacto en hormigón y ladrillo**

- Portabrocas tipo **SDS**.



BRUSHLESS MOTOR

20V 4750BPM 2.2 J 1350 RPM

28mm 22mm 13mm

SDS

- Contiene:
- 1 cubierta antipolvo.
- 1 medidor de profundidad.
- 1 mango auxiliar.
- 1 cincel en punta.
- 1 cincel plano.
- 3 brocas SDS: 8/10/12 x 150mm.
- Llave de ajuste.



PALANCA DE IMPULSO 14693 3,50€	ANILLO DE SELLADO 14698 1,00€	CUBIERTA ANTIPOLVO 14967 5,50€
COJINETE OSCILANTE 14694 11,50€	ROTOR 14699 30,00€	MEDIDOR DE PROFUNDIDAD 14968 6,00€
MARTILLO DE IMPACTO 14695 4,00€	COJINETE #61 14700 2,50€	
CILINDRO DE AIRE 14696 18,00€	PLACA BASE 14702 92,00€	
INTERRUPTOR 14697 8,00€	COJINETE #67 14701 2,50€	

CONSUMIBLES: CINCELES Y BROCAS

página 109

14837 EN PUNTA - 14x250mm	14839 PLANO - 20x250mm	14841 ADAPTADOR	14842 PORTABROCAS	53850 ESTUCHE SDS-PLUS
14838 PLANO - 40x250mm	14840 ACANALADO - 250mm			

LIJADORA ORBITAL A BATERÍA

60033 104,00€

13.50 - 4 144
Kg sub 11 144

Batería no incluida.

Esta herramienta está diseñada para **lijar madera, hierro, plástico y materiales similares** utilizando el papel de lija adecuado. Esta lijadora es ajustable a tres velocidades diferentes, cuenta con una empuñadura confortable y lleva incorporada una bolsa de recogida de polvo.



20V

6000 RPM
8000 RPM
10000 RPM

0°C
45°C

x3 SPEED
150mm

BOLSA RECOGE POLVO 15530 7,50€	RODAMIENTO 15533 4,50€	RODAMIENTO 15536 14,50€
SOPORTE PARA LA BOLSA RECOGE POLVO 15531 5,00€	RODAMIENTO 15534 4,50€	BLOQUE DE GOMA PARA FRENO 15537 6,00€
PLACA BASE + ESTATOR + INTERRUPTOR 15532 98,00€	BASE DE RODAMIENTO 15535 3,50€	BASE PLATO 15538 17,00€

Utilízalas con las baterías JBM: una única batería apta para todas las herramientas

BATERÍAS LI-ION

2.0Ah 60012	4.0Ah 60013	6.0Ah 60015
-----------------------	-----------------------	-----------------------

CARGADORES

4A 60016	CARGA RÁPIDA 6A 60017
--------------------	---------------------------------

PULIDORA A BATERÍA

60009 168,00€

2.65	-	4	80
Kg	sub	ff	

Batería no incluida.



Esta herramienta ha sido diseñada para llevar a cabo procesos de acabado, tales como **pulir y redondear bordes y esquinas**, así como para conseguir un **correcto alisado de superficies** mediante su rueda y almohadilla de pulido. La velocidad de la rueda es **ajustable a 9 niveles** distintos a través del selector de velocidad, y el **gatillo puede bloquearse** para un uso continuo de la herramienta o para su almacenamiento, previniendo así un arranque accidental.

Contiene:

- Almohadilla de pulido.
- Mango auxiliar en D.
- Llave Allen hexagonal.
- Selector de velocidad de 9 fases: 800, 1000, 1200, 1400, 1600, 1800, 2000, 2200, 2400.
- Empuñadura ergonómica.
- Interruptor de seguridad.
- Cierre de eje.



BRUSHLESS MOTOR

20V

800-2400 RPM

M14

VELOCIDAD AJUSTABLE

Ø 180mm

ROTOR

14658 45,00€

PLACA BASE + ESTATOR

14660 83,00€

COJINETE #24

14662 2,50€

ALMOHADILLA DE PULIDO

14958 22,00€

INTERRUPTOR

14659 5,00€

ENGRANAJE

14661 9,00€

COJINETE #26

14663 2,50€

MANGO AUXILIAR EN D

14959 10,00€



CEPILO A BATERÍA

60020 175,00€

3.15	-	4	72
Kg	sub	ff	

Batería no incluida.

Esta herramienta está diseñada para realizar **tareas de carpintería**. Se puede utilizar para lograr un **acabado liso** en superficies de madera y realizar **tareas de rebaje**.

Esta herramienta tiene una **base de aleación de aluminio** para proporcionar una mayor precisión, un **sistema de colección del polvo** resultante de la operación, así como un **botón de bloqueo del gatillo** para evitar un arranque accidental de la herramienta.

- Contiene:
- 1 perilla de ajuste de la profundidad de galce.
- 1 guía paralela.
- 3 perillas de fijación.
- 1 llave de ajuste.
- 1 tornillo.



BRUSHLESS MOTOR

20V

10000 RPM

10,5mm

82mm

Ø 2mm

- Características:
- Pomo de ajuste de la profundidad de corte.
- Base de aluminio.
- Interruptor de bloqueo del gatillo.
- Sistema de colectores de polvo.
- Empuñadura ergonómica.

ESTATOR

14936 27,50€

CORREA DE TRANSMISIÓN

14684 3,00€

GUÍA DE PROFUNDIDAD DE GALCE

14964 8,00€

INTERRUPTOR

14685 5,00€

GUÍA DE CORTE PARALELA

14965 8,50€

PLACA BASE

14686 73,00€

ROTOR

14687 35,00€





- Incluye:
Hoja para
madera.
Hoja para
metal.

SIERRA DE SABLE A BATERÍA

60019 178,00€

3,45 - 4 112

Batería no incluida.



Diseñada para realizar **tareas de corte en un gran variedad de materiales y ser usada para múltiples aplicaciones**. Su diseño permite **cambiar la hoja de corte de manera rápida y precisa**, gracias a su sistema de anclaje sin necesidad de utilizar herramientas, así como adaptar la velocidad de corte dependiendo de la operación que vaya a realizar.



PALANCA RECIPROCANTE

14680 17,00€

PLACA BASE

14683 86,00€

PLACA BASE + ESTATOR

14681 108,00€

ROTOR

14770 40,00€

INTERRUPTOR

14682 9,00€

CONSUMIBLES REF. 60019

página 112

14995

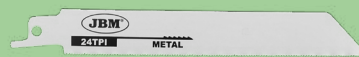

14994



CONSUMIBLES REF. 60010

página 112

14993



14991



SIERRA DE CALAR A BATERÍA

60010 170,00€

Batería no incluida.

2,80 - 4 144



Esta herramienta ha sido diseñada para realizar tareas de **corte en diferentes materiales**, tales como **madera, acero, plástico y metal**. Cuenta con **4 niveles de acción pendular**: 3 acciones de corte orbitales y una acción de corte recto, que permiten ajustar la velocidad de la hoja según la dureza del material a cortar.



20V

Max: 13,5mm
Max: 8.1mm

26mm

2600 SPM LED

PLACA BASE + ESTATOR

14664 100,00€

INTERRUPTOR

14665 8,80€

PLACA BASE

14666 97,00€

ENGRANAJE

14667 8,80€

PALANCA RECIPROCANTE

14668 7,70€

RODILLOS DE GUÍA

14670 4,50€

ROTOR

14768 28,80€

TUBO DEL POLVO

14960 3,85€

GUÍA DE CORTE PARALELA

14961 3,95€

- Contiene:
Hoja para madera.
Guía de corte.
Adaptador para el conducto del polvo.

- Características:
Caja de engranajes metálica.
Empuñadura ergonómica blanda.
Interruptor de velocidad variable.
4 niveles de acción pendular.
Base de aluminio.
Luz led incorporada.
Interruptor de seguridad.

Utilízalas con las baterías JBM: una única batería apta para todas las herramientas

BATERÍAS LI-ION

2.0Ah



60012

4.0Ah



60013

6.0Ah



60015

CARGADORES



4A
60016



CARGA RÁPIDA
6A
60017

MINI SIERRA CIRCULAR A BATERÍA

60011 175,00€

2,55 - 4 128



Batería no incluida.

Esta herramienta ha sido diseñada para realizar tareas de **corte en madera**. La **hoja de sierra de 115 mm de diámetro y 24 dientes** hace que sea ideal para realizar **cortes longitudinales y transversales rectos** en paneles y tabloncillos de madera, así como cortes en **ángulo de hasta 45°**.

Cuenta también con un **botón de bloqueo del gatillo** para prevenir un arranque accidental de la herramienta, y una **protección de aluminio**.



- Contiene:
Hoja de 115mm 24T TCT.
Guía de corte.
Tubo para el polvo.
Llave hexagonal.

- Características:
Interruptor de seguridad.
Empuñadura ergonómica.
Protección de aluminio.
Sistema colector de polvo.

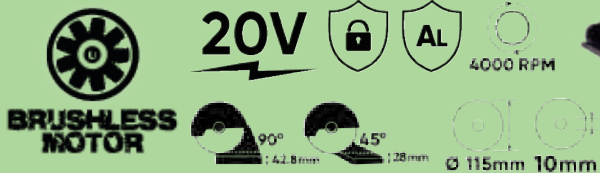

ROTOR

14671 44,00€

PLACA BASE + ESTATOR

14674 73,00€

GUÍA DE CORTE PARALELA

14963 7,50€

INTERRUPTOR

14672 5,00€

TUBO DEL POLVO

14962 6,50€



CONSUMIBLES REF. 60011

página 112

Hoja de sierra circular 24T 115mm

14989 14986



CONSUMIBLES REF. 60007

página 112

Hoja de sierra circular 24T 165mm

14988 14985



SIERRA CIRCULAR A BATERÍA

60007 170,00€

Batería no incluida.

3,75 - 4 60



Esta herramienta ha sido diseñada para realizar tareas de **corte en madera**. La **hoja de sierra de 165 mm de diámetro y 24 dientes** hace que sea ideal para realizar **cortes longitudinales y transversales rectos** en paneles y tabloncillos de madera, así como **cortes en ángulo de hasta 45°**.

- Características:
Interruptor de seguridad.
Empuñadura ergonómica.
Protección de aluminio.
Luz LED incorporada.



INTERRUPTOR

14647 3,00€

ENGRANAJE

14650 5,00€

GUÍA DE CORTE PARALELA

14955 7,50€

ROTOR

14649 50,00€

PLACA BASE + ESTATOR

14651 86,00€

- Incluye:
Hoja TCT de 24dientes de 165mm.
Guía de corte.
Llave hexagonal.





INGLETADORA A BATERÍA

60022 470,00€

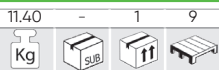

Batería no incluida.

Viene equipada con una **bolsa de extracción para el polvo**, una **guía láser**, una **llave de ajuste** para la inserción y extracción de la hoja de corte, y una **prensa de sujeción de la pieza de trabajo**. Además, cuenta con un **botón de seguridad** para activar el gatillo para prevenir un arranque accidental de la herramienta.

BRUSHLESS MOTOR 30A

20V LASER 3500 RPM

90°	90°	45°	90°
205mm	50mm	152mm	50mm
90°	65°	45°	45°
205mm	138mm	138mm	152mm

Ø185mm 25.4mm

- MOTOR
14691 167,00€
- INTERRUPTOR
14692 5,50€
- BOLSA DE EXTRACCIÓN DEL POLVO
14966 7,50€



- Contiene:
- 1 hoja de corte de 40 dientes.
- 1 abrazadera de sujeción.
- 1 llave para la hoja de corte.
- 1 bolsa de extracción del polvo.



CONSUMIBLES REF. 60022

página 112

Hoja de sierra circular 40T 185mm

14990 **14987**



- Material: puntas YG8, cuerpo de carburo de tungsteno



Utilízalas con las baterías JBM: una única batería apta para todas las herramientas

BATERÍAS LI-ION

2.0Ah



60012

4.0Ah



60013

6.0Ah



60015

CARGADORES



4A
60016



CARGA RÁPIDA
6A
60017



MULTIHERRAMIENTA OSCILANTE A BATERÍA

60041 77,00€

1.60 - 4 216



Batería no incluida.



PALANCA DE BLOQUEO

15320 1,00€

RODAMIENTO DE BOLA 625

15321 3,00€

REGULADOR DE VELOCIDAD

15324 18,00€

PLACA BASE

15325 3,50€

CUBIERTA INTERMEDIA

15322 3,50€

MOTOR

15323 24,00€

JUNTA

15326 1,00€

MANGO AUXILIAR

15327 5,50€

La multiherramienta eléctrica oscilante le permite acoplar diferentes tipos de accesorios para poder realizar variados trabajos. Es especialmente útil para hacer rascados, lijados y vaciados en espacios estrechos.



20V
BRUSHLESS MOTOR



CONSUMIBLES

página 111

SET DE CLAVOS BRAD DE CALIBRE 18

53999

54000

54002

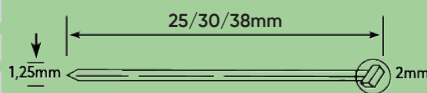

SET DE GRAPAS DE CALIBRE 18

54008

54010

54011

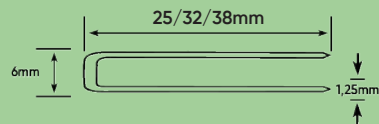

CLAVADORA A BATERÍA

60037 222,00€

3.60 - 4 128



Batería no incluida.

20V 2000Ah

MAX 100 grapas por minuto

50 grapas por minuto

Capacidad máxima del cargador: 100 grapas por hora

100



Esta herramienta está diseñada para el clavado y grapado de cartón, material aislante, tela, láminas, cuero y materiales similares en superficies de madera o materiales similares a la madera.

Viene equipada con una luz LED para indicar el estado de la herramienta; una luz LED para una mayor visibilidad durante la operación; un selector para seleccionar entre el modo de disparo simple o por contacto, para un disparo más preciso o rápido; y una rueda de ajuste para seleccionar la profundidad de

disparo de las cabezas de los clavos/grapas. También cuenta con un gancho de transporte para el cinturón y una empuñadura ergonómica blanda.

Además, viene equipada con un **pasador de contacto de seguridad**, que debe ser presionado contra la pieza de trabajo antes de accionar el gatillo para disparar clavos/grapas en el modo de disparo simple, funcionando como un mecanismo de seguridad para prevenir un arranque accidental de la herramienta.



Longitud máxima de los clavos	50 mm
Clavos BRAD de calibre 18	
Anchura máxima de la sección transversal del clavo	1.25 mm
Grosor máximo de la sección transversal del clavo	1.05 mm

Longitud máxima de las grapas	40 mm
Grapas de corona estrecha de calibre 18 de uso ligero	
Anchura máxima de la sección transversal de la grapa	1.2 mm
Grosor máximo de la sección transversal de la grapa	1 mm
Corona máxima de las grapas	6 mm

CONJUNTO PIN DE CONTACTO

15276 46,00€

CUBIERTA DE SELLADO

15277 9,00€

MARCO DE SEGURIDAD

15278 3,50€

MOTOR

15279 69,00€

CONMUTADOR

15280 91,00€

Utilízalas con las baterías JBM: una única batería apta para todas las herramientas

BATERÍAS LI-ION

2.0Ah



4.0Ah



6.0Ah



CARGADORES

4A



CARGA RÁPIDA

6A



PISTOLA ENGRASADORA A BATERÍA

60038 255,00€

Batería no incluida.

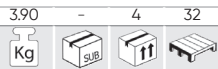

Esta herramienta ha sido diseñada para **tareas de lubricación** y puede ser fácilmente transportada y manipulada en cualquier lugar gracias a su diseño sin cables.

Está equipada con una luz de trabajo LED para una mayor visibilidad en el área de trabajo, una válvula de purga de seguridad para evitar la presión excesiva y el atasco, una empuñadura blanda ergonómica para un mejor control y un botón de bloqueo del gatillo para evitar un arranque accidental de la herramienta. Además el cuadal de salida de la grasa se puede cambiar hasta **8 marchas distintas** mediante la rueda de ajuste de la velocidad.



20V	9000PSI 620BAR	Volumen de flujo volumen flow rate 200g/min	Capacidad de grasa en cartucho hasta Grasas lubricantes capacity and type 420g	Capacidad de grasa a granel Bulk grease capacity 600g	Tipo de grasa hasta Grease type up to NLGI #2	Niveles de velocidad flow lever 8
						760mm



BOMBA 15380 169,00€	PLACA BASE 15382 42,00€	MICROGATILLO 15381 5,50€	MANGUERA FLEXIBLE 15440 33,00€
--------------------------------------	--	---	---

PISTOLA DE SILICONA A BATERÍA

60032 123,00€

Batería no incluida.

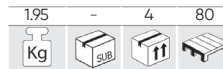

Esta herramienta está diseñada para **sellar cualquier hueco o grieta en una amplia variedad de materiales** como metal, vidrio, madera y cerámica. Viene equipada con una **luz LED** para una mejor visibilidad al trabajar en sitios oscuros, un **selector de velocidad variable** y un **sistema de bloqueo** del gatillo. Además, presenta un **sistema antigoteo**. Después de soltar el gatillo 0.2-0.3s, el tiempo de encolado posterior es de 0.8s.



20V	2500 Nm	LED	VELOCIDAD AJUSTABLE	MECANISMO ANTIGOTEO ANTI-DROP MECHANISM
300ml	0.5-8mm/s			

MOTOR 15126 19,50€	PLACA BASE 15127 29,00€
-------------------------------------	--



Utilízalas con las baterías JBM: una única batería apta para todas las herramientas

BATERÍAS LI-ION



CARGADORES



PISTOLA DE CALOR A BATERÍA

60042 106,00€

1.00 - 4 240



Batería no incluida.

La pistola de calor eléctrica se utiliza principalmente para la **retracción de PVC, soldadura, curvado de piezas de plástico y secado ordinario, fusión y descongelación.**



MOTOR

15719 11,00€

ELEMENTO CALEFACTOR

15720 59,00€

PLACA BASE

15721 46,00€

20V

15A

550°C
1022°F

Max.
200L/min.

0.6kg

Ø 34mm

PA6-GF30+TPE



PULVERIZADOR DE PINTURA A BATERÍA

60043 123,00€

1.70 - 3 90



Esta herramienta está diseñada para pulverizar pintura en superficies de interior y de exterior.

Batería no incluida.

BOQUILLA

15722 4,25€

VALVULA

15723 2,21€

ARANDELA DE SELLADO

15724 2,82€

JUNTA TORICA

15725 1,86€

ARANDELA DE SELLADO

15726 2,82€

TANQUE PARA PINTURA

16150 7,90€

1,3 kg 900ML 20V 280W

20m

2,5mm

60 DIN

700ml/min PA6 y PP



El pulverizador dispone de tres modos diferentes de pulverización: circular, horizontal y vertical.



Utilízalas con las baterías JBM: una única batería apta para todas las herramientas

BATERÍAS LI-ION

2.0Ah



60012

4.0Ah



60013

6.0Ah



60015

CARGADORES



4A
60016



CARGA RÁPIDA
6A
60017

ASPIRADOR PORTÁTIL

60001 88,00€

1.70	-	4	64
Kg	sub	ff	

Batería no incluida.

Este aspirador eléctrico **sin cable** ha sido diseñado para **eliminar y aspirar** cualquier resto de polvo u otro material que no sea dañino para la salud.

La **batería recargable** hace que sea **fácil de transportar** de un sitio a otro y los diferentes accesorios permiten realizar labores de limpieza en multitud de sitios y rincones distintos.



- Contiene:
1 boquilla para juntas.
1 tubo de extensión.
1 boquilla con cepillo.
1 boquilla para suelos.



20V

3.8 kPa 500ml

FILTRO	TUBO DE EXTENSIÓN	BOQUILLA PARA SUELOS
14628 2,50€	14950 6,50€	14952 19,00€
INTERRUPTOR	BOQUILLA PARA JUNTAS	BOQUILLA CON CEPILLO
14629 4,00€	14951 9,50€	14953 8,50€
MOTOR	FILTRO CON CARCASA PARA ASPIRADOR PORTÁTIL	
14630 22,00€	15765 14,00€	

COMPRESOR E INFLADOR A BATERÍA

60003 110,00€

Batería no incluida.

1.85	-	4	100
Kg	sub	ff	

Este inflador le permite inflar ruedas de automóvil y motocicletas, pelotas, lanchas neumáticas, colchones inflables, etc.



- Contiene:



BOMBA

14634 36,50€

SELECTOR DEL MODO DE TRABAJO

14631 3,50€

SOPLADOR

14635 10,00€

INTERRUPTOR DE LA LUZ LED

14632 3,50€

MANGUERA ALTA PRESIÓN

15151 10,50€



12L/MIN



380L/MIN

Longitud manguera alta presión: **760 mm**
Longitud manguera alta capacidad: **460 mm**



Utilízalas con las baterías JBM: una única batería apta para todas las herramientas

BATERÍAS LI-ION

2.0Ah



60012

4.0Ah



60013

6.0Ah



60015

CARGADORES



60016



CARGA RÁPIDA
6A
60017

FARO DE TRABAJO LED A BATERÍA

60004 79,00€

1,45	-	4	96
Kg	SUB	↑↑	↑↑

Batería no incluida.

Este faro de trabajo LED ha sido diseñado para garantizar una **perfecta iluminación** del área de trabajo y cualquier otro lugar. Su funcionamiento con la batería de litio portátil hace que sea **ideal para moverlo libremente de un sitio a otro, y en situaciones donde no se tiene acceso al suministro eléctrico**. Aun así, si la batería se agota, es posible conectar el **cable de alimentación** provisto en la ranura de la parte trasera del faro y enchufarlo a la toma de corriente de 230V.

- Contiene:
Cable de alimentación.



1,5m



20V 2400 LED LM

INTERRUPTOR

14636 30,00€

TRÍPODE PARA FARO DE TRABAJO LED (REF. 60004)

15049 37,40€

2,10	-	4	120
Kg	SUB	↑↑	↑↑

↑1200mm
↓595mm



280mm

325mm

275mm

1200mm

ÁNGULO DE AJUSTE DE 360°



PORTÁTIL DE TRABAJO LED A BATERÍA

60035 30,00€

0,40	-	5	475
Kg	SUB	↑↑	↑↑

Batería no incluida.

Este faro de trabajo LED ha sido diseñado para garantizar una **perfecta iluminación del área de trabajo** y cualquier otro lugar. Su funcionamiento con la batería de litio portátil hace que sea **ideal para moverlo libremente de un sitio a otro, y en situaciones donde no se tiene acceso al suministro eléctrico**.

La lente de luces LED proporciona una potencia de luz que puede ajustarse a **500 y 1000 lúmenes**, y el cabezal del faro tiene un **ángulo de ajuste de 90°** para adaptar la dirección de la luz según convenga. También incluye una empuñadura blanda ergonómica para un mayor control y confort y un gancho para poder colgarlo a cualquier objeto.



20V
10W

500 Lm
1000 Lm
220-240V 50Hz
Parpadeante Flashing



FUENTE DE LUZ

15124 9,50€

PLACA BASE

15125 23,00€



Utilízalas con las baterías JBM: una única batería apta para todas las herramientas

BATERÍAS LI-ION

2.0Ah



60012

4.0Ah



60013

6.0Ah



60015

CARGADORES



4A
60016



CARGA RÁPIDA
6A
60017

HIDROLIMPIADORA A PRESIÓN A BATERÍA

60039 265,00€

3.30	-	2	36
Kg	SUB	↑	↑

Batería no incluida.

La hidrolimpiadora a presión eléctrica brushless está diseñada para limpiar vehículos, equipos, herramientas, muebles de exterior, etc.



319-507 PSI
22-25 BAR

20V

2.0-2.4 L/min

2.0 kg



Incluye una boquilla regulable para adaptar la salida del chorro de agua al tipo de suciedad y superficie sobre la cual se aplica.

TAPON ROSCADO PARA VÁLVULA INTERIOR

15481 4,50€

CONECTOR PARA TUBO DE LA VÁLVULA INTERIOR

15484 5,50€

SET DE 6 VÁLVULAS UNIDIRECCIONALES

15487 59,00€

VÁLVULA DE NO RETORNO PARA TUBO DE ENTRADA Y SALIDA

15490 4,00€



ARANDELA SUPERIOR PARA EL MUELLE DE LA VÁLVULA INTERIOR

15482 4,00€

ANILLO HERMETICO PARA INTERRUPTOR

15485 4,00€

ANILLO HERMETICO PARA TUBO INTERIOR Y EXTERIOR

15488 4,00€

MUELLE PARA VÁLVULA DE ESCAPE

15491 4,00€

MUELLE PARA VÁLVULA INTERIOR

15483 4,00€

INTERRUPTOR PARA PISTOLA LIMPIADORA

15486 9,00€

TUBO DE ENTRADA Y SALIDA

15489 10,50€

TUBO ACODADO

15492 5,00€

MUELLE

15493 4,50€

PULVERIZADOR DE MOCHILA 15L A BATERÍA

60027 99,00€

5.65	-	1	15
Kg	SUB	↑	↑

Batería no incluida.
Compatible con 60012 - 60013

Adecuado para la **desinfección medioambiental** de hogares, lugares públicos, explotaciones ganaderas, jardines, etc., contribuyendo a la **erradicación de todo tipo de partículas infecciosas y su divulgación**, así como la **prevención de plagas y enfermedades**.

Bomba de diafragma con un **interruptor de presión inteligente** que puede ser bloqueado para un uso continuo. Equipada con **4 cabezales diferentes intercambiables** para adaptar la potencia y flujo de pulverización según la necesidad requerida: 1 cabezal de cono hueco, 1 cabezal de doble cono hueco, 1 cabezal de 4 salidas, 1 cabezal de aire inducido.

Lanza telescópica extensible.



20V

15L

0.3-0.45 Mpa

1-1.2m

40 - 80cm

Tapa con un diseño de sellado a prueba de fugas

Mango para transportar fácilmente

Soporte para colocar la lanza



Almohadilla para la espalda **TRANSPIRABLE Y ERGONÓMICA** que evita la sensación de pesadez cuando se utiliza durante un periodo largo de tiempo y facilita la transpiración y evaporación del sudor.



- Contiene:

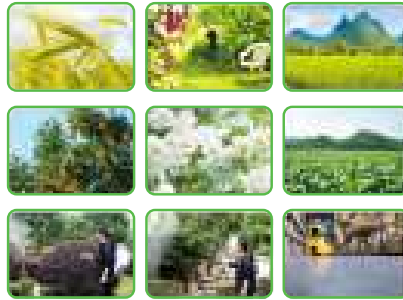

Utilízalas con las baterías JBM: una única batería apta para todas las herramientas

BATERÍAS LI-ION

2.0Ah



60012

4.0Ah



60013

6.0Ah



60015

CARGADORES



4A
60016



CARGA RÁPIDA
6A
60017



MOTOSIERRA A BATERÍA

60029 240,00€

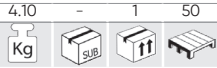

Batería no incluida.

Esta herramienta ha sido diseñada para realizar **tareas forestales en madera** tales como la tala de árboles y cortar ramas y troncos, entre otras. Está equipada con una perilla para ajustar la barra guía y la tensión de la cadena y un protector frontal para frenar la cadena en caso de contragolpe. Además, presenta un **sistema de lubricación automático** de la cadena y un botón de **bloqueo del gatillo** para prevenir un arranque accidental de la herramienta. También incluye una barra guía, una cadena y una **cubierta para proteger** tanto la barra como la cadena para su almacenaje y transporte.

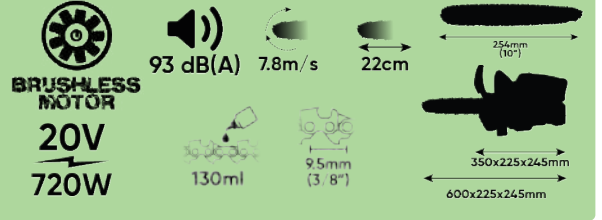

INTERRUPTOR DE SEÑAL

15098 11,50€

BOMBA DE ACEITE

15101 11,00€

CADENA

15104 31,50€

GATILLO

15099 5,50€

ROTOR

15102 40,00€

BARRA GUÍA

15105 30,00€

PLACA BASE

15100 70,00€

ESTÁTOR

15103 20,50€

MANGO AUXILIAR EN D

15106 15,00€

CONJUNTO DE LIMAS PARA CADENA DE MOTOSIERRA

54128 10,50€



CORTASETOS A BATERÍA

60031 142,00€

3.45 - 1 24



Batería no incluida.

Esta herramienta está diseñada para realizar **tareas de jardinería** como recortar, cortar o podar setos o arbustos **de forma rápida y cómoda**. Alimentada con una batería de iones de litio, es ideal para ser transportada de un sitio a otro gracias a su diseño sin cables y su peso ligero.

Viene equipada con una **cubierta para la cuchilla** para ayudar a mantener la herramienta en buenas condiciones, una **protección** para desviar las astillas u otros desechos lejos **de las manos y los ojos del usuario**, y un **mango auxiliar** para un mejor control y comodidad. Además, cuenta con dos interruptores y un **botón de bloqueo** para evitar un arranque accidental de la herramienta.

20V
230W



GATILLO TRASERO

15114 6,00€

CUCHILLA DE CORTE

15118 52,00€

MICRO INTERRUPTOR #8

15115 8,50€

MICRO INTERRUPTOR #31

15119 10,00€

PLACA BASE

15116 29,50€

GATILLO FRONTAL

15120 6,50€

MOTOR

15117 29,50€

MANGO AUXILIAR EN D

15121 12,00€



Utilízalas con las baterías JBM: una única batería apta para todas las herramientas

BATERÍAS LI-ION

2.0Ah



60012

4.0Ah



60013

6.0Ah



60015

CARGADORES



4A
60016



CARGA RÁPIDA
6A
60017

DESBROZADORA MULTIFUNCIÓN A BATERÍA 4 EN 1

60040 440,00€

Batería no incluida.

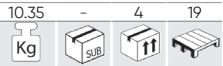

La máquina eléctrica multifunción 4 en 1 está diseñada para una multitud de tareas al aire libre, como desbrozar los espacios verdes, arreglar los setos del jardín, cortar ramas, etc. Es un producto ideal para el mantenimiento integral del jardín.

- Contiene



- Incluye una sierra de pértiga, un corta setos y una desbrozadora con un cabezal de hilo y un disco de corte de tres puntas.

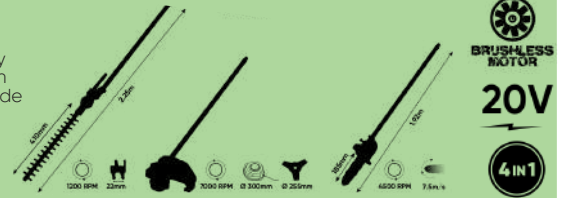

COJINETE

15462 7,50€

ENGRANAJE

15465 11,50€

LLAVE

15468 2,50€

GUIA PARA SIERRA DE PÉRTIGA

15471 20,10€

CADENA PARA SIERRA DE PÉRTIGA

15472 19,00€

CABEZAL PARA DESBROZADORA

15473 13,70€

ROTOR

15463 114,00€

COJINETE

15466 6,50€

EJE DE SALIDA

15469 9,50€

HILO PARA DESBROZADORA

15474 8,50€

DISCO DE CORTE DE TRES PUNTAS PARA DESBROZADORA

15475 8,50€

COBERTURA PARA DESBROZADORA

15476 11,00€

COJINETE

15464 6,50€

ENGRANAJE

15467 14,00€

COJINETE

15470 7,50€

BASE DE COBERTURA PARA DESBROZADORA

15477 5,70€

CUCHILLA PARA DESBROZADORA

15478 3,60€



SOPLADOR A BATERÍA

60030 112,00€

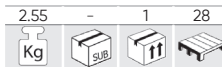

Batería no incluida.

Esta herramienta ha sido diseñada para **barrer hojas, pasto, papel y otros materiales similares**. Alimentada con una batería de iones de litio, es ideal para transportarla de un lugar a otro gracias a su diseño sin cables y su peso ligero.

Viene equipada con un interruptor para una configuración de **alta o baja velocidad de flujo de aire y volumen**, y una **empuñadura ergonómica blanda** para un mayor control y agarre.

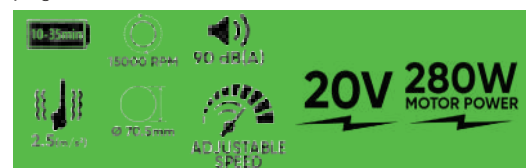

MICRO INTERRUPTOR

15107 4,00€



PLACA BASE

15109 25,50€



MOTOR

15111 30,40€



BAJA

22m/s (49MPH)
312m³/h (116CFM)



ALTA

38m/s (85MPH)
520m³/h (186CFM)

TUBO DE SOPLADO

15113 11,80€

GATILLO

15108 2,16€

CONMUTADOR

15110 6,55€

CONO DE ENTRADA

15112 3,25€

Utilízalas con las baterías JBM: una única batería apta para todas las herramientas

BATERÍAS LI-ION

2.0Ah



60012

4.0Ah



60013

6.0Ah



60015

CARGADORES



4A
60016



CARGA RÁPIDA
6A
60017

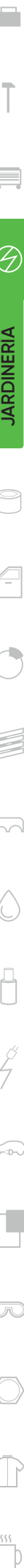

ROBOT CORTACÉSPED

52598 1.080,00€

17,00 - 1 12



- Robot autónomo cortacésped.
- Fácil de almacenar e inalámbrico.
- Delimitación del espacio de trabajo mediante hilo perimetral



5200 mAh Capacidad de la batería Battery capacity	1400m² Superficie de corte Mowing area	2,5H 	2H 	22m/min
115,44W Consumo de energía Power consumption	AC 100-240V 50 / 60Hz Frecuencia de entrada Input Voltage	DC 15-25,5V Tensión de salida Output Voltage	IP X4	70 dB

Altura de corte:
2,5 - 5,5cm

Ancho de corte: 18cm

Estación de carga

Velocidad de giro de la cuchilla: 3500rpm



CONEXIÓN APP



GRAPAS PARA CABLE DELIMITADOR 150 PCS

15425 50,00€

MOTOR RUEDA TRASERA

15434 147,00€

HOJA DE CORTE Y TORNILLOS 3 PCS

15426 10,00€

PLACA DE LA CORTE Y PLACA DE PROTECCIÓN

15435 24,50€

RUEDAS DELANTERAS

15439 52,00€

MOTOR DE CORTE

15436 97,00€

CLAVOS PARA ESTACIÓN DE ACOPLAMIENTO 4 PCS

15427 9,00€

PLACA BASE

15437 305,50€

BATERÍA 22.2V, 2600MAH

15428 238,00€

SENSOR DE CABLE DELIMITADOR

15438 31,00€

ESTACION DE CARGA

15431 241,00€

CABLE DE EXTENSIÓN 5M

15429 23,50€

CONECTOR DE CABLE DE CONEXIÓN

15432 18,50€

ADAPTADOR

15430 83,00€

GARAJE PARA CORTACÉSPED

15433 197,00€

CABLE DELIMITADOR 150M

15424 105,00€

CORTACESPED DE BATERIA

60045 298,00€

11,60 - 1 6



Este cortador de césped autopropulsado a batería le permite mantener el césped de su jardín en perfecto estado. Está equipado con un motor brushless gracias al cual se consigue una mayor eficacia y menos nivel de ruido. Además, es muy ligero y fácil de maniobrar.

40V



800W



370x45mm

3300 RPM

4000 mAh
Capacidad de la batería
Battery capacity

IP X1

35L

96 dB(A)

Alturas de corte:
6 (25-75mm)



Ø 20,32cm

Ø 15,24cm

42cm

68cm

CABLE	VENTILADOR SOPORTE CUCHILLA	PLACA BASE - #68-4 (REF.60045)
16138 7,45€	16141 4,45€	16145 79,00€
BOLSA RECOGEDORA DE CESPED - #6 (REF.60045)	CUCHILLA DE 370MM - #20 (REF.60045)	INTERRUPTOR MINI - #68-10 (REF.60045)
16139 14,20€	16142 10,80€	16146 4,45€
ENSAMBLAJE DE ESTATOR - #32-13 (REF.60045)	TORNILLO PARA CUCHILLA - #21 (REF.60045)	ENGRANAJE GRANDE - #32-5 (REF.60045)
16149 38,60€	16143 2,06€	16147 13,00€
RUEDA POSTERIOR - #13 (REF.60045)	RUEDA DELANTERA - #23 (REF.60045)	ENSAMBLAJE DE ROTOR - #32-11 (REF.60045)
16140 14,20€	16144 12,80€	16148 35,40€
LLAVE DE SEGURIDAD PARA REF.60045 #61		
16160 3,99€		



BANDEJA SOPORTE

14622 17,00€

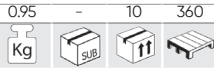

PARA REF. 60001, 60003, 60004, 60020

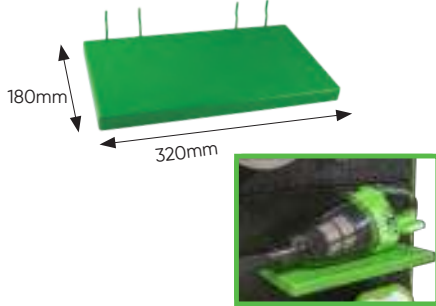

14624 17,00€

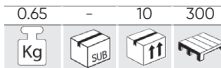

PARA REF. 60007, 60010, 60011

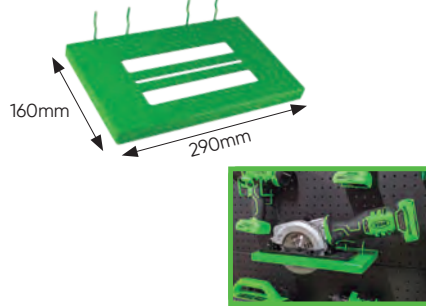

SOPORTE

14625 14,00€

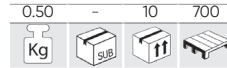

PARA REF. 60008, 60009

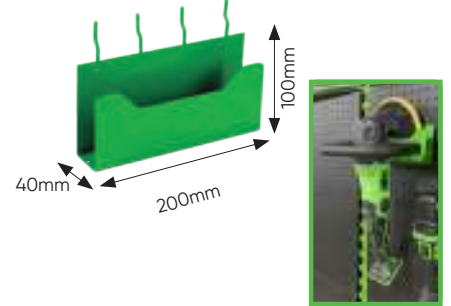

GANCHO

14623 8,00€

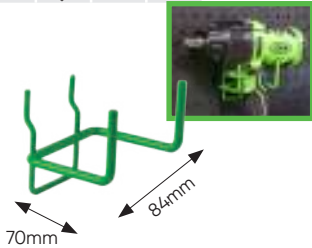
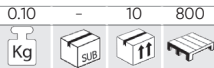

14626 7,00€

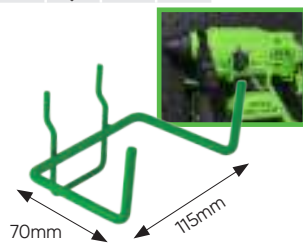
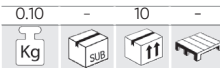

MOCHILA PARA HERRAMIENTAS ELÉCTRICAS

53702 28,50€

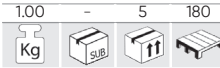

PEQUEÑA



53703 41,00€

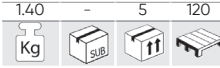

MEDIANA



53704 42,00€

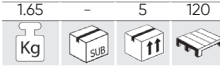

GRANDE



MOCHILA PARA HERRAMIENTAS ELÉCTRICAS - GRANDE

53782 14,00€

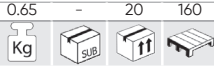

25Kg/13L



SEPARADOR INTERNO

BOLSILLOS DELANTEROS, POSTERIORES Y LATERALES

MOCHILA PARA HERRAMIENTAS

53258 67,00€

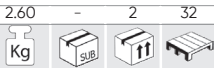

15Kg

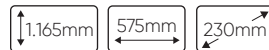

- No incluye herramientas.



MALETA DE HERRAMIENTAS

53253 98,00€

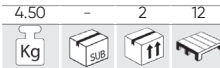

20Kg/18L

- 600D Polyester.
- No incluye herramientas.

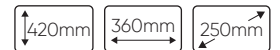

Utilízaslas con las baterías JBM: una única batería apta para todas las herramientas

Tres tipos de batería y dos tipos de cargador.
¡Escoge el que prefieras!

*Baterías y cargadores
NO INCLUIDOS
en las herramientas.



BATERÍAS LI-ION



INDICADORES DE CARGA LED



SISTEMA PROTECTOR DE CORTOCIRCUITOS



SISTEMA PROTECTOR DE SOBRECALENTAMIENTO



SISTEMA PROTECTOR DE SOBRECARGAS

20V

12V

2.0Ah



4.0Ah



6.0Ah



2.0Ah



60012 48,00€

0.45	-	30	920
Kg	Sub	ft	ft

60013 80,00€

0.75	-	5	700
Kg	Sub	ft	ft

60015 138,00€

1.00	-	20	600
Kg	Sub	ft	ft

PARA REF. 60024

60026 37,90€

0.20	8	5	1400
Kg	Sub	ft	ft

CARGADORES

50-60Hz



100V

240V



INDICADORES DE CARGA LED



SISTEMA PROTECTOR DE SOBRECALENTAMIENTO



SISTEMA PROTECTOR DE SOBRECARGAS

20V



SISTEMA PROTECTOR DE CORTOCIRCUITOS

12V



4A

60016 49,00€

0.80	-	5	210
Kg	Sub	ft	ft



6A
CARGA RÁPIDA

60017 64,00€

0.80	-	5	290
Kg	Sub	ft	ft



CARGADOR 12V
PARA REF. 60026

60025 31,60€

0.30	5	4	700
Kg	Sub	ft	ft

2.0AH 30min +/-10min 4.0AH 60min +/-15min

6.0AH 90min +/-15min

2.0AH 30min +/-10min 4.0AH 45min +/-10min

6.0AH 60min +/-15min

2.0AH 60min +/-10min

CINCELES SDS-PLUS

- Material: acero 40Cr, superficie arenada.
- Para albañilería: piedra, ladrillo, pared, hormigón, cemento, etc.



ACERO 40CR



60023

EN PUNTA - 14x250mm

14837 3,30€

0.30	5	4	700
Kg	Sub	Up	Down

PLANO - 40x250mm

14838 3,40€

0.25	10	100	-
Kg	Sub	Up	Down

ACANALADO - 250mm

14840 3,35€

0.27	10	50	-
Kg	Sub	Up	Down

PLANO - 20x250mm

14839 4,70€

0.29	10	50	-
Kg	Sub	Up	Down



ESTUCHE DE BROCAS SDS-PLUS PARA TALADRO PERCUTOR

53850 14,90€

0.65	5	25	1000
Kg	Sub	Up	Down



ACERO YG8

7 PCS

60023

5x110, 6x110, 6x160, 8x110, 8x160, 10x160, 12x160mm



PARA ALBAÑILERÍA

- Flauta simple, punta plana, superficie arenada.
- Material: puntas de aleación de acero YG8, cuerpo de acero al carbono.
- Para albañilería: piedra, ladrillo, pared, hormigón, cemento, etc.



DESPIECE DISPONIBLE

REF.	mm	Kg	Sub	Up	Down	€
14826	Ø 5x110mm	0,05	125	500		1,50€
14828	Ø 6x110mm	0,05	25	500		1,50€
14830	Ø 8x110mm	0,04	25	500		1,50€
14829	Ø 6x160mm	0,04	25	500		1,50€
14831	Ø 8x160mm	0,05	25	500		1,50€
14832	Ø 10x160mm	0,05	25	200		2,00€
14920	Ø 12x160mm	0,10	100	200		2,50€

TAMBIÉN TE PUEDE INTERESAR...

REF.	mm	Kg	Sub	Up	Down	€
14825	Ø 4x110mm	0,05	100	200		1,50€
14827	Ø 5x160mm	0,04	25	500		2,00€
14833	Ø 10x210mm	0,10	20	200		2,05€
14834	Ø 12x210mm	0,10	100	200		2,50€
14835	Ø 14x210mm	0,10	20	125		3,00€
14836	Ø 16x210mm	0,14	20	120		3,50€

ADAPTADOR SDS PLUS 1/2" PARA PORTABROCAS

14841 2,58€

0.05	50	250	-
Kg	Sub	Up	Down

- Material: acero 40Cr, superficie arenada
- Longitud: 75mm
- Diámetro: 10mm



60023



PARA ALBAÑILERÍA

ACERO 40CR

PORTABROCAS DE ROSCA 2-13MM DE 1/2"-20UNF

14842 9,50€

0.26	5	50	-
Kg	Sub	Up	Down

- Tipo: sin llave.
- Capacidad: 2-13mm.
- Montaje: 1/2"-20UNF.
- Material: Acero.
- Longitud: 6cm.
- Diámetro: 4cm.



60023

ESTUCHES DE BROCAS PARA ALBAÑILERÍA

- Material: puntas de aleación de acero YG8, cuerpo de acero al carbono.
- Para albañilería: piedra, ladrillo, pared, hormigón, cemento, etc.

3-10MM

53861 5,45€

0.20	5	50	950
Kg	Sub	Up	Down

3x60, 4x75, 5x80, 6x100, 7x100, 8x120, 9x120, 10x120mm



53861



DESPIECE DISPONIBLE

4-10MM

53860 3,65€

0.15	5	50	950
Kg	Sub	Up	Down

4x75, 5x80, 6x100, 8x120, 10x120mm



53860



DESPIECE DISPONIBLE

5 PCS



ACERO YG8



PARA ALBAÑILERÍA

60006

DESPIECE DISPONIBLE

REF.	mm	Kg	Sub	Up	Down	€
14907	Ø 3x60mm	0,01	50	100		0,50€
14908	Ø 4x75mm	0,01	50	100		0,60€
14909	Ø 5x80mm	0,01	50	100		0,80€
14910	Ø 6x100mm	0,01	50	100		1,00€
14911	Ø 7x100mm	0,01	50	100		1,30€
14912	Ø 8x120mm	0,05	50	100		1,55€
14913	Ø 9x120mm	0,05	50	100		1,90€
14914	Ø 10x120mm	0,04	20	100		2,10€

TAMBIÉN TE PUEDE INTERESAR...

REF.	mm	Kg	Sub	Up	Down	€
14915	Ø 11x150mm	0,05	20	100		2,65€
14916	Ø 12x150mm	0,06	20	100		2,95€
14917	Ø 13x150mm	0,10	20	100		3,45€

ESTUCHE DE BROCAS HELICOIDALES HSS-G 4341

- Material: HSS-G 4341.
- Para metales: acero inoxidable, hierro, cobre, aluminio, etc.

1-10MM

53852 207,00€

4.20 - 4 192



170
PCS

1x34, 1.5x40, 2x49, 2.5x57, 3x61, 3.5x70, 4x75, 4.5x80, 5x86, 5.5x93, 6x93, 6.5x101, 7x109, 7.5x109, 8x117, 8.5x117, 9x125, 9.5x125, 10x133mm

- Incluye 170 brocas:
- 1.0 - 8.0mm x 10 brocas (incrementos de 0.5mm).
- 8.5 - 10mm x 5 brocas (incrementos de 0.5mm).



DESPIECE DISPONIBLE



HSS-G
4341



PARA METALES

60006



DESPIECE DISPONIBLE

1-13MM

53856 62,00€

1.32 5 10 550



25
PCS

1x34, 1.5x40, 2x49, 2.5x57, 3x61, 3.5x70, 4x75, 4.5x80, 5x86, 5.5x93, 6x93, 6.5x101, 7x109, 7.5x109, 8x117, 8.5x117, 9x125, 9.5x125, 10x133, 10.5x133, 11x142, 11.5x142, 12x151, 12.5x151, 13x151mm



DESPIECE DISPONIBLE



1-10MM

53854 27,00€

0.63 5 20 192



19
PCS

1x34, 1.5x40, 2x49, 2.5x57, 3x61, 3.5x70, 4x75, 4.5x80, 5x86, 5.5x93, 6x93, 6.5x101, 7x109, 7.5x109, 8x117, 8.5x117, 9x125, 9.5x125, 10x133mm



DESPIECE DISPONIBLE



ESTUCHE DE BROCAS HELICOIDALES HSS-R 4241 (NEGRO)

- Material: HSS-R 4241 NEGRO.
- Para metales: acero inoxidable, hierro, cobre, aluminio, etc.

1-10MM

53851 88,00€

3.80 - 4 192



170
PCS

1x34, 1.5x40, 2x49, 2.5x57, 3x61, 3.5x70, 4x75, 4.5x80, 5x86, 5.5x93, 6x93, 6.5x101, 7x109, 7.5x109, 8x117, 8.5x117, 9x125, 9.5x125, 10x133mm

- Incluye 170 brocas:
- 1.0 - 8.0mm x 10 brocas (incrementos de 0.5mm).
- 8.5 - 10mm x 5 brocas (incrementos de 0.5mm).



DESPIECE DISPONIBLE



HSS-R
4241



PARA METALES

60006



DESPIECE DISPONIBLE

1-13MM

53855 24,80€

1.19 5 10 192



25
PCS

1x34, 1.5x40, 2x49, 2.5x57, 3x61, 3.5x70, 4x75, 4.5x80, 5x86, 5.5x93, 6x93, 6.5x101, 7x109, 7.5x109, 8x117, 8.5x117, 9x125, 9.5x125, 10x133, 10.5x133, 11x142, 11.5x142, 12x151, 12.5x151, 13x151mm



DESPIECE DISPONIBLE



1-10MM

53853 14,40€

0.58 5 20 192



19
PCS

1x34, 1.5x40, 2x49, 2.5x57, 3x61, 3.5x70, 4x75, 4.5x80, 5x86, 5.5x93, 6x93, 6.5x101, 7x109, 7.5x109, 8x117, 8.5x117, 9x125, 9.5x125, 10x133mm



DESPIECE DISPONIBLE



REF.	mm	Kg	Sub	11	€
14843	Ø 1x34mm	0,01	50	400	0,50€
14844	Ø 1.5x40mm	0,01	50	400	0,50€
14845	Ø 2x49mm	0,01	50	400	0,50€
14846	Ø 2.5x57mm	0,01	50	400	0,50€
14847	Ø 3x61mm	0,01	50	400	0,50€
14848	Ø 3.5x70mm	0,01	50	400	0,50€
14849	Ø 4x75mm	0,01	50	400	1,00€
14850	Ø 4.5x80mm	0,01	50	400	1,00€
14851	Ø 5x86mm	0,01	50	300	1,00€
14852	Ø 5.5x93mm	0,02	50	300	1,00€
14853	Ø 6x93mm	0,02	25	400	1,00€
14854	Ø 6.5x101mm	0,02	25	400	1,00€
14855	Ø 7x109mm	0,03	25	400	1,00€
14856	Ø 7.5x109mm	0,03	25	400	1,00€
14857	Ø 8x117mm	0,03	25	400	1,50€
14858	Ø 8.5x117mm	0,04	25	400	1,50€
14859	Ø 9x125mm	0,04	25	400	1,50€
14860	Ø 9.5x125mm	0,05	25	400	2,00€
14861	Ø 10x133mm	0,06	25	400	2,00€
14862	Ø 10.5x133mm	0,07	25	400	2,00€
14863	Ø 11x142mm	0,07	25	400	2,50€
14864	Ø 11.5x142mm	0,07	25	400	2,50€
14865	Ø 12x151mm	0,08	25	300	2,50€
14866	Ø 12.5x151mm	0,09	25	200	3,00€
14867	Ø 13x151mm	0,09	25	200	3,00€

ESTUCHE DE PUNTAS CON ADAPTADOR RÁPIDO S2

53857 27,00€

0,40	6	24	1152

- Material: acero S2, óxido negro con ribete, DIN estándar.

- Incluye:

49 puntas de impacto de 25mm:

PH1x3, PH2x3, PH3x3
PZ1x3, PZ2x3, PZ3x3
SL4x2, SL5x2, SL6x2
H:3,4,5

T:10x2, 15x2, 20x2, 25x2, 27x2, 30x2, 40x2

T INVOLABLE: 10, 15, 20, 25, 27, 30, 40

7 puntas de impacto de 65mm con ribete: PH2, PH3, PZ1, PZ2, T20, T25, SL6

1 adaptador de mandril de liberación rápida de 60mm.

60005/60006

ACERO S2 49 PCS



ESTUCHE DE PUNTAS CON ADAPTADORES S2

53858 28,80€

0,55	6	24	672

- Material: acero S2, óxido negro con ribete.

- Incluye 21 puntas de impacto de 25mm:

4x PH:1,2,2,3

3x PZ:1,2,3

4x H:3,4,5,6

4x SL:3,4,5,6

6x T:10,15,20, 25, 30, 40

6x puntas de impacto de 75mm: T15, T20, T25, PH2, PZ2, SL5

1x barra de extensión de 80mm

1x adaptador de mandril de liberación rápida de 60mm

4x llaves de tuercas de 50mm: 6,7,8,10mm

60005/60006

ACERO S2 33 PCS



EN EXPOSITOR DE 6 UNIDADES



EN EXPOSITOR DE 6 UNIDADES

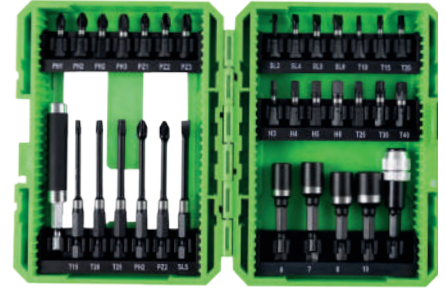

SET DE CLAVOS BRAD DE CALIBRE 18

60037

REF.	DESCRIPCIÓN	Kg	11	€
53999	25x1.25mm	0,20	50	2,00€
54000	30x1.25mm	0,24	50	2,50€
54002	38x1.25mm	0,29	50	3,00€

1000 PCS

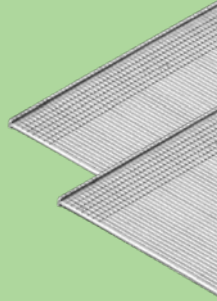
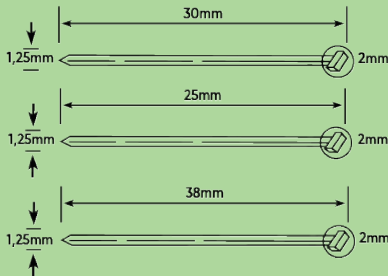

SET DE GRAPAS DE CALIBRE 18

60037

REF.	DESCRIPCIÓN	Kg	11	€
54008	25x6mm	0,43	40	3,50€
54010	32x6mm	0,47	40	4,50€
54011	38x6mm	0,63	40	5,00€

1000 PCS

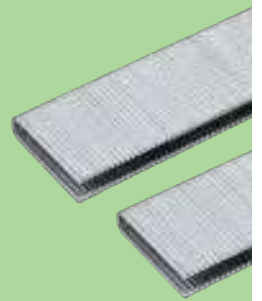
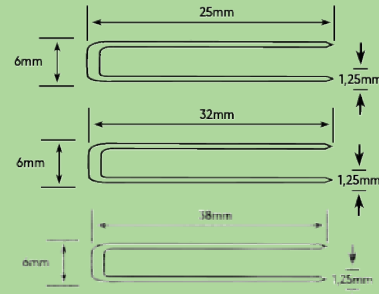

ESTUCHE DE SIERRAS DE CORONA BIMETÁLICAS CON ADAPTADORES

53859 67,00€

1,35	5	10	140

- Para cortar metal y acero inoxidable.

- Material de las sierras:

Puntas: Bimetal HSS M42, 4-6TPI.

Cuerpo: Acero al carbono.

- Material husillos: Bimetal HSS.



60006

HSS M42 4-6TPI 8 PCS



PARA METALES Y ACERO INOXIDABLE

DESPIECE DISPONIBLE

REF.	mm	Kg	11	€
14901	Sierra 22mm	0,04	10 50	3,60€
14902	Sierra 29mm	0,08	10 50	4,65€
14903	Sierra 35mm	0,10	10 50	5,25€
14904	Sierra 44mm	0,12	10 50	6,85€
14905	Sierra 51mm	0,12	10 50	8,50€
14906	Sierra 68mm	0,19	10 50	10,20€
14934	Husillo 14-30mm	0,07	10 50	4,25€
14935	Husillo 32-152mm	0,2	10 50	8,45€



	x6	22, 29, 35, 44, 51, 68mm
	x2	14-30mm, 32-152mm



IVA no incluido

JBM / www.jbmcamp.com

111

PARA METAL (ACERO INOXIDABLE, ALUMINIO, COBRE)

PARA	REF.	DESCRIPCIÓN	Kg	Paquete	€
60011	14989	Hoja de sierra circular 24T 115mm	0,08	- 20 100	6,00€
60007	14988	Hoja de sierra circular 24T 165mm	0,19	- 20 40	8,00€
60022	14990	Hoja de sierra circular 40T 185mm	0,26	- 20 40	10,50€
60019	14995	Hojas de sierra de sable 150mm 24TPI	0,01	2 20 200	8,00€
60010	14993	Hojas de sierra de calar T118A	0,01	5 20 200	5,00€

PARA MADERA

PARA	REF.	DESCRIPCIÓN	Kg	Paquete	€
60011	14986	Hoja de sierra circular 24T 115mm	0,07	- 20 100	4,00€
60007	14985	Hoja de sierra circular 24T 165mm	0,18	- 20 40	6,00€
60022	14987	Hoja de sierra circular 40T 185mm	0,24	- 20 40	8,50€
60019	14994	Hojas de sierra de sable 150mm 6TPI	0,01	2 20 200	3,50€
60010	14991	Hojas de sierra de calar T244D	0,01	5 20 200	2,00

14989 14986



- Material: puntas YG8, cuerpo de carburo de tungsteno.

14988 14985



- Material: puntas YG8, cuerpo de carburo de tungsteno

14990 14987



- Material: puntas YG8, cuerpo de carburo de tungsteno

14995



- Material: acero HSS.

14993



- Material: acero HSS.

14994



- Material: acero con alto contenido en carbono.

14991



- Material: acero con alto contenido en carbono.

DISCOS DE CORTE

- Material: alúmina monocristalina fundida SA 50% / Alúmina fundida blanca 50%.

PARA METAL

REF.	DESCRIPCIÓN	Kg	Paquete	€
14893	T42 - 115x2.5mm	0,05	50 100	2,00€
14894	T42 - 125x2.5mm	0,70	50 100	1,20€
14895	T27 - 115x6mm	0,15	25 100	1,90€
14896	T27 - 125x6mm	0,78	25 100	2,10€



PARA ACERO INOXIDABLE

REF.	DESCRIPCIÓN	Kg	Paquete	€
14897	T41 - 115x1mm	0,01	50 400	0,88€
14898	T41 - 125x1mm	0,03	50 400	0,98€
14899	T41 - 115x1.6mm	0,03	50 400	0,88€
14900	T41 - 125x1.6mm	0,04	50 400	0,98€



PARA METALES Y ACERO INOXIDABLE

60008/60023

14893 T42



14895 T27



14897 T41



14898 T41



14894 T42



14896 T27



14899 T421



14900 T41



TUERCA DE SUJECIÓN RÁPIDA M14 PARA AMOLADORA ANGULAR

15014 20,00€

Kg	Paquete	€
0.10	50 100	-



60008/60023





ILUMINACIÓN

- 114 PORTÁTILES DE TALLER
- 118 PORTÁTILES DE LUZ FRONTAL
- 119 LUPAS LED / LINTERNAS
- 120 FOCOS LED
 - / ALINEADORES DE FAROS
 - / TOMAS DE MECHERO Y TRANSFORMADORES
- 121 BARRAS LED
- 122 LÁMPARA LED INDUSTRIAL
- 122 GIROFAROS
- 125 AVISADORES ACÚSTICOS
- 126 FAROS DE TRABAJO
- 127 PARA REMOLQUE
- 129 BOMBILLAS TURISMO

PORTÁTIL DE TALLER COB 400LM

53734 23,70€

0.25 20 60 1260



BASE ROTATIVA 360° IMANTADA



380mm

32mm



potente luz LED : de 30Lm a 400Lm



SELECTOR DE INTENSIDAD DE LUZ



CON COLGADOR



CARGADOR USB



EN EXPOSITOR DE 20 UNIDADES

PORTÁTIL DE TALLER COB EXTRAFINO

53519 42,00€

0.20 12 72 720



EN EXPOSITOR DE 12 UNIDADES



EXTRAFINO



12mm

300mm

38mm

LÁMPARA PORTÁTIL SLIM LED COB ARTICULADA CON BATERÍA RECARGABLE

52536 57,00€

0.40 - 10 320



360mm

50mm



PORTÁTIL DE TALLER CON BASE IMANTADA ARTICULADA

54122 38,00€

0.39 Kg 12 SUB 24 384

6500±400 KELVIN

300 Lm

3-4H

100V 240V USB 5V 1A

LED 3W COB 2.5H

LED 3W 7H

3.7V 20Ah

IP 44

INCLUDE

257mm

50mm

26mm

54123 40,00€

0.39 Kg 12 SUB 24 384

6500±400 KELVIN

500 Lm

6-7H

100V 240V USB 5V 1A

LED 5W COB 3H

LED 3W 14H

3.7V 40Ah

IP 44

INCLUDE

54124 47,00€

0.39 Kg 12 SUB 24 432

6500±400 KELVIN

1000 Lm

6-8H

100V 240V USB 5V 1A

LED 10W COB 3H

LED 3W 14H

LM1000 900 700

5 min 30 min 145 min

3.7V 40Ah

IP 44

INCLUDE

EN EXPOSITOR DE 12 UNIDADES

ADAPTADOR USB PARA ENCHUFE DE PARED

14031 7,90€

0.10 Kg 10 SUB 100 1152

PORTÁTIL DE TALLER 24+6 LEDS CON BATERÍA RECARGABLE

51889 49,00€

0.43 Kg 10 SUB 360

255mm

56mm

60 Lm

x24+6 LED

3-4H

4-5H

LITIO 3.7V 1400MAH

DOBLE GANCHO Y DOBLE IMÁN

LINTERNA SUPERIOR 6 LEDS

10H. AUTONOMÍA

LÁMPARA PORTÁTIL COB PLEGABLE CON BASE GIRATORIA IMANTADA ARTICULADA

53216 49,00€

0.60 Kg 10 SUB 120

200 Lm

LED 7W COB

3-4H

3.7V 2000MAH

4H

5V 1000MA

390mm

100mm

180mm

IVA no incluido

LÁMPARA DE BOLSILLO CON BATERÍA

53776 19,10€

0,15 12 48 1920



3 MODOS DE LUZ

90-250 Lm 2,5H

3,5-6H 3,7V 1500MAH

ABS



EN EXPOSITOR DE 12 UNIDADES



LÁMPARA DE BOLSILLO CON BATERÍA

52987 20,00€

0,17 10 40 720



EN EXPOSITOR DE 10 UNIDADES



LÁMPARA LED COB CON BASE ARTICULADA

52883 38,00€

0,31 - 20 640



LÁMPARA PORTÁTIL COB ULTRAVIOLETA FLEXIBLE CON BASE IMANTADA

53530 46,00€

0,35 - 20 620



5V 1A

3,7V 2.2AH LED 2W COB

4H 4H

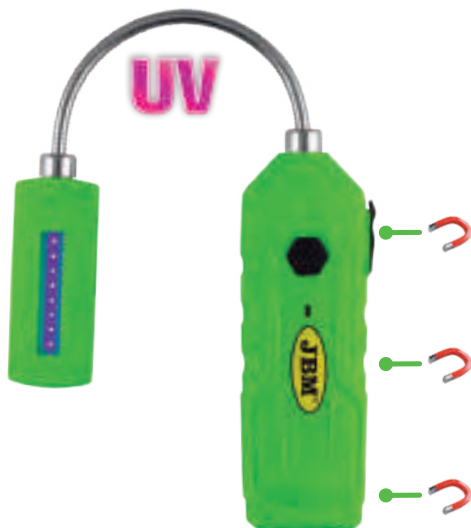

LÁMPARA PORTÁTIL COB FLEXIBLE CON BASE IMANTADA

53217 47,00€

0,30 - 20 620



200 Lm LED 2W COB

3,7V 2600MAH 5V 1.000MAH 4H



FARO DE TRABAJO RECARGABLE

53974 38,00€

0.75 5 20 240



¿Quieres ver cómo funciona?



4 MODOS DE LUZ

100% 50% SOS FLASH



MULTIPOSICIÓN



LÁMPARA LED DE TALLER 400LM

53780 14,50€

0.45 5 20 280



CABLE DE ALIMENTACIÓN DE 2,5M

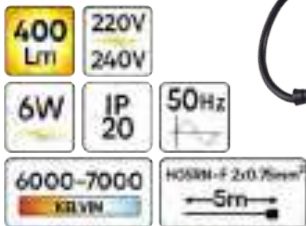

INCLUYE GANCHO SUPERIOR PARA PODER TRABAJAR CÓMODAMENTE

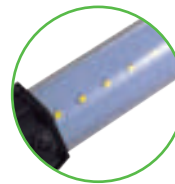

POTENTE LUZ PERFECTA PARA ILUMINAR LA ZONA DE TRABAJO

PORTÁTIL EXTRAPLANO CON LED COB

52384 29,00€

0.33 - 20 600



- Longitud del cable: 5m
- DC Longitud del cable: 0,1m
- DC longitud del cable de la pinza: 0,3m

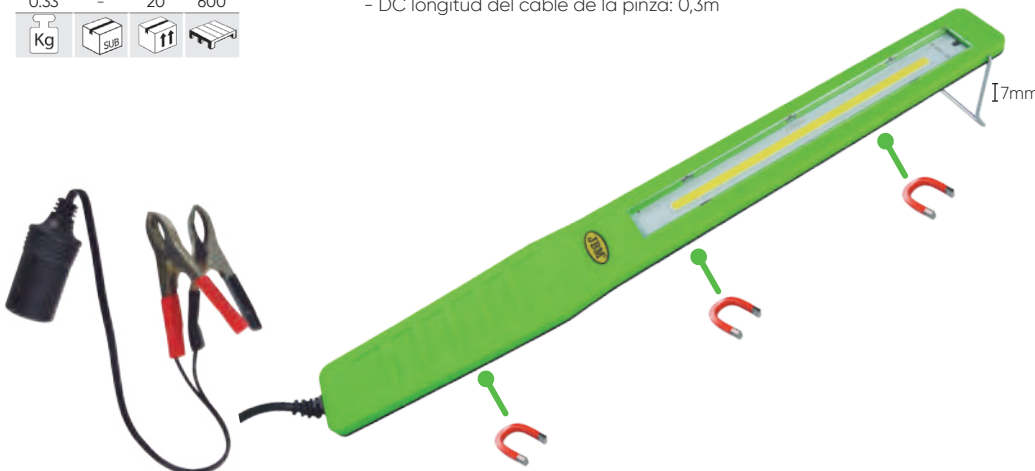

IVA no incluido

LÁMPARAS PORTÁTILES

PORTÁTIL DE LUZ FRONTAL COB

54004 23,00€

0.10 12 96 2592



COB + LED 350LM

350Lm 150Lm



150Lm 60Lm



BOTÓN SENSOR DE MOVIMIENTO



Pulsar para activar/desactivar.
Pasar la mano por delante del botón para encender y apagar la luz.

- Material: Gel de sílice.
- Indicador de encendido, indicador de inducción.
- Modo de activación por sensor de movimiento.
- Cable de carga USB incluido.



GUANTE CON LUZ LED

54267 9,50€

0.05 10 60 2640



LED



LED

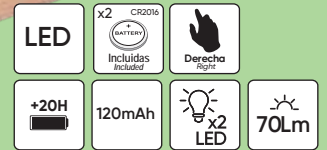

PORTÁTIL DE LUZ FRONTAL CREE + COB 800LM

53569 18,00€

0.30 10 50 400



CREE + COB 800LM



BATERÍAS RECARGABLES

REGULADOR DE ENFOQUE

INDICADOR DE LUZ ENCENDIDA



3 MODOS DE LUZ



90°



PORTÁTIL DE LUZ FRONTAL 350LM

53568 12,00€

0.20 10 100 400



350LM



REGULADOR DE ENFOQUE



3 MODOS DE LUZ



LÁMPARAS PORTÁTILES

LUPA LED DE MESA

53227 28,00€

0.60	6	24	192

- Hasta 500 ciclos de carga.
- LED de luz blanca, grandes ahorros.
- Vida extendida y alta luminosidad.



LUPA DE 8 LEDS (5x)

53085 30,00€

0.31	10	40	1500



- Incluye:
- Paño limpialupa
 - Funda antigolpes

LINTERNA PLÁSTICA 9 LEDS

52555 2,38€

0.03	48	192	3456

52558 2,38€

0.03	48	192	3072

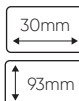

EN EXPOSITOR DE 12 UNIDADES

MINI LINTERNA IMANTADA

53427 5,00€

0.05	12	96	3456



EN EXPOSITOR DE 12 UNIDADES

LINTERNA DE 21 LEDS

51326 4,40€

0.07	12	144	2880



EN EXPOSITOR DE 12 UNIDADES

- Artículo Auxiliar.
- 21 Led's de larga duración.

LINTERNA DINAMO DE 2 LEDS

51573 2,50€

0.07	12	96	3456



PRESENTACIÓN EN CAJA INDIVIDUAL

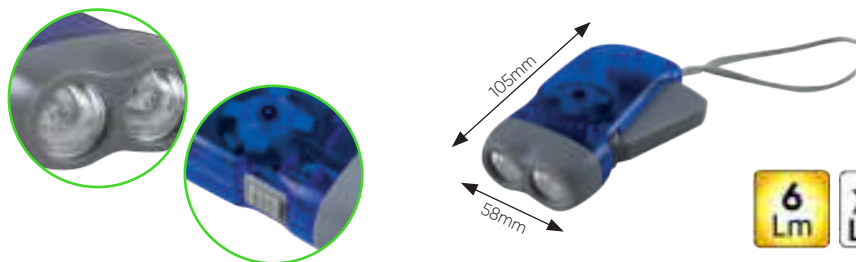

PILAS DE RECAMBIO

"AAA" R03 1,5V

51258 0,15€

0.01	60	2400	134400



x3

PARA REF. 51325, 51326, 51829, 52233, 51001, 52582, 52555, 52556, 52557, 52558, 52584

PILA CUADRADA 9V

10923 1,10€

0.05	10	500	-



PARA REF. 52162, 52450, 51929, 50942

FOCO LED DE 50W

53505 77,00€

2.50 - 8 96
Kg SUB IT



TRÍPODE PARA FOCO LED REF. 53505

53506 36,00€

2.40 - 8 96
Kg SUB IT



TRÍPODE PARA LÁMPARA DE INSPECCIÓN REF. 52232

52254 64,00€

3.51 - 4 24
Kg SUB IT



- Lámpara no incluida.

↑ 2.770mm
↓ 1.290mm

ALINEADOR DE FAROS CON LUXÓMETRO

52740 690,00€

24.00 - 1 11
Kg SUB IT

HALÓGENO / XENON / LED

- Distancia de medición: 50cm.
- Fácil medición de la desviación del eje óptico de la luz de carretera y de la luz de cruce.
- También para camiones.



CE

ALINEADOR DE FAROS DOBLE LASER CON LUXÓMETRO

52836 1.100,00€

24.85 - 1 10
Kg SUB IT

HALÓGENO / XENON / LED
REGULACIÓN PANTALLA DE VERIFICACIÓN

LUXÓMETRO DIGITAL

- También para camiones.



DOBLE LÁSER

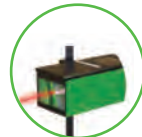

270mm
520mm
1560mm

CE

TOMAS DE MECHERO Y TRANSFORMADORES

REF.	DESCRIPCIÓN	PARA	Kg	Sub	IT	€
11107	TOMA DE MECHERO ENTRADA: 100-240V SALIDA: 6V 500mA	54122, 54123, 54124, 51889, 52883, 53568	0,06	1	250	4,50€
10961	TRANSFORMADOR DE CORRIENTE ENTRADA: 100-240V SALIDA: 6V 500mA	54122, 54123, 54124, 51889, 52883, 53568, 53569	0,08	-	150	13,00€
11989	TOMA DE MECHERO ENTRADA: 100-240V SALIDA: 9V 500mA	52536	0,04	-	200	2,00€
11093	TOMA DE MECHERO ENTRADA: 230V SALIDA: 6V 500mA	52002	0,06	-	250	4,00€
14031	ADAPTADOR USB PARA ENCHUFE DE PARED ENTRADA: 100-240V SALIDA: 5V 1000mA	54122, 54123, 54124, 53216, 53217, 53519, 52987, 52883, 53530, 53451, 53570, 53707, 53439, 53568, 53569	0,1	10	100	7,90€
13839	ADAPTADOR USB PARA ENCHUFE DE PARED 110V/60HZ	54122, 54123, 54124, 54216, 53217, 53519, 2987, 52883, 53530, 53451, 53570, 53707, 53439, 53568,	0,04	-	200	8,50€
14032	ADAPTADOR USB PARA TOMA DE MECHERO ENTRADA: 12-24V SALIDA: 5V, 1A/2,1A	53465, 53466, 53467, 53216, 53217, 53519, 52987, 52883, 53530, 53451, 53570, 53707, 53439, 53568, 53569	0,1	10	100	12,00€
14033	CABLE USB LONGITUD: 80CM	53216, 53217, 53519, 52987, 53530, 53451, 53570, 53707, 53499	0,1	10	100	4,50€
16052	CABLE USB TIPO A / CLAVIJA REDONDA 3,5MM	54172, 54173	0,1	10	100	2,09€
16053	CABLE USB TIPO A / CLAVIJA REDONDA 5,5MM	54173	0,1	10	100	2,85€



BARRA LED IMANTADA

54270 42,00€

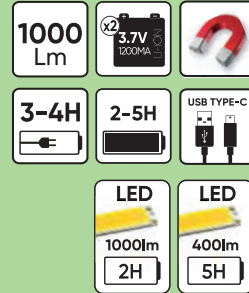
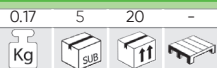

BARRA LED IMANTADA CON CINTA PARA CAPÓ

54271 54,00€

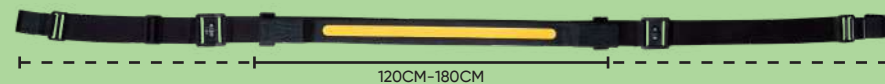
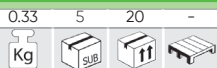

120CM-180CM

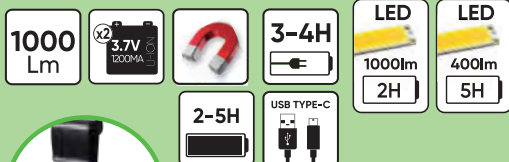

BARRA LED IMANTADA

53707 153,00€



3 LEDS
1000LM

MULTIUSO

CON SOPORTE MAGNÉTICO PARA ADAPTARSE A CUALQUIER SITUACIÓN

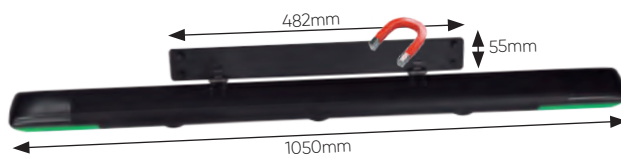

3 MODOS DE LUZ

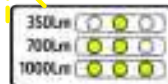

PERMITE DIRIGIR EL FOCO DE LUZ INDIVIDUALMENTE DONDE SE PRECISE



360°

LUCES INDICADORAS DEL ESTADO DE LA BATERÍA

BATERÍA RECARGABLE



AUMENTAN NOTABLEMENTE LA VISIBILIDAD EN LA ZONA DE TRABAJO.

BARRA LED PARA CAPÓ CON BRAZOS EXTENSIBLES

53570 154,00€



3 LEDS
1000LM

3 MODOS DE LUZ

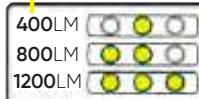

BRAZOS EXTENSIBLES DE 1170MM A 1750MM



PERMITE DIRIGIR EL FOCO DE LUZ INDIVIDUALMENTE DONDE SE PRECISE



360°

LUCES INDICADORAS DEL ESTADO DE LA BATERÍA

BATERÍA RECARGABLE



AUMENTAN NOTABLEMENTE LA VISIBILIDAD EN LA ZONA DE TRABAJO



IVA no incluido

JBM / www.jbmcamp.com

121

LÁMPARAS PORTÁTILES

LÁMPARA LED INDUSTRIAL

54039 154,00€

Ø :50cm x 38cm

2.60 - 1 14



Este artículo está especialmente diseñado para la iluminación de ambientes industriales, talleres y espacios de gran altura.

- Peso ligero
- Potencia: 200W
- Flujo luminoso: 20000Lm
- Diámetro: 50cm x 38cm

- Grado de protección: IP20
- LED: MTC
- Driver: Meanwell
- Temperatura de color: 6500k
- Frecuencia: 50/ 60 Hz



20.000Lm



RECAMBIO CAMPANAS

15385 18,00€



CONJUNTO DE 6 LÁMPARAS LED INDUSTRIALES

54133 547,00€

12.10 - 6 6

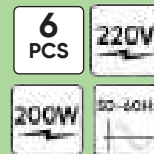

20.000Lm

LÁMPARA LED UFO INDUSTRIAL

54088 132,00€

Ø :29,9cm x 14,7cm

2.50 - 1 63

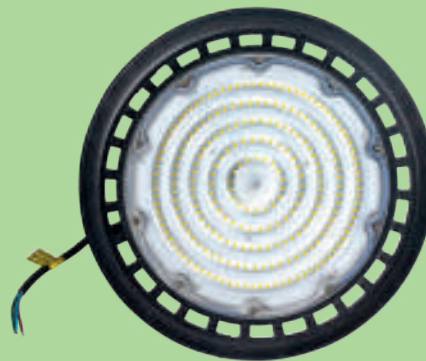

GIROFARO LED MAGNÉTICO

53691 36,00€

0.70 - 20 320



- Funciones:
Función 1: DESTELLO
Función 2: DOBLE DESTELLO
Función 3: ROTACIÓN



ECE R65 ECE R10

GIROFARO LED 12-24V BASE FLEXIBLE

53690 34,00€

0.55 - 20 200



- Funciones:
Función 1: DESTELLO
Función 2: DOBLE DESTELLO
Función 3: ROTACIÓN

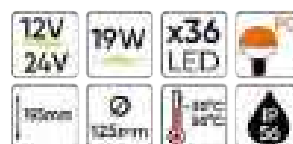

ECE R10
ECE R65



GIROFARO LED RECARGABLE 9-30V IMANTADO

54173 87,00€

0,75	5	20	240
Kg	Sub	ff	

- Funciones:
- Función 1: DESTELLO
- Función 2: DOBLE DESTELLO
- Función 3: ROTACIÓN

CABLE USB TIPO A / CLAVIJA REDONDA 5.5MM

16053 2,85€



Alimentado a batería recargable
Rechargeable battery powered.



Homologado ECE R10/R65

GIROFARO LED RECARGABLE 9-30V BASE FLEXIBLE

54172 81,00€

0,80	5	20	240
Kg	Sub	ff	

- Funciones:
- Función 1: DESTELLO
- Función 2: DOBLE DESTELLO
- Función 3: ROTACIÓN

CABLE USB TIPO A / CLAVIJA REDONDA 3.5MM

16052 2,09€



Alimentado a batería recargable
Rechargeable battery powered.



Homologado ECE R10/R65

GIROFARO LED BASE FLEXIBLE

52456 36,00€

0,60	-	20	160
Kg	Sub	ff	

- Lente PC.
- Tulipa anti-rotura.
- Consumo: 8W.

- Funciones:
- Función 1: ROTACIÓN
- Función 2: DOBLE DESTELLO
- Función 3: 6 DESTELLOS

LED 6 EN 1



ABS - BAES



Ø 24mm

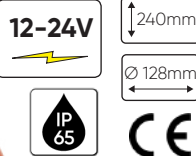

ECE R10

GIROFARO DESTELLANTE DE LED

52375 38,00€

0,70	-	20	240
Kg	Sub	ff	

- Lente ABS-BAES.
- Tulipa anti-rotura.
- Cable: Espiral de 2,5m + toma mechero.
- Consumo: 9W.

- Funciones:
- Función 1: ROTACIÓN
- Función 2: DOBLE DESTELLO
- Función 3: 6 DESTELLOS

LED 6 EN 1



ECE R10

GIROFARO BASE FLEXIBLE

51964 28,00€

0,65	-	20	160
Kg	Sub	ff	

12V
55W

51965 29,50€

0,68	-	20	160
Kg	Sub	ff	

24V
70W

ECE R10
ECE R65
PC

- Lente PC.
- Tulipas anti-rotura
- Hilo de la lente con sellado duradero.
- Rpm: 40.
- Sistema de piñón / Sinfin.
- Bombilla:
- H1, 12V 55W
- H1, 24V 70W
- Con base de rosca.
- Consumo corriente: 3.0 A.

BASE FLEXIBLE



ABS - BAES

GIROFARO SIN CABLE

51962 25,00€

0,57	-	20	240
Kg	Sub	ff	

12V
55W

51963 29,00€

0,55	-	20	240
Kg	Sub	ff	

24V
70W

ECE R10
ECE R65

- Lente ABS - BAES.
- Tulipas anti-rotura.
- Hilo de la lente con sellado duradero.
- Rpm: 40.
- Sistema de piñón / Sinfin.
- Bombilla:
- H1, 12V 55W
- H1, 24V 70W
- Consumo corriente: 3.0 A.



GIROFARO CON CABLE IMANTADO

51960 34,00€

0.75 - 20 240



12V
55W



170mm
Ø 140mm

51961 34,00€

0.78 - 20 240



24V
70W



- Lente ABS - BAES.
- Tulipas anti-rotura.
- Hilo de la lente con sellado duradero.
- Rpm: 40.
- Sistema de piñón / Sinfin.
- Bombilla: H1, 12V 55W
- Cable: Espiral de 3m + toma de mechero.
- Consumo corriente: 3.0 A.

ECE R10
ECE R65 CE

FARO DESTELLANTE

51966 18,00€

0.31 - 50 800



12V
110V

131mm
Ø 99mm
Ø 61mm

- Lente ABS - BAES.
- XENON.
- Consumo corriente: 3.0 A.

BASE TULIPA
ROSCADA



ECE R10
CE

GIROFARO DESTELLANTE ROTATIVO LED PERFIL BAJO

52827 46,00€

0.50 - 20 400



52910 39,00€

0.50 - 20 320



52828 43,00€

0.54 - 20 320



CE ECE R10

- Con 3 interruptores de función.
- 3 modos intermitentes: ROTATIVO 6 DESTELLOS MODO DUAL FLASH



CAPARAZÓN DE GIROFARO PARA REF. 51960, 51962, 51964

PARA REF. 51966

11103 6,00€

0.01 - 100 -



PARA REF. 51960, 51962, 51964

10766 1,59€

0.01 - 200 -



TULIPAS ANTI-ROTURA

51969 14,00€

0.12 - 50 1000



120mm
Ø 128mm

11325 17,50€

0.12 - 50 451



11324 17,50€

0.13 - 100 -



CONECTORES DE ASTA PARA GIROFARO

PARA REF. 51964, 51965, 52300, 52456, 52549, 53131

10750 13,00€

0.25 - 50 -



PARA REF. 51964, 51965, 52300, 52456, 52549, 53131

10751 15,00€

0.30 - 50 -



BARRA EXTENSIBLE PARA GIROFARO

52843 31,60€

0.90 - 20 1500

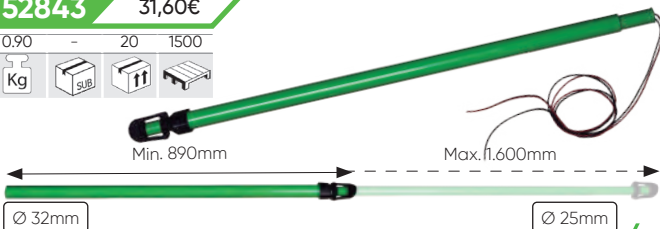

124

JBM www.jbmcamp.com

IVA no incluido

AVISADOR ACÚSTICO 12V - 80V

51967 16,00€

0,20	10	50	1200
Kg	Sub	ff	ff



12V 80V | 12V 80V | 107 dBa | -30°C 70°C | IP 65

51968 16,00€

0,23	10	50	1000
Kg	Sub	ff	ff

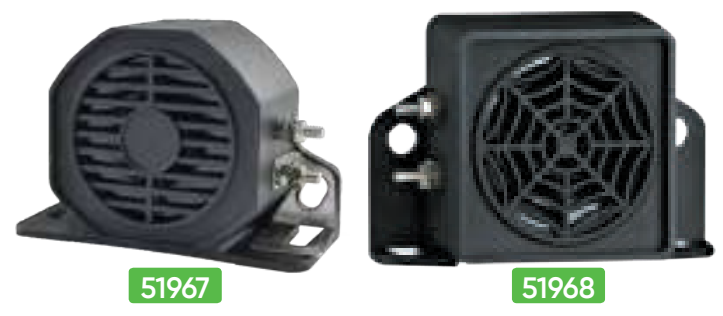

- 107 dB.
- Resistente a distintas condiciones climáticas.
- Posibilidad de lavarlo con agua a presión.

- Protegido frente a polaridades inversas.
- Sellado con resinas epoxy.
- Temperaturas soportadas: de -30 a 70°C.

LUZ DE SEGURIDAD PARA CARRETILLA ELEVADORA

54078 68,00€

0,66	-	20	200
Kg	Sub	ff	ff

10V 60V | 15W



Luz oval de seguridad con 2 leds azules. Se proyecta sobre el terreno con una luz concentrada azul a modo de advertencia para los peatones de la zona.

Esta luz de alerta permite evitar colisiones y accidentes entre carretillas elevadoras y personas, y aumenta la seguridad en el entorno de trabajo, especialmente en puntos ciegos. Perfecto para ambientes ruidosos.

Soporte universal

FARO DE TRABAJO LED LUZ DISPERSA

53428 18,00€

0,50	5	20	480
Kg	Sub	ff	ff

1.800 Lm | 10V 30V | x9 LED 27W | LED | IP 67 | 6000 KELVIN | AL

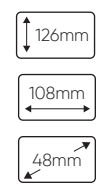

52566 28,00€

1,00	-	10	360
Kg	Sub	ff	ff

1.450 Lm | 10V 40V | x9 LED 3W | LED | IP 68 | 30.000h | AL

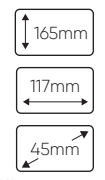

53429 18,00€

0,40	5	20	480
Kg	Sub	ff	ff

1.800 Lm | 10V 30V | x9 LED 27W | LED | IP 67 | 6000 KELVIN | AL



52567 29,00€

0,90	-	10	400
Kg	Sub	ff	ff

1.450 Lm | 10V 40V | x9 LED 3W | LED | IP 68 | 30.000h | AL

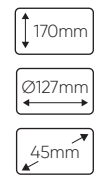

52302 25,40€

0,80	5	20	480
Kg	Sub	ff	ff

1.450 Lm | 10-40V 27W | x9 LED 3W | LED | IP 68 | 30.000h | AL



53049 89,00€

1,53	-	10	468
Kg	Sub	ff	ff

3.600 Lm | 9-36V 40W | x4 LED 10W | LED | IP 68 | 30.000h | AL

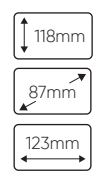

FARO DE TRABAJO LED LUZ DISPERSA

52303 26,40€

0,76 5 20 640



1.450 Lm **x9 LED 3W**

Al **10-40V 27W** **IP 68**



140mm
45mm
Ø123mm

53052 158,00€

2,65 - 6 144



7.200 Lm **x8 LED 10W**

Al **9-36V 80W** **IP 68**



191,5mm
Ø165mm
98mm

53045 35,00€

1,00 - 12 480



2.880 Lm **x16 LED 3W**

Al **9-36V 46W** **IP 68**



55mm
127mm
155mm

53046 39,00€

0,74 - 12 480



2.272 Lm **x16 LED 1,5W**

Al **9-36V 24W** **IP 68**



139mm
128mm
48,5mm

FARO DE TRABAJO LED LUZ CONCENTRADA

52568 28,00€

0,75 - 10 400



1.450 Lm **x9 LED 3W** **10V 40V**

Al **IP 68**

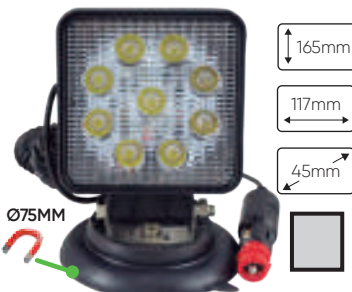

165mm
117mm
45mm

53048 89,00€

1,50 - 10 1000



3.600 Lm **x4 LED 10W**

Al **9-36V 40W** **IP 68**



87mm
123mm
118mm

52569 28,00€

0,70 5 20 320



1.450 Lm **x9 LED 3W** **10V 40V**

Al **IP 68**



170mm
Ø127mm
45mm

53051 158,00€

2,75 - 6 468



7.200 Lm **x8 LED 10W**

Al **9-36V 80W** **IP 68**



191,5mm
Ø165mm
98mm

52415 19,00€

0,60 5 20 480



1.450 Lm **x9 LED 3W**

Al **10V 40V** **IP 68**



128mm
110mm
50mm

53047 330,00€

3,51 - 4 40



3.200 Lm **x10 LED 5W**

Al **12-24V 80W** **IP 67**



230mm
150mm
185mm

52414 19,00€

0,55 5 20 480



1.450 Lm **x9 LED 3W**

Al **10V 40V** **IP 68**



128mm
Ø110mm
50mm



DISTANCIA REMOTA 100M



VELOCIDAD AJUSTABLE DE MOVIMIENTO



GIRATORIO

BARRA PARA REMOLQUE CON 2 PILOTOS LED Y 2 CATAREFLECTANTES

54163 80,00€

1.85 - 6 54

Kg SUB 11

x42 LED 12V 24V 7.5m 7PIN IP 65

140mm 110mm

- 4 funciones:
Posición y matrícula.
Luz de freno.
Intermitente.
Masa.

Luces dinámicas

Reglamento nº	Nº de homologación
3	E9*3R02/17*23444*00
4	E9*4R00/19*23444*00
6	E9*6R01/29*23444*00
7	E9*7R02/27*23444*00
10	E9*10R06/00*22232*02

KIT MAGNÉTICO DE 2 PILOTOS LED Y 2 CATAREFLECTANTES

54162 81,00€

1.50 - 6 144

Kg SUB 11

x42 LED 12V 24V 7.5m 7PIN IP 65

140mm 110mm

- 4 funciones:
Posición y matrícula.
Luz de freno.
Intermitente.
Masa.

Luces dinámicas

Homologado E9*7R02/27*23444*00

93mm 58mm 118mm

BARRA TELESCÓPICA PARA REMOLQUE CON 2 PILOTOS LED Y 2 CATAREFLECTANTES

54161 90,00€

2.75 - 6 48

Kg SUB 11

x42 LED 12V 24V 7.5m 7PIN IP 65

1,4-2,1m

- 4 funciones:
Posición y matrícula.
Luz de freno.
Intermitente.
Masa.

Luces dinámicas

Homologado E9*7R02/27*23444*00

KIT MAGNÉTICO 2 PILOTOS LED INALÁMBRICOS

54044 99,00€

1.15 - 6 168

Kg SUB 11

2.4 GHz -10°C 50°C WIRELESS

2-3H 10H

IP65 20m 12V 24V

7 PINS

Homologado E9*178R00*1448 E9*150R00*1448

Cargador de coche USB

1m Cable de carga

35mm 108mm 98mm

PILOTO LED PARA BARRA DE REMOLQUE

53151 14,00€

0.20 5 20 900

Kg SUB 11

99mm 100mm 12V 39mm

- 4 funciones:
● Azul: Posición y matrícula.
● Rojo: Luz de freno.
● Amarillo: Intermitente.
○ Blanco: Masa.

PILOTO LED IMANTADO PARA BARRA DE REMOLQUE

54160R 17,50€ **54160L** 17,50€

0.20 5 20 880

Kg SUB 11

12V 24V x42 LED

93mm 118mm 93mm 46mm

- 4 funciones:
● Negro: Posición y matrícula.
● Rojo: Luz de freno.
● Verde: Intermitente.
○ Blanco: Masa.

Luces dinámicas

Homologado E9*7R02/27*23444*00

BARRA TELESCÓPICA PARA REMOLQUE

DE 1,4 a 2,1M - 6M CABLE

52458 58,00€

2,60	-	6	48
Kg	Sub	ff	

12V 7 PINS 1.400mm 2.100mm



CATADIOPTICO TRIANGULAR PARA REF.52458, 52848, 52838, 50810, 51886, 52839

16158 9,00€



52848 88,00€

2,49	-	6	36
Kg	Sub	ff	



CATADIOPTICO TRIANGULAR PARA REF.52458, 52848, 52838, 50810, 51886, 52839

16158 9,00€

Homologado E4 7R-0218756



BARRA PARA REMOLQUE CON 2 PILOTOS Y 2 CATAREFLECTANTES TRIANGULARES, CABLE DE 5m

50910 45,00€

1,90	-	6	54
Kg	Sub	ff	

12V 7 PINS LED

Homologado E4 7R-0218756

140mm	1100mm
-------	--------

Material: HDPE

- Funciones:
- Luz de posición
- Luz de matrícula
- Intermitente
- Freno



52838 56,00€

1,85	-	6	54
Kg	Sub	ff	

CATADIOPTICO TRIANGULAR PARA REF.52458, 52848, 52838, 50810, 51886, 52839

16158 9,00€



KITS MAGNÉTICO CON 2 PILOTOS Y 2 CATAREFLECTANTES

51886 44,00€

1,50	-	8	120
Kg	Sub	ff	

Cable liso: 7m
Cable de espiral: 2,5m

52839 64,00€

1,47	-	8	128
Kg	Sub	ff	

Homologado E4-7R-0218756

118mm	123mm	87mm
-------	-------	------

LED

7 PINS 12V



16158 9,00€

CATADIOPTICO TRIANGULAR PARA REF.52458, 52848, 52838, 50810, 51886, 52839



COMPROBADOR DE LUCES DE REMOLQUE 7/13 PINS

53536 34,00€

0,40	4	24	432
Kg	sub	ff	



7-13 pins

9V



ALARGADOR 7 PINS

- Este comprobador tiene una toma de 13 pins en cada extremo para ser conectada al enchufe del remolque y del coche.
- Indica rápidamente si hay daños en el cableado tanto del coche como del remolque.
- También útil para la comprobación de

caravanas y soportes para bicicletas.
- Dispone de dos salidas, una para la toma de salida del vehículo u otra para la toma de entrada del remolque.
- Incluye un adaptador de 13 a 7 pins.
- PILA 9V.



13 PINS



7 PINS



14753 13,00€

0,20	-	50	-
Kg	sub	ff	

- Incluye clavija de 7 pins y enchufe de 7 pins
- Medida cable: 20cm x 0,5mm²

COMPROBADOR DE LUCES DE REMOLQUE 7 PINS

51929 22,00€

0,90	4	24	1144
Kg	sub	ff	

7 pins

9V



- Este comprobador tiene una toma en un costado para conectar el enchufe de 7 polos del remolque y en el otro para conectar el enchufe de 7 polos del vehículo.
- Indica rápidamente si hay daños en el cableado tanto del coche como del remolque.

- También útil para la comprobación de caravanas y soportes para bicicletas.
- Dispone de dos salidas, una para la toma de salida del vehículo y otra para la toma de entrada del remolque.

TOMA REMOLQUE



TOMA VEHÍCULO



MINI ESTUCHE DE BOMBILLAS

12V H9



12V

51615 5,95€

0,09	10	100	1500
Kg	sub	ff	

12V H11



12V

51612 5,95€

0,09	10	100	1500
Kg	sub	ff	

12 V HB3



12V

50523 4,70€

0,09	10	100	1500
Kg	sub	ff	

12V HB4



12V

50524 4,70€

0,09	10	100	1500
Kg	sub	ff	

12V H7+H1



12V

50915 4,20€

0,10	10	100	1800
Kg	sub	ff	

12 V H1



12V

51613 2,90€

0,90	10	100	1500
Kg	sub	ff	

H4



12V

51614 3,60€

0,10	10	100	1800
Kg	sub	ff	

52047 3,30€

0,09	10	100	1500
Kg	sub	ff	

H7



12V

50431 3,80€

0,08	10	100	1800
Kg	sub	ff	

52048 3,95€

0,10	10	100	1500
Kg	sub	ff	

24V

ARMARIO DE BOMBILLAS PARA TURISMO

50551 350,00€

560mm 650mm

9,39 - 1 14
Kg sub if

Stop de 1 Polo

P21W 21 W BA15s 30u.
P21WA 21 W BA15s Ambar / 10u.
PY21W 21 W BAU15s
Con desc. / 10u.

Stop de 2 Polos

R21/5 W 21/5 W BAY15d 40u.
PLAFONIER
C5W 5 W SV8.5 11x38 22u.

Lámparas Piloto

R5W 5 W BA15s 30u.
R10W 10 W BA15s 30u.

Lámparas indicadoras

T4W 4 W BA9s 22u.

Lámparas Halógenas

H1 55 W P14,5s 10u.
H2 55 W X511 4u.
H3 55 W PK22s 4u.
H4 60/55 W P43t 10u.
H7 55 W PX26d 10u.
HB3 65 W P20d 4u.
HB4 55 W P20d 4u.
H9 65 W PGJ19-5 4u.
H11 65 W PGJ19-2 4u.

Foco Europeo

T5 1,2 W W2,1x4,6d 20u.
T10 5 W W2,1x9,6d 12u.
T10 3 W W2,1x9,6d 12u.
T13 10 W W2,1x9,6d 10u.
T15 18 W W2,1x9,6d 10u.
T20 21 W W5x16d 10u.
T20A 21 W W5x16d Ambar 10u.
T20 21/5 W W5x16d 10u.

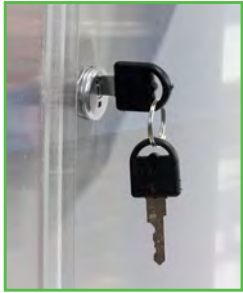

BOMBILLAS OBN

H7	H4	H1	H1 55W	H3	BA15S	2 POLOS
52365 2,46€	52364 2,86€	52362 1,23€	10766 1,59€	52363 1,23€	53203 0,46€	52369 1,19€
0,02 10 200 9000	0,02 10 200 4400	0,01 10 200 14400	0,01 - 200 -	0,02 10 200 14400	0,01 10 200 -	0,01 10 1000 18000
Kg sub if	Kg sub if	Kg sub if	Kg sub if	Kg sub if	Kg sub if	Kg sub if
12V - Empaque: Caja 1pcs	12V - Empaque: Caja 1pcs	12V - Empaque: Caja 1pcs	12V - Empaque: Caja 1pcs	12V - Empaque: Caja 1pcs	12V - Empaque: Caja 1pcs	12V - Empaque: Caja 10pcs
55W	60-55W	55W	55W	55W	21W	21-55W
T20A	R5W	WEDGE T20	T20	T20	T13	T15
52368 1,14€	53007 0,42€	52862 1,15€	52370 1,17€	52864 1,20€	52865 0,50€	52866 0,25€
0,01 10 1000 18000	0,05 10 200 1500	0,01 10 1000 1500	0,01 10 1000 18000	0,01 10 500 1500	0,01 10 2000 -	0,01 10 2000 25000
Kg sub if	Kg sub if	Kg sub if	Kg sub if	Kg sub if	Kg sub if	Kg sub if
12V - Empaque: Caja 10pcs.	5V - Empaque: Caja 10pcs	12V - Empaque: Caja 10pcs	12V - Empaque: Caja 10pcs.	12V - Empaque: Caja 10pcs	12V - Empaque: Caja 10pcs	12V - Empaque: Caja 10pcs
21W - Sin Casquillo	12W - Casquillo BA15S	21W - W3x16d	21W - Sin Casquillo	21/5W - W3x16q	10W - Sin casquillo	18W - Casquillo
43 max 20,5 max 29,0 ± 0,3	4,5 max	43 max 20,5 max 29,0 ± 0,3	43 max 20,5 max 29,0 ± 0,3	43 max 20,5 max 29,0 ± 0,3	9,5 13,0 120	38,35 max 32,0 max 29,0 max 4,5 max 7,5, 5,1

LÁMPARAS PARA VEHICULOS



HERRAMIENTAS NEUMÁTICAS

- 132 PISTOLAS DE IMPACTO
- 134 PARA CAMIONES
- 135 TALADROS/CARRACAS
- 136 CORTADORAS / KIT PULIDORA
- 137 AMOLADORAS
- 138 DESTALONADOR DE LLANTAS
/ESMIRILADORAS DE VÁLVULAS
- 139 LIJADORAS ORBITAL / PULIDORAS
- 141 MARTILLOS NEUMÁTICOS
- 142 DISCOS DE CORTE / EXPOSITORES
- 143 PISTOLAS DE INFLADO / DPF
- 144 FILTROS DE AIRE / ACEITES LUBRICANTES
- 145 PISTOLAS VARIAS
- 146 CARRETES MANGUERA DE AIRE
- 147 MANGUERAS DE AIRE / CONECTORES
- 148 ADAPTADORES / ENGANCHES

PISTOLA IMPACTO 1/2" COMPOSITE

53520 228,00€

1756Nm

COMPOSITE

2.40 5 10 160



- Con Torsión controlada.



SET DE REPARACIÓN PARA PISTOLA 53520

14121 26,00€

0.75 20



PISTOLA DE IMPACTO NANO 1/2"

53588 164,00€

1302Nm

1.65 5 385



SET DE REPARACIÓN PARA PISTOLA 53588

14165 26,50€

0.05 20



PISTOLA DE IMPACTO DE 1/2" COMPOSITE

51206 228,00€

COMPOSITE

1302Nm

1.46 5 10 300



SET DE REPARACIÓN PARA PISTOLA 51206

14120 22,00€

0.15 5



KIT PISTOLA DE IMPACTO DE 1/2" COMPOSITE + VASOS

51207 289,00€

COMPOSITE

1756Nm

3.95 5 80

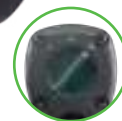

SET DE REPARACIÓN PARA PISTOLA 51207

14121 26,00€

0.75 20



17, 19, 21mm

PISTOLA DE IMPACTO ANGULAR 1/2"

53733 238,00€

650Nm

1.30 5 10 280



SET DE REPARACIÓN PARA PISTOLA 53733

14633 22,50€

0.03 20



PISTOLA DE IMPACTO 1/2" COMPOSITE

53608 98,00€

1200Nm

2.35 5 10 300



SET DE REPARACIÓN PARA 53608

14583 6,00€

0.01 20



PISTOLA DE IMPACTO 1/2" COMPOSITE

53689 238,00€

2.10 5 10 140



COMPOSITE



SET DE REPARACIÓN PARA PISTOLA 53689

14618 19,00€



1950Nm

VELOCIDAD Y POTENCIA REGULABLES CON UNA SOLA MANO

PISTOLA DE IMPACTO 1/2" COMPOSITE

53726 128,00€

2.35 - 10 240



1650Nm



SET DE REPARACIÓN PARA PISTOLA 53726

15564 11,90€



PISTOLA DE IMPACTO DE 3/4" CON ALARGADOR DE 15cm COMPOSITE

51210 650,00€

4.49 - 4 60



COMPOSITE

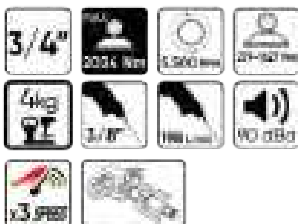

SET DE REPARACIÓN PARA PISTOLA 51210

14122 34,00€



15,24cm



2034Nm

PISTOLA DE IMPACTO DE 1" CON ALARGADOR DE 19cm COMPOSITE

51213 690,00€

4.93 - 4 60



COMPOSITE



SET DE REPARACIÓN PARA PISTOLA 51213

14123 33,00€



19cm



2034Nm

PISTOLA DE IMPACTO DE 3/4" COMPOSITE

51212 488,00€

3.77 - 4 128



COMPOSITE



SET DE REPARACIÓN PARA PISTOLA 51212

14122 34,00€



2034Nm

PISTOLA DE IMPACTO DE 1" COMPOSITE

51211 560,00€

3.86 - 4 60



COMPOSITE



SET DE REPARACIÓN PARA PISTOLA 51211

14123 33,00€



2034Nm

JBM RECOMIENDA EL USO DE SUS ACEITES LUBRICANTES PARA OPTIMIZAR EL RENDIMIENTO Y ALARGAR LA VIDA ÚTIL DE LA HERRAMIENTA

VER PÁG.144

14534 600ML



14560 100ML



PISTOLA DE IMPACTO PARA RUEDA DE CAMIÓN 1"

52814 528,00€

3260Nm

- Salida de aire: Parte superior.
- Fácil regulación de la velocidad de apriete y desapriete.

22,25	-	1	24
Kg	sub	ft	

670mm



1"	MAX 3260 Nm	1.600 rpm	18,5kg
424 L/min	1/2"	6 bar	90 PSI 18 CFM
x6 SPEED	111 dB	25 m³/h	



SET DE REPARACIÓN PARA PISTOLA 52814

14153 20,50€

0,05	-	15	-
Kg	sub	ft	



PISTOLA DE IMPACTO PARA CAMIONES 1" - ULTRALIGERA

53681 743,00€

2441Nm

798	-	2	50
Kg	sub	ft	

522mm

1"	MAX 2441 Nm	4.000 rpm	7,1kg
90 PSI 10 CFM	6.3 bar	1/2"	282 L/min
90 dBA	185mm	522mm	



SET DE REPARACIÓN PARA 53681

14336 58,00€

1,17	10	10	-
Kg	sub	ft	

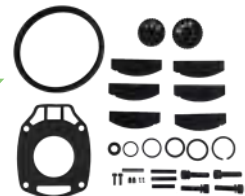

PISTOLA IMPACTO 1/2" DOBLE BLISTER

51222 128,00€

101Nm

1,09	-	20	240
Kg	sub	ft	

1/2"	MAX 101 Nm	1000-1800 rpm	0,9kg
7-60 Nm	6.3 bar	360°	



SET DE REPARACIÓN PARA PISTOLA 51222

14131 24,00€

0,01	-	10	-
Kg	sub	ft	



ACCIONAMIENTO MARIPOSA

TALADRO EN ÁNGULO DE 90° 3/8"

51221 199,00€

1,27	-	10	120
Kg	sub	ft	

- Reversible por ambos lados.
- Acabado en goma.

3/8"	1.500 rpm	1,2kg
1/4"	113 L/min	90°
85 dBA	3/8"	



SET DE REPARACIÓN PARA PISTOLA 51221

14130 21,00€

0,01	-	10	-
Kg	sub	ft	



KIT CARRACA MULTIFUNCIÓN DE 1/4" CON CABEZAL ABIERTO COMPOSITE

51225 198,00€

0,89 5 10 120



- Kit incluye:
Convertidor de 1/4" a 3/8".
Cabezal para Puntas de 1/4".
Set 2 puntas planas + 2 Puntas estrella.

COMPOSITE

40,7Nm



SET DE REPARACIÓN PARA PISTOLA 51225

14132 21,50€

0,01 - 10 -



TALADRO REVERSIBLE 1/2" COMPOSITE

51220 240,00€

1,64 - 10 120



- Reversible por ambos lados.



COMPOSITE

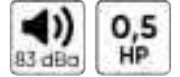

SET DE REPARACIÓN PARA PISTOLA 51220

14129 12,50€

0,01 - 10 -



CARRACA MINI DE 1/2" COMPOSITE

53784 148,00€

0,55 5 20 1200



COMPOSITE



133mm



SET DE REPARACIÓN PARA PISTOLA 53784

14779 33,00€

0,05 - 10 -



CARRACA MINI DE 1/4" COMPOSITE

51214 148,00€

0,55 5 20 -



COMPOSITE



133mm



SET DE REPARACIÓN PARA PISTOLA 51214

14124 20,50€

0,25 - 10 -



CARRACA DE 1/2" COMPOSITE

51215 119,00€

1,55 5 20 240



- Reversible.
- Rodamiento a bolas.
- Regulador de Aire.



SET DE REPARACIÓN PARA PISTOLA 51215

14125 19,50€

0,33 - 10 -



AMOLADORA ORBITAL COMPOSITE

51218 288,00€

2,27 5 10 120



- Acabado en goma.
- Mayor agarre.
- Palanca Reversible.

COMPOSITE



SET DE REPARACIÓN PARA PISTOLA 51218

14127 32,50€

0,01 - 10 -



HERRAMIENTA NEUMÁTICA PARA MONTAJE DE FUELLES DE PALIER

51861 199,00€

4,00 - 2 32



- Material: aluminio.
- Apertura de 20 a 100mm.

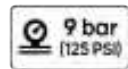

CORTADORA EXTRALARGA

51219 222,00€

2.10 5 10 120



- Acabado en goma.
- Palanca de seguridad en 8 posiciones.

400mm

RECAMBIOS EN PÁG.142

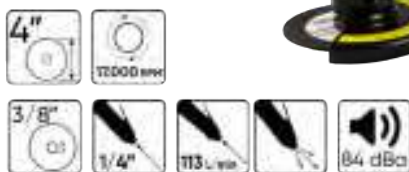

PROTECTOR ANTI CHISPAS

SET DE REPARACIÓN PARA 51219

14128 13,50€

0,01 - 10 -



KIT LIJADORA ORBITAL

51226 233,00€

1.52 - 10 120



- Acabado en goma.
- Palanca de seguridad.
- Diseño MINI.
- Incluye Gafas, llaves y discos de 2".



SET DE REPARACIÓN PARA PISTOLA 51226

14133 16,50€

0,01 - 10 -



RECAMBIOS EN PÁG.142

KIT CORTADOR NEUMÁTICO CON SALIDA TRASERA

51227 193,00€

2.03 - 10 120



- Acabado en goma.
- Palanca de seguridad.
- Diseño MINI.
- Incluye Gafas, llaves, allen y 10 discos 3".



SET DE REPARACIÓN PARA PISTOLA 51227

14134 17,50€

0,01 - 10 -



RECAMBIOS EN PÁG.142

KIT PULIDORA

51216 650,00€

4.33 - 4 16



- Incluye: Distintos tipos de discos (para la preparación de superficies metálicas previo a la remediación de trabajo). 11mm - cepillo de alambre (fino). 23mm - cepillo de alambre (fino). 11mm - cepillo de alambre (grueso). 23mm - cepillo de alambre (grueso). Borrador de goma.

- Borrador de pinturas con base de agua.
- Adaptador de 23mm para borrador de goma y cepillo de alambre.
- Adaptador de 11mm cepillo de alambre.
- Pulidor negro de caucho (hasta 6 piezas).
- Adaptor único de pulidor caucho.
- Adaptador de doble tira de caucho.
- Allen.



19 PCS

1,2kg

MANGO ANATOMICO

ACCESORIOS

ADAPTADORES

Para rueda de 23mm

51439 26,00€



Para rueda de 11mm

51440 28,00€



Rueda negra doble

51441 26,00€



Rueda negra simple

51442 28,00€



RUEDAS RASCADORAS

Cepillo - rueda rascador de pintura 0105mm

51392 34,00€

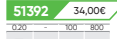

Cepillo rascador de pintura al agua 0105mm

51393 34,00€



SET DE REPARACIÓN PARA PISTOLA 51216

14126 54,00€

0,01 - 10 -



ESMERILADOR DE VÁLVULAS PARA TALADRO

54033 49,00€

0.30 5 20 720



- Diámetro ventosas: 16, 20, 30, 35, 40mm
- Conexión taladro: 8mm
- Longitud: 128mm
- Velocidad de trabajo máxima: 1250rpm



PISTOLA DE SILICONA NEUMÁTICA

53567 43,00€

1.05 - 10 180



- Presión de trabajo: 2,5-5 BAR.
- Entrada de aire: 1/4".
- Capacidad del cartucho: 310ml.

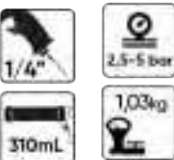

MINI AMOLADORA DE 3/8" 6mm

51245 99,00€

0.60	-	20	240
Kg	Sub	ft	mm



SET DE REPARACIÓN
PARA PISTOLA 51245

14135 12,50€

0.01	-	10	-
Kg	Sub	ft	mm



MINI AMOLADORA 1/4"

53137 38,00€

0.55	5	20	720
Kg	Sub	ft	mm



PISTOLA DE IMPACTO 3/4"

53343 285,00€

790	-	2	72
Kg	Sub	ft	mm



1600Nm



PISTOLA DE IMPACTO 1"

53344 295,00€

8.05	-	2	80
Kg	Sub	ft	mm



1600Nm



PULIDORA ANGULAR 1/4"

53141 68,00€

0.60	5	20	1120
Kg	Sub	ft	mm



1/4"

PULIDORA ANGULAR NEUMÁTICA

52528 49,00€

0.70	5	20	960
Kg	Sub	ft	mm

- Cuerpo fabricado en aluminio con recubrimiento de goma ergonómico.



GATILLO CON SISTEMA DE SEGURIDAD INCORPORADO

SIERRA NEUMÁTICA

52574 69,00€

0.73	4	20	640
Kg	Sub	ft	mm

- 2 Sierras recambio 95mm de 32 dientes.
- 2 Llaves allen.
- 1 protector de sierra.
- Enganche rápido.



5 HOJAS DE SIERRA 24
DIENTES PARA MADERA

11956 5,50€

0.03	10	300	-
Kg	Sub	ft	mm

5 HOJAS DE SIERRA 32
DIENTES PARA HIERRO

11957 5,50€

0.01	10	250	-
Kg	Sub	ft	mm

REMACHADORA NEUMÁTICA

52575 119,00€

1.75	5	10	140
Kg	Sub	ft	mm

2,4mm (3/32), 3,2mm (1/8),
4,0mm (5/32), 4,8mm (3/16)

- Tracción: 1586LBS / 720 KGS.
- Largo de varilla: 9/16" - 14mm.
- Max. apriete 60FT LB / 23-69NM.
- Consumo aire medio: 0.03CFM/0.86L/Min.
- Entrada de aire: 1/4".

- Contiene:
- Cubeta trasera receptora
- 2 Multiherramientas
- Enganche rápido
- Juntas tóricas



CIZALLA NEUMÁTICA

53541 168,00€

1.60	5	10	-
Kg	sub	ff	sub

- Cizalla neumática profesional ideal para cortar aluminio, otros metales, caucho y plásticos en general, con una capacidad de corte de 1,02mm.
- Agarre de pistola ergonómico para un uso cómodo y gatillo fácil de usar.
- Permite cortar recto, en ángulo o en círculos sin deformación de bordes.

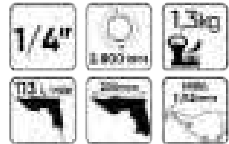

SET DE REPARACIÓN PARA CIZALLA NEUMÁTICA 53541

14136 12,00€

0.01	5	-
Kg	sub	ff



1/4"

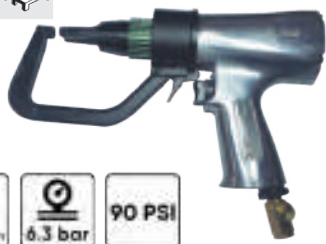

CORTADORA NEUMÁTICA

53140 98,00€

0.99	-	14	400
Kg	sub	ff	sub



RECAMBIO DISCO PARA REF. 53140

14013 3,50€

0.01	-	1000
Kg	sub	ff

TALADRO NEUMÁTICO PARA SOLDADURAS CON DESPLAZAMIENTO DE LA BROCA CENTRAL

52724 381,00€

2.55	-	6	84
Kg	sub	ff	sub



52725 349,00€

2.35	-	10	180
Kg	sub	ff	sub

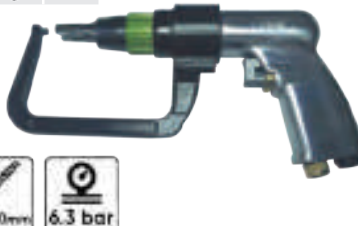

1/4"

BROCA PARA TALADRO PARA REF. 52725 Y 52724

13817 17,00€

0.10	-	500	-
Kg	sub	ff	sub

6,5mm

13818 20,50€

0.10	-	500	-
Kg	sub	ff	sub

8mm

DESTALONADOR DE LLANTAS NEUMÁTICO

53542 980,00€

6.35	-	4	40
Kg	sub	ff	sub



- Destalonador de llantas neumático profesional especialmente diseñado para su aplicación en vehículos agrícolas, industriales y en la mayoría de camiones.
- Extremadamente rápido: ahorra tiempo con respecto a los rompedores hidráulicos convencionales.
- Permite desmontajes in-situ en el lugar de trabajo de la máquina.
- Excelente para trabajar sobre el neumático sin quitar la rueda: afloja el talón del neumático de la llanta con apalancamiento.

ESPECIAL VEHÍCULO AGRÍCOLA/INDUSTRIAL

- Especificaciones técnicas:
Capacidad de apertura: 68mm.
Extensión del pistón: 80mm.
Entrada de aire: 1/4".
Consumo de aire: 113 L/min.
Largo: 396mm.
Peso: 4,6kg.
10.000 RPM



SET DE REPARACIÓN PARA PISTOLA 53542

14137 131,00€

0.65	5	5	-
Kg	sub	ff	sub

HERRAMIENTA NEUMÁTICA PARA ESMERILAR VÁLVULAS - PERCUSIÓN Y ROTACIÓN

53572 348,00€

1.90	-	5	80
Kg	sub	ff	sub

- Contenido:
1 x Máquina neumática para válvulas.
5 x Adaptador de válvula.
1 x 3 mm Llave Allen.
5 x Ventosa (16, 20, 30, 35 y 45 mm).

REGULA LA VELOCIDAD

14157 8,30€

0.01	-	50	-
Kg	sub	ff	sub

14160 12,80€

0.01	-	50	-
Kg	sub	ff	sub

14158 9,95€

0.01	-	50	-
Kg	sub	ff	sub

14161 13,70€

0.10	-	50	-
Kg	sub	ff	sub

14159 12,60€

0.01	-	50	-
Kg	sub	ff	sub



GIRO DERECHO + GIRO IZQUIERDO

KIT LIJADORA ORBITAL AUTO-ASPIRANTE

52676 98,00€

1.45	5	10	80
Kg	Sub	11	11

- Cuerpo de aluminio con empuñadura engomada.
- Excelente limpieza con bolsa y manguera.



LIJADORA ORBITAL ADAPTABLE A ASPIRADOR

52675 84,00€

1.25	5	10	160
Kg	Sub	11	11

52758 88,00€

1.33	5	10	160
Kg	Sub	11	11

200mm

Cuerpo de aluminio con empuñadura engomada



DISCOS PARA LIJADORAS



DISCO DE 6 AGUJEROS PARA 52675, 52758, 52676

12009 11,00€

0.14	50	-
Kg	Sub	11

Ø 150mm



DISCO DE 66 AGUJEROS PARA 52675, 52758, 52676

13500 12,90€

0.65	5	50	-
Kg	Sub	11	11

Rosca 5/16" Ø 149mm

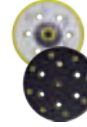

DISCO DE 15 AGUJEROS PARA 52675, 52758, 52676

13499 12,50€

0.10	50	1500
Kg	Sub	11

Rosca 5/16" Ø 147mm

KIT MINI PULIDORA NEUMÁTICA 3"

53576 189,00€

1.85	-	5	70
Kg	Sub	11	11

- El kit incluye:
- 1x pulidora neumática de 3".
- 1x disco de lijado de velcro (instalado).
- 1x llave para tuercas.
- 3x esponjas pulidoras con reverso de velcro.



VELOCIDAD REGULABLE

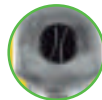

KIT PULIDORA NEUMÁTICA DE 3"

53646 62,00€

0.85	5	10	400
Kg	Sub	11	11

- Ideal para trabajar y pulir superficies de pintura, metal y plástico con un acabado altamente brillante.
- Su tamaño reducido permite maniobrar fácilmente accediendo a los puntos más difíciles.
- Con regulador de velocidad ajustable por gatillo.



ESPONJA DE LANA PARA REF. 53576

14162 25,50€

0.05	50	-
Kg	Sub	11

ESPONJA SÓLIDA PARA REF. 53576 - AMARILLA

14164 25,50€

0.50	5	50	-
Kg	Sub	11	11

ESPONJA BLANDA PARA 53576 - BLANCA

14163 25,50€

0.50	5	50	-
Kg	Sub	11	11

DISCO DE VELCRO PARA REF. 53576

14330 3,50€

0.01	5	50	-
Kg	Sub	11	11

SET DE REPARACIÓN PULIDORA

14154 42,00€

0.05	10	-
Kg	Sub	11

ESPONJA NARANJA DE POLIÉTER PARA REF. 53646

14286 2,99€

0.01	200	-
Kg	Sub	11

ESPONJA DENSA REF. 53646

14287 2,99€

0.01	200	-
Kg	Sub	11

ESPONJA DE LANA PARA REF. 53646

14288 6,00€

0.01	10	200	-
Kg	Sub	11	11

DISCO DE VELCRO PARA REF. 53646

14289 6,10€

0.10	200	-
Kg	Sub	11

JBM RECOMIENDA EL USO DE SUS ACEITES LUBRICANTES PARA OPTIMIZAR EL RENDIMIENTO Y ALARGAR LA VIDA ÚTIL DE LA HERRAMIENTA

VER PÁG.144

14534 600ML



14560 100ML



KIT DE PULIDO DE FAROS

53626 18,00€

0,30 - 12 576



Este kit está hecho para **restaurar 2 faros**.

- Características:
Diseñado para restaurar la claridad de las lentes de los faros que se han vuelto amarillentas, turbias o nebulosas.
Mejora el rendimiento de las lentes de los faros.
Tres pasos sencillos: lijar, pulir y proteger.
Restaura los faros delanteros, las luces traseras, los faros antiniebla o las luces direccionales.

- Contenido del kit:
2x P800 Disco para lijar.
2x P1200 Disco para lijar.
2x P2000 Disco para lijar.
1x 85g Pasta Pulidora.
2x 3.0ml Líquido protector UV.
1x Cinta adhesiva.
1x Disco Pulidor de Lana.
1x Disco Esponja Blanca.
1x Almohadilla de soporte M10 Rosca.
2x Adaptador (3/8" & 1/4").



SERIE ESPECIAL PULIDO: PULIDORA + KIT FAROS X12

SERIE262 199,00€

5,25 - - -



KIT HERRAMIENTAS NEUMÁTICAS

52331 201,00€

790 - 2 48



PISTOLA DE IMPACTO + MARTILLO NEUMÁTICO + CARRACA NEUMÁTICA + MINI PULIDORA NEUMÁTICA + PISTOLA DE SOPLADO + PISTOLA DE SOPLADO RECTA + ACCESORIOS

1x Pistola impacto 1/2"
1x Martillo neumático 150mm
1x Carraca neumática 3/8"
1x Pulidora neumática
1x Muelle de retención
1x Barra de extensión 1/2" - 75mm
1x Aceitera mini
1x Llave hex. 4mm
8x Vasos impacto: 12, 13, 17, 19, 1/2", 9/16", 5/8", 11/16"
1x Pistola de soplado
1x Mini pistola de soplado
1x Cinta teflón
4x Escarpas 120mm
2x Llaves fijas manuales
5x Disco de lijado 1/4"

5x Disco de lijado 1/2"
5x Piedras de pulir 1/4"
5x Piedra de pulir 3/8"
2x Cilindros de lijado (3/4" y 1")
1x Adaptador rápido hembra
1x Conector de escarpa
8x Tetones de soplado
1x Conector M-M conexión rápida
2x Collares 1/8"
1x Conector rápido M-H
1x Boquilla de goma
1x Boquilla cónica
1x Aguja de inflado
1x Boquilla de alta presión
1x Boquilla de seguridad
1x Caja de plástico



ESTUCHE 16 PIEZAS NEUMÁTICAS CON PISTOLA Y CARRACA IMPACTO

52156 140,00€

5,36 - 4 112



PISTOLA DE IMPACTO:



CARRACA NEUMÁTICA:
ADAPTADOR M / H



PISTOLA DE IMPACTO DE 1/2"

52165 118,00€

610Nm

290 - 6 168



CARRACA NEUMÁTICA DE 1/2"

52167 48,00€

61Nm

1,25 5 10 560



MARTILLETE DE AGUJAS NEUMÁTICO

53625 68,00€

2,15 5 10 320



- Velocidad de impacto:
4500BPM
- 19 agujas
- Peso: 1,97kg

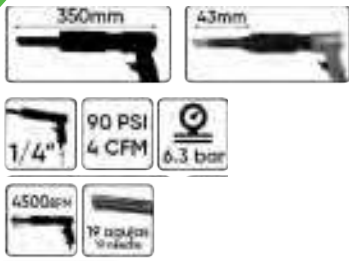

AGUJA RECAMBIO
PARA REF. 53625

14188 0,50€

0,00 50 200 -



Recorrido: 43mm

MARTILLO CINCELADOR NEUMÁTICO

52718 48,00€

1,95 4 8 144



9
PCS

TALADRO REVERSIBLE NEUMÁTICO DE 1/2"

52159 64,00€

1,79 5 10 240



TALADRO NEUMÁTICO RECTO - 3/8" Dr.

53573 36,00€

0,75 5 20 -



- Compatible con brocas de 1,5-10mm.

TALADRO REVERSIBLE NEUMÁTICO DE 3/8"

52160 48,00€

1,22 5 10 400



TALADRO REVERSIBLE NEUMÁTICO 3/8" EN ÁNGULO DE 90°

52527 82,00€

1,22 5 10 480



ESTUCHE DE 16 PIEZAS CON AMOLADORA NEUMÁTICA

52157 48,00€

0,90 5 10 240



MINI AMOLADORA NEUMÁTICA 1/4"

52171 39,00€

0,40 5 20 1080

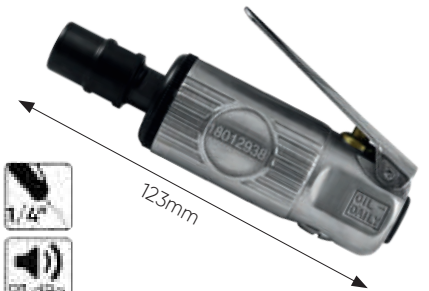

JBM RECOMIENDA EL USO DE SUS ACEITES LUBRICANTES PARA OPTIMIZAR EL RENDIMIENTO Y ALARGAR LA VIDA ÚTIL DE LA HERRAMIENTA

VER PÁG.144

14534
600ML



14560
100ML



CORTADORA NEUMÁTICA DE 3"

52953 38,00€

0,90 5 20 420



DISCO DE CORTE 3"
PARA REF. 52953

12987 1,50€



DISCOS DE CORTE

PARA REF. 51227

51387 3,25€

Ø Interior: 9,53mm
Ø Exterior: 75mm

3"



PARA REF. 51219

51385 4,55€

Ø Interior: 9,53mm
Ø Exterior: 100mm

4"x1/32"



DISCOS DE LIJAR

PARA REF. 51218

51386 5,95€



Ø Interior: 22mm
Ø Exterior: 125mm

5"



PARA REF. 51226

51444 5,05€



Ø Exterior: 2"

#80



PARA REF. 51226

51443 5,50€



Ø Exterior: 2"

#60



PARA REF. 51226

51445 5,05€



Ø Exterior: 2"

#120



EXPOSITOR DE HERRAMIENTA NEUMÁTICA

53492 380,00€

13,00 - 1 7



HERRAMIENTAS
NO INCLUIDAS



COLGADOR IMANTADO PARA HERRAMIENTA NEUMÁTICA

52378 10,00€

0,36 10 40 720



3Kg

Ø 6cm



52378

51341 35,00€

1,62 - 12 96



9Kg

Ø 7cm



51341

EXPOSITOR DE HERRAMIENTAS NEUMÁTICAS

53147 41,00€

1,15 5 10 200



HERRAMIENTAS
NO INCLUIDAS



PISTOLA DE INFLADO

ANALÓGICA

53449 14,00€

0.45	5	20	320
Kg	SUB	ff	ff

0-7 bar
0-100 PSI



RETROILUMINACIÓN DE PANTALLA

DIGITAL

53450 28,30€

0.40	5	20	320
Kg	SUB	ff	ff



- Pilas incluidas.

PISTOLA LIMPIADORA DE FILTROS DE PARTÍCULAS

52543 182,00€

0.84	-	6	90
Kg	SUB	ff	ff

- Universal.
- Capacidad Máxima 650cc.
- Manguera de Nylon de 4x6x2,7m.
- Rango de presión de trabajo: 3 bar - 7 bar.
- Cuerpo inoxidable de larga duración + base de aluminio.



LÍQUIDO DESCARBONIZANTE

90003 35,20€

1.08	-	12	400
Kg	SUB	ff	ff



LÍQUIDO NEUTRALIZANTE

90004 25,80€

0.50	-	12	320
Kg	SUB	ff	ff



PISTOLA DE AIRE + PISTOLA PARA INFLAR NEUMÁTICOS

51981 21,50€

0.58	5	20	240
Kg	SUB	ff	ff



PISTOLA DE AIRE PARA INFLAR NEUMÁTICOS

51980 15,00€

0.40	5	25	450
Kg	SUB	ff	ff



MEDIDOR DE PRESIÓN DE NEUMÁTICOS

52648 9,00€

0.08	5	100	2000
Kg	SUB	ff	ff

5-6 bar



CON TUBO

53416 14,10€

0.20	10	100	800
Kg	SUB	ff	ff

0-10 bar



DIGITAL CON TUBO

53417 26,30€

0.25	10	100	800
Kg	SUB	ff	ff

0-15 bar
0-220 PSI

0-1.500 KPA



DIGITAL

53418 16,90€

0.20	10	100	800
Kg	SUB	ff	ff

0-15 bar
0-220 PSI

0-1.500 KPA



PISTOLA ENGRASADORA NEUMÁTICA

50751 43,00€

1.50	5	10	150
Kg	SUB	ff	ff

- Presión: 30Mpa.



500ml

JBM RECOMIENDA EL USO DE SUS ACEITES LUBRICANTES PARA OPTIMIZAR EL RENDIMIENTO Y ALARGAR LA VIDA ÚTIL DE LA HERRAMIENTA

VER PÁG.144

14534
600ML



14560
100ML



SET DE HERRAMIENTAS DE AIRE COMPRIMIDO

51277 64,00€

1.84 - 5 60



- 1x Pistola para pintar por gravedad con tanque de 600ml.
- 1x Inflador de neumáticos con manómetro de presión.
- 1x Pistola de aire.
- 1x Pistola de soplear con tanque para solución de limpieza.
- 1x Manguera espiral de 5x8mm con conexión rápida 1/4" extensible hasta 4,5m.



PISTOLA DE SOPLADO EN BLISTER

51383 11,10€

0.27 10 50 650



- Pistola de aire.
- Enganche rápido europeo.
- Enganche de manguera.
- Extensor de tubo 10 cm.
- Extensor de tubo 20 cm.



EN EXPOSITOR DE 10 UNIDADES



PISTOLA DE AIRE EXTENSIBLE

52798 18,00€

0.25 10 50 700



285-530mm



PUNTA RECUBIERTA DE GOMA PARA EVITAR RAYADAS

PISTOLA DE AIRE

52490 6,65€

0.10 10 40 960



100mm

52491 10,50€

0.15 10 80 800



300mm



EN EXPOSITOR DE 10 UNIDADES

PISTOLA DE AIRE EXTRALARGA

53611 27,50€

0.50 - 40 160



1.020MM



GRAN CAUDAL

PISTOLA DE SOPLADO GRAN CAUDAL

53205 19,00€

0.90 - 48 500



- Pistola de soplado de gran caudal.
- Material del cuerpo: Aleación de aluminio.
- Superficie: Niquelado.



GRAN CAUDAL

PISTOLA DE SOPLADO EN BLISTER INDIVIDUAL

52787 9,00€

0.20 25 100 1000



PISTOLA DE SOPLADO DE 3/8" CON MANGUERA DE 5m

52381 20,50€

0.45 5 25 200



FILTRO Y REGULADOR DE AIRE

53063 36,70€

0.60 5 50 300



1/4"

53064 37,40€

0.63 5 50 300



3/8"

53065 36,90€

0.60 5 50 300



1/2"



FILTRO, REGULADOR DE AIRE Y LUBRICADOR

53066 61,00€

1.08 5 25 250



1/4"

53067 61,00€

0.50 5 25 250



3/8"

53068 63,00€

1.00 5 25 250



1/2"



CONECTOR LUBRICANTE 1/4"

14561 8,80€

0.05 25 50 -



1/4"



ACEITE LUBRICANTE PARA HERRAMIENTAS NEUMÁTICAS

14534 16,50€

0.55 - 12 540



600ml



14560 8,80€

0.10 12 72 1008



100ml



- Densidad relativa a 15°C: 0,845.
- Viscosidad: 12,1 cSt a 40°C.
- Color: Incoloro.

PISTOLA NEUMÁTICA PARA PINTAR

54248 58,00€

0,63 5 20 240
Kg sub ft in

160-240 mm
600ml
Ø 1,8mm



PISTOLA NEUMÁTICA PARA PINTAR PROFESIONAL

54249 103,00€

0,71 5 20 240
Kg sub ft in

180-260 mm
600ml
Ø 1,4mm



PISTOLA DE SECADO NEUMÁTICA

53606 55,00€

0,60 5 20 -
Kg sub ft in

1/4" 30-60 PSI 2-4 bar
325 l/min AL

CE



VÁLVULA REGULADORA DE AIRE



PISTOLA CHORREADORA DE ARENA

53593 41,00€

2,75 - 5 80
Kg sub ft in

- Ideal para la carrocería del coche y todo tipo de superficies metálicas: permite quitar la oxidación, la suciedad excesiva y/o el revestimiento, barniz etc. fácilmente.

- Incluye:
1x Pistola chorreadora.
1x Recogedor de arena.
2x Botes arena de 850g.
4x Casquillos:
para chorreado.
para chorreado en superficie.
para chorreado de esquina exteriores.
para chorreado de esquina interiores.



- Tamaño grano: 46-100MeSH 0.354-0.149mm

3-5 bar 0,5 CFM 90-120 PSI 1/4"

BOTELLA DE ARENA PARA REF. 53593

14168 7,00€

0,95 - 20 -
Kg sub ft in



PISTOLA DE PETROLEAR

53202 15,70€

1,40 - 10 80
Kg sub ft in

- Pistola de limpieza del motor.
- Material del bote: Acero.
- Material del cuerpo: Aleación de aluminio.
- Superficie: Pintura en polvo.

900cc Presión de trabajo 40-120 PSI 2.7-8 BAR Presión máxima 14.5 PSI 10 BAR



PISTOLA DE LIMPIEZA TORNADO

53204 81,00€

0,90 - 5 60
Kg sub ft in

1/4" 6-9.2 bar 1000 ml

- Pistola de limpieza de coches, tornado.
- Material pote: PE.
- Material del cuerpo: Aleación de aluminio.
- Superficie del cuerpo: Pulido.

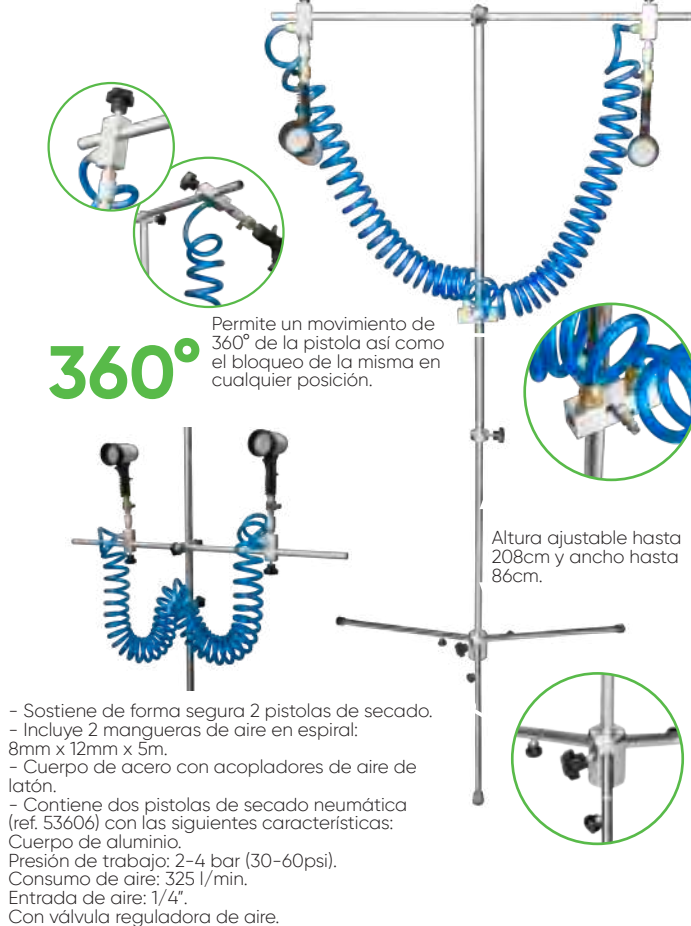

CARRETE DE MANGUERA DE AIRE 20+2m

53582 179,00€

10.85	-	1	14
Kg	Sub	ff	ff

53583 170,00€

10.75	-	1	14
Kg	Sub	ff	ff



SOPORTE DE PARED

14772 8,50€

0.35	-	20	-
Kg	Sub	ff	ff

CARRETE DE MANGUERA DE AIRE 12+1m

53532 119,00€

6.80	-	2	30
Kg	Sub	ff	ff

53581 115,00€

6.70	-	2	30
Kg	Sub	ff	ff



SOPORTE DE PARED

14771 10,50€

0.35	-	30	-
Kg	Sub	ff	ff

CARRETE DE MANGUERA DE AIRE 11m

53881 79,00€

4.50	-	4	48
Kg	Sub	ff	ff

53882 79,00€

4.50	-	4	48
Kg	Sub	ff	ff

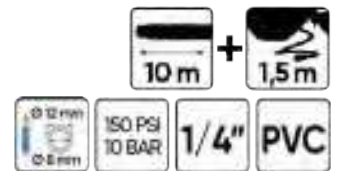

MANGUERAS DE AIRE EN ESPIRAL

53629 14,30€	10m	53630 18,80€	15m
0.55 - 6 372	8mm, 5mm	0.65 - 6 240	8mm, 5mm
Kg SUB	conector 1/4"	Kg SUB	conector 1/4"
53632 46,00€	15m	53631 33,50€	15m
2.20 - 6 78	15mm, 10mm	1.25 - 6 132	12mm, 8mm
Kg SUB	conector 1/4"	Kg SUB	conector 1/4"
53634 63,00€	15m	53633 46,00€	15m
2.60 - 6 66	18mm, 13mm	2.10 - 6 78	15mm, 10mm
Kg SUB	conector 2"	Kg SUB	conector 3/8"

CON EXTREMOS GIRATORIOS DE 360 GRADOS PARA UN FÁCIL MOVIMIENTO Y FACILIDAD DE USO

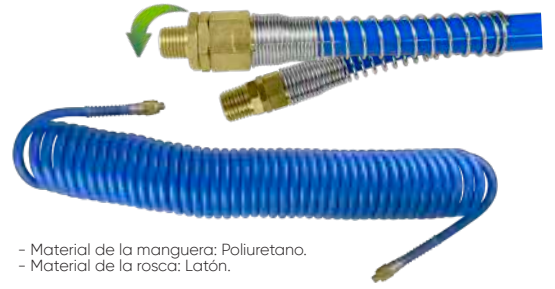

- Material de la manguera: Poliuretano.
- Material de la rosca: Latón.

MANGUERA DE AIRE

53594 54,00€	53595 61,00€
3.10 - 4 96	3.20 - 4 96
Kg SUB	Kg SUB



- Presión de trabajo: 300PSI / 20bar.
- Presión de rotura: 950PSI / 65bar.
- Temperatura de trabajo: -40°C / 65°C

- Gran flexibilidad.
- Regresa a su forma original.
- Superficie suave, no daña pintura.
- Muy resistente.



Diámetro interior: 8mm
Diámetro exterior: 13mm
Para utilizar con:
Ref. 52736 M8



Diámetro interior: 10mm
Diámetro exterior: 15mm
Para utilizar con:
Ref. 52737 M10

25m 300 PSI 20 BAR
POLÍMERO HÍBRIDO



x10 BOLSA DE 10 ABRAZADERAS 8-16mm

14169 3,00€
0.10 - 125 -
Kg SUB

CONECTOR UNIVERSAL DE SEGURIDAD PARA MANGUERA

14201 4,00€	M6
0.10 25 100 -	
Kg SUB	
14202 4,00€	M8
0.10 25 100 -	
Kg SUB	
14203 4,50€	M10
0.10 25 100 -	
Kg SUB	

CONECTOR ARTICULADO MACHO PARA AIRE COMPRIMIDO

14314 5,00€	14315 4,50€
0.06 25 100 -	0.06 25 100 -
Kg SUB	Kg SUB
	EUR 1/4"
	US 1/4"

CONECTOR PARA MANGUERA

REF.	DESCRIPCIÓN	Kg	€
14204	EUR - M6	0,06	1,50€
14205	EUR - M8	0,06	1,50€
14206	EUR - M10	0,06	1,50€
14207	US - M6	0,06	1,50€
14208	US - M8	0,06	1,50€
14209	US - M10	0,06	1,50€

CONECTOR DE SEGURIDAD UNIVERSAL

REF.	DESCRIPCIÓN	Kg	€
14195	CONECTOR HEMBRA - ROSCA MACHO 1/4"	0,5	4,00€
14196	CONECTOR HEMBRA - ROSCA MACHO 3/8"	0,10	4,00€
14197	CONECTOR HEMBRA - ROSCA MACHO 1/2"	0,10	4,50€
14198	CONECTOR HEMBRA - ROSCA HEMBRA 1/4"	0,10	4,00€
14199	CONECTOR HEMBRA - ROSCA HEMBRA 3/8"	0,10	4,00€
14200	CONECTOR HEMBRA - ROSCA HEMBRA 1/2"	0,10	4,50€

CONECTOR / ROSCA

REF.	DESCRIPCIÓN	Kg	€
US			
13930	CONECTOR MACHO - ROSCA MACHO 1/4"	0,05	1,50€
13932	CONECTOR MACHO - ROSCA MACHO 3/8"	0,1	2,50€
14076	CONECTOR MACHO - ROSCA HEMBRA 3/8"	0,1	1,50€
13933	CONECTOR MACHO - ROSCA MACHO 1/2"	0,1	2,00€
13935	CONECTOR MACHO - ROSCA HEMBRA 1/4"	0,05	2,50€
13936	CONECTOR HEMBRA - ROSCA HEMBRA 1/4"	0,05	3,50€
13937	CONECTOR HEMBRA - ROSCA MACHO 1/4"	0,05	4,00€
14078	CONECTOR HEMBRA - ROSCA HEMBRA 3/8"	0,1	4,00€
14191	CONECTOR MACHO - ROSCA HEMBRA 1/2"	0,1	2,00€
14193	CONECTOR HEMBRA - ROSCA HEMBRA 1/2"	0,1	4,00€
EURO			
13931	CONECTOR MACHO - ROSCA MACHO 1/4"	0,05	2,50€
14075	CONECTOR MACHO - ROSCA HEMBRA 3/8"	0,1	2,00€
13934	CONECTOR MACHO - ROSCA HEMBRA 1/4"	0,05	2,50€
13938	CONECTOR HEMBRA - ROSCA HEMBRA 1/4"	0,1	3,50€
13939	CONECTOR HEMBRA - ROSCA MACHO 1/4"	0,1	4,00€
14077	CONECTOR HEMBRA - ROSCA HEMBRA 3/8"	0,1	4,50€
14190	CONECTOR MACHO - ROSCA HEMBRA 1/2"	0,1	2,00€
14192	CONECTOR HEMBRA - ROSCA HEMBRA 1/2"	0,1	4,00€

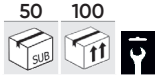

ENGANCHE NEUMÁTICO RÁPIDO

52735	4,85€	M6	52736	5,35€	M8	52737	5,50€	M10			
0.05	25	200	4000	0.10	25	200	4000	0.10	25	200	4000
Kg	SUB	ff		Kg	SUB	ff		Kg	SUB	ff	



- Contiene conector macho + conector hembra.

ADAPTADOR ARTICULADO NEUMÁTICO

12988	12,00€	1/2"	13809	18,50€	1/4"	13810	20,50€	3/8"			
0.15	62	125	-	0.10	62	250	-	0.10	62	250	-
Kg	SUB	ff		Kg	SUB	ff		Kg	SUB	ff	





ÚTILES, VASOS Y PUNTAS DE IMPACTO

- 150 SETS DE VASOS DE IMPACTO
- 152 BARRAS DE EXTENSIÓN
/ ARTICULACIONES DE IMPACTO
- 153 SETS DE PUNTAS
- 154 ADAPTADORES DE IMPACTO
/ VASOS DE IMPACTO DE 3/4" Y 1"
- 156 UTILAJE DE IMPACTO VEHÍCULOS PESADOS

SET DE 3 VASOS Y 3 PUNTAS DE IMPACTO DE 1/2" HEX

52337 65,00€

1,91 5 10 300



CONTIENE

x3	30, 32, 36mm
x3	14, 17, 19mm

SET DE 5 VASOS Y 3 PUNTAS DE 12 CANTOS DE IMPACTO DE 1/2"

52547 96,00€

2,70 - 5 200



CONTIENE

x4	27, 30, 32, 34, 36mm
x3	M14, M16, M18

SET DE 13 PIEZAS DE IMPACTO CON VASOS DE 1/2" HEX + ADAPTADOR

52341 58,00€

1,70 - 4 336



10, 11, 12, 13, 14, 17, 19, 21, 22, 24mm

DESPIECE DISPONIBLE

REF.	mm	Kg	SUB	ff	mm	€
14728	10mm	0,10	5	20	3,80€	
14729	11mm	0,05	5	20	3,80€	
14730	12mm	0,05	5	20	3,80€	
14731	13mm	0,10	5	20	3,80€	
14732	14mm	0,10	5	20	3,80€	
11195	17mm	0,10	10	50	3,70€	
11121	19mm	0,10	10	60	4,10€	
14733	21mm	0,10	5	20	4,30€	
14734	22mm	0,15	5	20	5,40€	
11122	24mm	0,15	10	20	5,45€	
REF.	mm	Kg	SUB	ff	mm	€
14735	Adaptador impacto	0,05	5	20	6,50€	
12074	Barra de ext. imp. 125mm	0,23	10	60	11,50€	
11990	Articu. univ. de imp.	0,15	100	100	15,30€	

KIT DE 3 VASOS DE 12 CANTOS DE 1/2"

52694 49,00€

1,31 5 10 600

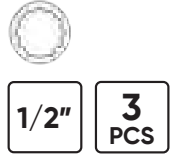

30, 32, 36mm (78mmL)

SET DE 19 PIEZAS DE IMPACTO DE 1/2" CON 14 VASOS + ADAPTADORES

52345 109,00€

3,55 - 6 240



53531 109,00€

3,55 - 4 240



52345: DESPIECE DISPONIBLE

REF.	mm	Kg	SUB	ff	mm	€
14728	10mm	0,10	5	20	3,80€	
14729	11mm	0,05	5	20	3,80€	
14730	12mm	0,05	5	20	3,80€	
14731	13mm	0,10	5	20	3,80€	
14732	14mm	0,10	5	20	3,80€	
14970	15mm	0,08	5	20	2,50€	
14971	16mm	0,07	5	20	2,50€	
11195	17mm	0,10	10	50	3,70€	
14972	18mm	0,12	5	20	3,50€	
11121	19mm	0,10	10	60	4,10€	
14733	21mm	0,10	5	20	4,30€	
14734	22mm	0,15	5	20	5,40€	
11122	24mm	0,15	10	20	5,45€	
11123	27mm	0,35	10	50	6,50€	
12937	Barra de extensión impacto 50mm	0,11	10	100	9,50€	
14973	Barra de extensión impacto 150mm	-	5	20	11,50€	
12075	Barra de extensión impacto 250mm	0,45	10	50	15,50€	
11962	Adaptador de impacto 1/2"H 3/4"M	0,15	10	100	7,50€	
11990	Articulación universal de impacto	0,15	10	100	15,30€	

SET DE 15 PIEZAS DE IMPACTO CON 12 VASOS LARGOS DE 1/2" HEX + ADAPTADOR

52346 103,00€

4,55 - 6 252



DESPIECE DISPONIBLE

REF.	mm	Kg	SUB	ff	mm	€
12071	24mm	0,30	10	50	11,00€	
12072	27mm	0,35	10	20	12,00€	
12074	Barra de extensión impacto 125mm	0,23	10	60	11,50€	
12075	Barra de extensión impacto 250mm	0,45	10	50	15,50€	
11990	Articulación universal de impacto	0,15	10	100	15,30€	
REF.	mm	Kg	SUB	ff	mm	€
12061	10mm	0,14	10	100	9,50€	
12062	12mm	0,15	10	100	9,50€	
12063	13mm	0,15	10	50	9,50€	
12064	15mm	0,17	10	100	9,00€	
12065	16mm	0,30	10	20	9,00€	
12066	17mm	0,20	10	50	9,00€	
12067	18mm	0,20	10	20	9,50€	
12068	19mm	0,21	10	50	9,50€	
12069	21mm	0,25	10	50	9,50€	
12070	22mm	0,30	10	20	10,50€	

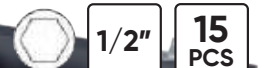

SET DE 12 VASOS DE IMPACTO DE 1/2" HEX PERFIL BAJO

53060 34,90€

10, 11, 12, 13, 14, 15, 16, 17, 18,
19, 20, 21mm (28,2mmL)



1/2"

12
PCS

0,85 5 25 500



28mmL



SET DE 11 VASOS DE IMPACTO DE 1/2"

53744 63,00€

52342 63,00€

10, 11, 12, 13, 14, 16, 17, 19,
21, 22, 24mm (78mmL)

1/2"

11
PCS

2,30 5 10 360



2,05 5 10 360



DESPIECE DISPONIBLE

REF.	mm	Kg	Sub	Pf	€
12061	10mm	0,14	10	100	9,50€
14736	11mm	0,15	5	20	5,00€
12062	12mm	0,15	10	100	9,50€
12063	13mm	0,15	10	50	9,50€
14737	14mm	0,15	5	20	5,00€
12065	16mm	0,30	10	20	9,00€
12066	17mm	0,20	10	50	9,00€
12068	19mm	0,21	10	50	9,50€
12069	21mm	0,25	10	50	9,50€

REF.	mm	Kg	Sub	Pf	€
12070	22mm	0,30	10	20	10,50€
12071	24mm	0,30	10	50	11,00€

SET DE 3 VASOS DE IMPACTO LARGO HEX 1/2"

52969 20,70€



1/2"

3
PCS

0,80 5 20 640



17, 19, 21mm
(78mmL)



SET DE 4 VASOS DE IMPACTO PARA LLANTAS DE ALEACION - 1/2"

53587 44,00€

1/2"

4
PCS

1,05 5 20 -



DESPIECE DISPONIBLE

REF.	mm	Kg	Sub	Pf	€
14172	15mm - SMART	0,20	10	50	8,50€
14173	17mm - MERCEDES	0,20	10	50	9,50€
14177	22mm - OPEL	0,25	10	50	9,50€
14178	21mm - HYUNDAI/KIA	0,25	10	50	9,50€

KIT DE 4 VASOS DE IMPACTO DE 1/2" ESPECIAL LLANTAS DE ALEACION

52338 41,00€



1/2"

4
PCS

1,00 5 20 640



17, 19, 21, 22mm (85mmL)



DESPIECE DISPONIBLE

REF.	mm	Kg	Sub	Pf	€
11314	17mm	0,21	10	100	8,50€
11315	19mm	0,23	10	100	8,50€
11316	21mm	0,26	10	100	8,50€
11628	22mm	0,27	10	50	9,50€

KIT DE 3 VASOS DE IMPACTO DE 1/2" ESPECIAL LLANTAS DE ALEACION

51336 29,30€

17, 19, 21mm
(85mmL)



1/2"

3
PCS

0,85 - 5 700



KIT DE 10 VASOS DE IMPACTO DE 1/2" ESPECIAL EXTRACCIÓN RUEDAS

53988 101,00€

3.00	-	10	120
Kg	Sub	ff	ff

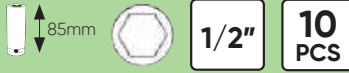

CONTIENE

x7 1/2"	15, 17, 19, 21, 22, 23, 24mm
x1 7/8"	Tesla
x1 17mm	Mercedes
x1 21mm	Hyundai/Kia



KIT DE 12 VASOS DE IMPACTO DE 1/2" HEX ESPECIAL EXTRACCIÓN RUEDAS

52343 52,00€

1.90	-	4	360
Kg	Sub	ff	ff

CONTIENE

x3 85mmL	17, 19, 21mm
x1 42mmL	27mm
x8 38mmL	10, 11, 13, 14, 17, 19, 22, 24mm



SET DE 4 VASOS DE IMPACTO PARA TORNILLOS DE SEGURIDAD 1/2"

53197 46,00€

1.17	5	20	-
Kg	Sub	ff	ff



17, 19, 21, 22mm (82mmL)

BARRAS DE EXTENSIÓN DE IMPACTO 1/2"

53077 62,00€

1.58	-	10	240
Kg	Sub	ff	ff



100, 110, 120, 135, 150 Nm

DESPIECE DISPONIBLE

200NM 13680 15,50€ 0.36 - 50 - - Kg Sub ff ff	175NM 13682 15,50€ 0.32 - 50 - - Kg Sub ff ff	150NM 13684 15,50€ 0.28 - 50 - - Kg Sub ff ff	160NM 13683 15,50€ 0.30 - 50 - - Kg Sub ff ff	135NM 13685 15,50€ 0.25 5 50 1500 Kg Sub ff ff	110NM 13687 15,50€ 0.22 5 50 - Kg Sub ff ff	90NM 13689 15,30€ 0.20 5 50 1500 Kg Sub ff ff
--	--	--	--	---	--	--

BARRAS DE EXTENSIÓN DE IMPACTO 1/2"

12937 9,50€

0.11	10	100	1500
Kg	Sub	ff	ff

50mm



12074 11,50€

0.23	10	60	-
Kg	Sub	ff	ff

125mm



12075 15,50€

0.45	10	50	-
Kg	Sub	ff	ff

250mm

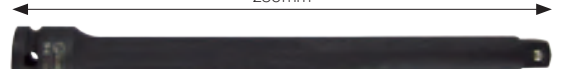

ARTICULACIÓN UNIVERSAL DE IMPACTO 3/4" - 1/2"

11938 47,00€

0.62	6	30	-
Kg	Sub	ff	ff



SET 3 ARTICULACIONES IMPACTO CON DOBLE POSICIÓN (FIJO / ARTICULADO)

53043 53,00€

0.43	5	50	1000
Kg	Sub	ff	ff

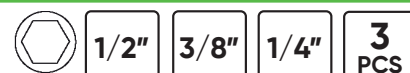

11990 15,30€

0.15	10	100	100
Kg	Sub	ff	ff



SET DE 8 VASOS HEX. 1/2" CON DOBLE POSICIÓN (FIJO / ARTICULADO)

53044 121,00€

2,43 - 8 1000



1/2"

8
PCS

13, 14, 15, 16, 17,
19, 21, 22mm

SET DE 6 VASOS-PUNTAS DE 12 CANTOS DE 1/2"

52546 39,60€

0,80 5 10 720



1/2"

6
PCS

REF.	mm	Kg	Sub	11	€
12931	43mmL	0,08			7,50€
12932	43mmL	0,08			7,50€
12933	43mmL	0,08			8,00€
12934	78mmL	0,08			7,50€
12935	78mmL	0,08			8,00€
12936	78mmL	0,08			8,50€



VASOS PUNTA DE 12 CANTOS INVIOLABLE DE 1/2"

52810 9,00€

0,20 5 100 -



M16



1/2"

75mm



- Vaso de impacto 75 mm de largo y cuadrado de 1/2" para la extracción del tornillo de drenaje con pistola de impacto en transmisiones de vehículos VAG, Porsche, Ford, etc.

52811 9,90€

0,15 5 100 -



M18

- Para la extracción del brazo de dirección en vehículos del grupo VAG.



SET DE 13 PUNTAS DE 1/2" HEXAGONAL Y TORX

52344 197,00€

1,45 - 10 600



1/2"

13
PCS

CONTIENE

	x5 45mmL	5, 6, 8, 10, 12mm
	x8 45mmL	T30, T40, T45, T50, T55, T60, T70, T80

SET DE 8 PUNTAS HEX DE 1/2"

52339 61,00€

1,25 5 10 360



DESPIECE DISPONIBLE

REF.	mm	Kg	Sub	11	€
14004	5mm	0,1	10	240	9,50€
14005	6mm	0,1	10	120	10,50€
14006	7mm	0,1	10	240	9,50€
14007	8mm	0,2	10	240	9,50€
14008	10mm	0,1	10	240	9,50€
14009	12mm	0,1	10	240	9,50€
14010	14mm	0,1	10	120	11,00€
14011	17mm	0,2	10	60	11,00€



1/2"

8
PCS

5, 6, 7, 8, 10, 12, 14,
17mm (78mmL)

SET DE 8 PUNTAS TORX DE 1/2"

52340 58,00€

1,15 5 10 360



DESPIECE DISPONIBLE

REF.	mm	Kg	Sub	11	€
12938	T25	0,08	10	50	10,00€
12939	T30	0,09	10	50	10,00€
12940	T40	0,09	10	50	10,00€
12941	T45	0,09	10	50	10,00€
12942	T50	0,09	10	60	10,00€
12943	T55	0,1	10	50	10,00€
12944	T60	0,12	10	50	10,00€
12945	T70	0,14	10	20	10,50€



1/2"

8
PCS

T25, T30, T40, T45, T50,
T55, T60, T70 (78mmL)

SET DE 6 ADAPTADORES DE IMPACTO

53743 39,70€

0,80	5	20	960

6
PCS

M	F
3/4"	1/2"
1/2"	3/4"
3/8"	1/4"
1/4"	3/8"
1/2"	3/8"
3/8"	1/2"



DESPIECE DISPONIBLE

REF.	mm	Kg	Box	Tray	€
14749	1/4" F - 3/8" M	-	20	100	2,00€
14750	3/8" M - 1/4" F	-	20	100	2,00€
14751	3/8" M - 1/2" F	-	20	100	4,00€
14752	1/2" F - 3/8" M	-	10	100	4,00€

JUEGO DE 2 ADAPTADORES DE IMPACTO 1"-1/2"

52545 177,00€

3,00	1	4	1500

1" 1/2" F - 1" M
1" F - 1" 1/2" M



SET DE 8 VASOS DE IMPACTO LARGOS HEX. 3/4"

53470 176,00€

7,50	-	1	85



3/4" 8
PCS

24, 27, 29, 30, 32, 34, 36, 38mm (90mmL)



SET DE 16 PUNTAS DE IMPACTO 3/4"

51028 163,00€

6,25	-	2	-

3/4" 16
PCS

CONTIENE

	3/4"	x4	E18, E20, E22, E24
	3/4"	x5	T60, T70, T80, T90, T100
	3/4"	x4	H17, H19, H22, H24
	1" - 3/4"	x2	
		x1	4mm



DESPIECE DISPONIBLE

REF.	mm	Kg	Box	Tray	€
14723	H17	0,35	-	10	18,00€
14724	T60	0,30	-	10	18,50€
14725	T70	0,30	-	10	18,50€
14726	T80	0,30	-	10	17,50€



SET DE 6 ADAPTADORES DE IMPACTO

52544 93,00€

2,90	-	4	384

6
PCS 1" 3/4" 1/2"

CONTIENE

1/2"	x2	H x 1" M (50mmL), H x 3/4" M (48mmL)
3/4"	x2	H x 1" M (63mmL), H x 1/2" M (85mmL)
1"	x2	H x 3/4" M (69mmL), H x 1/2" M (70mmL)



DESPIECE DISPONIBLE

REF.	mm	Kg	Box	Tray	€
11962	1/2" H - 3/4" M	0,16	10	100	7,50€
11963	1/2" H - 1" M	0,26	6	54	9,00€
11964	3/4" H - 1/2" M	0,34	6	36	12,50€
11965	3/4" H - 1" M	0,44	6	48	16,00€
11966	1" H - 1/2" M	0,53	6	36	18,00€
11967	1" H - 3/4" M	0,53	4	36	18,00€



SET DE 8 VASOS DE IMPACTO HEXAGONALES 3/4"

52347 158,00€

6,25	-	4	200



3/4" 8
PCS

26, 27, 29, 30, 32, 35, 36, 38mm (90mmL)



SET DE 8 VASOS DE IMPACTO DE 1"

52348 179,00€

5,85	-	2	252



1" 8
PCS

24, 27, 30, 32, 33, 36, 38, 41mm



DESPIECE DISPONIBLE

REF.	mm	Kg	Box	Tray	€
13859	24mm	0,6	6	96	16,00€
13874	27mm	0,6	6	72	17,50€
13875	30mm	0,5	6	18	18,50€
13876	32mm	0,6	6	24	18,50€
13877	33mm	0,6	6	96	18,50€
11153	36mm	0,7	6	18	23,40€
11155	38mm	0,9	6	12	24,40€
11158	41mm	0,95	6	18	28,50€





VASOS DE IMPACTO



1"					
REF.	mm	Kg			€
11153	36mm	0,71	6	18	23,40€
11154	37mm	0,73	6	24	21,70€
11155	38mm	0,74	6	12	24,40€
11156	39mm	0,74	6	24	28,90€
11157	40mm	0,78	6	12	26,60€
11158	41mm	0,81	6	18	28,50€
11159	42mm	0,91	6	18	30,30€
11160	43mm	0,94	6	12	27,00€
11161	44mm	0,93	6	18	32,30€
11162	45mm	0,94	4	8	29,10€
11163	46mm	1,00	4	12	32,70€
11164	47mm	1,02	4	8	30,70€
11165	48mm	1,01	4	8	34,60€
11166	50mm	1,18	4	12	30,90€
11167	51mm	1,18	4	8	38,00€
11168	52mm	1,18	1	10	41,00€
11169	53mm	1,27	4	12	39,20€
11170	54mm	1,33	4	12	40,00€
11171	55mm	1,44	2	8	51,00€
11172	56mm	1,47	4	8	48,00€
11173	57mm	1,44	4	8	47,00€
11174	58mm	1,58	4	8	47,00€
11175	59mm	1,58	4	8	49,00€
11176	60mm	1,62	2	4	56,00€
11177	62mm	1,63	2	4	55,00€
11178	63mm	1,75	-	8	53,00€
11179	65mm	1,87	2	8	65,00€
11180	67mm	1,93	2	8	59,00€
11181	68mm	1,93	2	8	65,00€
11182	70mm	2,09	2	4	73,00€
11183	71mm	3,10	-	6	70,00€
11184	73mm	3,27	-	4	87,00€
11185	75mm	3,34	1	6	97,00€
11186	76mm	3,70	-	5	91,00€
11187	78mm	3,47	-	5	98,00€
11188	80mm	3,69	1	4	103,00€
11189	85mm	3,81	1	4	121,00€
11190	89mm	3,80	-	2	138,00€
11191	90mm	4,29	1	4	149,00€
11192	92mm	4,50	1	2	152,00€
11193	95mm	4,89	-	2	183,00€
11194	100mm	4,36	1	4	176,00€
11621	105mm	7,81	1	2	359,00€
11622	110mm	7,75	1	2	399,00€
11623	115mm	8,21	1	2	489,00€

1/2"					
REF.	mm	Kg			€
14728	10mm	0,10	5	20	3,80€
14729	11mm	0,05	5	20	3,80€
14730	12mm	0,05	5	20	3,80€
14731	13mm	0,10	5	20	3,80€
14732	14mm	0,10	5	20	3,80€
11195	17mm	0,10	10	50	3,70€
11121	19mm	0,10	10	60	4,10€
14733	21mm	0,10	5	20	4,30€
14734	22mm	0,15	5	20	5,40€
11122	24mm	0,14	10	20	5,45€
11123	27mm	0,17	10	50	6,50€
11124	30mm	0,20	10	50	7,65€
11125	32mm	0,22	10	50	8,50€

3/4"					
REF.	mm	Kg			€
11126	19mm	0,25	6	60	11,20€
11127	21mm	0,29	6	24	13,80€
11128	22mm	0,34	6	24	14,10€
11129	24mm	0,32	6	54	14,10€
11130	25mm	0,33	6	24	13,10€
11131	26mm	0,32	6	36	14,10€
11132	27mm	0,35	6	54	13,70€
11133	28mm	0,40	6	12	12,00€
11134	30mm	0,41	6	24	15,00€
11135	32mm	0,44	6	48	17,20€
11136	33mm	0,47	6	12	15,30€
11137	34mm	0,51	6	24	18,20€
11138	35mm	0,49	6	12	18,00€
11139	36mm	0,52	6	24	18,80€
11140	38mm	0,53	6	24	20,40€
11141	40mm	0,54	6	12	18,60€
11142	41mm	0,61	6	12	21,30€
11143	46mm	0,74	6	18	26,40€
11144	50mm	1,00	6	24	33,30€
11145	51mm	1,10	4	12	35,30€
11146	55mm	1,23	4	12	37,30€
11147	57mm	1,23	4	12	41,00€
11148	60mm	1,40	4	12	47,00€
11149	63mm	1,32	4	12	45,00€
11150	65mm	1,50	1	8	55,00€
11151	67mm	1,49	4	12	57,00€
11152	70mm	1,49	4	12	57,00€

1"					
REF.	mm	Kg			€
11624	65mm	2,42	1	2	189,00€
11625	85mm	5,11	1	2	282,00€
12984	105mm	4,8	1	2	379,00€

1/2" 78mmL					
REF.	mm	Kg			€
12061	10mm	0,14	10	100	9,50€
14736	11mm	0,15	5	20	5,00€
12062	12mm	0,15	10	100	9,50€
12063	13mm	0,13	10	50	9,50€
14737	14mm	0,15	5	20	5,00€
12064	15mm	0,17	10	100	9,00€
12065	16mm	0,16	10	20	9,00€
12066	17mm	0,18	10	50	9,00€
12067	18mm	0,23	10	20	9,50€
12068	19mm	0,21	10	50	9,50€
12069	21mm	0,24	10	50	9,50€
12070	22mm	0,28	10	20	10,50€
12071	24mm	0,30	10	50	11,00€
12072	27mm	0,35	10	20	12,00€

3/4" 90mmL					
REF.	mm	Kg			€
13723	19mm	0,41	6	12	18,50€
13724	21mm	0,48	6	12	19,20€
13725	22mm	0,61	6	18	19,20€
13726	24mm	0,56	6	24	19,00€
13727	26mm	0,51	6	18	18,70€
13728	27mm	0,50	6	18	18,50€
13729	29mm	0,71	6	12	22,00€
13730	30mm	0,68	6	24	22,00€
13731	32mm	0,71	6	24	21,60€
13732	33mm	0,78	5	15	23,80€
13733	34mm	0,81	6	18	24,90€
13734	35mm	0,80	6	18	25,70€
13735	36mm	0,81	6	12	25,80€
13736	38mm	0,83	6	18	25,90€

1/2" 78mmL					
REF.	mm	Kg			€
14738	10mm	-	10	100	5,50€
14739	11mm	-	10	100	5,50€
14740	12mm	-	10	100	5,55€
14741	13mm	-	10	100	5,55€
14742	14mm	-	10	100	5,55€
14743	16mm	-	10	100	5,15€
14744	17mm	-	10	50	5,35€
14745	19mm	-	10	50	6,25€
14746	21mm	-	10	50	6,40€
14747	22mm	-	10	50	7,10€
14748	24mm	-	10	50	8,30€
11613	27mm	0,34	10	20	11,00€
11614	30mm	0,42	10	40	13,00€
11615	32mm	0,38	6	24	14,20€
11616	33mm	0,45	6	12	18,10€
11617	34mm	0,40	6	24	18,70€
11618	35mm	0,46	6	18	18,80€
11619	36mm	0,47	6	36	19,50€

1" 90mmL					
REF.	mm	Kg			€
13745	28mm	0,77	6	24	25,20€
13746	30mm	0,95	6	12	25,40€
13747	32mm	0,90	6	12	25,40€
13748	33mm	0,89	6	12	24,90€



UTILLAJES VEHÍCULOS PESADOS

VASO DE BUJE CAMIÓN BPW

52914 223,00€

- Extracción bujes eje trasero BPW.

2,90 - 4 500



120mm 8 CARAS
CUADRADO HEXAGONAL 41mm



VASO DE BUJE CAMIÓN BPW

52915 199,00€

- Extracción bujes eje trasero BPW.

2,90 - 8 1500



111mm OVAL
CUADRADO HEXAGONAL 41mm



VASO DE BUJE CAMIÓN BPW

52916 218,00€

- Extracción bujes eje trasero BPW.

2,57 - 6 1000



109mm 8 CARAS
CUADRADO HEXAGONAL 41mm



VASO EXTRACCIÓN EJES CAMIÓN BPW

52917 122,00€

- Extracción bujes tractoras 6,5-9 TON.

1,05 - 10 1000



65mm OVAL
CUADRADO HEXAGONAL 36mm



VASO TAPACUBOS TRASERO EJE BPW

52918 146,00€

- Extracción bujes eje trasero BPW.

2,05 - 8 1500



95mm
CUADRADO 3/4"



VASO TUERCA RUEDA BPW

52919 181,00€

- Extracción eje trasero BPW.

2,65 - 8 1500



110mm 8 CARAS
CUADRADO 3/4"



VASO EXTRACCIÓN TUERCA COJINETES EJE BPW

52920 155,00€

- Para extraer la tuerca anterior a los cojinetes en ejes BPW 12 TON.

1,35 - 10 1000



80mm
CUADRADO 3/4"



VASO EXTRACCIÓN TUERCA COJINETES EJE TRASERO BPW

52921 117,00€

- Para extraer la tuerca anterior a los cojinetes en ejes BPW 6,5-9 TON.

0,73 - 10 500



65mm
CUADRADO 3/4"



VASO EXTRACCIÓN TUERCA EJES BPW

52922 180,00€

- En ejes BPW 16 TON.

2,10 - 10 1000



85mm 6 CARAS
CUADRADO 3/4"



VASO EXTRACCIÓN TUERCA DE SUSPENSIÓN SCANIA

52923 59,00€

0,55 - 12 1500



28x37mm
CUADRADO 3/4"



VASO EXTRACCIÓN EJE SUSPENSIÓN SCANIA

52924 52,00€

0,75	-	24	1500
Kg	SUB	ff	ff

34x46mm

CUADRADO 3/4"



VASO EXTRACCIÓN TUERCA SCANIA

52925 176,00€

1,80	-	10	1500
Kg	SUB	ff	ff

80mm

8 CARAS

CUADRADO HEXAGONAL 41mm

- Extracción tuerca ejes delanteros.



VASO EXTRACCIÓN RUEDA TRASERA SCANIA

52926 201,00€

2,75	-	8	1500
Kg	SUB	ff	ff

100mm

8 CARAS

CUADRADO 3/4"

- Extracción tuerca ejes traseros.



VASO EXTRACCIÓN TUERCA BALLESTA SCANIA

52927 59,00€

0,78	-	20	1000
Kg	SUB	ff	ff

34x56mm

CUADRADO 3/4"



VASO DE BUJE SCANIA

52928 172,00€

1,90	-	10	1500
Kg	SUB	ff	ff

80mm

8 CARAS

CUADRADO 3/4"

- Extracción bujes de eje delantero.



VASO TUERCA RUEDA SCANIA

52929 185,00€

2,68	-	6	1500
Kg	SUB	ff	ff

95mm

8 CARAS

CUADRADO 3/4"

- Extracción tuerca buje tercer eje en camiones de 10 ejes.



ÚTIL INSTALACIÓN RETÉN TRASERO ACEITE DEL CIGÜEÑAL SCANIA

52930 117,00€

2,86	-	4	1500
Kg	SUB	ff	ff

SCANIA 310/320

RETÉN 0366303-R



VASO CAMIÓN SCANIA ROTACIÓN ÁRBOL DE LEVAS

52931 45,00€

0,23	-	10	500
Kg	SUB	ff	ff

CUADRADO 1/2"



VASO PARA VÁLVULA DE INYECCIÓN ELECTROMAGNÉTICA SCANIA

52932 45,00€

0,47	-	20	1500
Kg	SUB	ff	ff

Ø 38mm

CUADRADO 1/2"



VASO 8 ALMENAS SCANIA

52933 194,00€

3,15	-	6	504
Kg	SUB	ff	ff

SCANIA 420

8 ALMENAS

CUADRADO 3/4"

Ø Exterior: 11,6cm
Ø Interior: 10cm



UTILLAJES VEHÍCULOS PESADOS

VASO DE BUJE PARA IVECO

53430 286,00€

- Se utiliza con llave o vaso de 36mm.

2,95 - 8 280
Kg SUB ff

Ø Exterior: 134mm
Ø Interior: 110,5mm
IVECO
12 CARAS
118x134mm



VASO TUERCA PRISIONERA CAMIÓN BENZ/MAN

52935 94,00€

0,91 - 10 1000
Kg SUB ff

60mm CUADRADO 3/4"



VASO EJE TRASERO CAMIÓN BENZ/MAN

52936 199,00€

- Útiles en furgones.

1,58 - 10 1500
Kg SUB ff

80-95mm 6 ALMENAS
CUADRADO 3/4"



VASO EXTRACCIÓN BUJE TRASERO CAMIÓN BENZ/MAN

52937 265,00€

- Extracción bujes eje trasero.

3,05 - 6 1500
Kg SUB ff

95-115mm 6 ALMENAS
CUADRADO 3/4"



VASO EXTRACCIÓN TUERCA DIRECCIÓN CAMIÓN BENZ/MAN

52938 199,00€

- Para la extracción de la tuerca del eje de dirección.

3,22 - 6 1500
Kg SUB ff

100mm 6 ALMENAS
CUADRADO 3/4"



VASO EXTRACCIÓN VÁLVULA INYECCIÓN MAN / BENZ / SCANIA

52939 28,00€

0,20 - 30 1500
Kg SUB ff

22-28mm 4 ALMENAS
CUADRADO 3/4"
DIESEL



VASO CAMIÓN BENZ / MAN PARA TUERCA DIFERENCIAL TRASERO

52940 235,00€

4,34 - 4 1500
Kg SUB ff

101mm 6 ALMENAS
CUADRADO 3/4"



ÚTIL ROTACIÓN VOLANTE DE MOTOR BENZ / MAN 2 ENGRANAJES

52941 70,00€

- Para Benz de 6, 8 y 10 cilindros.
- Para Man de 12 cilindros.

0,54 - 20 1500
Kg SUB ff

CUADRADO 1/2"



ÚTIL ROTACIÓN VOLANTE DE MOTOR BENZ / MAN 3 ENGRANAJES

52942 105,00€

- Para Mercedes Actros y Atego.
- Para Man de 5,6 y 8 cilindros.

0,87 - 20 960
Kg SUB ff

CUADRADO 1/2"



ÚTIL CAMIÓN ROTACIÓN VOLANTE DE MOTOR MAN

52943 75,00€

0,49 - 30 1500
Kg SUB ff

CUADRADO 1/2"



VASO EXTRACCIÓN TUERCA COJINETES EJE BPW

52944 110,00€

1,00 - 20 1500
Kg SUB ff

30mm
CUADRADO HEXAGONAL 19mm



VASO EXTRACCIÓN TUERCA COJINETES EJE TRASERO BPW

52945 281,00€

2,74 - 24 960
Kg SUB ff

39mm
CUADRADO HEXAGONAL 26mm



VASO TUERCA PRISIONERA CAMIÓN BENZ/MAN

52934 102,00€

1,05 - 12 1000
Kg SUB ff

56mm
CUADRADO 3/4"





CARROCERÍA

- 160 PARA CHAPISTA
- 161 PARA FAROS
- 162 CASCOS SOLDADURA / SETS DE PALANCAS
- 163 JUEGO PARA ABRIR COCHES
/ SUSTITUCIÓN DE LUNAS
- 164 MORDAZAS
- 166 PISTOLAS DE SILICONA / VENTOSAS
- 167 CINTAS DE SUJECIÓN / CARRO Y ALMACENAJE
- 168 CABALLETES / SOPORTES
- 170 MANTENIMIENTO DEL VEHÍCULO
/EXPOSITORES
- 171 COLCHONETAS
- 172 PLATAFORMAS DE ALUMINIO

KIT PDR PARA REPARAR ABOLLADURAS

53224 142,00€

32
PCS

AUDI

3,90	-	5	35
Kg	sub	ff	

- 1 Pistola de pegamento (220-240V ~, 50Hz, 40W).
- 1 Martillo deslizando para la extracción de abolladuras profundas.
- 1 Levantador de abolladuras para la extracción de abolladuras ligeras en superficies planas.
- 1 Limpiador de pegamento.
- 1 Rascador para la extracción suave de las lengüetas para pegamento.
- 8 Barras de pegamento negro (11 x 200mm).
- 19 Lengüetas para pegamento en varios tamaños y formas.



DESPIECE DISPONIBLE

REF.	DESCRIPCIÓN	Kg	sub	ff	€
13842	Bolsa de 5 discos azules	0,15	10	100	8,50€
13843	Bolsa de 4 discos amarillos	0,1	10	100	7,00€
13844	Bolsa de 10 discos rojos	0,3	10	50	9,00€
13845	Bolsa de 5 barras de pegamento	0,02	10	100	8,00€



PANTALLA PARA INSPECCIÓN DE ABOLLADURAS

53486 29,30€

0,30	10	40	160
Kg	sub	ff	

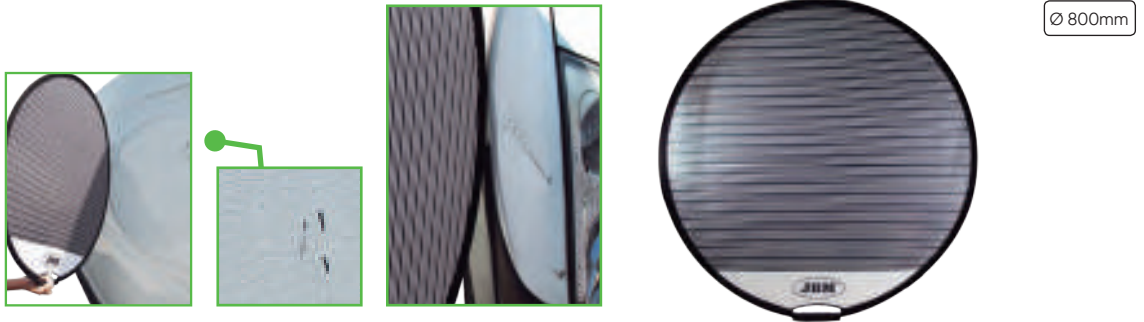

Ø 800mm

CONJUNTO DE MATRICES

Permiten marcar numérica o alfabéticamente todo tipo de superficies metálicas mediante prensado o golpeo. El acabado redondeado de su extremo evita la aparición de grietas o roturas en la superficie trabajada.

LETRAS Y NÚMEROS

52422 24,70€

0,82	3	6	540
Kg	sub	ff	



5mm A-Z & 0-9

53119 52,00€

194	3	6	504	36 PCS	5/16"
Kg	sub	ff			



8mm A-Z & 0-9

NÚMEROS

52882 14,00€

0,30	10	60	1500	1/4"	9 PCS
Kg	sub	ff			



6mm 0-8

KIT DE TASES PARA CHAPISTA

52876 182,00€

3,13	-	6	84
Kg	sub	ff	



RECUBIERTOS DE PLÁSTICO

REF.	DESCRIPCIÓN	Kg	sub	ff	€
12959	Tas cara plana y cara oval	0,29	-	25 99	27,80€
12955	Tas de rail	0,31	-	25 99	27,80€
12956	Tas con cara oval	0,37	5	25 99	27,80€
12958	Tas mango con cuña	0,41	-	25 -	27,80€
12959	Tas en coma	0,3	5	25 99	27,80€
12960	Tas de tacón	0,18	-	25 1500	27,80€
12961	Tas de coma con mango	0,34	-	25 -	27,80€

DESPIECE DISPONIBLE

KIT DE RESTAURACIÓN DE FAROS

53673 80,00€

2,00	-	10	80
Kg	sub	ff	ff

- Polímero líquido que al evaporizarse permite restaurar los faros que hayan sido dañados debido a inclemencias climatológicas, proporcionando un brillo y acabado perfectos.

- Incluye:
Líquido especial de lijado (100ml).
6 papeles de lija.
Cinta de pintor.
Placa de lijador.
Embudo de plástico.
Tapón especial para la salida de gas.
Tapón y tubo de plástico para salida de gas.
Taza vaporizadora.
Enchufe toma de corriente.
Enchufe toma de mechero.



15375 28,00€

0,80	4	24	600
Kg	sub	ff	ff

BOTELLA DE LÍQUIDO 600ml

Polímero líquido que al evaporizarse permite restaurar los faros que hayan sido dañados debido a inclemencias climatológicas, proporcionando un brillo y acabado perfectos.



BRILLO Y ACABADO PERFECTOS

DESPIECE DISPONIBLE

REF.	DESCRIPCIÓN	Kg	sub	ff	ff	€
14564	Set de 6 papeles de lija	0,10	10	100		9,20€
14565	Enchufe toma corriente	0,20	10	50		26,70€
14566	Enchufe toma mechero	0,05	10	100		16,70€
14567	Taza vaporizadora	0,15	10	20		38,00€
14568	Tapón de plástico curvado para salida de gas	0,1	10	200		9,20€
14569	Tapón y tubo de plástico para salida de gas	0,1	10	200		9,20€
14570	Embudo de plástico	0,01	10	200		4,05€
14571	Placa de lijador	0,05	-	100		9,20€
14573	Cinta de pintor	0,70	10	100		4,05€
15375	Botella de líquido 600ml	0,01	4	24		28,00€



BOLSAS DE 10 PAPELES DE LIJA

GRANO	REF.	DESCRIPCIÓN	Kg	sub	ff	ff	€
GRANO 180	14710		0,25				3,50€
GRANO 280	14711		0,20				3,75€
GRANO 360	14712		0,20				4,00€
GRANO 600	14713		0,15				4,25€
GRANO 800	14714		0,15				4,50€
GRANO 1200	14715		0,10				4,75€

SET MARTILLOS ESPECIAL PARA CHAPA

51131 61,00€

5,00	-	5	100
Kg	sub	ff	ff



7 PCS

DESPIECE DISPONIBLE

REF.	DESCRIPCIÓN	Kg	sub	ff	ff	€
11541	Martillo de boca plana	0,43	5	25		11,00€
11542	Martillo plano peña	0,38	5	25		11,00€
11543	Martillo plano cónico	0,42	5	25		11,00€
11544	Tas de tacón	0,69	5	25		7,00€
11545	Tas de aleta	0,79	5	25		11,00€
11546	Tas dos cantos romo	0,81	5	25		12,00€
11547	Tas de cuña en 8 o carril	0,81	5	25		12,00€

KIT DE PULIDO DE FAROS

53626 18,00€

0,30	-	12	576
Kg	sub	ff	ff

- Diseñado para restaurar la claridad de las lentes de los faros que se han vuelto amarillentas, turbias o nebulosas.
- Mejora el rendimiento de las lentes de los faros.
- Tres pasos sencillos: lijar, pulir y proteger.
- Restaura los faros delanteros, las luces traseras, los faros antiniebla o las luces direccionales.
- Este kit está hecho para restaurar 2 faros.



- Contenido del kit:
2x P800 Disco para lijar.
2x P1200 Disco para lijar.
2x P2000 Disco para lijar.
1x 85g Pasta Pulidora.
2x 3,0ml Líquido protector UV.
1x Cinta adhesiva.
1x Disco Pulidor de Lana.
1x Disco Esponja Blanco.
1x Almohadilla de soporte M10 Rosca.
2x Adaptador (3/8" & 1/4").



EN EXPOSITOR DE 12 UNIDADES

DESPIECE DISPONIBLE

REF.	DESCRIPCIÓN	Kg	sub	ff	ff	€
14286	Esponja naranja de poliéster	1,95	-	200		2,99€
14287	Esponja densa	2,30	-	200		2,99€
14288	Esponja de lana	2,30	10	200		6,00€
14289	Disco de velcro	7,40	-	200		6,10€
53646	Kit pulidora neumática de 3"	8,95	5	10		62,00€



SERIE ESPECIAL PULIDO: PULIDORA + KIT FAROS X12

SERIE262 199,00€



x1

x12

53646

IVA no incluido

CASCO PARA SOLDADURA CON REGULADOR MANUAL

53414 49,00€

0.85	-	6	36
Kg	Sub	ff	ff



CASCO PARA SOLDADURA CON REGULADOR DIGITAL

53415 188,00€

0.95	-	4	40
Kg	Sub	ff	ff



ESTUCHE DE 4 PALANCAS EXTRALARGAS

52977 137,00€

8.50	-	1	42
Kg	Sub	ff	ff

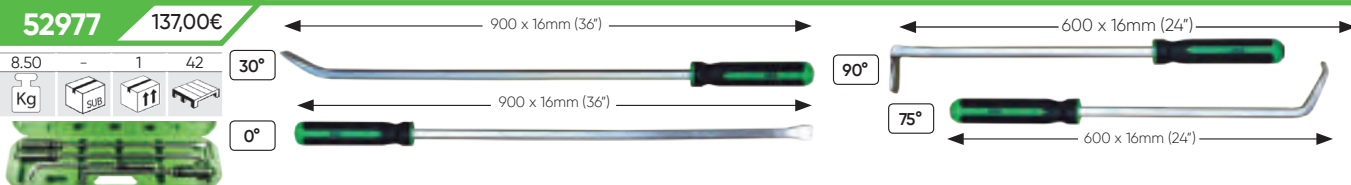

SET 27 PALANCAS DE NYLON

52788 39,00€

1.18	27	10	170
Kg	Sub	ff	ff

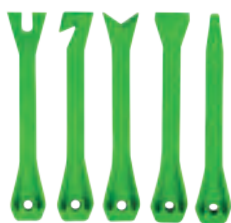

27 PCS

- Con diferentes curvaturas y terminaciones, facilitando el trabajo en lugares de difícil acceso, tanto en interiores como en exteriores de los vehículos.

SET DE 5 PALANCAS DE NYLON

50901 16,00€

0.30	5	20	240
Kg	Sub	ff	ff



- Universal
- Especial zonas estrechas
- Con tirador
- Uso práctico
- Tapicerías

- Medidas:
6 x 160mm
63 x 175 mm
30 x 200mm
20 x 180mm
20 x 215mm



SET DE 4 PALANCAS DE NYLON TIPO CUCHILLA

51832 18,00€

0.50	12	24	192
Kg	Sub	ff	ff

19x273, 22x273,
25x273, 38x273mm



SET DE 5 PALANCAS DE METAL

50903 30,80€

1.90	4	8	200
Kg	Sub	ff	ff

60, 43, 38,
28, 18cm

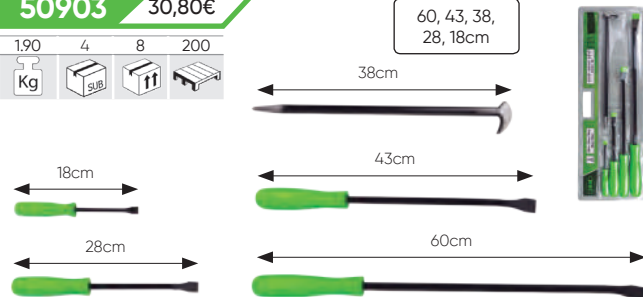

SET DE 2 PALANCAS DE METAL

52026 31,80€

2.04	5	10	240
Kg	Sub	ff	ff

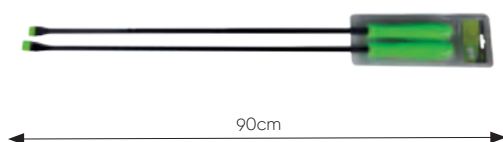

PALANCA EUROPEA CON GANCHO

51360 8,05€

0.80	5	20	900
Kg	Sub	ff	ff

18" x 5/8

51361 9,80€

1.46	5	10	500
Kg	Sub	ff	ff

24" x 3/4

FABRICADAS EN ACERO



SET DE 2 PALANCASEXTRACCIÓN GRAPAS

52851 9,65€

0,35	6	60	600
Kg	Sub	ff	ff



SET DE 6 PALANCAS

53110 27,30€

1,42	6	12	168
Kg	Sub	ff	ff

5"x8.5 / 5"x10.3
5"x4.5 / 15"x8.5
15"x10.3 / 15"x4.5mm

6
PCS

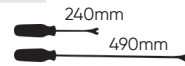

JUEGO DE ÚTILES PARA ABRIR COCHES

53230 19,70€

0,65	6	24	288
Kg	Sub	ff	ff

UNIVERSAL **8**
PCS

- Juego de útiles especial para abrir vehículos sin llave.
- Compuesto de cuñas plásticas, palancas y ganchos curvos.
- Contiene llave universal para tapas de depósito de combustible.
- Para uso en talleres y asistencias.

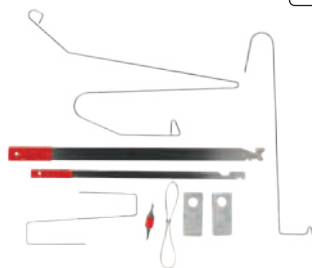

SET DE 4 ALMOHADILLAS HINCHABLES

52077 29,50€

40-50mm

0,35	5	40	400
Kg	Sub	ff	ff

- Introduciéndolas entre el cristal y el marco de la puerta, permiten abrir el vehículo fácilmente y sin dañarlo.

- Contiene:
Almohadilla de 16x16cm
Almohadilla de 32x12cm
Almohadilla de 19x6cm
Almohadilla de 18x4,5cm
Bomba de mano

- Presión máxima soportada: 100kg.



PARA REF. 53232

CABLE PARA EXTRACCIÓN DE LUNAS

13813 7,00€

0,10	10	60	1200
Kg	Sub	ff	ff



ÚTILES DE EXTRACCIÓN DE LUNAS

13814 11,00€

0,20	10	60	1080
Kg	Sub	ff	ff



HERRAMIENTAS PARA SUSTITUCIÓN DE LUNAS

53232 39,00€

1,15	-	10	180
Kg	Sub	ff	ff

- Contiene:
1x útil extractor de molduras.
1x palanca para extraer la goma.
1x gancho extractor.

- 1x 1.8m de alambre de corte.
2x mangos para el alambre de corte.
1x pasa-cables.



ESCUADRA MAGNÉTICA 45°, 90°, 135°

54111 4,75€

0,35	10	40	1680
Kg	Sub	ff	ff

75mm

54113 7,65€

0,60	10	20	1100
Kg	Sub	ff	ff

100mm



53545 35,70€

0,74	5	20	600
Kg	Sub	ff	ff

8, 10, 12, 13, 14mm

Cr-V BMW, FORD, OPEL, VAG, VAUXHALL

- Permite ajustar el cable de freno de mano en BMW, FORD, OPEL, VAG y VAUXHALL.
- Útil para bisagras de puertas, parachoques y luces traseras entre otros.

5
PCS **3/8"**

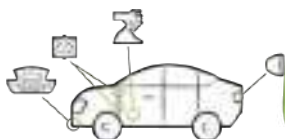

IVA no incluido

JBM www.jbmcamp.com

163

MORDAZAS

0,90	10	20	300
Kg	sub	ff	ff

RECTA

53675 0,75 Kg
50,00€

CURVA

53676 0,85 Kg
44,00€

PLETINA ARTICULADA

53677 0,90 Kg
55,00€

CURVA LARGA

53678 0,90 Kg
52,00€

10"

REF	←	→
53675	250mm	70mm
53676	250mm	90mm
53677	250mm	80mm
53678	300mm	105mm



EN EXPOSITOR DE 10 UNIDADES

KIT DE 3 ALICATES DE MORDAZA EXTRALARGOS

52982 53,00€

1,60	4	8	384
Kg	sub	ff	ff

37cm: punta recta
36cm: ángulo de 45°
34cm: ángulo de 90°

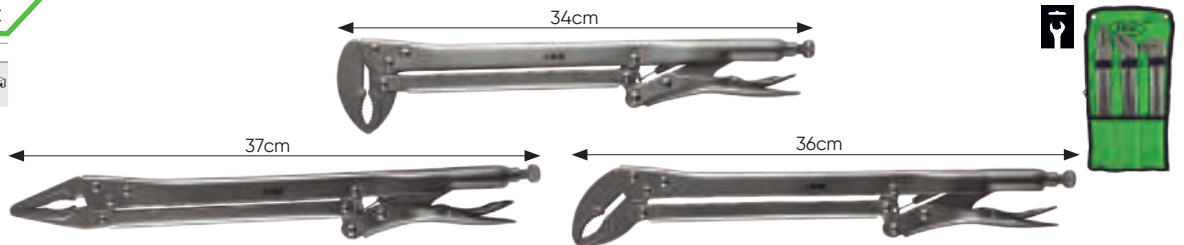

ALICATE MORDAZA PRESIÓN

50577 12,60€

0,53	5	40	-
Kg	sub	ff	ff

CrV 280mm



ALICATE PICO DE LORO CURVADO

52386 23,60€

0,44	10	50	1500
Kg	sub	ff	ff

52386
LISO



52387
DENTADO



52387 24,50€

0,44	10	50	1000
Kg	sub	ff	ff

CrMo

215mm

- Agarre a 6 medidas distintas de tuerca / tornillo hexagonal

JUEGO DE 6 ALICATES MORDAZA

52385 251,00€

3,72	-	6	120
Kg	sub	ff	ff



TIPO W 195mm

14103 32,40€



TIPO T 215mm

14104 32,40€



TIPO L 225mm

14105 32,40€



TIPO J 210mm

14106 32,40€



TIPO LL 195mm

14107 32,40€



TIPO JJ 195mm

14108 32,40€



MORDAZA BLOQUEO

52505 20,80€

0,27	36	72	2160
Kg	sub	ff	ff

Presentación en caja

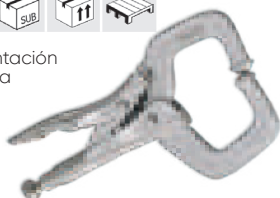

170mm

CrMo

0-40mm

MORDAZA BLOQUEO CON PLETINA

52506 16,00€

0,28	36	72	2160
Kg	sub	ff	ff

Presentación en caja



170mm

CrV

0-50mm

MORDAZA SOLDADURA CON PLETINA

52512 50,00€

1,31	-	20	280
Kg	sub	ff	ff

Presentación en caja



440mm

CrMo

0-210mm

MORDAZA DE SOLDADURA "18"

52511 42,00€ 440mm

1,31 - 20 280

Kg SUB ff

CrMo

0-225mm

- Presentación en caja



MORDAZA BOCA PLANA

52507 30,10€ 250mm

0,77 5 30 420

Kg SUB ff

CrMo

0-80mm

- Presentación en caja



MORDAZA DOBLE PATA

52504 27,60€ 225mm

1,14 - 30 480

Kg SUB ff

CrMo

0-60mm

- Presentación en caja



MORDAZA DE SOLDADURA CON PLETINA

52503 32,50€ 280mm

0,85 10 30 540

Kg SUB ff

CrMo

0-105mm



MORDAZA ESPECIAL SOLDADURA

52390 35,20€ 250mm

0,50 5 40 640

Kg SUB ff

CrMo



MORDAZA DE SOLDADURA

52502 31,40€ 280mm

0,84 10 30 540

Kg SUB ff

CrMo

0-110mm



MORDAZA PINZA

52477 70,00€ 2T

2,65 - 6 1500

Kg SUB ff

0-60mm



MORDAZA 90°

52478 49,00€ 5T

2,90 - 10 1500

Kg SUB ff

0-20mm



MINI MORDAZA PLANA 90°

52479 24,70€ 3T

1,18 - 30 1500

Kg SUB ff

0-20mm



MORDAZA ARGOLLA

52474 68,00€ 6T

3,49 - 5 1500

Kg SUB ff

0-20mm



MORDAZA PLANA

52475 62,00€ 3T

3,60 - 10 1500

Kg SUB ff

0-25mm



MORDAZA CUADRADA

52476 50,00€ 5T

3,10 - 10 1500

Kg SUB ff

0-25mm



MINI MORDAZA CUADRADA 90°

52480 44,00€ 3T

2,00 - 10 1500

Kg SUB ff

0-25mm



MORDAZA CUADRADA

52481 52,00€ 3T

2,05 - 9 1500

Kg SUB ff

0-20mm

Ancho punta 4x1,5mm



MORDAZA PLANA 45°

52482 44,00€ 5T

2,13 - 8 1500

Kg SUB ff

0-10mm



MORDAZA PLANA MINI 5T

52483 41,00€ 3T

2,02 - 12 1500

Kg SUB ff

0-10mm



MORDAZA PINZA

52487 63,00€ 5T

2,27 - 7 1000

Kg SUB ff

0-20mm



UNIÓN CADENAS

52484 66,00€ 3T

1,19 - 11 1500

Kg SUB ff

0-110mm



UNIÓN GANCHOS

52485 51,00€ 4T

1,17 - 30 1000

Kg SUB ff

0-90mm



UNIÓN CADENA GANCHO

52486 62,00€ 3T

1,21 - 11 1500

Kg SUB ff

0-110mm



PISTOLA DE SILICONA PROFESIONAL

52533 10,00€

0.74	12	24	144
Kg	Sub	ff	ff



9"

300ml



PISTOLA DE SILICONA NEUMÁTICA

53567 43,00€

1.05	-	10	180
Kg	Sub	ff	ff

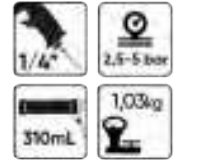

- Presión de trabajo: 2,5-5 BAR.
- Entrada de aire: 1/4".
- Capacidad del cartucho: 310ml.

310ml



HERRAMIENTA DE CALAFATEO DE SILICONA

54017 12,00€

4.60	5	20	240
Kg	Sub	ff	ff

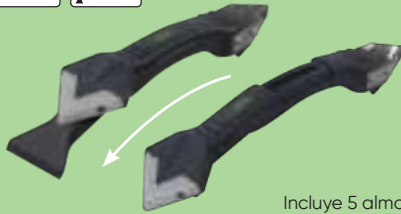

Esta herramienta puede ayudarle a reparar la brecha y limpiar el pegamento residual, mejorar la calidad de aglutinación y el sentido estético de la superficie.

- El raspador de acero inoxidable elimina el pegamento viejo y persistente.
- La paleta de silicona elimina las protuberancias y abolladuras de la superficie
- Es una buena herramienta para alisar las líneas de sellado, las líneas de calafateo.

Incluye 5 almohadillas de silicona reemplazables (3R, 6R, 10R, 13R, 17R radio)

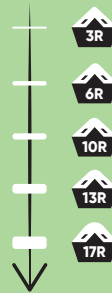

Se puede utilizar para la cocina, el baño, las ventanas, juntas del fregadero etc.

SET DE 2 MINI VENTOSAS

52295 6,50€

0.15	10	100	1200
Kg	Sub	ff	ff

5KG

Ø 60mm



VENTOSA DE EXTRACCIÓN CON MANGO

52589 13,00€

0.28	10	40	640
Kg	Sub	ff	ff



8KG

Ø 70mm

VENTOSAS

UNITARIA

52262 7,50€

0.31	12	48	384
Kg	Sub	ff	ff

40KG

Ø 115mm



DOBLE

52263 13,50€

0.59	6	24	192
Kg	Sub	ff	ff

70KG

Ø 115mm



TRIPLE

52264 18,60€

0.92	6	10	100
Kg	Sub	ff	ff

100 KG

Ø 115mm



CUÁDRUPLE

52265 30,50€

1.24	-	10	100
Kg	Sub	ff	ff

120 KG

Ø 115mm



VENTOSA DOBLE ARTICULADA

52765 21,70€

0.72	5	20	80
Kg	Sub	ff	ff

100 KG

Ø 115mm

- Destinada a operaciones de mantenimiento, instalación y desinstalación de partes del vehículo, tanto de chapa como de cristal.
- De fácil manejo y adaptable a las posibles curvaturas de la superficie.



CONJUNTO DE VENTOSAS Y CORREA CON TRINQUETE

52998 48,00€

2.03	-	8	112
Kg	Sub	ff	ff

80 KG

Ø 120mm



5m x 25mm

CINTA DE SUJECIÓN CON TENSOR

52321 8,80€

0,35 5 20 1200

Kg SUB 1f 1p

5m x 25mm

52327 12,00€

0,46 5 20 1000

Kg SUB 1f 1p

8m x 25mm



CARRO PORTA PIEZAS - PARABRISAS Y CAPÓ

53983 215,00€ - Disponible para parabrisas, chapas metales, capós, puertas,...etc.

19,40 - 1 35

Kg SUB 1f 1p

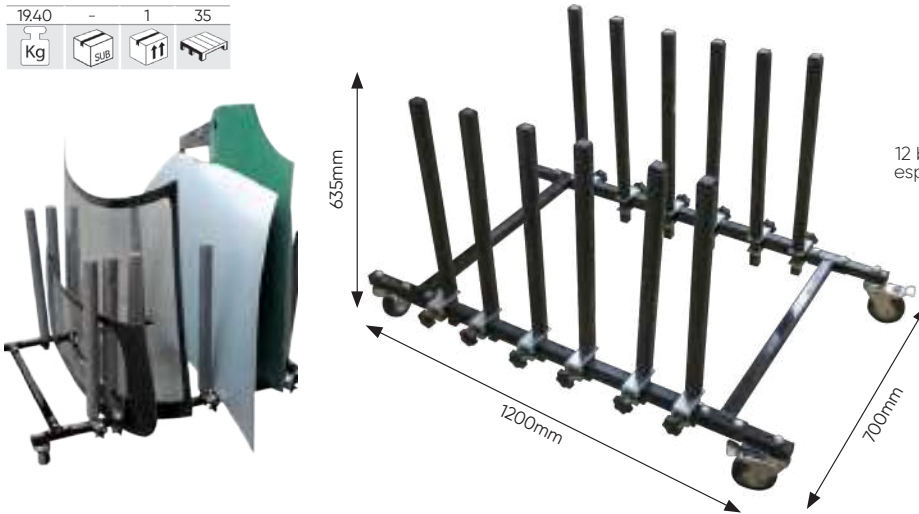

Ruedas de PU de 4 x 4 pulgadas (dos giratorias con freno)

CARRO PARA ALMACENAJE DE PIEZAS

53125 477,00€

51,00 - 1 12

Kg SUB 1f 1p

1.800mm 895mm 585mm

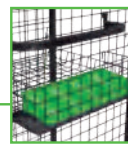

4x INCLUIDOS

CABALLETE UNIVERSAL TELESCÓPICO

53124 287,00€

21,10 - 1 11

Kg SUB 1f 1p



MEDIDAS ALTO

↑ 1.320mm
↓ 840mm

MEDIDAS LARGO

↑ 1.380mm
↓ 225mm

CARRO TRANSPORTADOR ESPECIAL PLANCHA

50923 454,00€

36,40 - 1 18

Kg SUB 1f 1p

480mm 1.300mm 800mm



- Separación de 0 a 110cm.



RUEDA PARA REF. 50923

12022 33,70€



CABALLETE PARA LUNAS DE COCHE

53080

99,00€

1,130mm

990mm

7.87 Kg 1 28

MEDIDAS PLEGADO

70 KG

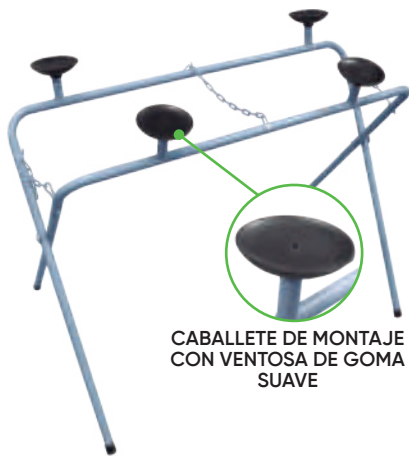

CABALLETE DE MONTAJE CON VENTOSA DE GOMA SUAVE

CABALLETE PLEGABLE

52749

79,00€

80mm

58mm

6.25 Kg 1 31

220 KG



ESPUMA DE RECAMBIO PARA REF. 52749

11959

10,50€

0.08 Kg 100

CABALLETE EN "X"

53079

89,00€

6.77 Kg 1 44

100 KG

MEDIDAS DESPLEGADO

660mm

600mm

870mm

MEDIDAS PLEGADO

1140mm

600mm

300mm

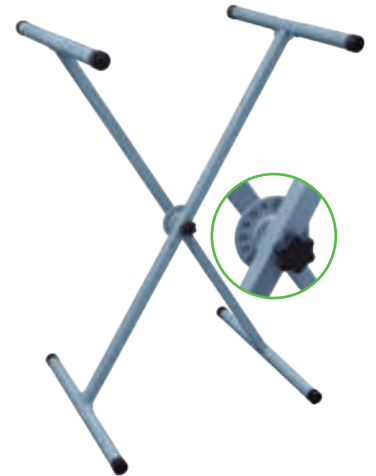

SOPORTE PARA PARACHOQUES

53736

98,00€

8.10 Kg 1 44

- Ideal para la sujeción de parachoques, para pintarlos y repararlos con mayor comodidad.
- Anchura ajustable: 75 Cm -160cm
- Altura máxima: 148cm



ANCHURA AJUSTABLE PERMITE QUE EL SOPORTE SEA ADECUADO PARA SOSTENER VARIOS TIPOS Y ESTILOS DE PARACHOQUES



ACERO

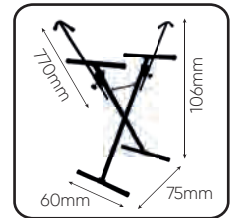

53685

310,00€

14.50 Kg 1 14

1,110mm

760mm

1,340mm

- Sostiene cualquier parachoques sin tocar la superficie pintada.
- Facilita y agiliza las reparaciones y pinturas.
- Giro en 90 grados permite acceder fácilmente a todas la superficie.
- Cinco posiciones distintas de bloqueo.
- Cuatro ruedas de calidad industrial, con bloqueo total para la estabilidad.



AJUSTE DE LOS BRAZOS DE APOYO DE 134 - 198cm

ACERO CON RECUBRIMIENTO DE POLVO

4 RUEDAS DE 4 PULGADAS (DOS GIRATORIAS CON FRENO)

SOPORTE PARA PINTURA AJUSTABLE

53134 144,00€

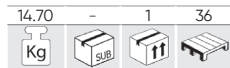

- 6 ganchos para sujetar piezas para pintar o secar.
- Marco ajustable que se extiende de 127cm a 203cm.

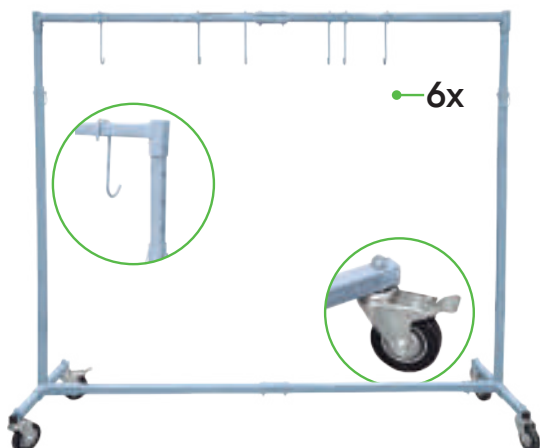

SOPORTE BASCULANTE PARA PINTURA

53126 243,00€



- Ideal para puertas, capós, parachoques, aletas, spoilers etc.

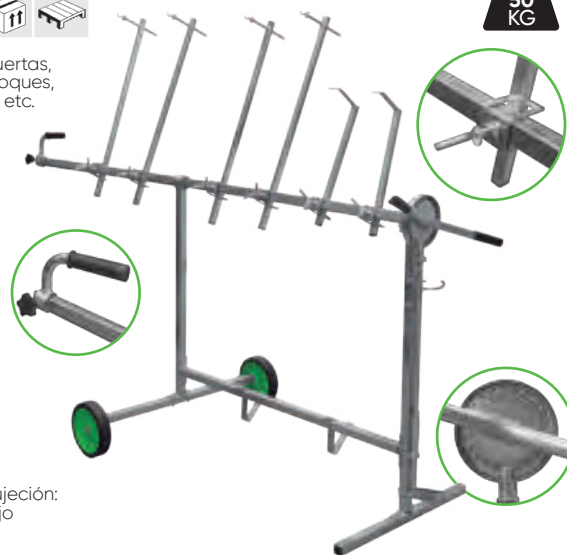

- 6 brazos de sujeción: 4 con gancho fijo 2 con agujero

PORTABOBINA DE PAPEL PARA PARED Y SOBREMESA

53922 29,00€



- Material: acero inoxidable
- Rollo: Ancho máx. de 38 cm.
- Sierra de plástico ABS gris.
- Montaje con tornillo y

tuercas de acero inoxidable.

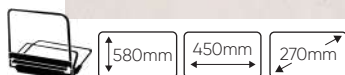

PORTABOBINA DE PAPEL

53921 39,00€

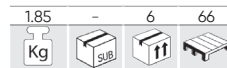

PAPEL NO INCLUIDO



- Material: Acero inoxidable.
- Rollo: Max. ancho 38 cm.
- Sierra de plástico ABS.



ROLLO DE FUNDAS DE PROTECCIÓN

MODELO CUIDAMOS / SIN FALDÓN

51978 84,00€



25mc 250 u.



MODELO DIBUJO ANÓNIMO / SIN FALDÓN

52244 84,00€



25mc 250 u.



25 MICRAS DE GROSOR

SET DE EXPOSITOR + MATERIAL DE CUIDADO DEL VEHÍCULO

INCLUYE REF.: 52065, 52244, 52057, 52058

50403 98,00€



INCLUYE REF.: 51985, 52244, 52057, 52058, 50409

50410 168,00€



INCLUYE REF.: 51985, 51978, 52057, 52058, 50409

50400 168,00€



EXPOSITOR PARED DE BOBINA CUBREASIENTO, ROLLO VOLANTE Y POSAPIES

53705 80,00€

51985 84,00€

500mm 730mm 200mm

4,90 - 1 28
Kg SUB IT

4,85 - 1 28
Kg SUB IT

- Soporte funda posapiés.
- Soporte funda asiento.
- Soporte mango film cubrevolante.



EXPOSITOR PARED DE BOBINA CUBREASIENTOS

52065 45,00€

ROLLO DE FILM CUBREVOLANTE

2,19 - 1 77
Kg SUB IT

FILM

52057 6,80€

- Largo: 200m
- Anchura: 12,5cm
- Espesor: 23mc

0,62 - 24 672
Kg SUB IT

MANGO

52058 4,50€

0,06 - 125 2500
Kg SUB IT

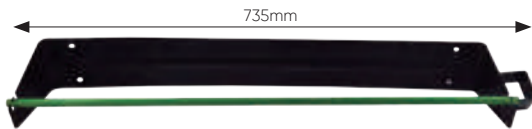

FUNDA POSAPIÉS ANÓNIMA EN PAPEL

50409 26,00€

UDS PACK

440mm 430mm

3,54 - 1 160
Kg SUB IT

250 UDS

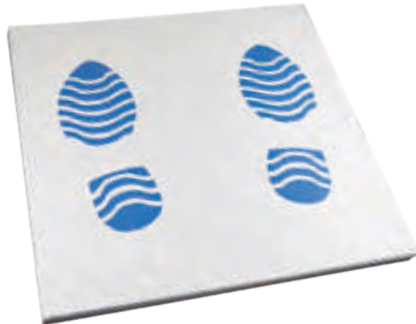

PROTECTOR DE VOLANTE PLÁSTICO

51824 36,80€

1,45 - 8 72
Kg SUB IT

250 UDS



KIT DE MANTENIMIENTO EN BOLSAS INDIVIDUALES

50916 0,88€

DISPENSADOR

0,05 100 400 3200
Kg SUB IT

5in1

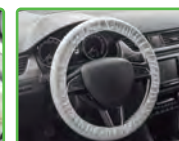

ALFOMBRIILLA DE PAPEL



FUNDA DE ASIENTO PARA COCHE

53226 14,90€

0,20 5 50 600

Kg SUB

- Universal.
- De nylon.

51cm 26,5cm 14mm

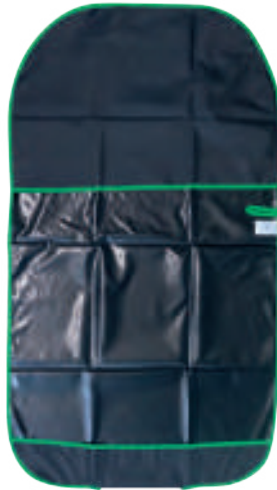

CORTINA PROTECTORA IMANTADA

51622 25,30€

0,45 - 30 540

Kg SUB

110cm 64cm



4 PUNTOS IMANTADOS

DOS CARAS:
UNA ATERCIOPELADA
Y UNA PLÁSTICA



VENTOSA NEUMÁTICA CON MARTILLO DESLIZANTE PARA ABOLLADURAS

52540 221,00€

4,36 - 3 72

Kg SUB

- Ventosa neumática con martillo deslizante para quitar abolladuras.
- Su diseño permite eliminar abolladuras de una manera rápida y fácil.



620mm

160 L/min 70-110 PSI

Ø 75, 100, 125MM

COLCHONETAS

DESPLIEGABLE

53192 52,00€

0,70 - 2 48

Kg SUB

- De espuma EVA.
- Medidas de la colchoneta plegada: 20cm x 42cm x 18cm

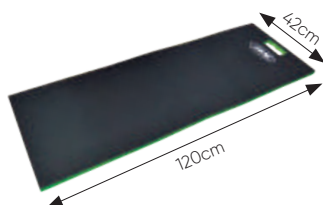

INDIVIDUAL

53191 14,80€

0,15 - 5 140

Kg SUB



- De espuma EVA.

32cm 48cm 18mm



IVA no incluido

PLATAFORMA DE ALUMINIO TELESCÓPICA

52230 398,00€

150 Kg

CUMPLE CON: EN 131

16,75	-	1	14
Kg	sub	ff	

- Ancho de la plataforma 300mm.
- Largo de la plataforma cerrada: 1.090mm.
- Largo de la plataforma extendida: 1.750mm.
- Altura ajustable de la plataforma: 520-900mm.
- Ancho del peldaño: 40mm.
- Distancia entre peldaños: 250mm.

- Posiciones: 42 (14 de horizontales x 3 de verticales)
 Altura 1: 520mm.
 Altura 2: 700mm.
 Altura 3: 900mm.

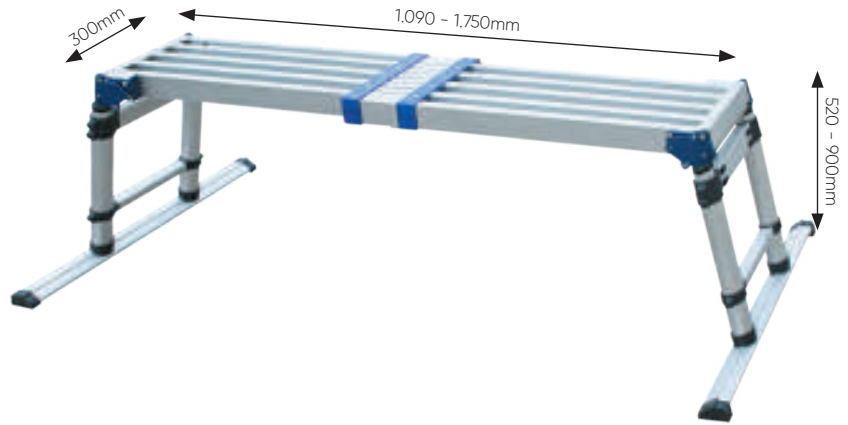

SUPER LIGERA



PLEGABLE



MONTAJE FÁCIL



PIE RECAMBIO PARA PLATAFORMA REF. 52230

10966 0,06 1
13,50€ Kg ff

TOPE DE ESCALÓN PARA PLATAFORMA REF. 52230

10965 0,01 1
6,00€ Kg ff

PROTECTOR ESQUINA PARA PLATAFORMA REF. 52230

10964 0,01 1
9,00€ Kg ff

PLATAFORMA DE ALUMINIO GRANDE

50913 195,00€

100 Kg

CUMPLE CON: EN 131

6,50	-	1	20
Kg	sub	ff	

800mm	1.400mm	300mm
-------	---------	-------



JUEGO DE 2 PLATAFORMAS DE ALUMINIO

50656 290,00€

CUMPLE CON: EN 131

10,45	-	1	8
Kg	sub	ff	

PLATAFORMAS DE ALUMINIO

15552 181,00€ 550mm 1.300mm 300mm

11897 155,00€ 300mm 1.000mm 300mm

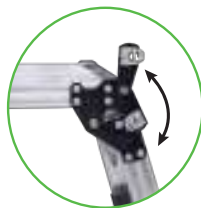

172



FRENOS

- 174 REPOSICIONADORES PARA PISTONES DE FRENO
- 176 REPARACIÓN / MANTENIMIENTO / SANGRADORES DE FRENO

PISTOLA REPOSICIONADORA DE FRENOS PERFIL BAJO

53683 116,00€

1.45	5	10	100
Kg	sub	ff	sub

- Presión de trabajo: 5-8 BAR.
- Presión máxima: 14 BAR.
- Entrada de aire 1/4".
- Soporte de disco magnético.
- Compatible con discos de 2 y 3 pins.



PISTOLA PARA POSICIONAR FRENOS - NEUMÁTICA

51283 78,00€

1.33	-	10	200
Kg	sub	ff	sub

- Presión de trabajo: 5-8 BAR.
- Presión máxima: 14 BAR.
- Entrada de aire 1/4".
- Soporte de disco magnético.
- Compatible con discos de 2 y 3 pins.



KIT REPOSICIONADOR PARA PISTONES DE FRENO CON PISTOLA

52636 114,00€

3.16	-	5	90
Kg	sub	ff	sub

16
PCS

- 0: GM most 2-1/2" diámetro pistones (Seville/Eldored 79)
 2: Citroën XM/Xantia (F/R), HONDA
 3: Audi (F), Fiat, Alfa romeo (F), Ford Fiesta (F), Isuzu (F), Honda Concesto (F), Jaguar XJ6/XJ40 (F/R), BMW 318is / 320i / 325T / 518i / 525i-1x / 740i / 850ci / M5 (F), Mercedes BENZ 190/200/300/420/560 serie (F), Mitsubishi Colt (F), Nissan Miera/Stanza/Sunny (F), Rover Austin/Metro 200-400 series/Maestra/Montego (F), Toyota Camry (F), VOLVO (F), VW Passat/Golf GTI (F)
 4: Ford Australia/NZ Telstar, Mazda (R), Saab 9000 (R)/Lumina, Toyota, Fiat 164 2.0 (R), Alfa Romeo Prelude/CRS 16i, Honda Saturn (R)/Grand Prix, GM
 5: 3/8" Usar el adaptador con una barra de extensión y una carraca para aplicar más fuerza a los pistones
 6: Nissan Primera, VW Golf IV
 7: Audi 80/90/V8+100/Coupe E (R), Rover 800 ABS, Subaru L+Z (R), Ford Sierra ABS/Granada/Scorpio ABS (R), Nissan Bluebird 1.8 Turbo/Silvia Turbo/Primera 2.0i LS-GS-GSX (R), Peugeot 405 1.9Gi/Gri/Sri/Gtxi/MI 16/605 2.0 Sri (R), Toyota

- Cecilia/Corolla GT/MR2 (R), VW Golf Gti/Jeta Synchro/Jetta Gti 16v, Passat CL, GL, GT, GT 16v, Corrado 16v scirocco GTX 16v(R), Citroën, Alfa romeo, Fiat, Honda, Jaguar, Renault, Saab, Seat, Lancia.
 8: GM most 1-7/8" diámetro pistones
 9: GM most 2-1/8" diámetro pistones
 A (Z): Renault (R21-Laguna (R))
 E: Nissan Maximas/Cefiro
 F (G): Opel (Rear disk) / Fiat Stilo
 K: Citroën C5
 M: Ford, Mini Cooper, Nissan Primera 03
 N: Saab, Honda, Alfa Romeo 164 2.0 Twin Spark/2.0 Turbo (88-)/3.0 V6, Audi 200 (80-)/Coupe GT SE (82-)/80/90/1QO/200/Quattro (87-)/90/20V (88-), Ford Mondeo 2.0/Ghia, Lancia Themaalte (85-), Volkswagen Golf II GTI (83-87)/Sirocco 16V (84)

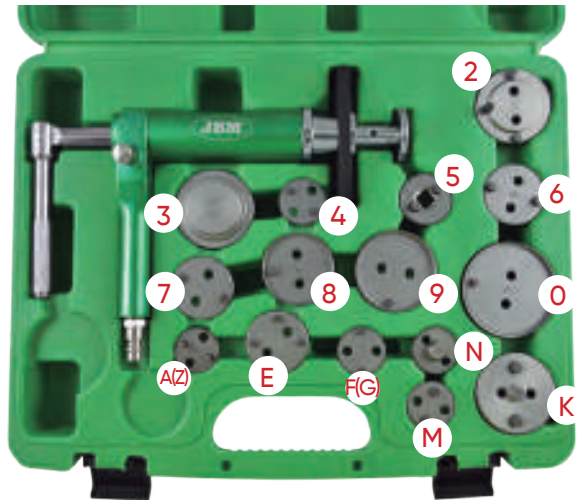

REPOSICIONADOR PARA PISTONES DE FRENO

52330 99,00€

5.68	-	3	54
Kg	sub	ff	sub

OPEL CITROËN PEUGEOT RENAULT 50 PCS

- 1pc: Pinza de rotación derecha (con rosca a la derecha)
 1pc: Pinza de rotación izquierda (con rosca a la izquierda)
 0 disco: Citroën 1: Disco 11: Disco para Jaguar tipo S
 12: Disco para BMW mini 5: 13/32" Adaptador (5) con 3/8" Dr. Interior-pt
 2: Citroën XM, Xantia u.a. 3: Alfa Romeo, Audi, Austin, BMW, Ford, Honda, Jaguar, Mercedes-Benz, Mitsubishi, Nissan, Rover, Toyota, VW
 4: Alfa Romeo 164 2.0, Ford, Mazda, Saab 9000, Subaru
 6: Nissan Primera, VW-Golf IV
 7: Audi 80,90,V8 +100, Ford Sierra ABS+ Scorpio ab 85, Honda Prelude, Nissan Silvia 1.8 turbo, Rover 8000, Saab 9000, Subaru L+Z, VW-Golf+ Passat
 8: GM Motors G: Opel 9: GM Motors K: Citroën C5
 O: GM Motors K1, K2: Citroën, Renault. M: Ford
 A: Nissan Primera 2.0, Bluebird N: Saab, Honda B: Ford, Lincoln, Subaru
 Z: Renault C: Mini Austin E: Cefiro, Maxima D: Citroën, Renault
 F: Peugeot 206 CC/Hdi/Gti. Requiere una llave de 16mm con pistones traseros.
 P: Audi, BMW, Ford, Lancia, Piston, Renault, Rover.
 J: Alfa Romeo 155 1.8-2.0 164 TD(93) 164 3.0 V6(91), Audi 80,90,A3,A4,A6,A8, Citroën ZX 2 Qi 16V, Fiat Tipo TD 16V, Uno Turbo (85) Crama TD, Ford Sierra (ABS bak). Granada (85) Crama TD, Ford Sierra (ABS bak). (Australia & NZ) Thunderbird Turbo, Honda CRX, 1.6i-16V (8-90), Accord 1800 (84-85) 2.0i. Prelude 16V (88), Legend V6, Jaguar XJ 4, Oseries, Lancia Dadra 2.0, Ei Tur (93), Delta 1.6 Gti, Nissan, Peugeot, Renault, Seat, Subaru, Volvo V40 6S40.
 R: Ford(Australia & NZ) Teslar, Laser, Mazda 323 Gti, GTXX (86-), 929 (82-), RX7(81-), 626 16V(87-), 626 GT (86-), 929 V6 (88-), Mitsubishi Galant GL Si, Toyota Celica, Corolla GT, MR2
 S: Audi 100 TQ(91), BMW 740i 8cyl (91), Lancia Delta 1.9 TD (95), Proton 416. Renault-most models, Renault Laguna 2.0 (94), Laguna 2.2 D (95) Safrane 2.0-2.2 TD V6, Rover 623 Si, Volkswagen Golf Gtu Mk 1&IV, Passat VR6, Vento GT (92)
 H6: BMW
 H7: BMW
 Pin 3.0
 Pin 5.5
 100g Grasa
 1/2"Dr+10mm Pentagon bit-56mm Sistema de frenos
 1/2"Dr+14mm tipo macho-38mm- para frenos pentágono en los frenos traseros del Opel Astra G, Zafira, Smart
 1/2"Dr+19mm tipo macho-8mm- para frenos Bendix, Citroën, Peugeot, Renault
 P1: Peugeot 307,308.

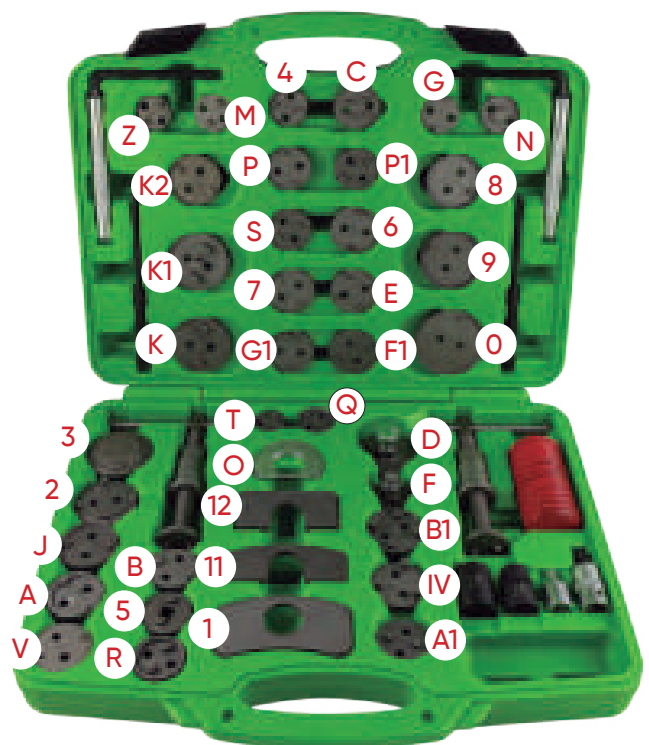

REPOSICIONADOR PARA PISTONES DE FRENO

51059

99,00€

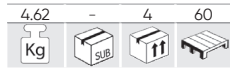

- Sistema de uso múltiple con 37 piezas para reposicionar los pistones de freno.
- Válido para la gran mayoría de vehículos.
- Contiene:
 - 2x llaves hex. de 6 y 7mm.
 - 2x tabillas para sistemas de freno de Mercedes y Opel.
 - 3x cojines de apoyo para usar en espacios limitados.
 - 3x cojines de apoyo para usar en espacios limitados.
 - 1x Fuelle con aceite lubricante.

1pc: Pinza de rotación derecha (con rosca a la derecha) 1pc: Pinza de rotación izquierda (con rosca a la izquierda)
 O: Disco 1: Disco 11: Disco para Jaguar tipo S 12: Disco para BMW mini 5: Adaptador 3/8 2: Citroen XM, Xantia (F/R)
 3: Alfa Romeo, Audi, Austin, BMW, Ford, Honda, Jaguar, Mercedes-Benz, Mitsubishi, Nissan, Rover, Toyota, VW.
 4: Alfa Romeo 164 2.0, Ford, Mazda, Saab 9000, Subaru. 6: Nissan Primera, VW-Golf IV.
 7: Audi 80, 90, V8 +100, Ford Sierra ABS+Scorpio ab 85, Honda Prelude Nissan Silvia 1.8 turbo, Rover 8000, Saab 9000, Subaru L+Z, VW-Golf +Passat.
 8: GM Motors. 9: GM Motors. O: GM Motors. M: Ford. N: Saab, Honda. Z: Renault. E: Cefiro
 ,Maxima. G: Opel. K: Citroen C5. K1, K2: Citroen, Renault.
 A: 1-3/16" disco de dos clavijas para Renault R21, Laguna. B: Ford, Lincoln, Subaru.
 C: Mini Austin. D: Citroen, Renault. F: Opel (disco trasero)
 P: Audi, BMW, Ford, Lancia, Proton, Renault, Rover, VW.
 J: Alfa Romeo 155 1.8-2.0 164 TD(93) 164 3.0 V6(91) Audi, 80, 90, A3, A4, A6, A8 Citroen ZX 2 Ql 16V, Fiat Tipo TD 16V, Uno Turbo(85) Crama TD, Ford Sierra(ABS bak), Granada (85), (Australia & NZ) Thunderbird Turbo, Honda CRX, 1.6-16V (8-90), Accord 1800(84-85) 2.0i, Prelude 16V(88), Legend V6, Jaguar XJ40 series, Lancia Dedra 2.0 Ei Tur(93), Delta 1.6 Gti, Nissan, Peugeot, Renault, Seat, Subaru, Volvo V40 & S40.
 R: Ford (Australia & NZ) Telstar, Laser, Mazda 323 Gti, GTX(86-), 929(82-), RX7(81-), 626 16V(87-), 626 GT (86-), 929 V6(88-), Mitsubishi Galant GL Si, Toyota Celica, Corolla GT, MR2.
 S: Audi 100TQi(91), BMW 740i 8cyl.(91), Lancia Delta 19 TD(95), Proton 416, Renault-most models, Renault Laguna 2.0 (94), Laguna 2.2 D(95), Safrane 2.0-2.2 TD V6, Rover 623 Si, Volkswagen Golf Gti Mk 3&4, Passat VR6, Vento GT(92).
 H6: BMW H7: BMW Pin Ø 3.0 Pin Ø5.5 100g Grasa.

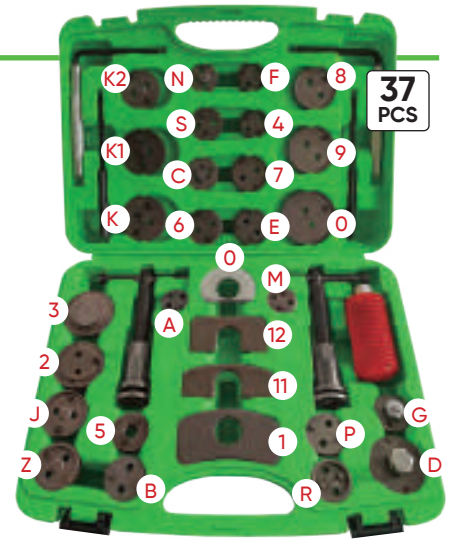

37 PCS

REPOSICIONADOR PARA PISTONES DE FRENO

53978

38,90€



- Set utilizado para la compresión de los pistones de las pinzas de freno.

O: Placa
 1: Placa
 2: General Motors (Ø pistones 21/2")
 3: Citroën XM, Xantia
 4: Alfa Romeo, Audi, Austin, BMW, Ford, Honda, Jaguar, Mercedes-Benz, Mitsubishi, Nissan, Rover, Toyota, VW
 5: Adaptador cuadrado 3/8"
 6: Nissan Primera, VW, Golf IV
 7: Audi 80, 90, V8+100, Ford Sierra ABS+Scorpio de 1985, Honda Prelude, Nissan Silvia 1.8 turbo, Rover 8000, Saab 9000, Subaru L+Z, VW Golf + Passat
 8: General Motors (Ø pistones 17/8")
 9: General Motors (Ø pistones 21/8")
 IV: VAG, Renault, Volvo con freno de estacionamiento electrónico
 R: Renault
 E: Nissan Maxima, Cefiro
 F: Opel
 J: Para Fiat Tipo TD 16V, Uno Turbo(85) Crama TD, Honda CRX, Alfa Romeo 155 1.8-2.0i, 164 TD (93), 164 3.0 V6 (91); Audi 80, 90, & V8's, A3, A4, A6, A8 (pinza trasera); Citroen ZX 2. Ql 16v; Fiat Tipo TD 16V, Uno Turbo (85-), Crama TD; Ford Sierra (ABS bak), Granada (85-); Ford (Australia & NZ) Thunderbird Turbo; Honda CRX, 1.6-16V (88-90), Accord 1800 (84-85), 2.0i (86-), Prelude 16V (88-), Legend V6; Jaguar XJ serie 40; Lancia Dedra. 2.0 Ei Tur(93), Delta 1.6 Gti. (92), The. majE 16v(92), Thema. 2000 Turbo. Kappa 2.Q-2.4LS, 2.4TD; Nissan 280 ZX (82-84), 300 ZX Turbo (84-89), Bluebird 16V (89-), Silvia 1.8 Turbo (85-88) 100 NZ 2.0 (93), Primera 2.0 GT (94), 200 SX turbo 16V, Maxima 2. 0 GX-3.0 GX (95); Peugeot 306; Peugeot 309 Gtj 16S (91), 405. Srif Q. rj, Gil (87-), 405 M.I 16v; Renault Master Van; Rover 216 Gti 16V, 820 Si 2. 0(93), 825 SD 2.5 (93); Saab 9000 CS 2.0(93), 9000 CSE Turbo(93); Seat Toledo GT. 16V-GT 2.0(93), Lbiza 1.8 Gti 16V(95); Subaru Lserie & Serie 2; Volkswagen Passat 2.0 & 2.2 Litre(84), Golf Rallye (-89), Golf II Gti 16V(89-), Vento GT (92), Transporter T4; Volvo S40 & V40
 K: Citroën
 K1: Citroën
 K2: Citroën
 5: M: Ford
 4: N: Saab, Honda



23 PCS

SET REPOSICIONADOR DE FRENOS UNIVERSAL

52906

38,00€

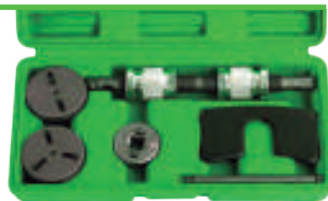

12974

12975

REF.	DESCRIPCIÓN	Kg	mm	€
12974	Recambio 2 pins	0,15	50	21,00€
12975	Recambio 3 pins	0,17	50	23,00€

- Alfa Romeo 164 2.0, Ford, Mazda, Saab 9000, Subaru, Nissan Primera, VW, Audi, Ford Sierra ABS + Scorpio ab 85, Honda Prelude, Nissan Silvia 1.8 turbo, Rover 8000, Saab 9000, Ford, Opel, BMW, Lancia, Proton, Renault, Rover, Peugeot 307, 308 A3- Iveco Daily, Volkswagen Passat 2.0 TDI 09, Renault Laguna.

MÓDULO REPOSICIONADOR DE FRENOS

14142

109,00€

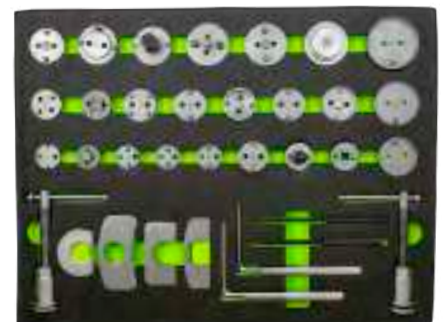
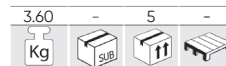

34 PCS

- 24x adaptadores
- 4x placas de retención
- 2x ejes para roscar
- 2x punzones
- 2x llaves hexagonales

SANGRADOR DE LÍQUIDO DE FRENOS

52191 198,00€

9,05 - 1 15
Kg SUB

- Presión de trabajo: de 0 a 4 kg/cm².
- Aire de 1/2".
- Peso: 5Kg.
- Adaptadores: 11 + 2 universales.
- Aplic.: GM, Chrysler, Nissan.



330mm 230mm 230mm



TAPONES PARA SANGRADOR DE FRENOS PARA VEHÍCULOS GM, CHRYSLER, GM, NISSAN

52328 99,00€

2,90 - 4 68
Kg SUB

- 9 Adaptadores de aceite de los frenos: Universal n°1, n°2, n°3, n°4



ESTUCHE PARA REPARACIÓN / MANTENIMIENTO DE FRENOS

52434 125,00€

3,25 - 5 100
Kg SUB

- Contiene: Llaves de tuerca de freno. Alicates de muelle de freno. Destornillador de impacto. Vasos destornilladores. Herramienta de ensamblaje. Destornillador con articulación universal. Herramienta especial freno. Cepillo de limpieza. Cepillo de limpieza de latón. Herramienta de ensamblaje. Alicates de cable de freno. Lima para mordaza de freno.



ALICATES PARA FRENO DE TAMBOR

52625 9,00€

0,35 - 6 48 1824
Kg SUB

- Para extraer e instalar resortes de retorno en frenos de tambor.



SET DE VASOS PARA PINZAS DE FRENO

54135 82,00€

1,45 - 5 10 400
Kg SUB

- Audi (A4, A5, S5, S8, Q5, Q7)
- Porsche (Cayenne, Macan, Cayman)
- Mercedes Benz
- Ford
- BMW
- Alfa Romeo

Diseñado para el desmontaje de las pinzas de freno cuando se realiza la sustitución de las pastillas de freno.



1/2"				
	Øx2	14x38mm	22x38mm	
	Øx3	11,50x38mm	11x38mm	20x38mm
	Øx4	10mm	12,50mm	19mm
	Øx1	10mm		
3/8"				
	Øx4	H11X100mm	H7x70mm	H7x29mm H9x50mm
	Øx2	7x24mm	8x24mm	
1/4"				
	Øx1	9x20mm		

SEPARADOR DE PISTÓN Y FRENO

52315 16,00€

0,88 - 5 20 640
Kg SUB

- Apertura máxima: 80mm.



COMPROBADOR DE LÍQUIDO DE FRENOS

51839 24,00€

0,05 - 25 100 2400
Kg SUB

- Funciona a pilas 1xAAA LR03.
- Con 4 niveles de calidad medibles del 0% al 4%.



JUEGO DE GALGAS PARA PASTILLAS DE FRENO

52455 16,00€

0,26 - 10 20 864
Kg SUB

COLOR	METRIC	SAE
	8-10-12mm	0.3150-0.4720"
	4-5-6mm	0.1575-0.2382"
	2-3mm	0.0787-0.1181"



SANGRADOR DE FRENOS NEUMÁTICO

52275 38,00€

0,79 - 4 112
Kg SUB



- Temperatura de trabajo: 10°C a 50°C.
- Manguera silicona: 1m.
- Pistola de soplado con entrada 1/4".
- Presión aire: 6-12 bar (87 - 174 psi).
- Consumo de aire: 180l/min.





UTILLAJE

- 178 SISTEMA DE LUBRICACIÓN
- 183 SISTEMA DE INYECCIÓN
- 187 REPARADOR DE ROSCAS
- 189 MEDIDOR DE COMPRESIÓN
- 190 CALENTADORES
- 191 EXTRACTORES
- 203 DINAMOMÉTRICAS
- 205 MULTIPLICADORES DE FUERZA /
EMBAGUE
- 207 SISTEMA AACC
- 208 SISTEMA DE REFRIGERACIÓN
- 210 CULATA / VÁLVULAS
- 211 COMPRESORES DE MUELLES
- 212 VARIOS
- 214 ORGANIZADORES / BANDEJAS
- 215 CORTADORAS DE CADENA / CEPILLOS

JUEGO DE VASOS PARA FILTROS DE ACEITE/ 19 PIEZAS EN ALUMINIO

54068 198,00€

4,00	-	2	48
Kg	sub	ff	

19
PCS

DESPIECE DISPONIBLE

REF.	Nº DE PIEZA	DESCRIPCIÓN	Ø x CANTOS				€
15494	05101	Mazda, Mitsubishi	100,5mm x 15	5	10	12,50€	
15495	0595	Nissan, Toyota	94,5mm x 15	5	10	12,50€	
15496	0592	Nissan, Subaru	92mm x 15	5	10	11,50€	
15497	0579	Toyota, Honda, Mitsubishi, Subaru, Mazda, Lsuzu	79mm x 15	5	10	11,00€	
15498	915	Volvo	87mm x 16	5	10	11,50€	
15499	901L	Lexus	79,5mm x 14	5	10	11,00€	
15500	901T	Toyota	70mm x 14	5	10	10,00€	
15501	901-1	Toyota	63-64mm x 14	5	10	10,00€	
15502	902	Ford, Mazda	66,5mm x 14	5	10	10,00€	
15503	1284	Dodge Sprinter (2007-), Mercedes Benz E320 (2007-), Jeep Cherokee 3.0L V6 Common Rail (2007-)	84mm x 14	5	10	11,00€	
15504	903B	Mercedes Benz	74mm x 14	5	10	10,00€	
15505	24mm	BMW 5, BMW 7, BMW X5 V8 (N62) (2004-), Saturn (2008), Astra 1.8L ECOTEC, Chrysler 3.6L V6 (2011-), 200, 300, T/C Dodge Jeep	24mm x 14	5	10	4,00€	
15506	27mm	Mercedes Benz Clase A	27mm x 6	5	10	4,00€	
15507	30mm	Audi A2, Vw Polo, Lupo 1.4L/1.6L	30mm x 6	5	10	4,50€	
15508	32,5 mm	Opel Astra G, Corsa B, Zafira, Audi, VW 1-36 mm, Opel Omega, Vectra B, Zafira (98-), BMW M43/60	32,5mm x 6	5	10	4,50€	
15509	36mm	Opel Omega, Vectra B, Zafira (98-), BMW M43/60, Mercedes Benz Vito CDI, C, E, VW Lupo 1.2 TDI, MAN	36mm x 6	5	10	5,00€	
15510	38mm	Opel Vectra 2.0D	38mm x 6	5	10	5,00€	
15511	917	Universal	55-90mm	5	10	8,00€	



JUEGO DE VASOS PARA FILTROS DE ACEITE

51332 98,00€

4,20	-	5	60
Kg	sub	ff	

23
PCS

DESPIECE DISPONIBLE

REF.	Nº DE PIEZA	DESCRIPCIÓN	Ø x CANTOS				€
11374	901	Toyota, Nissan, Fiat Daihatsu	65mm x 14	0,10	5	20	5,50€
11375	902	Toyota, Daihatsu	67mm x 14	0,08	5	20	6,50€
11376	903	VW, Mercedes, BMW, Opel, Audi	74mm x 14	0,09	5	20	5,50€
11377	903-1	GM/AC, Wix, Ford, Isuzu	75mm x 15	0,09	5	20	5,50€
11378	903-2	VW, Audi, Seat, BMW, Renault	74mm x 8	0,09	5	20	6,50€
11379	903-3	Audi, Rover, Chrysler	74mm x 15	0,11	5	20	6,00€
11380	903-4	Toyota, Lexus	73mm x 14	0,11	5	20	6,50€
11381	903-6	Schlepper, Baumashinen	75mm x 12	0,10	-	50	6,50€
11382	918	Rover, Chrysler, Audi	74mm x 15	0,11	5	20	6,00€
11383	904	Nissan, Ford	79mm x 15	0,10	5	20	6,00€
11384	905	GM, Chrysler	73mm x 15	0,12	5	20	6,00€
11385	905-1	BMW, Mercedes, Opel, Audi, VW	74mm x 14	0,10	5	20	5,50€
11386	906	Baumaschinen, Schlepper	84mm x 18	0,10	5	20	6,00€
11387	907	Mitsubishi, Toyota	89mm x 15	0,13	5	20	6,00€
11388	908	Nissan, Toyota	91mm x 15	0,14	5	20	6,00€
11389	915	Honda Accord, Mitsubishi, Isuzu	90mm x 15	0,16	5	20	6,00€
11390	910	Toyota, Alfa Romeo, Ford	95mm x 15	0,12	5	20	6,00€
11391	911	Fiat, Renault, Citroën	80mm x 12	0,09	5	20	6,50€
11392	911-1	Subaru, Toyota, Honda, Nissan	80mm x 15	0,09	5	20	6,00€
11393	914	Mazda, Toyota	101mm x 15	0,18	5	20	6,00€
11394	909	Isuzu, Nissan	92mm x 15	0,14	5	20	6,00€



REF.	DESCRIPCIÓN				€
14992	Llave de 12 cantos	0,10	-	-	8,50€
10955	Carraca de 1/2"	0,14	-	1 50	11,00€

VASOS PARA FILTRO DE ACEITE

52311 19,00€ 0,13 6 72 1728 Kg SUB I1 I2 GRUPO VAG 42mm	52312 9,00€ 0,10 10 100 1800 Kg SUB I1 I2 VW, OPEL, MERCEDES, BMW, AUDI 74mm x 14C	52313 8,00€ 0,20 6 68 1008 Kg SUB I1 I2 VOLVO 540, 560, 570, 580 86mm x 16C
52314 26,60€ 0,20 5 50 600 Kg SUB I1 I2 BMW VOLVO 87mm x 16C	52809 8,50€ 0,15 10 100 1000 Kg SUB I1 I2	53441 9,80€ 0,20 5 20 800 Kg SUB I1 I2 TOYOTA 64,5mm x 14C 76mm x 14C

Presentación en caja

EXTRACTOR DE FILTROS DE ACEITE FORD, CITROËN, PEUGEOT 2.0, 2.2 HDI, TDCI

53008 15,50€

0,60 5 30 1500
Kg SUB I1 I2

250mm

EXTRACTOR FILTROS CAMIÓN

52518 115,00€

1,40 6 12 480
Kg SUB I1 I2

95-165mm

SET DE VASOS PARA FILTROS DE ACEITE

52615 112,00€

3,05 - 5 70
Kg SUB I1 I2

- Llave de doble sentido ajustable.
- Rango de aplicación: 60-80mm.

Audi, BMW, Mercedes, Opel, Renault, Volvo, Kia, Hyundai, Ford, VW, Skoda, Citroën, Mini

9 PCS

1/2" x1 UNIVERSAL 63-83mm

3/8" x8

- 27mm: Mercedes-Benz, Smart.
- 32mm: GM, Opel/Vauxhall, Mercedes-Benz.
- 36mm: Mercedes Diesel, BMW, Mini, Ford.
- 15 - 88,8mm: Hunday, Kia.
- 14 - 64,5mm: Toyota (Allion, Auris, Corolla, Prius, Voxy, etc.).
- 64,5mm: Toyota, Lexus (6 Zyl.).
- 74,2mm: Audi, BMW, Ford, Toyota, Volkswagen, Porsche, Mercedes-Benz.
- 16 - 86,6mm: BMW 3+5+X, Volvo.

EXTRACTOR FILTRO DE ACEITE CON PATA REDONDA / PLANA

- Puede usarse con llaves de 1/2" o 3/8".

51352 9,80€ 0,40 5 40 960 Kg SUB I1 I2 57-118mm	51934 11,50€ 0,40 10 40 1200 Kg SUB I1 I2 57-118mm	51353 11,50€ 0,65 5 40 960 Kg SUB I1 I2 72-136mm	51923 12,50€ 0,56 10 40 960 Kg SUB I1 I2 72-136mm
---	--	--	---

- Extrae todos los filtros de aceite de 2-1/4" a 5" de diámetro.

- Extrae todos los filtros de aceite de 2-1/2" a 4" de diámetro.

- Extrae todos los filtros de aceite de 2-1/2" a 4" de diámetro.

- Extrae todos los filtros de aceite de 2-1/2" a 4" de diámetro.

SET 5 VARILLAS PARA COMPROBACION ACEITE BENZ/AUDI

53206 38,20€

5
PCS

0,55	5	20	140
Kg	Sub	ff	ff

- Para comprobar el fluido de transmisión de aceite en los motores Audi 100:
La punta (primera 11 mm) es la lectura del fluido frío a 20 °C.
La segunda lectura es el mínimo a 80 °C.
La tercera lectura es a 80 °C máximo.
- Mantenga el nivel del vehículo al revisar ATF.
- Varilla medidora del motor para comprobar el nivel de aceite, compatible con una gran selección de motores de 1988 a 2005 en la gama Mercedes.

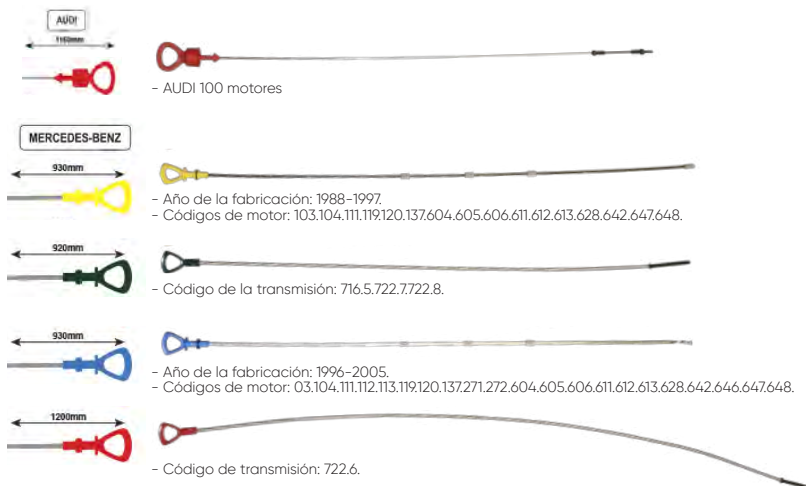

- AUDI 100 motores

MERCEDES-BENZ

- Año de la fabricación: 1988-1997.
- Códigos de motor: 103.104.111.119.120.137.604.605.606.611.612.613.628.642.647.648.

- Código de la transmisión: 716.5.722.7722.8.

- Año de la fabricación: 1996-2005.
- Códigos de motor: 03.104.111.112.113.119.120.137.271.272.604.605.606.611.612.613.628.642.646.647.648.

- Código de transmisión: 722.6.

VARILLA PARA COMPROBACIÓN DE ACEITE - AUDI

13856 7,80€

0,04	5	100
Kg	Sub	ff

PINZA EXTRACTORA DE FILTROS DE ACEITE

51354 13,20€

0,43	5	40	600
Kg	Sub	ff	ff

80-120mm



LLAVE PARA FILTRO ACEITE GRUPO VAG DSG 1/2" 24MM

53670 29,50€

0,25	10	40	1680
Kg	Sub	ff	ff

1/2"

- Herramienta especial diseñada para el montaje y desmontaje del filtro de aceite del engranaje DSG.
- Su tamaño reducido permite alcanzar fácilmente el filtro de aceite del engranaje DSG sin necesidad de quitar la batería.



EXTRACTOR DE FILTROS DE CINTA

52269 7,00€

0,20	10	50	1200
Kg	Sub	ff	ff

80-120mm



CINTA DE RECAMBIO 360mm

11106 3,00€

0,02	10	50
Kg	Sub	ff

EXTRACTOR DE FILTROS AJUSTABLE

52677 17,00€

0,32	10	40	480
Kg	Sub	ff	ff

∅ 65-105mm

52678 18,00€

0,33	10	40	400
Kg	Sub	ff	ff

∅ 110-155mm



EXTRACTOR FILTROS DE CADENA

52417 28,00€

0,90	5	25	800
Kg	Sub	ff	ff

∅ 160mm 300mm

CADENA DE ALTA RESISTENCIA
SUPERFICIE DENTADA PARA UN ÓPTIMO AGARRE



EXTRACTOR FILTROS DE CORREA

52416 14,00€

0,37	5	50	900
Kg	Sub	ff	ff

∅ 150mm 20mm 540mm

CORREA DE POLÍMERO (ALTA RESISTENCIA)
SUPERFICIE DENTADA PARA UN ÓPTIMO AGARRE



EXTRACTOR DE FILTROS DE ACEITE DE CADENA

52607 49,00€

0.85	6	24	576
Kg	Sub	Up	Tray

Ø 60 - 140mm

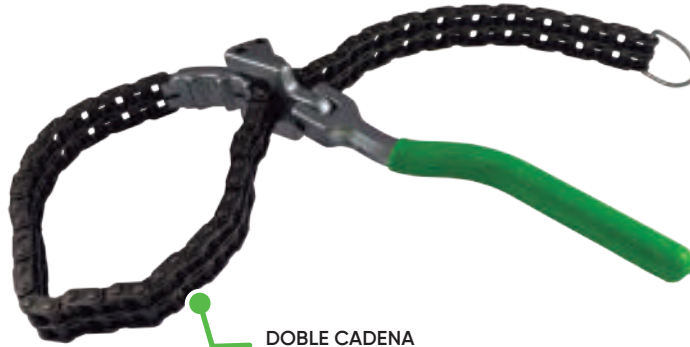

52608 44,00€

0.95	6	24	360
Kg	Sub	Up	Tray

Ø 60 - 195mm

DOBLE CADENA ARTICULADA



TAPONES DE CÁRTER PLÁSTICOS

53741 14,00€

0.05	10	100	4000
Kg	Sub	Up	Tray

FORD/PSA



13969 19,00€

0.01	10	100	-
Kg	Sub	Up	Tray

VAG



53537 14,50€

0.05	10	100	4000
Kg	Sub	Up	Tray

BMW



53538 14,50€

0.10	10	100	4000
Kg	Sub	Up	Tray

FORD



5 PCS

JUEGO DE VASOS PARA TAPONES CÁRTER

53735 44,00€

1.70	-	5	375
Kg	Sub	Up	Tray

3/8" 23 PCS

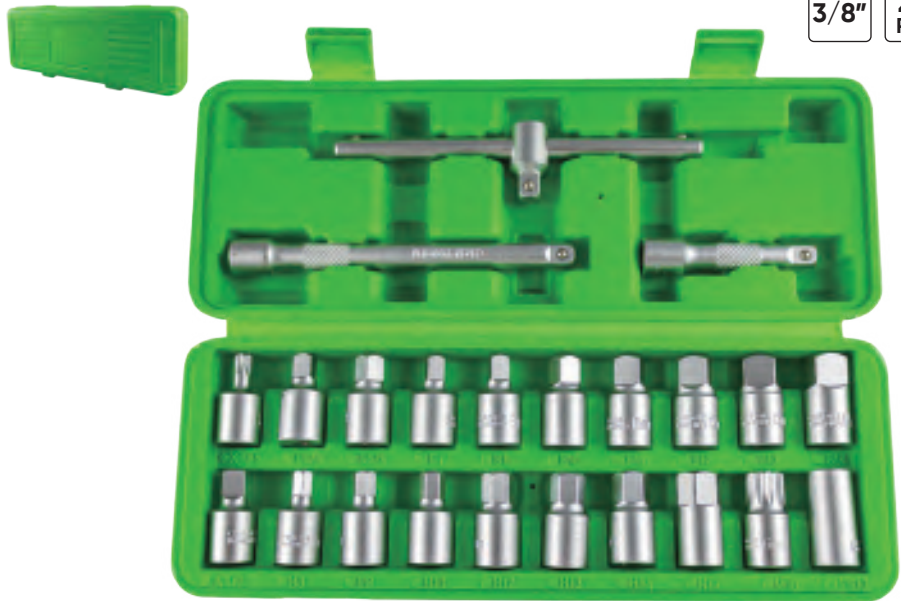

CONTIENE

	x2	5/16", 3/8"
	x7	7, 8, 10, 11, 12, 13, 14mm
	x1	10mm
	x1	10mm
	x7	8, 9, 10, 12, 13, 14, 17mm
	x1	T45
	x1	M16
	x1	200mm
	x2	75, 150mm

MÓDULO EVA JUEGO DE VASOS PARA TAPONES DE CÁRTER

15084 68,00€

1.70	-	-	-
Kg	Sub	Up	Tray

MÓDULO ACABADO EN FIBRA DE CARBONO

240x135x32mm

22 PCS

CONTIENE

	x2	5/16", 3/8"
	x7	7, 8, 10, 11, 12, 13, 14mm
	x1	10mm
	x1	10mm
	x7	8, 9, 10, 12, 13, 14, 17mm
	x1	T45
	x1	M16
	x1	200mm
	x1	150mm

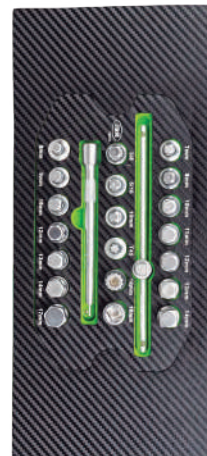

LLAVE PARA TAPÓN DE CÁRTER DE PLÁSTICO (VAG)

53472 12,00€

0.10	10	100	1200
Kg	sub	ff	ff

OEM: T10549



- Función: Para la extracción de tapones de cárter de plástico.

- Aplicaciones:

Audi: A1, A3, A4, A5, A6, A7, Q3, Q5, Q7, TT, TTS.

Seat: Alhambra, Leon, Toledo.

Skoda: Octavia, Rapid, Superb, Yeti.

VW: Beetle, Caddy, CC, Golf, Jetta, Passat, Polo, Scirocco, Sharan, Tiguan, Touran.

LLAVE PARA TAPÓN DE CARTER

52617 7,00€

0.23	6	36	1512
Kg	sub	ff	ff

8 - 10mm

- Para Citroën, Renault, Peugeot.



SET EXTRACTOR DE TAPONES DE CÁRTER DE PLÁSTICO

53473 36,00€

0.40	10	50	800
Kg	sub	ff	ff

5
PCS

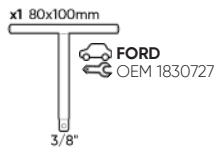

FORD, VAG, PEUGEOT, CITROËN, BMW

KIT DE REPARACIÓN DE TAPONES DE CÁRTER

51337 50,00€

1.55	-	10	180
Kg	sub	ff	ff



- Tapones de SKS3.
- Brocas de 1015.
- Arandelas de cobre.

- Contiene:
M13x1,5P
M15x1,5P
M17x1,5P
M20x1,5P

- Brocas: 1 x medida
- Tapones: 5 x medida
- Arandela: 10 x medida

DESPIECE DISPONIBLE

5 tuercas + 5 arandelas*

*Entregado en bolsas de 5 unidades.
Machos

REF.	DESCRIPCIÓN	Kg	sub	ff	ff	€
51403	M13 x 1.5P	0,13	5	50	100	17,50€
51400	M15 x 1.5P	0,17	5	50	100	17,00€
51401	M17 x 1.5P	0,15	5	50	100	22,00€
51402	M20 x 1.5P	0,10	5	25	50	20,50€

REF.	DESCRIPCIÓN	Kg	sub	ff	ff	€
14930	M13 x 1.5P	0,05	10	100	100	9,50€
14931	M15 x 1.5P	0,05	50	100	100	8,00€
14932	M17 x 1.5P	0,07	5	100	100	9,50€
14933	M20 x 1.5P	0,10	5	100	100	9,50€

SET REPARADOR DE ROSCAS DE TAPÓN DE CÁRTER

53235 10,40€

0.25	10	40	-
Kg	sub	ff	ff

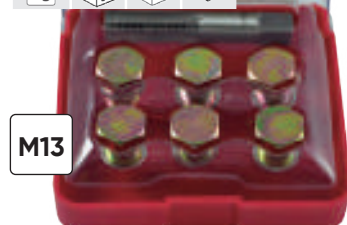

M13

53236 11,50€

0.35	10	40	-
Kg	sub	ff	ff



M15

53237 12,90€

0.35	10	40	-
Kg	sub	ff	ff

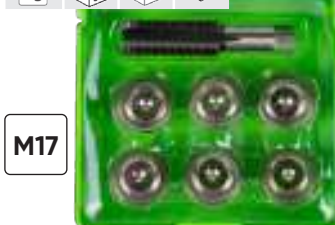

M17

53238 18,40€

0.40	10	40	-
Kg	sub	ff	ff



M20

EXTRACTOR NEUMÁTICO PARA INYECTORES

54186

320,00€

Bosch, Delphi, Denso, Siemens

S

6-8 bar

20-30 Nm

6,79 - 2 80
Kg SUB



EXTRACTOR DE INYECTORES HIDRAULICO

54245

580,00€

Bosch, Delphi, Denso, Siemens

1795 - 1 100
Kg SUB

Este conjunto de herramientas, está diseñado para sacar los inyectores más apretados sin apenas esfuerzo, gracias a su sistema hidráulico que permite ejercer una fuerza de hasta 10 toneladas

Conexión cilindro hidráulico: 3/8" NPT
Fuerza cilindro hidráulico: 10 toneladas

Puede ser usado de manera mecánica o con bomba hidráulica manual.



M17 x 1.0	Bosch	M20 x 1.0	Denso
M14 x 1.5	Delphi	M25 x 1.0 / M27 x 1.0	Siemens
M16 x 1.0	Toyota		

BOMBA HIDRAULICA MANUAL

54257

318,00€

11,40 - 1 32
Kg SUB

1,8m

1000 PSI

PARA REF. 54245

Número de etapas: 2
Presión de trabajo:
Etapa 1: 0-20 kg/cm3
Etapa 2: 20-700 kg/cm3
Máxima presión de trabajo: 1000 PSI
Aceite útil: 700cc
Caudal por embolada:
Etapa 1: 13cc
Etapa 2: 2,3cc
Longitud manguera: 1,8m
Conexión: 3/8" NPT
Peso: 10,32kg



EXTRACTOR DE INYECTORES DIESEL PARA CITROËN, PEUGEOT

53069

98,00€

CITROËN PEUGEOT

3,44 - 5 150
Kg SUB



- 1x Base.
- 3x pilares para la base.
- 2x Husillo extractor - Ø17mm, Ø25mm.
- 1x Tuerca para husillo.
- 2x Vasos para inyectores de 25mm y 29mm.
- 1x Llave Allen de seguridad de 21mm.

KIT DE EXTRACCIÓN DE INYECTORES UNIVERSAL

51494

107,00€

3,60 - 4 96
Kg SUB



- Con martillo deslizando para motores CDI y motores Mercedes CDI OM 611, 612, 613 etc. Para extraer los inyectores atascados y common-rail sin desmontar la culata.

- La construcción robusta permite una reducción drástica de los inyectores más severamente bloqueados.

- Material: acero S45C.

- Longitud total: 350mm

- Contenido:
Martillo: 1,75 kg,
Adaptador: M17x1,0
Adaptador para la boquilla Bosch: M27 x 1,0
Adaptador tirador w/M12 x 1,75P



LLAVE ABIERTA DOBLE PARA INYECTORES

52821

28,80€

0,24 - 6 96 -
Kg SUB



- Material: Chrome Vanadium.
- Doble estrella abierta acodada.
- Adecuada para zonas de difícil acceso.

17mm



SET DE EXTRACTORES DE INYECTORES

52858

298,00€

- Para la extracción de los inyectores diesel.
- Adecuado para la mayoría de los inyectores diesel debido a muchos adaptadores incluidos.

21,20	-	1	40

- Componentes:

3 martillos deslizantes diferentes:

- 1,6 kg, longitud 160 mm.
- 2,7 kg, longitud de 460 mm.
- 5,1 kg, longitud 600 mm.

2 garras de tiro con apertura de horquilla:

- 13,7 x 18 mm, longitud 105 mm.
- 12,7 x 19 mm, longitud 130 mm.

5 vasos ranurados 1/2" y 6 caras, longitud 100 mm, tamaños:

- 25, 27, 28, 29, 30mm.

Extractor de inyector, diseño del manguito, con casquillos:

- Diámetro exterior 35 mm.
- Diámetro interior 29 mm.
- Husillo m17 x 1,0.

Adaptador de tiro con rosca exterior:

- M27 x 1,0 (3 piezas) y M25 x 1,0.

Adaptador de tiro con rosca interior:

- M27 x 1,0 (3 piezas).

Adaptador para el martillo deslizante para extractor interior, exterior y garra.



ESTUCHE ARANDELAS DE COBRE PARA INYECTORES 551 ARANDELAS

53464

153,00€

1,85	-	5	90



551
PCS

pg.328

EXTRACTOR DE BOMBA DE INYECCIÓN DIESEL BMW

53501

24,00€

- Sostiene las ruedas dentadas durante el montaje de la bomba de inyección.

0,55	10	20	1120

- BMW: M47 / M47T2 / M47TU / M57 / M57TU.
- SERIES: E46 (318D-320D) (1988 - 2005) and E60, E61 (318TD-320TD-525D-530D-530-535) (2000 - 2006).
- OEM1 13 5 191 | 13 5 192 | 13 5 190 BMW.



EXTRACTOR PARA INYECTORES MERCEDES

52629

99,00€

MERCEDES

1,22	5	10	440



M16X1.5

EXTRACTORES DE TUBOS DE INYECCIÓN DIESEL

53009

42,00€

0,50	4	20	560



14, 17, 19mm



- Especifico para Mercedes (C/E/S CLASS, VITO) INJ.
- Mercedes / Bosch solución inyector.
- Extractor específico para inyectores Mercedes, completo, con enchufe para el desmontaje de la conexión eléctrica.

EXTRACTOR DE ARANDELAS DE INYECTORES

53522

24,00€

Ø 4,5 - 15mm

0,80	5	20	480



MEDIDOR Y COMPROBADOR DE SISTEMA DE INYECCIÓN

51493 68,00€

1.85	-	5	80
Kg	sub	ff	ff

Adecuado para uso en **BOSCH, SIEMENS, DENSO y DELPHI**

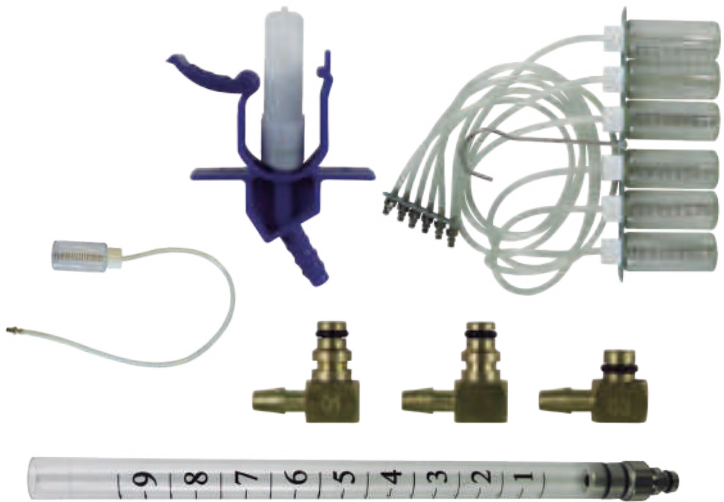

- El propósito de este instrumento es medir con rapidez y eficacia la cantidad de combustible (diesel o gasolina) que cada inyector vuelve al tanque de depósito, de modo que usted sabrá si algún inyector está dañado.

BOTE + TAPÓN + MANGUERA

12901	0.03	10	60
5,20€	Kg	sub	ff

- Incluye:
Percha para colgar con 6 botellas de medición graduadas.
6 tubos de medición (para crack única condición).
Tubos blancos de descuento.
Estuche de almacenaje

SET 17 PCS ESCARIADOR INYECTORES

52813 79,00€

2.23	-	5	180
Kg	sub	ff	ff

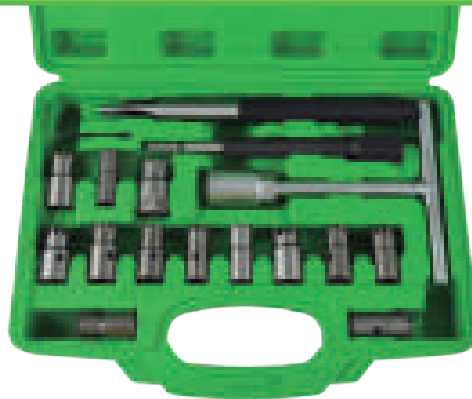

17
PCS

	x8	Max 16, 15x19, 15.5x15.5, 17x17, 17x17.5, 17x19, 17x19.5, 17x20mm	x1 19x225mm
	x5	15.5x15.5, 17x17, 17.5x20.5, 17x21mm	x1 19x170mm
	x1	19x21.5mm	x1 19mm
	x1	2.5mm	x1 12cm

- Para el reacondicionamiento de los inyectores.

SET ESCARIADOR INYECTORES

52273 44,00€

1.40	-	5	180
Kg	sub	ff	ff



8
PCS

	x3	15x19, 17x19, BMW / PSA / RENAULT / FORD, 17x19, MERCEDES CRD	x1 12cm
	x2	17x17mm, MERCEDES-BENZ CDI, 17x21mm, FIAT / IVECO	x1 19mm

- Juego de 7 escariadores para limpiar los asientos de los inyectores, cuando en los motores diesel se reacondicionan o sustituyen los inyectores.



KIT DE LIMPIEZA DE ASIENTOS DE INYECTORES

53650 47,00€

0,90	-	10	140
Kg	Sub	ff	ff

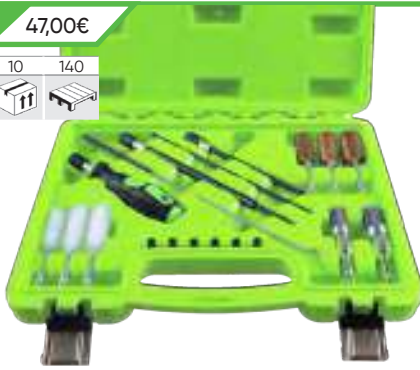

- Kit con tres cepillos de acero revestido de latón para limpiar los restos de carbonilla restantes de las paredes laterales del ASIENTO DE INYECTORES así como dos cepillos de nailon de silicona para limpiar la base DEL ASIENTO.
- Los cepillos de limpieza pueden conectarse rápidamente a la extensión flexible proporcionada.
- Este kit también contiene seis tapones de sellado y una varilla de inserción para evitar que los restos de carbonilla penetren accidentalmente dentro de la cámara de combustión durante el proceso, además de un cepillo de alambre de acero de pequeño calibre para limpiar la parte inferior DEL ASIENTO.

- Contiene:
 - 3 cepillos de latón.
 - 2 cepillos de silicona-nylon.
 - 1 extensor.
 - 6 tapones de cierre para el sellado de la cámara de combustión.
 - 1 varilla para la inserción de los tapones de cierre.
 - 1 cepillo de alambre de acero para la limpieza de la culata.



SET DE 3 CEPILLOS DE LATÓN PARA 53650

14348	0,05	50
12,50€	Kg	ff



SET DE 2 CEPILLOS DE SILICONA PARA 53650

14349	0,07	100
20,50€	Kg	ff

SET DE VASOS PARA BOMBA INYECTORA

53330 38,00€

0,75	-	20	144
Kg	Sub	ff	ff

- Bomba de inyección BOSCH.
- TDI.
- Common Rail.



Cr-V 1/2" 1/4" 5 PCS



CEBADOR INYECCIÓN DIESEL

52801 26,00€

0,10	5	50	600
Kg	Sub	ff	ff



- Durante la sustitución de la bomba de inyección, filtros u otras partes, evita el retroceso del combustible hacia el depósito.
- Posteriormente al montaje de las partes a sustituir permite bombear el combustible hacia la línea de inyección.

SET PARA EXTRACCIÓN Sonda LAMBDA

51491 154,00€

3,99	-	5	150
Kg	Sub	ff	ff

- 17x78mm (12PT): Renault, Audi, Seat, Mazda.
- 19x78mm (12PT): VW, Polo.
- 20x78mm (6PT): Deschis Japon.
- 27x78mm (6PT): Deschis Japon.
- 21x90mm (12PT): Seat, Audi, VW, Skoda, Alfa Romeo, Mitsubishi.
- 22x78mm (12PT): Seat, Audi, VW, Skoda, Opel.
- 22x110mm (12PT): Mercedes, Citroen, Peugeot, Ford, Nissan, Mazda, Mitsubishi, Seat, Audi, VW, etc.



14 PCS

LLAVE PARA EXTRACCIÓN Sonda LAMBDA

52822 32,00€

22mm

0,41	5	20	-
Kg	Sub	ff	ff

- Llave hexagonal con ventana, permite la extracción de sondas Lambda situadas en lugares de difícil acceso.



CABEZAL ARTICULADO



HERRAMIENTA DE EXTRACCIÓN E INSTALACIÓN DE INYECTORES DE COMBUSTIBLE PARA BMW MERCEDES BENZ

54220 197,00€

4,40	-	2	240
Kg	Sub	ff	Tr

MARCAS

BMW:
135is (2008-),335 (2007-),335xi (2007-),535i (2008-),535xi (2008-),550i GT (2010-),750Li (2009-)
750i (2009-), X3 3.0i (2007-),X5 (2011-),X5 3.0i (2008-),X6 (2008-)
MERCEDES-BENZ:
C-class (2007-),CLK / SLK (2007-),E-class (2007-),A / CLA / GLA 45 AMG (2013-),CL / CLS 63 AMG (2010-),E / G / GL 63 AMG (2011-),GLE 63 AMG (2015-),JS / SL 63 AMG (2010-),SLK 55 AMG (2012-)

HERRAMIENTAS OEM

BMW: 130180(1), 130195(2), 130270(3), 130320(4), 2249115(5)
Mercedes-Benz: 271589023300(6), 278589003300(7)

CÓDIGOS DE MOTOR

BMW : N14 / N18 / N20 / N47 / N54 / N57 / N55 / N63
Mercedes-Benz :M133 / M152 / M157 / M270 / M271 / M274 / M276 / M278



pg.183

SET REPARADOR DE ROSCAS INTERIORES Y EXTERIORES

54003 104,00€

1,60	-	10	270
Kg	Sub	ff	Tr

Medidas de rosca:

- M14x1,5
- M16x1,5
- M18x1,5
- M20x1,5
- M22x1,5
- M24x1,5
- M27x2,0
- M28x1,5



9 PCS

CrMo



SET DE 7 VASOS PARA EXTRACCIÓN DE Sonda LAMBDA

51119 62,00€

2,09	5	10	240
Kg	Sub	ff	Tr

1/2" 3/8"



- Contenido:

- Vaso de 1/2" de 29x9 a 90mm largo.
- Vaso de 1/2" de 7/8" a 50mm largo.
- Vaso de 1/2" de 27x12 a 78mm largo.
- Vaso de 3/8" de 7/8" x 6 a 90mm largo.
- Vaso de 3/8" de 7/8" x 6 a 80mm largo.
- Vaso de 3/8" de 7/8" a 30mm de largo.
- Vaso de 3/8" de 1" y 1-1/16" a 74mm largo.

KIT DE REPARACION DE TUERCAS HELICOIDALES

51896 82,00€

115 PCS

2,10	-	5	300
Kg	Sub	ff	Tr



REF.	DESCRIPCIÓN	Kg	Tr	€ / x5
52016	Recambio helicoil M5x0,8	0,01	10	2,10€
52017	Recambio helicoil M6x1,0	0,01	10	2,40€
52018	Recambio helicoil M8x1,25	0,05	10	2,60€
52019	Recambio helicoil M10x1,50	0,01	10	3,20€
52021	Recambio helicoil M12x1,75	0,02	10	3,40€

REF.	DESCRIPCIÓN	Kg	Tr	€ / x5
52022	Recambio helicoil M14x2,0	0,01	10	4,50€
52023	Recambio helicoil M16x2,0	0,01	10	6,60€
52024	Recambio helicoil M18x2,5	0,05	10	10,60€
52025	Recambio helicoil M20x2,5	0,01	10	13,00€



- Contiene por medida: Brocas, Machos, Insertador de Helicoil, Puntero de rotura, Set helicoils acero Inox.

- Contenido: 25 x M5x0.8, 25 x M6x1, 25 x M8x1.25, 25 x M10x1.5, 10 x M12x1.75

51897 122,00€

39 PCS

2,21	-	5	378
Kg	Sub	ff	Tr



- Contiene por medida: Brocas, Machos, Insertador de Helicoil, Puntero de rotura, Set helicoils acero Inox.

- Contenido: 9 x M12x1.75, 9 x M14x2, 9 x M16x 2.0

KIT DE REPARACIÓN DE ROSCAS

53041 37,60€

0,54	-	10	1000
Kg	Sub	ff	Tr

- ESPECIAL BUJÍAS.



M14x1,25



51898 139,00€

1,81	-	4	252
Kg	Sub	ff	Tr

M18x2,5

51899 137,00€

2,12	-	4	252
Kg	Sub	ff	Tr

M20x2,5



- Contiene:

- Broca, Terroja macho de acabado, Insertador de helicoil, Puntero de rotura, Set espirales acero inox.

ESTUCHE MÉTRICO CON 60 PIEZAS DE MACHOS Y TERRAJAS COMBINADO MÉTRICO Y PULGADA

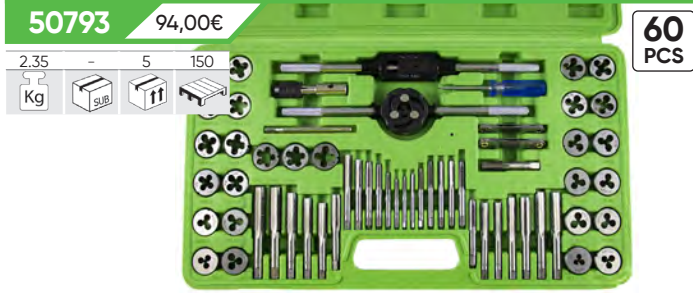

50793 94,00€

2.35 - 5 150

Kg SUB

1 Macho NPT (pulgadas): 1/8-27.
1 Terraja TNP (pulgadas): 1/8-27.
1 Porta machos mixto: M3 ~ M12 y 3/16" ~ 1/2".
1 Porta machos mixto tipo T: M3 ~ M6 6-32 y 4-40.
1 Porta terrajas mixto: Ø25mm.
1 Destornillador.
1 Juego de galgas métrico para roscar.
1 Juego de galgas en pulgadas para roscar.
10 Machos (métricos): M3x0.5, M4x0.7, M5x0.8, M6x1.0, M7x1.0, M8x1.25, M9x1.25, M10x1.0, M10x1.5, M12x1.75.

60 PCS

10 Machos UNC (pulgadas): 4-40, 6-32, 8-32, 10-24, 12-24, 1/4-20, 5/16-18, 3/8-16, 7/16-14, 1/2-13
6 Terrajas UNF (pulgadas): 10-32, 1/4-28, 5/16-24, 3/8-24, 7/16-20, 1/2-20.
10 Terrajas (métricas): M3x0.5, M4x0.7, M5x0.8, M6x1.0, M7x1.0, M8x1.25, M9x1.25, M10x1.0, M10x1.5, M12x1.75.
10 Terrajas UNC (pulgadas): 4-40, 6-32, 8-32, 10-24, 12-24, 1/4-20, 5/16-18, 3/8-16, 7/16-14, 1/2-13.
6 Terrajas UNF (pulgadas): 10-32, 1/4-28, 5/16-24, 3/8-24, 7/16-20, 1/2-20.

ESTUCHE MÉTRICO CON 58 PIEZAS DE MACHOS Y TERRAJAS RECUBIERTAS DE TITANIO



50792 105,00€

2.59 - 6 216

Kg SUB

1 Macho NPT: 1/8-27.
1 Terraja TNP (pulgadas): 1/8-27.
1 Porta machos mixto: M4 ~ M12.
1 Porta machos mixto tipo T: M3 ~ M6.
1 Porta terrajas mixto: Ø25mm O/D.
1 Destornillador.
1 Juego de galgas para roscar.

58 PCS

17 Machos: 2x0.4, 3x0.6, 3x0.5, 3.5x0.6, 4x0.75, 4x 0.7, 5x0.8, 6x0.75, 6x1.0, 7x0.75, 7x1, 8x1.0, 8x1.25, 10x1.25, 10x1.5, 12x1.25, 12x1.75.
17 Terrajas: 2x0.4, 3x0.6, 3x0.5, 3.5x0.6, 4x0.75, 4x0.7, 5x0.8, 6x0.75, 6x1.0, 7x0.75, 7x1, 8x1.0, 8x1.25, 10x1.25, 10x1.5, 12x1.25, 12x1.75.

COMPROBADOR UNIVERSAL DE FUGAS DE PRESIÓN PARA SISTEMA REFRIGERACIÓN



54139 147,00€

3.15 - 5 60

Kg SUB

Rango de presión: 0-2.5 BAR (0-35 PSI)
Adaptadores: 17-24 mm, 28-31.5 mm, 37-39.5 mm, 47-48.5 mm

5 PCS

Esta herramienta está diseñada para comprobar si es la presión en los circuitos del sistema de refrigeración es la adecuada. Usa el sistema de adaptador de cono universal para sellar y presurizar el sistema de enfriamiento, haciendo innecesario el uso de tapones adaptadores.

Incluye 4 adaptadores de cono universales que se adaptan a una gran gama de vehículos.

PROBADOR DE PRESIÓN Y VACÍO



53426 39,80€

0.90 4 16 160

Kg SUB

MEDIDOR DE PRESIÓN DE ACEITE

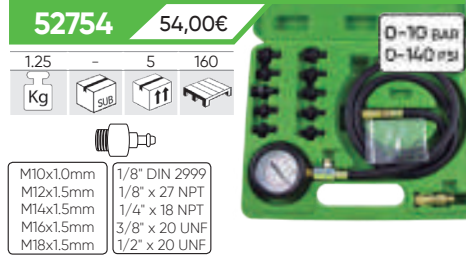

52754 54,00€

1.25 - 5 160

Kg SUB

M10x1.0mm 1/8" DIN 2999
M12x1.5mm 1/8" x 27 NPT
M14x1.5mm 1/4" x 18 NPT
M16x1.5mm 3/8" x 20 UNF
M18x1.5mm 1/2" x 20 UNE

- Útil para comprobar la presión de aceite y diagnosticar problemas en el sistema.
- Incluye 10 adaptadores que cubren la mayoría de vehículos del mercado.

MEDIDOR DE PRESIÓN DEL TURBO



53489 68,00€

0.70 5 10 260

Kg SUB

MEDIDOR DE COMPRESIÓN DIESEL PARA CAMIÓN



52685 88,00€

3.45 - 6 144

Kg SUB

- Kit completo para medir la compresión de vehículos diesel.
- Gran rango de adaptadores para medir en la mayoría de vehículos del mercado.
- Sistema de enganche rápido para

trabajos en puntos de difícil acceso.
- Adaptador en ángulo y adaptador a roscas de M18 y M24.
- Dispone de válvula de descarga y de sistema de retención de lectura.

MEDIDOR DE PRESIÓN GASOLINA



52488 28,00€

0.65 5 20 300

Kg SUB

- Reloj calibrado de doble lectura (0-300psi, 0-2000kpa) con válvula de descompresión.
- Su sistema de enganche rápido permite una medición rápida y exacta en puntos de difícil acceso; el adaptador cónico permite el uso en la mayoría de vehículos del mercado.

JUEGO DE ALICATES PARA DESCONEXIÓN DEL TUBO DE COMBUSTIBLE

53445 17,10€

0,35 12 48 576
Kg SUB



5/16"
8mm Ø



3/8"
10mm Ø



APLICACIÓN ESPECIAL



MEDIDOR DE PRESION PARA CIRCUITOS DE GASOLINA

53997 48,00€

1,40 - 5 150
Kg SUB

- Permite la detección de fallos en el sistema de combustible.
- Compatible con los sistemas de inyección Schrader.



1

2

3

1 Longitud: 25.5cm
Diámetro exterior: 1.2cm
Diámetro interior: 0.6cm

2 Longitud: 29.5cm
Diámetro exterior: 1.2cm
Diámetro interior: 0.6cm

3 Longitud: 110cm

MEDIDOR DE COMPRESIÓN DIESEL

52489 58,00€

2,15 - 6 144
Kg SUB

- Ford, BMW, Mercedes Benz, VW, Citroën, Mitsubishi, Toyota, Peugeot, Renault, Volvo, Mazda.

- Kit completo para medir la compresión de vehículos diesel.
- Gran rango de adaptadores para medir en la mayoría de vehículos del mercado.
- Sistema de enganche rápido para trabajos en puntos de difícil acceso.
- Adaptador en ángulo y adaptador a roscas de M18 y M24.
- Dispone de válvula de descarga y de sistema de retención de lectura.

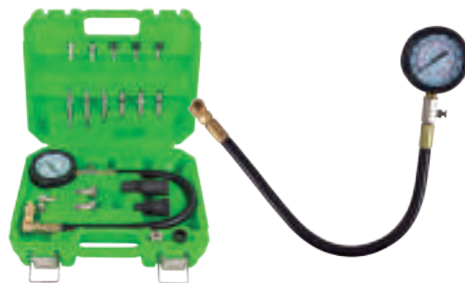

0-1000 PSI
0-70 Kgs/cm²

M18x1.5mm
M24x2.0mm
M24x1.5mm
M10x1.0x68mm
M10x1.25x54mm
M10x1.25x68mm
M12x1.25x45mm

MEDIDOR DE COMPRESIÓN DIESEL

51893 690,00€

4,25 - 3 54
Kg SUB

0-1000 PSI
0-70 Kgs/cm²



- Diagnóstico de compresión para sistemas de inyección diesel.
- Rango de trabajo hasta 70kg/cm² (1.000PSI).
- Reloj de medición recubierto en goma, con adaptadores en ángulo y prolongadores para trabajos en punto de difícil acceso.
- Apto para uso en la mayoría de motores diesel del mercado.

- Con adaptadores de gama Alfa, BMW, Chrysler, Daewoo, Fiat, Ford, Hyundai, Isuzu, LandRover, LDV, Mazda, Mercedes, Mitsubishi, Nissan, Opel, PSA, Renault, Suzuki, Saab, Toyota, VAG, Opel, Volvo diesel.
- Inyector: M20, M22, M24 y Ford.

MEDIDOR DE PRESION PARA CIRCUITOS DE COMBUSTIBLE

52599 230,00€

4,00 - 5 60
Kg SUB

0-145 PSI
0-1000 KPA
x2
3-1/2" 3-1/2"

- Contiene todos los elementos necesarios para comprobar la inyección de combustible en la mayoría de los coches.
- Cuenta con un gran manómetro de 3-1/2" con lecturas duales de 0-145 psi y 0-1000 KPA y un manómetro de 2-1/2" con lecturas duales.
- Todos los adaptadores, manómetros y conjuntos de mangueras cuentan con un sistema de acoplamiento rápido.



MEDIDOR DE COMPRESIÓN PARA DIESEL Y GASOLINA

53490 275,00€

5,50 - 2 40
Kg SUB

- Alfa Romeo, BMW, Chrysler, Citroen, Daewoo, Fiat, Ford, Honda, Hyundai, Isuzu, Jeep, Kia, Lada, Lancia, Land Rover, LDV, Mazda, Mercedes, MG, Mitsubishi, Nissan, Peugeot, Renault, Rover, Saab, Ssangyong, Suzuki, Toyota, VAG, Vauxhall/ Opel, Volvo.

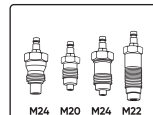

Ø 10, 12, 14, 18mm



SET REPARADOR DE ROSCAS DE CALENTADORES

52076 111,00€

0,85 - 10 36



- Herramienta de inserción - 2uds.
- Mango para pieza 8 - 1ud.
- Rosca M8 x 1,0 - 5uds.
- Rosca M10 x 1,0 - 5uds.
- Rosca M10 x 1,25 - 5uds.
- Rosca M12 x 1,25 - 5uds.
- Cabezales de inserción - 3uds.
- Varilla de inserción de rosca - 1ud.

- Inserción de corte M14 x 1,25 (para roscas de M12 x 1,25) - 1ud.
- Inserción de corte M12 x 1,25 - 1ud.
- Inserción de corte M12 x 1,0 (para roscas de M10 x 1,25) - 1ud.
- Inserción de corte M10 x 1,25 - 1ud.
- Inserción de corte M10 x 1,0 (para roscas de M8 x 1,0) - 1ud.
- Inserción de corte M8 x 1,0 - 1ud.

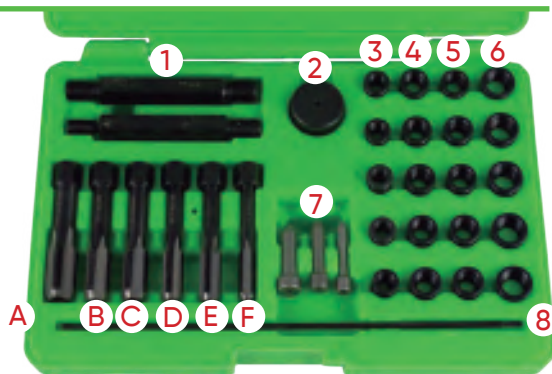

REF.	DESCRIPCIÓN	Kg	Sub	ff	€
11893	Helicoil M8x1,0	0,01	5		7,00€
11894	Helicoil M10x1,0	0,01	5		7,00€
11895	Helicoil M10x1,25	0,05	5		8,65€
11896	Helicoil M12x1,25	0,01	5		8,80€

EXTRACTOR / REPARADOR DE CALENTADOR

52305 106,00€

1,79 - 10 180



16 PCS

- Extractor de bujías de precalentamiento de 16 piezas.
- Este set es útil para la extracción del calentador roto o atascado. Universal e ideal para motores Mercedes-Benz CDI.
- Extrae los calentadores rotos o dañados M8 y M10.
- Incluye machos de rosca 1/4" M8 y broca escalonada de alta resistencia de doble tamaño M8 y M10.

JUEGO DE EXTRACTORES DE PUNTA DE ELECTRODO DE CALENTADORES

52815 110,00€

0,95 - 5 280



- Útiles especialmente diseñados para extraer puntas de electrodo de calentador en caso de rotura durante el proceso de extracción.
- Facilita la extracción sin necesidad de levantar la culata.

EXTRACTOR DE CONEXIONES DE CALENTADOR

52816 28,10€

0,27 - 6 36 -

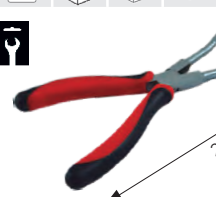

BOCA EN ÁNGULO

52817 23,50€

0,27 - 6 36 -

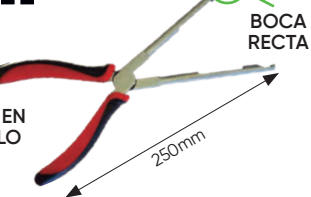

BOCA RECTA

- Alicates útiles para extraer los conectores en calentadores Diesel.
- Indicados para la extracción de forma rápida.
- Con los conectores localizados en puntos de difícil acceso, los alicates permiten realizar la operación sin riesgo de dañar el calentador u otras partes del vehículo.
- Mango engomado ergonómico.

SET DE VASOS TWIST DE 1/2" PARA EXTRACCIÓN DE TUERCAS / TORNILLOS SEGURIDAD

52153 46,00€

0,93 - 5 20 640



17, 19, 21, 23, 27mm

1/2"



SET DE VASOS TWIST DE 3/8" PARA EXTRACCIÓN DE TUERCAS / TORNILLOS SEGURIDAD

51998 38,00€

0,69 - 5 20 360

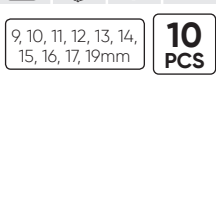

9, 10, 11, 12, 13, 14, 15, 16, 17, 19mm

10 PCS

52962 42,00€

0,75 - 5 20 1500



6, 8, 10, 11, 12, 13, 14, 15, 16, 17, 19mm

11 PCS

NUEVO DISEÑO: PARTE HEXAGONAL

3/8"

CR-MO

KIT DE EXTRACCIÓN DE TORNILLOS DE SEGURIDAD DE RUEDA

54253 166,00€

1,85	-	-	700
Kg	sub	fl	fl

Kit fácil de utilizar, capaz de desmontar cualquier tuerca de rueda con bloqueo. El kit incluye una cubierta que protege la rueda contra cualquier daño. Muy eficaz y una herramienta de taller imprescindible. Contiene dos tamaños de cuchillas de corte de impacto para adaptarse a la mayoría de tuercas de la rueda de bloqueo mediante el corte en el borde exterior. También se incluyen tres cuchillas de doble cara para moldear en la forma del zócalo directamente. Universal: Saca una amplia gama de tamaños, tipos y perfiles, incluidos los que tienen collares giratorios. Incluye destornillador de impacto y punzón.



UNIVERSAL **9 PCS**

SET DE TORNILLOS DE SEGURIDAD PARA BMW

53208 126,00€

0,95	5	20	-
Kg	sub	fl	fl

41-60 **BMW** **22 PCS**

- BMW Serie 1 F20/F21.
- BMW Serie 3 F30/F31.
- BMW Serie 4 F32/F34/F36.
- BMW Serie 5 F10/F11.
- BMW Serie 6 F12/F13.
- BMW Serie 7 F01/F02/F04.

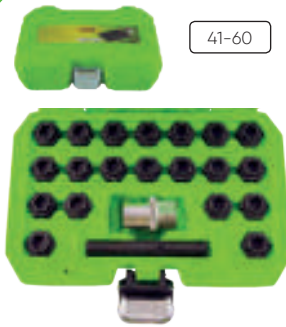

SET EXTRACTOR DE TORNILLOS DE SEGURIDAD PARA VW

53207 118,00€

1,55	5	10	330
Kg	sub	fl	fl

23 PCS **VW**

- | | |
|------------|-------------|
| b51 / 6pt | b62 / 17pt |
| b52 / 7pt | abc0 / 10pt |
| b53 / 8pt | abc1 / 11pt |
| b54 / 9pt | abc2 / 13pt |
| b55 / 10pt | abc3 / 14pt |
| b56 / 11pt | abc4 / 15pt |
| b57 / 12pt | abc5 / 16pt |
| b58 / 13pt | abc6 / 17pt |
| b59 / 14pt | abc7 / 19pt |
| b60 / 15pt | abc8 / 20pt |
| b61 / 16pt | abc9 / 21pt |



SET EXTRACTOR DE TORNILLOS DE SEGURIDAD PARA BMW

52802 54,00€

0,62	-	20	-
Kg	sub	fl	fl

- Útil para sacar los tornillos de seguridad. **10 PCS** **BMW**

- 30/13 PT,31/15 PT,32/16 PT,33/17 PT,34/18 PT,35/19PT,36/20 PT,37/21 PT,38/22 PT,40/23 PT



SET EXTRACTOR DE TORNILLOS DE SEGURIDAD PARA GRUPO VAG

52823 124,00€

0,94	5	20	-
Kg	sub	fl	fl

VAG **22 PCS** A, B, C, E, F, G, H, I, J, L, M, N, P, Q, R, S, T, V, W, X

- Set especialmente diseñado para extraer los tornillos de seguridad en llantas de vehículos Volkswagen.
- Cubren prácticamente el 100% de la flota de vehículos VW del mercado.
- Sirve para el 100% de vehículos con tornillo antirobo tipo "flor".

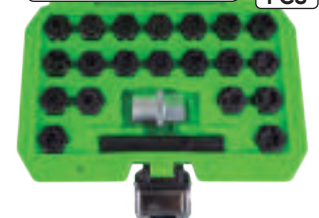

SET DE TORNILLOS DE SEGURIDAD PARA MERCEDES

53328 76,00€

0,60	5	20	-
Kg	sub	fl	fl

MERCEDES 5A, 5C, 5D, 5E, 5F, 5G, 5N, 5L, 5P, 5X **12 PCS**

- Clase A, B, C, GLK, CLC, CLS, CLK, E, SL, SLK, M, C300, C250, C350, E320, 204, 211, 212, R.



SET DE REPARACIÓN DE ROSCAS PARA TORNILLOS DE RUEDA

53652 53,00€

0,94	5	10	240
Kg	sub	fl	fl

- M12x1.25 - **PSA**
 M12x1.5 - **MERCEDES BENZ / BMW**
 M12x1.75 - **VOLVO**
 M14x1.5 - **VAG**



- Set de útiles para reparar y reacondicionar tornillos de rueda, así como el anclaje del mismo a la rosca hembra del vehículo; útil en roscas parcialmente dañadas.

EXTRACTOR DE BOBINA DE ENCENDIDO PARA VW

51495 59,00€

0,96	-	20	200
Kg	sub	fl	fl

VW

- Quitar e instalar las bobinas de encendido con tapa de motores de inyección VW CYL 8 y 12 / 5 y 6 CYL, VW GOLF, BORA, 4 y 5 CYL, VW Passat, 6 CYL, Sharan VW, Touareg, Phaeton.
- Extraer e instalar las bobinas de encendido con etapa de potencial VW Polo, Golf 1.4, 1.6i, 1.4i CADDY, BORA 1.4, 1.6i Phaeton, Passat, Touran 1.6i, Transporter T4.



DESPIECE DISPONIBLE



DISCO REPARADOR

REF.	DESCRIPCIÓN	Kg	fl	€
14344	M12x1.25	0,49	20	11,00€
14345	M12x1.5	0,50	20	11,00€
14346	M14x1.5	0,46	20	11,00€



TORNILLO REPARADOR

REF.	DESCRIPCIÓN	Kg	fl	€
14340	M12x1.25 - PSA	0,05	20	10,50€
14341	M12x1.5 - MERCEDES / BMW	1,14	20	10,50€
14342	M12x1.75 - VOLVO	1,12	20	10,50€
14343	M14x1.5 - VAG	1,29	20	10,50€

SET DE EXTRACTORES DE TORNILLOS

51496 8,00€

5
PCS

0.12	12	72	2016
Kg	Sub	ff	

- Nº 1: 1/8" - 1/4" (M 3-6)
- Nº 2: 1/4" - 5/16" (M 6-8)
- Nº 3: 5/16" - 7/16" (M 8-11)
- Nº 4: 7/16" - 9/16" (M 11-14)
- Nº 5: 9/16" - 3/4" (M 14-18)



- Fabricados a partir de un tratamiento térmico de acero al cromo molibdeno.
- Consigue una rápida eliminación con la ayuda de las hélices actuando como tornillo.

SET DE EXTRACTORES DE MACHOS DE ROSCAR ROTOS

53502 38,70€

9
PCS

0.55	5	20	900
Kg	Sub	ff	

- #2 M5
- #3 M6
- #4 M8
- #5 M10
- #6 M12
- #7 M14
- #8 M16
- #9 M20
- #10 M22



SET DE ABOCARDADO DE TUBERÍAS

52700 20,50€

3/16, 1/4, 5/16, 3/8, 1/2

0.95	6	12	468
Kg	Sub	ff	

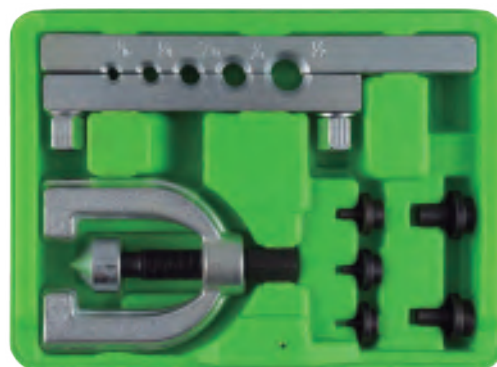

SET VASOS EXTRACTORES DE ESPÁRRAGOS DE 1/2"

52833 39,30€

1/2"

0.80	5	20	-
Kg	Sub	ff	



6, 8, 10, 12mm

DESPIECE DISPONIBLE

REF.	DESCRIPCIÓN	Kg	Sub	ff	€
14211	6mm	0,10	20	100	11,00€
14212	8mm	0,10	20	100	12,00€
14213	10mm	0,20	20	100	12,00€
14214	12mm	0,20	20	100	14,00€

LLAVES DE BUJÍA ARTICULADAS

52691 54,00€

8, 9, 10, 12, 14, 16mm

3/8"

0.79	6	24	480
Kg	Sub	ff	



CON SISTEMA MECÁNICO DE SUJECIÓN



LLAVE DE BUJÍA IMANTADA

52317 19,90€

250mm 3/8"

0.30	12	72	2880
Kg	Sub	ff	

Ø16mm

52316 18,90€

0.20	12	48	2880
Kg	Sub	ff	

Ø14mm



VASO DE BUJÍA HEX.

10054 2,90€

10055 3,90€

1/2"

0.08	10	100	-
Kg	Sub	ff	

0.14	10	100	-
Kg	Sub	ff	

16mm

21mm



GOMA EN EL INTERIOR



SET DE EXTRACCIÓN DE POLEAS DE 30 PIEZAS

52293 98,00€

3.11	-	5	120
Kg	SUB	↑	↑

- 1/2" T50 c/33 dientes 17mmx33T - 113mmL.
- 1/2" M10 c/33 dientes 17mmx33T - 113mmL.
- H15x33 dientes 15mmx33T - 31mmL.
- H22x33 dientes 22mmx33T - 30mmL.
- H22 - 30mmL.
- H17x4 Pins especial H17x4Pins - 30mmL.
- 1/2"Dr. xH10 Bit adaptador.
- H8xH10 Punta 75mmL.
- H10xH10 Punta 75mmL.
- M8xH10 Punta 75mmL.
- M10xH10 Punta 75mmL.
- T40 xH10 Punta 75mmL.
- T50xH10 Punta 75mmL.
- M10xH12 Punta 64mmL.
- Especial H22xH28 - 30mmL.

- Especial H19xH28 - 30mmL.
- 1/2"Dr.xM10 punta M10 - 143mmL.
- 3/8"Dr.xM10 c/31 dientes - 12mmx31T- 83mmL.
- Especial H21xH28 - 30mmL.
- Especial H17 - 35mmL.
- Especial H38x3 Pins-17mmL.
- Especial 15mmx33T- 30mmL.
- H10xFH10 - 71mmL.
- T50xH12 Bit 64mmL.
- Especial H17xH21-30mmL.
- Especial H15xH28 - 30mmL.
- 3/8"Adaptador x10mm.
- 1/2"Dr.xT50 punta T50 - 143mmL.
- 1/2"Dr.xT50 punta T50 - 204mmL.
- 1/2"Dr.xM10 punta T50 - 204mmL.

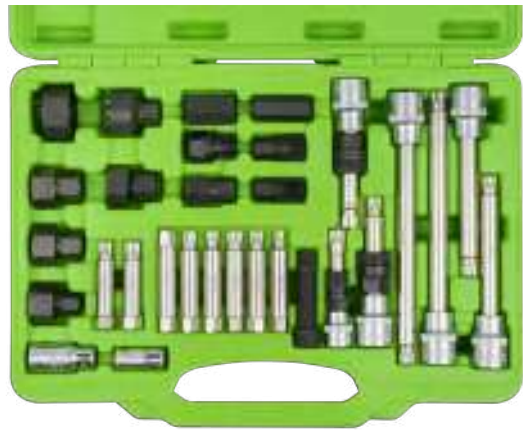

30
PCS

JUEGO DE EXTRACTOR POLEAS DE 18 PIEZAS

51259 58,00€

2.10	-	10	240
Kg	SUB	↑	↑

- 3 x Vasos combinados: T50x113mm (vaso de 1/2"), M10x113mm (vaso de 1/2"), M10x90mm (vaso de 3/8").
- 1 x Vaso dentado: M10x140mm.
- 2 x Adaptadores hexag. 19 y 22mm.
- 3 x Vasos hexagonales: 22x28mm, 19x28mm, 21x28mm.
- 1 x Adaptador Hex. 1/2" x 10mm.
- 1 Punta M10x12x64L.
- 6 x Puntas 10mm (vasos hex.) x 75mm: Medidas: T40, T50, M8, M10, H8, H10.



18
PCS

DESPIECE DISPONIBLE



10494 6,50€

VASO ALARGADOR
14cm



10495 3,00€

PUNTA H10



10496 3,00€

PUNTA H8



10497 3,00€

PUNTA M10



10498 3,00€

PUNTA M8



10499 3,00€

PUNTA T40



10500 3,00€

PUNTA T50



10501 8,10€

VASO PUNTA
XZN M10 90mm

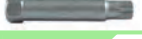

10502 3,50€

PUNTA M10 TORX



10485 8,10€

VASO PUNTA
XZN M10 110mm

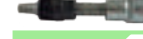

10486 8,00€

VASO PUNTA
TORX T50 110mm

JUEGO DE LLAVES CURVADAS PARA EXTRACCIÓN CORREAS 12 CANTOS

52832 75,00€

1.25	-	5	200
Kg	SUB	↑	↑



12, 13, 14, 15, 16,
17, 18, 19mm



CABEZAL
INTERCAMBIABLE

PALANCA PARA AFLOJAR CORREAS

52690 54,00€

1.54	-	10	280
Kg	SUB	↑	↑

- Palanca de 230mm con cuadrado de 1/2".
- Palanca de 585mm con cuadrado de 3/8".
- 3 llaves abiertas de 13, 14, 15mm y con cuadrado de entrada de 3/8".
- 4 vasos hexagonales de 3/8" y 13, 15, 16, 18mm.

3/8"

1/2"



13, 15, 16,
18mm



13, 14,
15mm



1/2" 230mm

3/8" 585mm

EXTRACTOR DE TUERCAS

51368 19,00€

0,41	5	50	1000
Kg	Sub	ff	ff

∅
↑ 42mm
↓ 33mm



EXTRACTOR DE TUERCAS AXIALES

51369 28,00€

0,55	6	36	756
Kg	Sub	ff	ff

∅
↑ 42mm
↓ 35mm



EXTRACTOR PARA ESPÁRRAGOS

51414 14,00€

0,59	5	40	1440
Kg	Sub	ff	ff

∅
↑ 20mm
↓ 15mm



ALINEADOR DE CAIDAS (VAG)

53488 61,00€

2,75	-	5	200
Kg	Sub	ff	ff

- Permite que una sola persona ajuste del ángulo de caída de la rueda.

- Incluye:
husillo hexagonal de 22mm
3 longitudes distintas para:
- 75mm: Seat - Toledo | VW-Jeta/Golf.
- 85mm: Seat - Cordoba | VW-Polo/95>.
- 115mm: Chrysler - Voyager.



COMPROBADOR ANGULAR DE CAÍDA IMANTADO

52318 73,00€

0,64	6	24	336
Kg	Sub	ff	ff

-6° / +6°

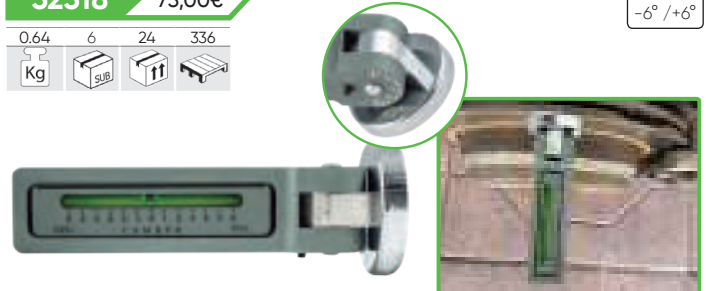

EXTRACTOR DE POLEAS ARMÓNICO

52624 28,00€

1,25	-	5	450
Kg	Sub	ff	ff

- Contiene:
2 x tornillo 5/16" de 4".
2 x tornillo 1/4" de 3".
3 x tornillo 1/4" de 2".
3 x tornillo 5/16" de 2".
1 x 5" tornillo de presión de aleación de aluminio.
1 x punta giratoria 3/4".



EXTRACTOR DE POLEAS ACANALADAS

51500 29,00€

1,55	-	10	640
Kg	Sub	ff	ff

40-168mm

- Apto para el uso en cigüeñales, alternadores, unidades de AACC y bombas de agua.
- Los brazos del perfil bajo permiten un fácil acceso a zonas difíciles del motor.
- Diseñado para la extracción del cigüeñal acanalado, agarrotado y de poleas auxiliares.



EXTRACTOR DE POLEAS UNIVERSAL

53664 38,00€

0,80	-	10	2500
Kg	Sub	ff	ff

- Uso universal.
- Opción de multiposición para adaptarse a la mayoría de poleas.
- Ideal para trabajar en áreas estrechas, ahorrando tiempo de trabajo.

- Medidas:
Eje de 16mm de diámetro con bola centradora y cabeza de tornillo hexagonal de 24mm.



ÚTIL DE EMBRAGUE ESPECIAL FIAT

52190 8,00€

220x110mm

0,39	-	10	1000
Kg	Sub	ff	ff

- Especificaciones:
Facilita el acceso al vástago de la horquilla para su extracción y la posterior sustitución del disco.
Útil para desmontar la horquilla en embragues de Fiat Ducato.
Reduce el tiempo de trabajo.
Evita desmontar el cambio para cambiar el embrague.
- Rosca: 1,5cm de largo x ∅ 0,5cm.



GANCHOS PARA EXTRACCIÓN DE JUNTAS

53053 12,00€

0,21	10	50	1000
Kg	Sub	ff	ff

1x15,5cm / 1x16,5cm / 1x12cm



PALANCA DE AJUSTE PARA BRAZO DE SUSPENSIÓN

51902 84,00€

4,90	-	1	66

- Medidas:
118cm largo.
Ø Diám. Tubo: 3,5cm.
Distancia de anclajes:
50, 45, 40, 35, 30 cm.
Anclaje de 15x13cm.



RECAMBIO DE ANCLA DE SUJECIÓN PARA REF. 51902

10953 12,50€



KIT DE HERRAMIENTAS PARA EXTRACCIÓN DE BRAZOS DE DIRECCIÓN

52639 123,00€

5,05	-	4	84

Ø 30-35mm
Ø 35-40mm
Ø 40-45mm



ALINEADOR DE DIRECCIÓN

51991 48,00€

1,15	-	10	120

- Largo total abierto: 1950mm.
- Largo total cerrado: 1100mm.
- Medida de tornillo: M6x15mm.
- Tubo exterior de 20x20 de aluminio.
- Tubo interior de 16x16 de hierro cincado.

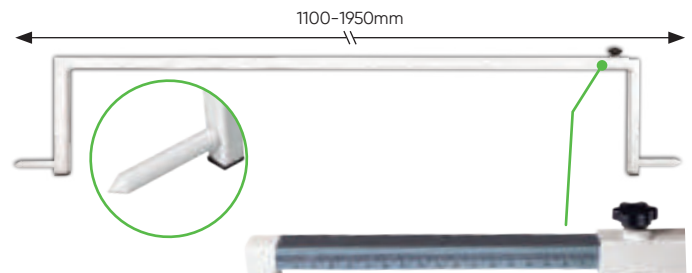

HERRAMIENTAS EXTRACCIÓN BRAZO DE DIRECCIÓN

52640 52,00€

1,80	-	4	256

Ø 28-35mm

52641 55,00€

2,20	-	4	140

Ø 35-45mm



EXTRACTOR DE BRAZOS DE DIRECCIÓN

52874 82,00€

1,20	4	20	1500

Ø 9-20mm

52875 79,00€

1,25	5	20	1500

Ø 14-23mm



SET DE 12 PIEZAS PARA LA EXTRACCIÓN DE AIRBAGS

51501 38,00€

0,88	5	20	240

- Puntas 0.5 PC 1/4" x 87mm (L):
2x Torx: T25 (para BMW), T30 (para Audi, Opel, Renault, VW).
2x Torx (inviolable): T25H (Para BMW), T30H (Para AUDI, BMW, Mercedes, Opel).
1x Hex: 5 mm (Para Audi).

- 0.7 PC Herramienta extracción:
1x para Airbag conductor. 1999-04 nuevo estilo de carrocería de VW Passat, Jetta, Golf.
2x para VW Passat B5, Polo, Lupo; Audi A4, A6, Skoda Superb.
2x para VW Golf 4, New Beetle, Seat, Skoda Fabia, AB Oktavia BJ.99.
1x para Para VW Golf 4 (BJ. 1998-2004), VW Passat BJ.1997 AB, AB Bora BJ.1999.
1x para U.A VW-Modelle: AB Passat BJ.2000.

12 PCS

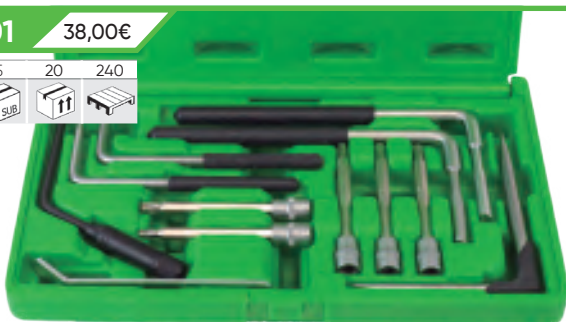

EXTRACTORES

EXTRACTOR DE RÓTULAS HIDRÁULICO

53384 165,00€

7.30	-	2	74
Kg	sub	ff	tr



- Apertura: 100mm.
- Ancho: 35mm.

10kg



1 1/2"-16UNF

M20X1.5



HUSILLO

15253

62,00€

JUEGO DE 5 EXTRACTORES DE RÓTULA

51123 91,00€

5.29	-	2	136
Kg	sub	ff	tr



- Permite la fácil extracción de los tipos más populares de articulaciones de rótula y demás.
- El tipo de separador de la prensa de la junta permite el retiro de la junta de rótula sin daño a los cargadores y a otras piezas que otro tipo de extractores pueden causar.

SET EXTRACTOR-SEPARADOR DE RÓTULA

51490 36,00€

1.88	-	5	300
Kg	sub	ff	tr



- Horquillas hechas de acero cromo vanadio forjado de alta resistencia.
- Ambos mangos son intercambiables.
- 1 mango diseñado para utilizarse con martillo neumático.

- Contenido:
1 mango para su uso con un martillo.
3 horquillas: 11/16, 15/16" y 1-1/8".

COMPROBADOR MECÁNICO DE RÓTULAS

52541 45,00€

2.10	-	10	110
Kg	sub	ff	tr



- Para detectar juego en: Cojinetes, silentblocks, cojinetes de rueda, articulaciones axiales, palieres, estabilizadores, etc.

EXTRACTOR UNIVERSAL DE BOLA

52642 32,00€

1.32	5	20	600
Kg	sub	ff	tr

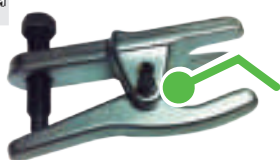

- Apertura Max: 60mm.
- Apertura Min: 20mm

17 - 22mm

2 MEDIDAS AJUSTABLES

EXTRACTOR DE RÓTULAS

52699 22,00€

0.80	5	30	1050
Kg	sub	ff	tr



- Apertura: 15-50mm.

Ø 18-22mm

JUEGO DE EXTRACTORES DE GUILLOTINA

51125 88,00€

4.72	-	5	160
Kg	sub	ff	tr

Capacidad de las guillotinas:

- Set Pulgada: 1/4", con 30mm y 50mm. Tornillo de 3/8" de 95x125 - 24 UNF. Cabeza de 3/8" x 16 UNC.

- Set 2 Pulgadas: 1/4" - 3 1/2", con 50x75mm. Tornillo de 1/2" de 12.7x135 20 UNF. Cabeza de 3/8" x 16 UNC.



EXTRACTOR DE GUILLOTINA

52626 46,00€

3.65	-	5	800
Kg	sub	ff	tr

75 - 105mm

52627 120,00€

6.50	-	2	231
Kg	sub	ff	tr

105 - 150mm

- Para extraer rodamientos en coches y vehículos comerciales ligeros.
- Extrae cajas de cambio, poleas y volantes fácilmente.



VASOS PUNTA XZN ESP. VAG

12029 5,50€

0.17	5	100	1500
Kg	sub	ff	tr



INVIOLEBLE M16X58MM



12030 6,50€

0.25	8	80	-
Kg	sub	ff	tr



INVIOLEBLE M16X100MM



CrV

1/2"



EXTRACTOR DE COJINETES CON 2/3 GARRAS INTERCAMBIABLES

53701 188,00€

8,45 Kg 1 SUB 1 44

13
PCS

- Rango extractor 2 patas: 45-120mm.
- Rango extractor 3 patas: 50-130mm.
- Profundidad de las garras: 100, 200, 250mm.
- Contiene:
Guía central de 3 garras.
Guía central de 2 garras.
Espárrago de 275mm.
Espárrago de 165mm.
Garras de agarre largo: 250mm.
Garras de agarre medio: 200mm.
Garras de agarre corto: 100mm.



PUNTA GARRA PARA REF. 53701

14611 0.10 50
12,00€ Kg

TORNILLO PARA REF. 53701

165mm

14612 0.15 20
11,00€ Kg

TORNILLO PARA REF. 53701

275mm

14613 0.30 20
13,50€ Kg

JUEGO DE EXTRACCIÓN DE COJINETES

51124 88,00€

3,20 Kg 5 SUB 120

- Contiene:
Extractor Universal (38,5mm).
Adaptador de 3/8" a 1/2" (10-14mm).
Adaptador de 9/16" a 11/16" (15-19mm).
Adaptador de 5/8" a 1" (18-25mm).
Adaptador de 1" a 1 1/4" (25-32mm).



EXTRACTOR DE TERMINALES CON 6 CONECTORES

54112 18,00€

0,04 Kg 20 SUB 100 1800

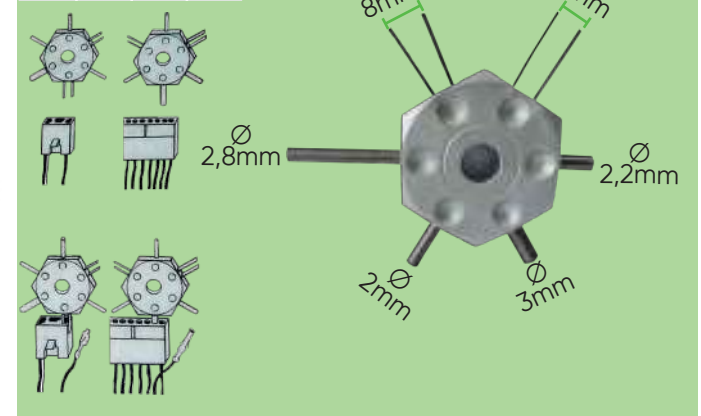

EXTRACTOR UNIVERSAL PARA INTERIORES/EXTERIORES

53250 85,00€

4,80 Kg 4 SUB 72

- Material: Cromo molibdeno SD45C.
- Para motores VW, Audi DIESEL.
- Aplicaciones: 1.4 SDI, TDI, 1.9 D, SDI, TDI, TDI (PD), 2.0 TDI (PD) & (PD 4-VALVES), 2.5 TDI / TDI(PD), 2.8 TDI (PD), 2.7, 3.0 TDI (Common Rail), 4.2 TDI (Common Rail).

- Material: acero.
- Extracción externa: de 40 a 80mm.
- Extracción interna: de 50 a 150mm.
- Incluye:
Extractor de triple garra exterior.
Triple garra int. para extracción de rodamientos.
1 extractor profundo.
1 conector de tornillo.



EXTRACTOR DE COJINETES CON ESFERAS FALSAS

53062 99,00€

2,41 Kg 10 SUB 160

5, 6, 8, 9, 11, 12,5mm

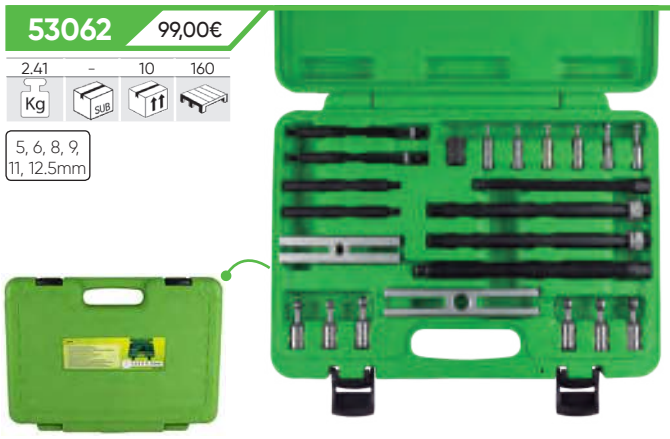

IVA no incluido

EXTRACTORES

EXTRACTOR DE DOS PATAS

52727 34,60€

0,20	10	60	1200
Kg			

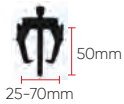

52728 68,00€

120	5	10	500
Kg			

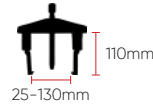

52727



EXPOSITOR DE EXTRACTORES DE RÓTULA

53146 30,50€

0,70	5	10	140
Kg			



52728

52729

52730

- Extractores no incluidos.

52729 128,00€

3,39	-	3	240
Kg			

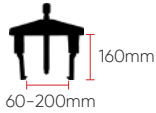

52730 288,00€

8,57	-	2	108
Kg			

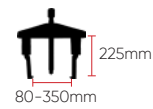

EXTRACTOR DE TRES PATAS

52731 38,00€

5,30	4	24	504
Kg			

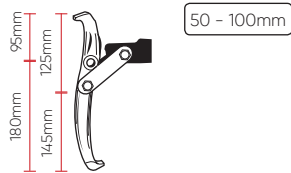

52732 58,00€

2,54	5	20	200
Kg			

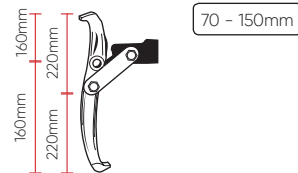

52733 98,00€

5,20	-	4	112
Kg			

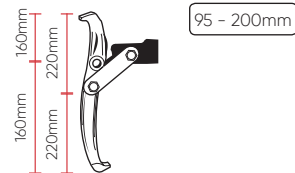

EXTRACTOR DE 3 GARRAS CONVERTIBLE REVERSIBLE

52010 80,00€

0,50	4	40	360
Kg			

- Medida de la Garra: 90mm.
- Medida del pasador: 124mm.
- Uña de agarre: 12mm.
- Ancho de la cruz: 66mm.
- Profundidad: 75mm.



52296 119,00€

1,57	4	8	120
Kg			

- Medida de la garra: 132mm.
- Medida del pasador: 217mm.
- Uña de agarre: 14mm.
- Ancho de la cruz: 95mm.
- Profundidad: 110mm.



52298 177,00€

2,65	3	6	396
Kg			

- Medida de la garra: corta 134mm, larga 207mm.
- Medida del pasador: 218mm.
- Uña de agarre: corta 13mm, larga 15mm.
- Ancho de la cruz: 95mm.
- Profundidad: 110 - 180mm.

GARRA CORTA Y LARGA



52297 172,00€

3,33	-	6	36
Kg			

- Medida de la garra: 210mm.
- Medida del pasador: 313mm.
- Uña de agarre: 15mm.
- Ancho de la cruz: 152mm.
- Profundidad: 180mm.



SET DE 52 PIEZAS PARA EXTRACCIÓN DE EQUIPOS DE AUDIO

53388 90,00€

1,50	-	5	120
Kg			

52
PCS



JUEGO DE ACCESORIOS PARA EXTRACCIÓN DE EQUIPOS AUDIO

51126 18,00€

0,20	10	100	1500
Kg			

10
PCS



- Blaupunkt, Clarion, Skoda, BMW, Audi, Grundig, JVC, Pioneer, Volkswagen, Mercedes, Opel Doppel-Kugel-Inbus, Porsche, Becker, Kenwood, Sony, Panasonic, Fiat Brava, Ford.

- Blaupunkt, Peugeot, Clarion, Skoda, Alpine, BMW, Opel, Audi, Grundig VDO, JVC, Pioneer, Volkswagen, Mercedes, Porsche, Renault, Becker.

SET DE 23 EXTRACTORES DE TERMINALES

53393

118,00€

23
PCS

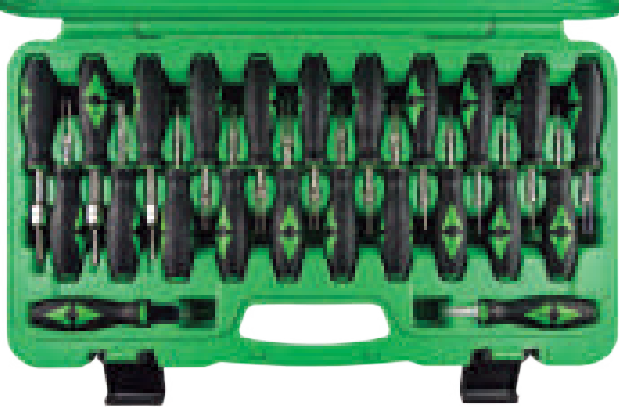
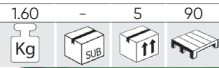

- BMW, Audi, Volkswagen, Mercedes, Opel, Porsche, Jaguar, Saab, Seat, Ford, Skoda, Renault, Citroën, Chrysler, Fiat, Honda, Mazda, Mitsubishi, Toyota.

SET DE 19 EXTRACTORES DE TERMINALES

53391

86,00€

19
PCS

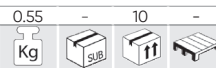

A, B, C, D, E, F, G, H, I, J, K, L,
A1, B2, C3, D4, E5, F6, G7

EXTRACTOR DE SILENTBLOCK DELANTEROS PARA VAG

52432

35,00€

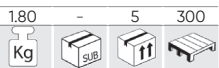

- Útil para VW POLO modelo 2002.
- Facilita el cambio de los bujes de goma del eje delantero.

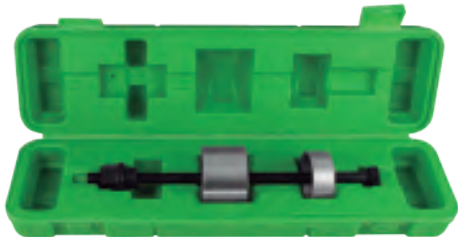

EXTRACTOR DE SILENTBLOCKS PARA VAG

52270

109,00€

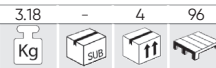

- Contiene:
Eje, extensión de eje, tuerca de empuje M10x1,25. Cabezal adaptador de acero al carbono. Separador. Pieza de presión. Mandril de centrado de aleación de aluminio.



SET DE VASOS CON ALMENAS EXTERIORES

52834

195,00€

11
PCS

- Set de vasos para la extracción de tuercas ranuradas en **vehículos industriales**.

1/2"

CR-MO

mm
22x3.3
26x3.8
30x4.3
33x4.0
37x4.8
44x5.3
50x5.8
56x5.8
63x6.3
69x6.8
75x6.8



SET DE VASOS CON ALMENAS INTERIORES

52835

272,00€

10
PCS

- Set de vasos para la extracción de tuercas ranuradas en **vehículos industriales**.

1/2"

mm
26x5.3
1.2x6.25
34.2x6.3
42.2x7.3
50.1x8.25
58.2x9.8
74.6x11.9
82.2x13.25
87.7x13

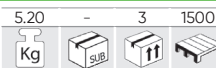

EXTRACTOR UNIVERSAL DE RETIRADA / INSTALACIÓN DE BUJES, RODAMIENTOS Y SILENTBLOCK

52494 227,00€

17.35 - 1 48
Kg SUB ff



- Para instalar y desinstalar casquillos y cojinetes de suspensión.
- Contiene manguitos de diferentes tamaños y barras roscadas de diferentes métricos.
- Medidas: M10, M12, M14, M16, M18.

12926
21,50€ M10



12927
21,50€ M12



12928
22,00€ M14



12929
23,00€ M16



12930
23,50€ M18



JUEGO DE DISCOS DE MONTAJE PARA RODAMIENTOS

53058 193,00€

8.19 - 1 102
Kg SUB ff



220mm Ø 12mm

Ø
18, 19, 20, 21, 22, 23, 24,
25, 26, 27, 28, 29, 30, 31,
32, 33, 34, 35, 36, 37,
38, 39, 40, 41, 42, 43,
44, 45, 46, 47, 48, 49,
50, 51, 52, 53, 54, 55,
56, 57, 58, 59, 60, 61, 62,
63, 64, 65, 74mm

JUEGO DE EXTRACCIÓN E INSTALACIÓN DE RODAMIENTOS

53056 127,00€

8.32 - 2 64
Kg SUB ff

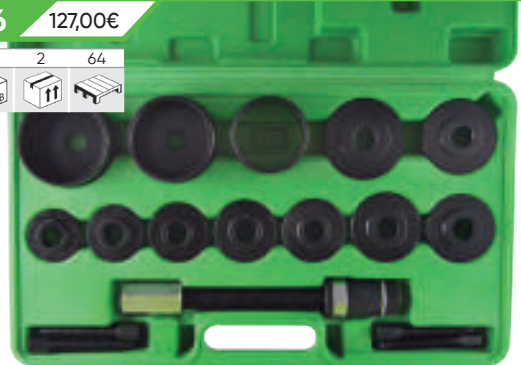

Ø 55.5, 59, 62, 65, 66,
71.5, 73, 78, 84mm

Ø 75.5, 83mm

295mm Ø 69mm

JUEGO PARA LA INSTALACIÓN DE RODAMIENTOS

51349 37,30€

1.00 - 10 180
Kg SUB ff

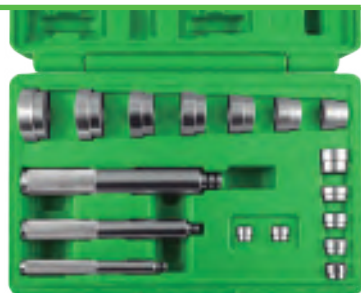

42 - 38mm
40 - 35mm
36 - 32mm
30 - 28mm
24 - 22mm
27 - 25mm
18 - 16mm
20 - 18mm
22 - 20mm
12 - 10mm
14 - 12mm
16 - 14mm
17 - 15mm

- Adaptadores de mantenimiento para tuerca estriada.
- Apto para todo tipo de buje y rodamiento.

INSTALADOR AJUSTABLE DE RETENES

53129 84,00€

0.96 2 10 180
Kg SUB ff

18 - 90mm



KIT EXTRACCIÓN E INSTALACIÓN RODAMIENTOS

52551 151,00€

10.42	-	2	58

- Tornillo reforzado para uso con herramienta de impacto.
- Eje de acero-fosfato para evitar la corrosión.
- Adecuado para desmontar e instalar grandes rodamientos industriales.
- Perno: 27mm
- Tuerca: 32mm
- Cilindros: 76, 82, 92, 101mm



Número	955-08	955-11	955-07	955-12	955-13	955-14	955-09	955-15	955-06	955-17	955-18	955-19	955-16
Diámetro (mm)	55.7	63.3	67.8	70.7	71.9	71.7	72.8	73.4	74.7	77.4	81.4	83.3	88.4

JUEGO PARA LA INSTALACIÓN DE RODAMIENTOS Y RETENES

53059 52,00€

1.70	5	10	160

∅
39,5, 44,5, 50, 59, 63,
65, 72, 76, 81mm



JUEGO DE EXTRACCIÓN E INSTALACIÓN DE BUJES Y RODAMIENTOS

54299 227,00€

15.00	-	1	-



	8,6x10,9cm		8,9x17,6cm
	8,2x10cm		9,9x 17,6cm
	7,1x9,45cm		12x17,8cm

∅ 2,3mm

	5,3cm		5,8cm		6,5cm		6,6cm		6,8cm
	7,1cm		7,3cm		7,8cm		8,3cm		
	9,5cm		∅ 2,3cm		9,55cm		∅ 8,6cm		

19
PCS



EXTRACTOR DE JUNTAS HOMOCINÉTICAS

51364 26,00€

2.00	-	5	280

∅
31mm 140 - 240mm



EXTRACTOR ROSCADO PARA POLEA DE CIGÜENAL

51140 64,00€

1.02	-	24	290

- Diseñado para sostener la polea del árbol de levas inmóvil mientras que se afloja.
- Permite el ajuste del eje central cuando se acoplan, usando la barra atornillada centrada para desraigar la polea.
- Tornillos de fijación: M6, M8.



KIT DE LIMPIEZA DE BUJES DE 14 PIEZAS

54069 29,50€

0.20	10	40	360
Kg	Sub	ff	ff

Elimina la suciedad superficial y la corrosión en los bujes equipados con espárragos.

- 1PC Adaptador de 1/2" cuadrado de 8mm.
- 1PC muela con eje de transmisión redondo de 8mm.
- 2PC almohadillas de gancho y bucle de repuesto con la parte posterior autoadhesiva.
- 5 discos de limpieza de grano grueso, con un diámetro exterior de 40 mm.
- 5 discos de limpieza de grano fino de 40 mm de diámetro exterior y 14 mm de diámetro interior.



EXTRACTOR DE BUJES HIDRAULICO

53638 243,00€

13.35	-	1	32
Kg	Sub	ff	ff

- Este kit incluye: 3 extractores / martillos: husillo hidráulico, tornillo y martillo de impacto, diseñados especialmente para simplificar la extracción del cubo de la rueda y liberar el eje del buje sin dañarlo.
- Con una capacidad máxima de 10 TON.
- Martillo de 4kg.
- Longitud de la barra: 57cm.
- Para 3, 4, 5, y 6 agujeros.

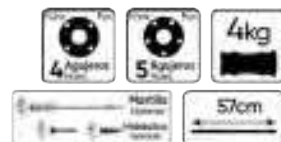

VAG (VW, AUDI, SEAT, SKODA), PSA (CITROËN, CITROËN DS, PEUGEOT), RENAULT, FORD, OPEL, BMW, MERCEDES BENZ

HUSILLO

15253 62,00€

EXTRACTOR DE BUJES CON MAZA DESLIZANTE

53635 85,00€

6.50	-	2	80
Kg	Sub	ff	ff

440 - 630mm

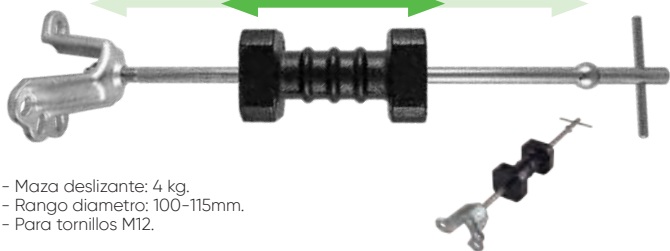

- Maza deslizante: 4 kg.
- Rango diámetro: 100-115mm.
- Para tornillos M12.

KIT EXPANSIÓN PARA SISTEMAS DE ESCAPE

52637 48,00€

3.01	-	5	220
Kg	Sub	ff	ff

1-1/8" - 1-3/4"
1-1/2" - 2-1/2"
2-1/8" - 3-1/2"



SET DE 2 GANCHOS PARA EXTRAER GOMAS EN TUBO DE ESCAPE

52849 8,50€

0.22	10	40	480
Kg	Sub	ff	ff



SET EXTRACTOR DE BRAZO LIMPIAPARABRISAS

53463 98,00€

1.65	-	10	180
Kg	Sub	ff	ff

- VW:** Polo, Lupo, Touareg, Porsche Cayenne.
- Opel:** Astra G, Zaphira B, Corsa C, Vectra C.
- Honda:** Jazz, CRV, FRV, Accord, Turnier.
- BMW:** 5º Modelo a partir de E 39 hasta 2005. 7º Modelo a partir de E 38 hasta 2005.
- Audi:** A3, A4, A5, A6, Audi Q7.
- Ford:** Galaxy, Alhambra.
- Mercedes:** A-Class, B-Class.



EXTRACTOR DE BRAZO LIMPIAPARABRISAS

52454 12,90€

0.20	6	36	1152
Kg	Sub	ff	ff



- Diseñado con patas finas y extremos acabados en latón para prevenir cualquier tipo de daño en la carrocería, pintura o vidrio.
- Aplicable a la mayoría de vehículos del mercado.
- Su manejo permite una extracción de forma segura del limpiaparabrisas evitando que se produzcan desperfectos en el brazo.



LLAVE DINAMOMÉTRICA CON CABEZAL INTERCAMBIABLE 200NM

52913 292,00€

- Incluyen certificado de calibración de fábrica.

1/2"

3,94 - 4 128
Kg SUB IT

- Rango de apriete: 40-200Nm.
- Cabezales incluidos: Llave plana 13, 14, 15, 17, 19, 22, 24, 27, 30mm.
- Cabezal de carraca 1/2".
- Cabezales diferentes disponibles por separado.

18x14mm

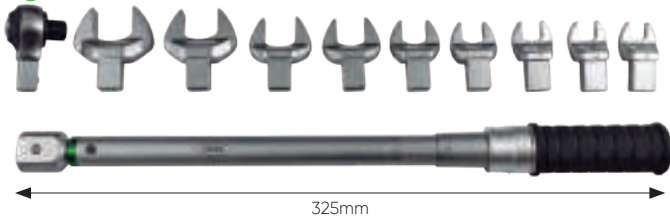

LLAVE DINAMOMÉTRICA CON MIRILLA

53081 115,00€

1.10 5 25 350
Kg SUB IT

1/4"
4-20NM (36T)
375mm



53082 148,00€

1.90 4 8 168
Kg SUB IT

1/2"
40-210NM (24T)
560mm



LLAVES DINAMOMÉTRICAS

51262 51,00€

270mm 2-24 Nm 0,2 - 2,4 M.Kg 1/4"

0,80 4 16 384
Kg SUB IT



51338 53,00€

365mm 19-110 Nm 1,9 - 11 M. Kg 3/8"

1,05 4 16 320
Kg SUB IT



51127 56,00€

470mm 28-210 Nm 2,9 - 21,4 M. Kg 1/2"

1,70 4 8 256
Kg SUB IT



- Incluyen certificado de calibración de fábrica.

53972 550,00€

8,75 - 2 42 3/4"
1000-1.210mm 200-800 Nm 21,4 - 81,6 Kg SMC/AA

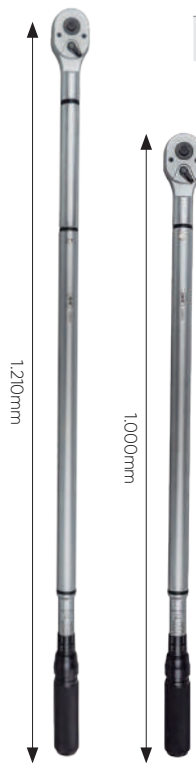

SETS DE REPARACIÓN

51262R 14,00€

0,05 20
Kg IT



51338R 14,00€

0,05 20
Kg IT



51127R 14,00€

0,15 20
Kg IT



DESTORNILLADOR DINAMOMÉTRICO MECÁNICO

51830 94,00€

- Incluyen certificado de calibración de fábrica.

1,00	-	12	300
Kg	sub	ft	mm

- Exactitud: CW: +/- 4%
- Rango de operación: 2-10 N-m
- Unidades de selección: N-m, in-lb.
- Largo (mm): 242
- Dado: 1/4"
- Vida útil: 10.000 ciclos



PROFUNDÍMETRO CON SOPORTE MAGNÉTICO

52904 61,00€

2,00	-	5	200
Kg	sub	ft	mm

- Medición: 0-10mm.
- Calibrado: 0,01mm.
- Esfera: 58mm.
- Base magnética: 40kg.



PROFUNDÍMETRO PARA REF. 52904

13704 21,00€

0,10	-	50	1500
Kg	sub	ft	mm

MULTIPLICADOR DE CARRACA 3/4" + REDUCTOR 1/2"

51958 422,00€

4,35	-	4	96
Kg	sub	ft	mm

- Características:
Relación de transmisión 1:4.
Relación de par 1:3,3.
Par máximo de entrada: 303Nm.
Par máximo de salida 1000Nm.

- Contiene:
1 Multiplicador de Par.
1 Carraca manual.
1 Adaptador 1/2" M x 3/4" F.
1 Kit liberación.
1 Barra de extensión 90°.
1 Barra de extensión 350mm.



GONIÓMETRO 1/2"

52583 8,50€

0,20	4	48	864
Kg	sub	ft	mm



GONIÓMETRO DE 1/2" IMANTADO

52794 28,00€

0,48	6	24	288
Kg	sub	ft	mm



- Útil para el apriete en grados de tornillos según especificaciones determinadas por los fabricantes de vehículos y maquinaria.
- Apriete realizado mediante carraca o llave dinamométrica de 1/2".
- Mirilla transparente para una correcta visión de la medición.
- Rango de medición de 0 a 360°.
- Fijación del goniómetro mediante brazo imantado para su correcta fijación antes de su uso. El sistema de imán permite utilizar la herramienta con rapidez y seguridad.

JUEGO DE GALGAS

52433 4,80€

0,10	10	50	1000
Kg	sub	ft	mm

0,05 - 1mm



PIE DE REY

50937 10,50€

0,24	10	50	1500
Kg	sub	ft	mm



50724 28,00€

0,30	5	50	1200
Kg	sub	ft	mm



PROFUNDÍMETRO DIGITAL

53042 9,90€

0,05	10	100	2000
Kg	sub	ft	mm

0-25,4mm



PROFUNDÍMETRO

52873 11,00€

0,04	5	300	1500
Kg	sub	ft	mm

0-40mm



MULTIPLICADOR DE FUERZA CON ALARGADOR

51919 89,00€

7,75	-	3	120
Kg	sub	if	

- Material: 40CR.
- Potencia máxima: 5800Nm.
- Potencia de trabajo: 3800Nm.
- Múltiple en rango 1:56.
- Incluye vasos de: 32mm y 33mm de 1".



MULTIPLICADOR DE FUERZA ARTICULADO

52796 98,00€

8,88	-	3	72
Kg	sub	if	

6.000Nm

- Uso en camiones con tapacubos y protector de rueda.
- Evita el daño de la llanta.
- Fácil adaptación a cualquier vehículo.
- Útil para atornillar y desatornillar sin esfuerzo.

- Incluye:
1x vaso 1" 32mm.
1x vaso 1" 33mm.

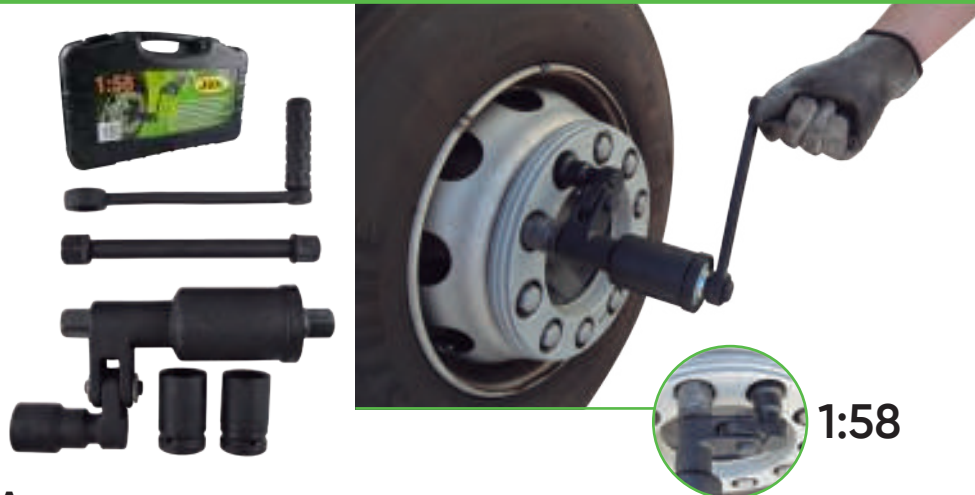

MULTIPLICADOR DE FUERZA JUNIOR

52012 68,00€

2,34	-	4	128
Kg	sub	if	

- Contiene:
1x multiplicador de par.
1x barra de extensión 90°.
Vasos de 17mm, 19mm y 21mm.



PARA TURISMOS 1/2"

- Rango 1:18.
- Par max. salida: 360Nm.
- Par max. torsión: 800Nm.



SET DE 8 VASOS 1" PARA MULTIPLICADOR DE FUERZA

52056 66,00€

5,45	-	4	128
Kg	sub	if	

22, 24, 27, 30, 32,
33, 38, 41mm

CrV 1" 8 PCS



DESPIECE DISPONIBLE

REF.	DESCRIPCIÓN	Kg	if	€
10672	32mm	0,58	1	9,50€
10673	33mm	0,58	1	9,50€
10674	27mm	0,54	1	9,50€
10675	30mm	0,54	1	9,50€

KIT CENTRADOR DE EMBRAGUE S.A.C.

53001 242,00€

905	-	1	40

- Se evitan deformaciones del embrague.
- Utilizando la Herramienta de Reseteado llevaremos a la nueva posición el anillo de reajuste de la placa de presión al montar un nuevo disco de embrague.
- Adecuado para casi todos los embragues SAC (Embrague de Ajuste Automático).

- Ventajas:
Tensado de la placa presión del embrague en el montaje y desmontaje.
Reposición muelle de ajuste con la herramienta de reseteado.

- Contenido:
Pretensor de Embrague.
Centrador de 3 agujeros.
Herramienta de reseteado.
Juego de espigas centradoras.
Centrador de 4 agujeros.

PARA:
VW
Audi
Bmw
Mercedes
Volvo
Renault
Opel



CENTRADOR DE EMBRAGUES S.A.C.

53410 92,00€

1,60	-	5	230



- Diámetro centradores:
15-19 / 20-26,6 / 23-36mm
- Diámetro accesorios:
12, 14, 15, 16, 17, 18, 19, 20mm



HERRAMIENTAS PARA CAMBIO DE EMBRAGUE DSG PARA LA TRANSMISIÓN DSG DE VAG

53057 149,00€

5,55	-	2	120

- Para servicio en cambios DSG en Golf (2004-), Golf Plus (2005-), AUDI A3 (2004-) con transmisiones de 7 velocidades código 0AM, y en Touareg (2003-) con transmisión de 6 velocidades código 08D.
- Referencias OEM de los útiles: T10323, T10373, T10374.



SET DE 10 VASOS DE 1/2" ESPECIALES PARA AUTOMOCIÓN

53669 45,00€

0,70	5	20	1080



TOYOTA, NISSAN, RENAULT,
OPEL ASTRA G/ZAFIRA, SMART, CITROËN,
PEUGEOT, HONDA CIVIC

CONTIENE

	10S	para engranaje intermedio Toyota		14 mm	para pinza de freno Opel Astra G, Opel Zafira y Smart
	6S	para embrague, culata y eje de equilibrado de Nissan y Renault		10 mm	para sistemas de freno y bomba de combustible Nissan
	8S	para embrague, culata y eje de equilibrado de Nissan y Renault		12,5 mm	para sistemas de freno y bomba de combustible Nissan
	12S	para embrague, culata y eje de equilibrado de Nissan y Renault		19 mm	para pinza de freno de Peugeot, Renault y Citroën
	8TS	para el eje de equilibrado de Nissan		20 mm	para el brazo de control interior de Honda Civic



CENTRADOR DE EMBRAGUES PLÁSTICO UNIVERSAL

52495 14,50€

0,25	4	48	384



- Para la mayoría de los modelos del mercado.
- Incluye 3 adaptadores de diferentes diámetros.



SET DE COMPROBACIÓN, LLENADO Y VACIADO DE SISTEMA AACC

53456 98,00€

BAR

2,90	-	5	75
Kg	Sub	ff	

- Permite probar las variaciones de alta y baja presión de los sistemas de aire acondicionado del vehículo.
- De peso ligero.
- Diseño de bloque de aluminio con manómetros de fácil lectura.
- Acopladores de servicio profesionales (codificados por colores y etiquetados).
- Tres mangueras de carga con código de colores y un gancho colgante para permitir el uso manos libres.
- Aplicaciones: R134a, R12.
- Longitud de la manguera: 1550mm.
- Alta presión: 0-34 BAR.
- Baja presión: 0-24 BAR.

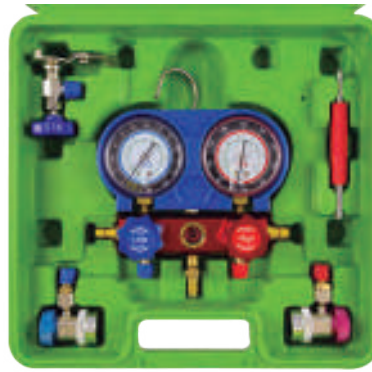

ACOPLADOR PARA ALTA PRESIÓN (REF.53456)

14300 19,00€

0.20 100

Kg ff

R-134a

ACOPLADOR PARA BAJA PRESIÓN (REF.53456)

14301 19,00€

0.20 100

Kg ff

R-134a

ADAPTADOR PARA CARGA DE GAS 1234YF

ALTA

53499 29,00€

0,30	15	60	2400
Kg	Sub	ff	

R1234YF



Adaptador de aire acondicionado / refrigerante de conexión rápida R1234YF. Rojo (alta presión). El diseño de conexión rápida permite una completa seguridad. Con conexión que protege contra lesiones y pérdida de refrigerante si se desconecta bajo presión. Uso: AACC y refrigerante

Material: latón y metal
Color: rojo, azul
Tamaño: Altura 55 mm, diámetro 30 mm.
Peso: 194g

BAJA

53500 29,00€

0,20	15	60	2400
Kg	Sub	ff	

R1234YF



ESTUCHE DE OBUSES PARA AACC

53599 30,30€

0,16	10	100	-
Kg	Sub	ff	

134
PCS



R12 5mm L: 19mm	R12 6mm L: 22mm	R134A 7mm L: 20mm
R12 5mm L: 19mm	R12 6mm L: 22mm	R12 8mm L: 22mm
R12 5mm L: 19mm	R12 6mm L: 26.5mm	R12 9mm L: 22mm



DESPIECE DISPONIBLE

REF.	MEDIDA	Kg	ff	€/u.
14594	5x19mm R12 (verde)	0,01	10	2,00€
14595	5x19mm	0,01	10	1,50€
14596	5x19mm R12	0,01	10	2,00€
14597	6x19mm	0,01	10	7,60€
14598	6x26.5mm	0,01	10	17,80€
14599	7x20mm R134A	0,01	10	4,50€
14600	6x22mm	0,01	10	9,50€
14601	8x22mm	0,01	10	11,00€
14602	9x22mm	0,01	10	11,00€

ESTUCHE DE JUNTAS TÓRICAS PARA AA/CC

50807 38,00€

0,16	6	24	672
Kg	Sub	ff	

HNBR **270**
PCS



5.29x1.78mm 20 PCS	6.07x1.78mm 20 PCS	6.8x1.9mm 20 PCS	7.65x1.78mm 20 PCS	7.80x1.90mm 20 PCS	8.0x2.0mm 20 PCS
8.80x1.90mm 20 PCS	10.82x1.78mm 15 PCS	10.77x2.62mm 15 PCS	11.0x2.0mm 15 PCS	12.0x2.0mm 15 PCS	13.9x1.80mm 10 PCS
13.95x2.62mm 10 PCS	14.0x2.0mm 10 PCS	15.0x2.0mm 10 PCS	17.0x2.00mm 10 PCS	17.17x1.78mm 10 PCS	17.04x3.53mm 10 PCS

KIT PARA LA DESCONEXIÓN DEL AIRE ACONDICIONADO

53459 66,00€

1,05	-	10	150
Kg	Sub	ff	



8mm (5/16"),
9.5mm (3/8"),
13mm (1/2"),
16mm (5/8"),
19mm (3/4"),
22mm (7/8")



9.5 mm (3/8"),
16mm (5/8"),
13mm (1/2"),
19mm (3/4")

KIT DE DETECCIÓN DE FUGAS AA/CC

53539 78,00€

1.42	-	5	150
Kg	sub	ff	ff



- Set especialmente diseñado para detectar fácilmente pérdidas de presión en el sistema de aire acondicionado y refrigeración.
- Consiste en insertar un líquido fluorescente neutro en el circuito para posteriormente detectar su fuga de forma rápida.

- Contiene:
1 x Lámpara UV 100Lm.
1 x Gafas visión UV.
1 x Jeringa inserción líquido.
1 x Adaptador rápido.
1 x Alargador adaptador.
1 x Pila recargable.
1 x Cargador.

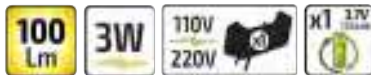

LÍQUIDO DETECCIÓN DE FUGAS SISTEMA AA/CC



12977	0.33	3	12	480
36,50€	Kg	sub	ff	ff

- Una aplicación de 7,5 ml para cada 1,4L de refrigerante.

250ml

GAFAS VISIÓN UV PARA 53539

14187	0.05	10	120	1080
6,00€	Kg	sub	ff	ff

PILA RECARGABLE PARA 53539

15052	0.05	5	10
3,00€	Kg	sub	ff

JERINGA DETECCIÓN FUGAS AA/CC REF. 52844/53539.

12200	1.10	50
14,50€	Kg	ff

LINTERNA PARA 53539

15054	0.12	5	10
34,00€	Kg	sub	ff

CARGADOR PARA 53539

15053	0.08	10
10,50€	Kg	ff

LÁMPARA PORTÁTIL COB ULTRAVIOLETA FLEXIBLE CON BASE IMANTADA

53530 46,00€

0.35	-	20	620
Kg	sub	ff	ff

380mm 45mm



LUZ ULTRAVIOLETA

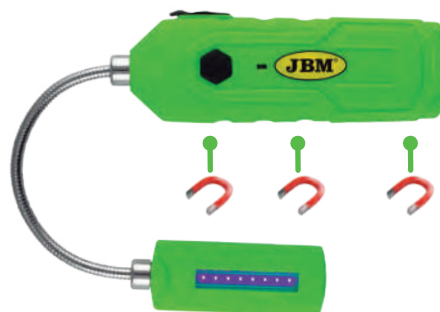

UV



COMPROBADOR DE FUGAS DE PRESIÓN PARA SISTEMA REFRIGERACIÓN

52687 168,00€

6.70	-	1	24
Kg	sub	ff	ff

- Rango de comprobación: 0-2,5 bar.
- 19 cabezales de comprobación de radiadores específicos.
- 1 cabezal de comprobación de radiadores universal.



- 1: Bomba de presión con válvula de descarga.
- 2A: conector 1: acople para los cabezales No.3(R123) y No.4 (R124).
- 2B: conector 2: acople para los cabezales No. 3 (R123) y No. 5(R125).
- 3: Mercedes (W123, W126, W124, W201), GM(Buick), Jeep
- 4: Peugeot, Subaru, Chrysler, Acura, GM (Nova, Spectrum, Sprint), Mitsubishi, Nissan, Mazda, Toyota, Infiniti, GEO, Suzuki, Isuzu, Mercedes.
- 5: Honda, Toyota, Suzuki, Mitsubishi, Chrysler, Acura.
- 6: Mercedes Benz (ML, W163, W164), GM (Achiva, Skylark, Grand Am 1992-2002).
- 7: Volvo, Saab, Sterling, Citroen, Renault, Fiat, Alfa, Jeep.
- 8: VW(Vento, T4, Passat-1996, Golf, Beetle, Sharan).
- 9: Audi(A4, A5, A6), BMW 345, VW (Pas-

- sat - 1997-2002), Porsche(Cayenne).
- 10: BMW (E46, E36, E34, E39, E38, E32, E90).
- 11: Audi, VW.
- 12: Internacional, Land Rover, Jaguar.
- 13: Mercedes (C, E, S, W140, W220, W124, W210, W211, W215, W216, W221, R230).
- 14: Ford Focus.
- 15: Mazda(M3).
- 16: Mercedes clase A (W168).
- 17: BMW E60, E63, E64, E65.
- 18: VW SHARAN 1.8T 2.8.
- 19: TOYOTA-RAV4, PREVIA Adaptador universal de goma para purga y llenado de radiadores.
- 20: SAAB.
- 21: LAND ROVER.
- 22: Kia
- 23: Hunday

SET DE LLENADO DE ACEITE CON EMBUDO Y ADAPTADORES

53485 140,00€

3,00	-	4	40
Kg	Sub	ff	ff

15
PCS

53347 100,00€

2,75	-	4	36
Kg	Sub	ff	ff

8
PCS

Contiene:

Extensiones en ángulo

- 1- Adaptador de rosca M42 x 4,5 para Subaru
- 2- Adaptador de rosca M37 x 3,0 (tipo corto) para Lotus, Pontiac, Scion, Toyota
- 3- Adaptador de rosca M35 x 4,0 para Ford, Jaguar, Land Rover Mazda
- 4- Adaptador de rosca M32 x 3,5 para Acura, Dodge, Ford, Honda, Jaguar, Jeep, Land Rover, Mazda, Nissan
- 5- Adaptador de bayoneta para Toyota y Lexus 3.0 y 3.3i V6
- 6- Adaptador de bayoneta para Audi, BMW, Mercedes-Benz, Porsche, Volvo, VW
- 7- Adaptador de rosca M30 x 3,0 para Dodge Cummins
- 8- Adaptador de rosca (1/2 vuelta) para Mazda 3 / 6 / CX-5
- 9- Adaptador de rosca (1/2 vuelta) para Cadillac, Chevy, Ford, GMC, Hyundai, Jaguar, Land Rover, Mazda, Saab, Mercury
- 10- Adaptador de rosca (1/4 de vuelta) para nuevos tapones de llenado a partir de 2088 en Audi, Seat, Skoda, VW con motor EA888
- 11- Adaptador de rosca (1/2 vuelta) para Dodge Hemi 6.4L (2011-) & >3.6L (>2014)
- 12- Adaptador de rosca M37 x 3,0 (tipo largo) para Toyota, Lexus, Scion, Pontiac



Contiene:

Extensión en ángulo

- 1- Adaptador de rosca M42 x 4,5 para Subaru
- 2- Adaptador de bayoneta M37 x 3,0 para Lotus, Pontiac, Scion, Toyota
- 3- Adaptador de rosca M35 x 4,0 para Ford, Jaguar, Land Rover, Mazda
- 4- Adaptador de rosca M32 x 3,5 para Acura, Dodge, Ford, Honda, Jaguar, Jeep, Land Rover, Mazda, Nissan
- 5- Adaptador de bayoneta para Toyota & Lexus 3.0 & 3.3i V6
- 6- Adaptador de bayoneta para Audi, BMW, Dodge, Mercedes-Benz, Porsche, Volvo, VW

BOMBA DE COMPROBACIÓN, PRESIÓN Y VACÍO PARA CIRCUITOS

54016 76,00€

1,50	-	5	100
Kg	Sub	ff	ff

Este kit incluye, junto a la bomba de vacío, un set completo de puntas, adaptadores, tapones, gomas y medidor para un correcto y fácil sangrado del sistema de frenos, así como una fácil comprobación.

Presión máxima:
40psi (3 bar)
Presión mínima:
-20 psi (-0,75 bar)



MAX
40 PSI
3 bar

MIN
-20 PSI
-0,75 bar

COMPROBADOR DE FUGAS PARA JUNTAS DE CULATA

53662 89,00€

1,78	5	10	80
Kg	Sub	ff	ff

- Esta herramienta está diseñada para comprobar las fugas entre la combustión y el sistema de refrigerado de los motores refrigerados por agua.
- El proceso de combustión produce (entre otros gases) 13-14% de CO2 en el escape, y las fugas de este gas en el sistema de refrigerado son fácilmente detectables.
- Si hay gases de combustión, el color del fluido de comprobación cambiará a color amarillo o verde y eso será prueba de la fuga de CO2 en el refrigerante.
- El fluido de comprobación NO se puede volver a usar.

Contiene:

- Botella redonda 200ml.
- Botella cuadrada 250ml.
- Adaptadores:
 - Pequeño: Toyota, Mitsubishi.
 - Mediano: Suzuki, Toyota, Mitsubishi, Subaru, Peugeot, Nissan, Lexus, Mazda.
 - Grande: Ford, GM, Benz, JEEP.



LÍQUIDO DE COMPROBACIÓN DE FUGAS EN LA COMBUSTIÓN

14563
18,00€

0,23	5	50
Kg	Sub	ff



SET DE 6 VASOS 1/2" TORX TIPO E EXTRA LARGOS

53915 65,00€

CABEZAL DE LOS VASOS EN ACABADO EN NEGRO

2.10 - 10 240
Kg SUB ff

E12 Llave de vaso para culata de BMW:
- Motor M42, 1.8L, 4 cilindros, 16V, modelo 318 is desde 1989
- Motor M50, 2.0L, 2.5L, 6 cilindros, 24V, modelo 520i, 525i desde 1991

140mm

CINCADO

1/2"
6 PCS
CrV

KIT COMPRESOR MUELLE PARA VÁLVULAS

51120 41,00€

2.10 - 5 160
Kg SUB ff

- Válido para coches y motocicletas.
- Los 5 adaptadores permiten encajar correcto y fácilmente para comprimir el muelle de la válvula.

- Contenido:
Compresor de Muelles.
Adaptadores de: 30, 25, 23, 19, 16mm.

ORGANIZADOR DE PIEZAS DE CULATA

53637 85,00€

1.40 - 5 20
Kg SUB ff

260mm 400mm 450mm

- Especial para piezas de culata.
- Mantiene todos los componentes limpios y ordenados a medida que se extraen de la culata.
- Ahorra tiempo. Te facilita el trabajo.

HERRAMIENTA NEUMÁTICA PARA ESMERILAR VÁLVULAS - PERCUSIÓN Y ROTACIÓN

53572 348,00€

1.90 - 5 80
Kg SUB ff

- Contenido:
1 x Máquina neumática para válvulas.
5 x Adaptador de válvula.
1 x 3 mm Llave Allen.
5 x Ventosa (16, 20, 30, 35 y 45 mm).

REGULA LA VELOCIDAD

16mm 20mm 30mm 35mm 40mm

50
14157 8,30€
14158 9,95€
14159 12,60€
14160 12,80€
14161 13,70€

GIRO DERECHO + GIRO IZQUIERDO

1/4" 800 RPM 1/4"
1.8 CFM 1/4"

KIT DE HERRAMIENTAS PARA AROS DE PISTÓN

53251 88,00€

2.80 - 4 72
Kg SUB ff

- Juego completo ceñidor de aros y anillos de pistón.
- Tenaza o alicata para instalar segmentos de pistones.
- El apriete de los ceñidores tiene sistema de carraca dentada.

H:3" Ø 53-125mm
H:4" Ø 60-175mm
H:6" Ø 60-175mm

COMPRESOR DE MUELLES PARA VÁLVULAS

52693 24,50€

0.65 5 20 450
Kg SUB ff

- Uso para la mayoría de motores OHV, OHC, CHV.
- Permite reemplazar muelles y sellos de válvulas con la cabeza del cilindro montada.
- Capacidad para comprimir y extraer.

- Con garra / adaptador reversible y bloqueo de posición predeterminada.

COMPRESOR MUELLE DE VÁLVULAS 45-145MM

52734 51,00€

2.61 - 5 175
Kg SUB ff

45-145mm

Ø 30mm Ø 25mm
45-145mm

SET DE 2 LAPEADORES DE VÁLVULAS

52850 7,80€

0.11 6 72 1008
Kg SUB ff

Ø 3,49-2,86mm
Ø 1,59-2,06mm

225mm
205mm

COMPRESOR AROS PISTÓN

52697 16,00€

0.50 5 40 720
Kg SUB ff

Ø 60-175mm 6"

52696 12,00€

0.28 5 40 1200
Kg SUB ff

Ø 53-175mm 3"

150mm 77mm

BRUÑIDOR DE CILINDROS

2 BRAZOS

52591 12,00€

0,10 Kg 12 SUB 72 1728

Ø 55mm
19mm

28,6mm

1-1/8"

3 BRAZOS

52592 22,00€

0,20 Kg - 20 SUB 480

Ø 85mm
35mm

50,8mm

2"

52593 34,00€

0,47 Kg 6 SUB 36 360

Ø 170mm
55mm

101,6mm

4"

PASTILLA PULIDO 1-1/8"
EN BLISTER DE 2 UNIDADES
PARA REF. 52591

11878 4,10€

0,10 Kg 25 SUB 100

PASTILLA PULIDO 2"
EN BLISTER DE 3 UNIDADES
PARA REF. 52592

11879 5,10€

0,04 Kg 25 SUB 100

PASTILLA PULIDO 4"
EN BLISTER DE 3 UNIDADES
PARA REF. 52593

11880 10,50€

0,09 Kg 25 SUB 100

COMPRESOR DE MUELLES

53394 598,00€

29,70 Kg - 1 SUB 18

- Kit profesional que permite extraer e instalar de manera rápida los muelles de suspensión delantera y trasera sin desmontar el eje.

- Brazo telescópico y superficies antideslizante que permite un agarre sólido de los muelles.
- Garras equipadas con una protección plástica intercambiable para evitar dañar la pintura del muelle
- Evita que se doblen los muelles en la compresión.
- Universal, cubre el 90% del parque de vehículos.
- Puede ser utilizado tanto para muelles rectos como cónicos.

- Contenido:
Dispositivo/pistón.
Tres pares de mordazas con fundas de plástico.

300 mm

2 x 68-123MM
2 x 68-160MM
2 x 118-212MM

36.000 Nm
1.050 Kg

Apta para utilizarse con herramientas neumáticas

KIT PARA DESMONTAR AMORTIGUADORES

53118 231,00€

6,66 Kg - 2 SUB 44

CRV 6140
CRMO
SCM415
CRV 50BV30

39 PCS



COMPRESOR DE MUELLES MANUAL

50827 387,00€

32,90 Kg - 1 SUB 15

- Capacidad: 1T (2200 lbs)
- Diámetro del muelle comprimido: 200mm
- Rango de compresión: 200-500mm

1T



COMPRESOR DE MUELLES PROFESSIONAL McPHERSON

52227 247,00€

15,10 Kg - 1 SUB 36

- Especificaciones:
Carga máxima: 2500N.
Un cuerpo principal.
Un soporte extendido.
3 pares de mandíbulas.

- Par 1: Rango de uso: 80-115mm, Peso: 1.45kg.
- Par 2: Rango de uso: 110-195mm, Peso: 2.2kg.
- Par 3: Rango de uso: 140-195mm, Peso: 2.3kg.

- BMW, Toyota, Ford, Mitsubishi, VW, Audi, Saab, Nissan, Honda Accord, Subaru, Volvo, Opel, Porsche.

KIT COMPRESOR DE MUELLE AMORTIGUADORES

51121 27,30€

1,80 Kg - 5 SUB 420

- Garra y Espárragos forjados con aleación Hierro - Carbono (termo - tratados).
- Indicada para usar en espacios limitados y bajo el arco de rueda.
- Apertura máxima: 270mm.

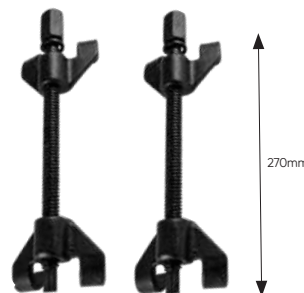

NO USAR CON PISTOLA NEUMÁTICA

PISTOLA ESTROBOSCÓPICA

DIGITAL

53474 94,00€

0,85 5 20 160

Kg SUB IT

12V 1.8m 0,1° 9.000

3,6W

- Permite ajustar el encendido en los motores.

53240 58,00€

0,75 - 20 160

Kg SUB IT

12V 1,5m

3,6W



2 PINZAS



SENSOR INDUCTIVO



2 PINZAS



SENSOR INDUCTIVO

ESTETOSCOPIO ELECTRÓNICO

53249 192,00€

2,65 - 5 40

Kg SUB IT

- Kit adecuado para detección de fallos en colectores de admisión / escape, inyectores, radiadores, etc.
- Permite la auscultación de varios puntos del vehículo de forma simultánea facilitando la tarea del operario a la hora de encontrar y diagnosticar averías.
- Sondas marcadas por color que facilitan la tarea al operario.
- Utilizado por ruido, dureza y vibración de motores para aislar las causas del problema.

- Características:
Longitud del cable del sensor: 4,8 m.
Longitud de la sonda de audio: 14 cm.
Baterías de 9V (incluida).
Cantidad de sensores: 6.
Adecuado para conector de 3,5 mm.
Longitud ajustable del micrófono: 21cm.



- Incluye:
Probadores de audio,
casco, 6 clips de micrófono
i 6 canales de micrófono
de caja.
Funciona con pilas cuadra-
das (incluidas).
Velcro de sujeción para los
sensores.

ESTETOSCOPIO

51347 9,90€

0,14 5 50 400

Kg SUB IT

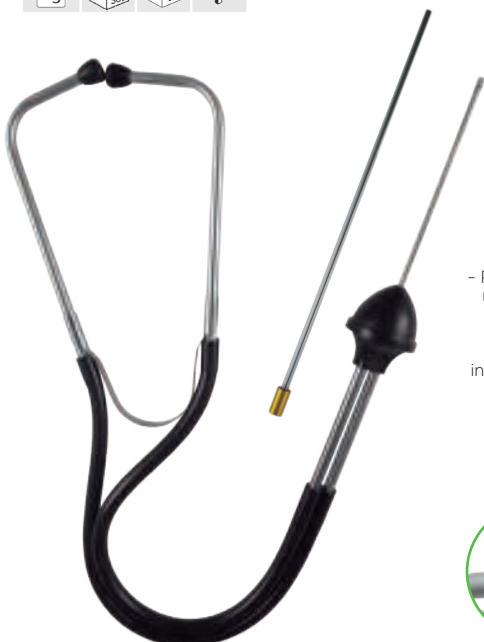

- Permite escuchar los proble-
mas de localización racional
de los flujos de agua, gas,
vapor o petróleo.
- Amplifica y localiza ruidos
internos mecánicos y de paso
de fluidos.
- Localiza la fuente de ruido
del motor rápidamente.



Ø 12mm

ÚTIL PARA EXTRACCIÓN DE CONECTORES VAG

53663 8,00€

0,01 10 100 4800

Kg SUB IT

VAG



- Herramienta para desmontar
conectores en vehículos del
grupo VAG sin dañarlos.

SET DE PUNTAS PARA AJUSTE DE FAROS

53729 19,10€

0,40	10	40	480
Kg	Sub	ff	ff



ÚTIL DE BLOQUEO PARA RESORTE DE GAS

53525 12,00€

0,10	5	30	1770
Kg	Sub	ff	ff

- Diámetro de apertura máximo: 10mm.



BARRA EXTENSIBLE MULTIFUNCIÓN

52497 26,80€

0,29	6	48	480
Kg	Sub	ff	ff

↑120mm
↓53mm

53196 33,00€

0,37	6	48	-
Kg	Sub	ff	ff

↑160mm
↓71mm

- Para comprobar el funcionamiento correcto de las luces de freno: extendiendo la barra, un extremo presionando el pedal del freno y el otro el volante.

- Para determinar la presión de los neumáticos, eliminar pequeñas piedras o clavos en las ranuras de los neumáticos, levantar el capó superior convenientemente y comprobar el aceite del motor, batería, correa, radiator, etc.

CON 3 SECCIONES DE ALUMINIO

FUERTE Y LIGERA



LLAVE PARA MANIJA DE PUERTAS VAG

53655 12,00€

0,09	12	96	1152
Kg	Sub	ff	ff



PORTAPUNTAS ANGULAR

52620 8,80€

0,05	6	36	1584
Kg	Sub	ff	ff

37mm

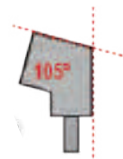

- Para zonas de difícil acceso.
- Con función de enchufe rápido.
- Fácil de extraer.
- Broca de 6mm.

JUEGO DE 8 PINZAS PARA LA DESCONEXIÓN DE MANGUERAS

53477 36,10€

0,80	-	10	220
Kg	Sub	ff	ff

8 PCS

NYLON 8, 10, 13mm

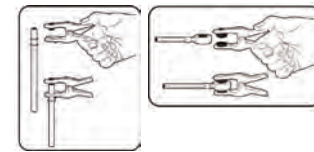

JUEGO DE TRES PINZAS PARA MANGUERAS FLEXIBLES

3 PCS NYLON

1/2" 3/4" 5/8"

52066 12,00€

0,28	5	40	480
Kg	Sub	ff	ff

- Adequado para el circuito de frenos, gasolina y refrigerante.
- Fabricadas en material ligero y aisladas eléctricamente.

- 0-20mm
- 0-35mm
- 0-70mm



53395 16,00€

0,30	5	20	360
Kg	Sub	ff	ff

Ø 13, 20, 35mm

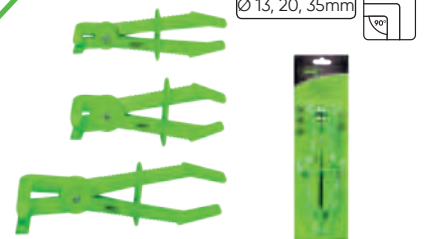

SET DE 3 BANDEJAS PARA HERRAMIENTAS FLEXIBLES ANTIDESLIZANTES

53903 59,00€

1,65	-	10	100
Kg	Sub	Paq	Paq

- Antideslizante.
- Ideal para mantener las herramientas al alcance.
- Fácil de transportar.
- Resistente al aceite.
- Soporta temperaturas de hasta 140°C
- Regla integrada a ambos lados de la bandeja.

- Compartimentos separados para mantener las herramientas bien organizadas.
- Disco de succión único para un mayor agarre en superficies planas.



- Pequeña: 285x137x27mm
- Mediana: 285x202x27mm
- Grande: 543x300x27mm
- Material: goma blanda.

BANDEJA PEQUEÑA

15010 16,50€

0,40	20	360
Kg	Paq	Paq

BANDEJA MEDIANA

15011 18,00€

0,45	20	320
Kg	Paq	Paq

BANDEJA GRANDE

15012 31,50€

1,05	10	120
Kg	Paq	Paq

BANDEJA FLEXIBLE MAGNÉTICA

- Bandeja de plástico con solapa magnética para sujetar tornillos, pernos y piezas pequeñas.

52516 28,00€

0,42	6	24	1152
Kg	Sub	Paq	Paq

- Ø superior: 225mm.
- Ø base: 88mm.
- Medidas desplegado: 135mm.
- Medidas plegado: 43mm.

52517 6,00€

0,10	12	72	1152
Kg	Sub	Paq	Paq

- Ø superior: 135mm.
- Ø base: 53mm.
- Medidas desplegado: 90mm.
- Medidas plegado: 31mm.



RECIPIENTE MAGNÉTICO

52466 11,00€

0,43	-	20	180
Kg	Sub	Paq	Paq

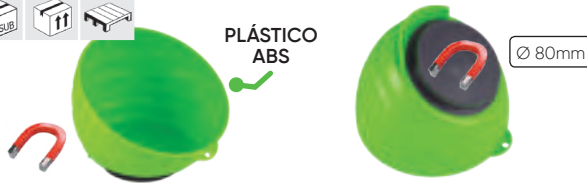

Ø 150mm

112mm

Ø 80mm

BANDEJA IMANTADA

50787 8,00€

0,35	6	36	648
Kg	Sub	Paq	Paq



x1 Ø 150mm

50788 14,50€

0,62	6	24	432
Kg	Sub	Paq	Paq



x1 239 x 139mm

COLGADOR MAGNÉTICO

52467 10,30€

0,50	-	24	1008
Kg	Sub	Paq	Paq

- Imán de gran alcance.
- Acolchado para evitar dañar superficies.

40mm 145mm 75mm



COLGADOR IMANTADO PARA HERRAMIENTA NEUMÁTICA

52378 10,00€

0,36	10	40	720
Kg	Sub	Paq	Paq

3KG Ø 60mm

51341 35,00€

1,62	-	12	96
Kg	Sub	Paq	Paq

9KG Ø 70mm



SET 2 ESTANTES IMANTADOS

50790 29,00€

1,17	-	12	96
Kg	Sub	Paq	Paq

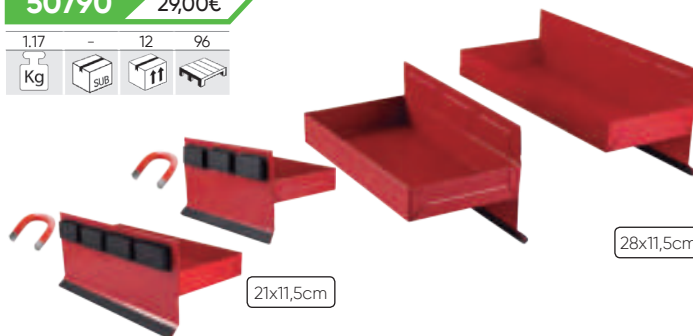

28x11,5cm

21x11,5cm

BARRA MAGNÉTICA PARA HERRAMIENTAS

50789 29,00€

0,89	10	20	500
Kg	Sub	Paq	Paq

600mm



SET DE 5 IMANES

53958 6,50€

0,05	10	100	-
Kg	Sub	Paq	Paq

Ø 15mm



NEODYMIUM RECUBIERTO 5 PCS

RECAMBIO DE GAS

51986 11,90€

0.18	-	24	1584
Kg	SUB	ff	ff

200ml



SOPLETE DE GAS

51920 18,00€

0.14	10	100	400
Kg	SUB	ff	ff

- Gas no incluido.



EXTRACTOR DE ABRAZADERAS HENN

53696 22,00€

0.10	6	96	1536
Kg	SUB	ff	ff

- Volkswagen, Audi, Seat, Škoda, BMW, Peugeot, Citroën, Dacia, Fiat, Ford, Kia, Lexus, Mazda, Mercedes, Nissan, Opel/Vauxhall, Porsche, Renault, Toyota, Volvo.

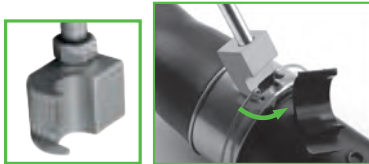

DESMONTADOR Y REMACHADOR DE CADENAS DE MOTOCICLETA

53055 33,00€

0.89	5	10	480
Kg	SUB	ff	ff



DESMONTADOR DE CADENAS DE MOTOCICLETA

53665 19,00€

0.35	10	60	1920
Kg	SUB	ff	ff



53666 28,00€

0.70	5	30	1920
Kg	SUB	ff	ff

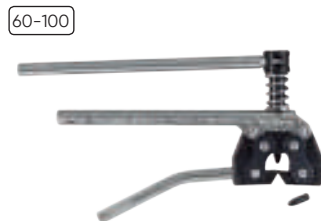

LIMPIADOR BORNES BATERIA

52319 8,80€

0.18	12	48	720
Kg	SUB	ff	ff



52621 11,00€

0.14	10	40	960
Kg	SUB	ff	ff



ESTUCHE 38 CEPILLOS METÁLICOS/PLÁSTICOS

51989 49,00€

1,64	-	10	120
Kg	sub	ff	ff



Ø 8, 9, 10, 11, 12, 13, 14, 15, 16, 17, 18, 19mm

38 PCS

- 1 Mango de 1/4".
- 1 Alargador.
- 36 cepillos.



CEPILLOS METÁLICOS

52760 4,10€

0,09	6	120	2160
Kg	sub	ff	ff



52515 9,10€

0,14	6	72	800
Kg	sub	ff	ff

- 1 x latón.
- 1 x nylon.
- 1 x acero.



225mm

3 PCS



LLAVE PARA TAPA DE AFORADORES

53096 28,80€

1,00	5	10	300
Kg	sub	ff	ff

89-170mm

15mm



EXTRACTOR UNIVERSAL DE AFORADORES

52757 16,00€

0,55	5	20	480
Kg	sub	ff	ff



160mm
75mm

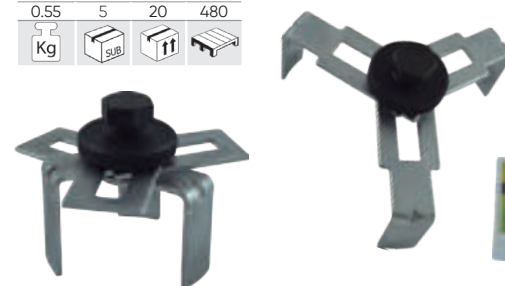

LLAVE DE VASO ESPECIAL MOTOCICLETAS

53054 6,00€

0,16	12	72	1500
Kg	sub	ff	ff

19, 22, 24mm



LLAVE PARA MOTOCICLETA

53086 9,00€

0,18	12	72	1500
Kg	sub	ff	ff

17, 19, 22, 24mm

3/8"



Yamaha, Kawasaki, BMW, Suzuki, Honda





KITS DE CALADO (TIMING TOOLS)

- | | |
|-----|--|
| 218 | BMW |
| 222 | MERCEDES |
| 224 | VAG |
| 229 | RENAULT / NISSAN |
| 231 | FORD / MAZDA |
| 233 | JAGUAR / LAND ROVER |
| 234 | OPEL / VAUXHALL |
| 238 | CITROËN / PEUGEOT / ALFA ROMEO |
| 242 | VARIOS |
| 244 | MÓDULOS Y CARROS CON
KITS DE CALADO |
| 245 | LLAVES Y EXTRACTORES |

KIT DE CALADO BMW N42 , N46 1.8 , 2.0 CADENA

53259 97,00€

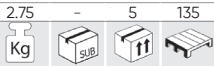

GASOLINA/PETROL

MARCAS

BMW 1 SERIES: 118i E81/82/87/88 (04-14), 120i E81/82/87/88 (04-14).
 BMW 3 SERIES: 316i/ti Compact E46 (01-07), 318i/ti Compact E46 (01-07), 318i, E90/91/92/93 (05-12), 320i E90/91/92/93 (05-12).
 BMW 5 SERIES: 520i E60/61 (07-10), Z4 2.0 E85/86 (04-09).
 BMW X SERIES: X1 sDrive 18i E84 (10-12), X1 xDrive 18i E84 (10-12), X3 2.0 E83 (05-10).

HERRAMIENTAS OEM

119350 (1), 119340 (2), 119291 (3), 119292 (4), 119270 (5), 115120 (6), 119190 (7), 119293 (8)

CÓDIGOS DE MOTOR

1.8: N42; B18A, N46; B18. / 2.0: N42; B20A, N46; B20, B20B, N46T; B20, B20B, B20BD, B20BZ, B20O2, B2O2.



KIT DE CALADO BMW N43 1.6 , 2.0 CADENA

53260 168,00€

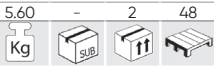

GASOLINA/PETROL

MARCAS

BMW
 BMW 1 SERIES: 116i E81/82/87/88 (07-12), 118i E81/82/87/88 (06-14), 120i E81/82/87/88 (06-14).
 BMW 3 SERIES: 316i/ti Compact E46 (01-07), 318i E90/91/92/93 (07-13), 320i E90/91/92/93 (07-14).
 BMW 5 SERIES: 520i E60/61 (07-10).

HERRAMIENTAS OEM

118690 (118691/118692/118693) (1), 118710 (118711/118712) (2), 113340 (3) (4), 118700 (5), 119340 (119341/119342) (6), 115120 (7).

CÓDIGOS DE MOTOR

1.6: N43 B16A/AA, B16AA, B16AA/OO.
 2.0: N43 B20A, B20A/AA, B20AA, B20AY, B20KO, B20UO.

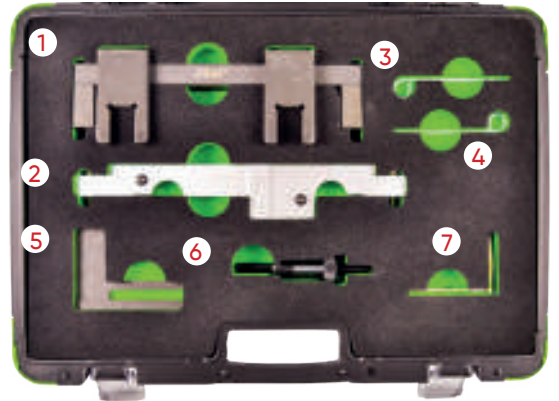

KIT DE CALADO BMW N42 , N46

53261 214,00€

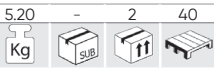

GASOLINA/PETROL

MARCAS

BMW 1 SERIES: 118i E81/82/87/88 (04-14), 120i E81/82/87/88 (04-14).
 BMW 3 SERIES: 316i/ti Compact E46 (01-07), 318i/ti Compact E46 (01-07), 318i E90/91/92/93 (05-12), 320i E90/91/92/93 (05-14).
 BMW 5 SERIES: 520i E60/61 (07-10).
 BMW X SERIES: X1 E84 sDrive 18i (10-12), X1 E84 xDrive 18i (10-12), X3 E83 2.0 (05-10).
 BMW Z SERIES: Z4 2.0 E85/86 (04-09).

HERRAMIENTAS OEM

119190 (1), 119310 (2), 119302 (3)

CÓDIGOS DE MOTOR

2.0: N42 B18A, N42 B20A, N46 B18, N46 B20, N46 B20B, N46T B20, N46T B20B, N46T B20BD, N46T B20BZ, N46T B20O2, N46T B2O2



KIT DE CALADO ÁRBOL DEL LEVAS BMW M52TU , M54 , M56 DOBLE VANOS

53262 251,00€



GASOLINA/PETROL

MARCAS

M52TUB25: 1997-2001 E46 323i/323Ci/323ti (M52T); 1998-2001 E39 523i (M52TU); 1998-2001 E36/7 Z3 (M52TU).
 M52TUB28: 1997-2001 E46 328i/328Ci (M52TU); 1997-2001 E36/7 Z3 2.8 (M52B28/Z3); 1998-2001 E39 528i (M52TU); 1998-2001 E38 728i (M52TU).
 M54B22: 2001-2003 E46 320i/320Ci; 2001-2003 E39 520i; 2001-2002 E36 Z3 2.2i; 2003-2005 E85 Z4 2.2i; 2003-2005 E60/E61 520i.
 M54B25: 2001-2002 E36/7 Z3 2.5i; 2001-2005 E46 325i/325xi; 2001-2006 E46 325Ci; 2001-2004 E46 325ti; 2001-2004 E39 525i; 2003-2004 E60/E61 525i/525xi; 2004-2006 E83 X3 2.5i; 2004-2006 E85 Z4 2.5i.
 M54B30: 2001-2005 E46 330i/330xi; 2001-2006 E46 330Ci; 2001-2003 E39 530i/2001-2002 E36 Z3 3.0i; 2003-2005 BMW E60 530i; 2003-2006 E85 Z4 3.0i; 2001-2006 E53 X5 3.0i.

HERRAMIENTAS OEM

116150 (1), 113450 (2), 113292 (3), 116180 (4), 114220(5)

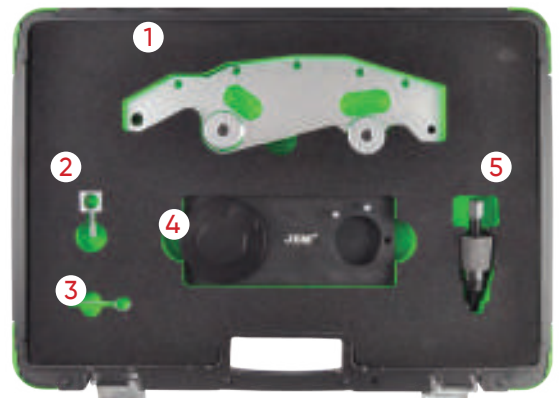

KIT BLOQUEO ARBOL DE LEVAS BMW M47

53263 57,00€

180 - 5 165

Kg SUB

DIESEL/GASOIL

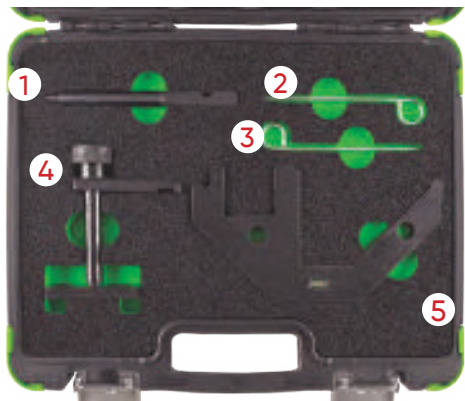

MARCAS	BMW	<p>BMW 1 SERIES: 118d E87 (04-07), 120d E87 (04-07).</p> <p>BMW 3 SERIES: 318d/td Compact E46 (01-05), 318d/td E90/91 (05-08), 320d/td Compact E46 (98-05), 320d/cd E90/91 (05-08), 325d E90/91/92/93 (02-10), 330d/cd E46/90/91/92/93 (99-07), 335d E90/91/92 (06-11).</p> <p>BMW 5 SERIES: 520d E39/60/61 (00-09), 525d/xd E39/60/61 (00-10), 530d/xd E46/60/61 (98-10), 535d E60/61 (04-10).</p> <p>BMW 6 SERIES: 635d E63/64 (07-11).</p> <p>BMW 7 SERIES: 730d/ld E38/65/66 (98-08).</p> <p>BMW X SERIES: X3 2.0d E83 (04-07), X3 3.0d/sd E83 (03-10), X5 3.0d E53/E70 (00-10), X6 3.0d E71/72 (08-10), X6 3.5d E71/72 (08-10).</p> <p>LAND ROVER: Freelander Td4 (00-06), Range Rover Td6 (02-06).</p> <p>MG/ROVER: MG-ZT/T (01-05), Rover 75 CDT/CDTi (99-05).</p> <p>VAUXHALL/OPEL: Omega-B (01-03).</p>
HERRAMIENTAS OEM	112300/12-108, 12-171/KM-813 (1), 113340/12-172/KM-823 (2) (3), 116322/12-174/KM-6267 (4) 116320 (5)	
CÓDIGOS DE MOTOR	<p>BMW</p> <p>2.0D: M47, M47T2, M47TU / 2.5D: M57, M57T2, M57TU / 3.0D: M57, M57T2, M57TU</p> <p>LAND ROVER</p> <p>2.0D: 204D3 (TD4) / 3.0D: 306D1 (TD6)</p> <p>MG/ROVER</p> <p>2.0D: M47R / 2.0d CDT: M47R</p> <p>VAUXHALL/OPEL</p> <p>2.5D: Y25DT</p>	

KIT DE CALADO PARA BMW / MINI 1.2, 1.5, 2.0, 3.0

54228 187,00€

5.15 - 2 48

Kg SUB

GASOLINA/PETROL

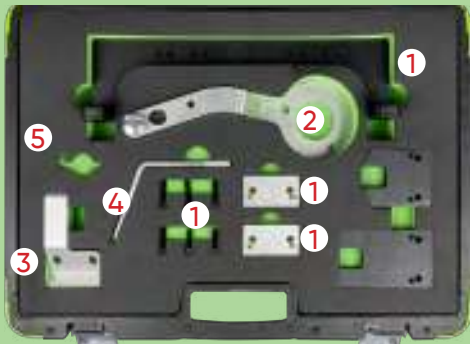

MARCAS	BMW: 1 Series (2015 - 2019), 2 Series (desde 2014), 3 Series (desde 2015), 4 Series (desde 2015), 5 Series (desde 2017), 6 Series (desde 2017), 7 Series (desde 2015), 8 Series (desde 2014), X1 (desde 2015), X2 (desde 2018), X3 (desde 2017), X4 (desde 2018) and Z4 (desde 2019); MINI: Clubman (desde 2015), Hatch (desde 2014), Convertible (desde 2016) and Countryman (desde 2017)
HERRAMIENTAS OEM	2 358 122 (1), 2 357 904 (2), 2 365 488 (3), 2 288 380 (4), 11 4 120 (5).
CÓDIGOS DE MOTOR	<p>BMW:</p> <p>1,5 B38 A15A, B38 B15A, B38 K15A ,1,6 B48 B16A, 2,0 B48 A20A, B48 A20B, B48 A20E, B48 B20A, B48 B20B , 3,0 B58 B30A, B58 B30B, B58 B30C</p> <p>Mini</p> <p>1,2 B38 A12A , 1,5 B36 A15A, B38 A15A , 2,0 B46 B20A, B48 A20A, B48 A20B</p>

KIT DE CALADO PARA MINI 1.6

54222 59,00€

1.40 5 10 240

Kg SUB

GASOLINA/PETROL



MARCAS	BMW: Mini cooper S(07-10) Peugeot: 207(06-10), 307(06-10), THP(06-10), GTI(06-10) Citroen: DS3(06-10), C4(06-10), Grande Picasso TPH(06-10)
HERRAMIENTAS OEM	119550(1), 119551(2), 119552(3), 119590(4)
CÓDIGOS DE MOTOR	N14 B16A , N14 B16CD , N14 B16TO

KIT DE CALADO BMW / DIESEL

53265 195,00€

5.45 - 2 40

Kg SUB

DIESEL/GASOIL

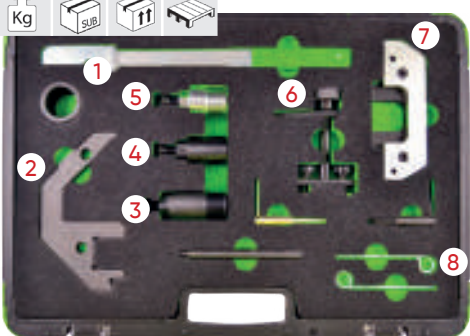

MARCAS	BMW
HERRAMIENTAS OEM	113360 (1), 116321 (2), 135190 (3), 135191 (4), 135192 (5), 116322 (6), 112300 (7), 113340 (8)
CÓDIGOS DE MOTOR	M41 / M51 / M47TU / M47TU T2. M57TU T2 3.01 1998 - 2008.

KIT DE CALADO BMW M42 , 44 , 50 , 52 , 54 , 56

53267

277,00€

GASOLINA/PETROL

8,00	-	2	40
Kg	sub	ff	

MARCAS	BMW SERIES: 3, 5, 7, X, Z
HERRAMIENTAS OEM	114220 (1), 112300 (2), 113240 (3), 115490 (4), 113292 (5), 113450 (6)
CÓDIGOS DE MOTOR	M40. M44. M50. M52. M54. M56.

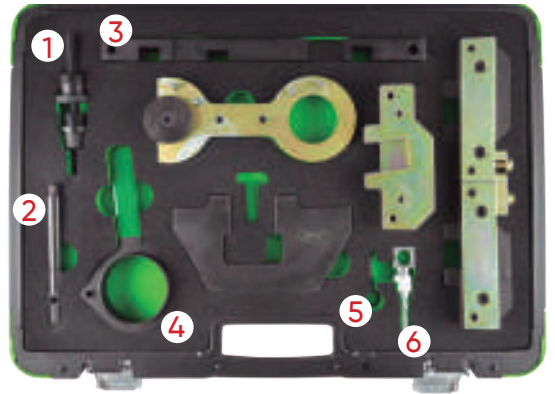

KIT DE CALADO BMW N62 , N73

53264

143,00€

GASOLINA/PETROL

4,65	-	2	40
Kg	sub	ff	

MARCAS	BMW 5 SERIES: 540i E60/61 (05-10), 545i E60/61 (03-06), 550i E60/61 (05-10). BMW 6 SERIES: 645i E63/64 (03-06), 650i E63/64 (05-11). BMW 7 SERIES: 735i E65/66 (02-05), 740i E65/66 (05-10), 745i E65/66 (02-05), 750i E65/66 (05-08), 760i E65/66 (02-08). BMW X SERIES: X5 4.4 E53 (03-07), X5 4.8 E53/E70 (04-10).
HERRAMIENTAS OEM	119463 (1), 119462 (2), 119340 (3), 119461 (4), 119190 (5)
CÓDIGOS DE MOTOR	3.6 V8: N62 B36A 4.0 V8: N62 B40A 4.4 V8: N62 B44A 4.8 V8: N62 B48B 6.0 V12: N73 B60A

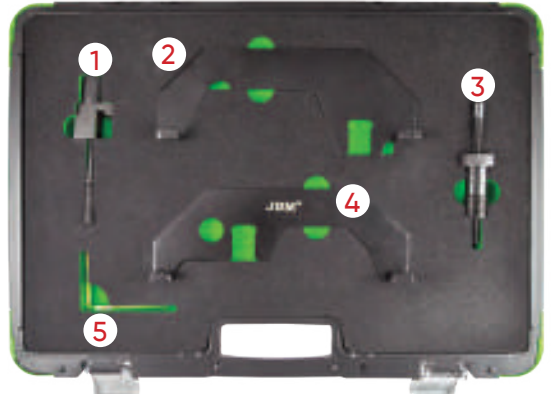

KIT DE CALADO BMW

53266

224,00€

DIESEL/GASOIL

GASOLINA/PETROL

6,30	-	2	42
Kg	sub	ff	

MARCAS	BMW
HERRAMIENTAS OEM	113240 (1), 115490 (2), 113190 (3), 112300 (4) (5), 113292 (6), 113320 (7)
CÓDIGOS DE MOTOR	GASOLINA: M42, M43, M50, M52, M60. DIESEL: M51

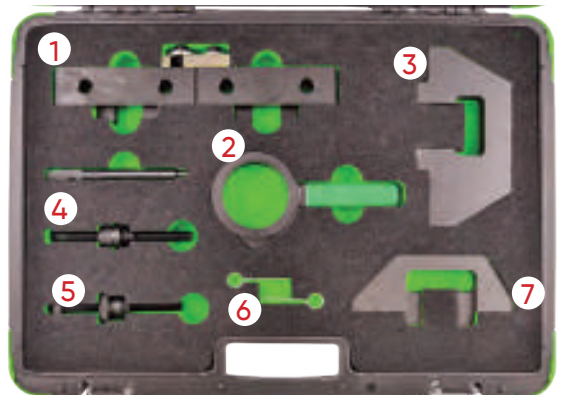

KIT DE CALADO BMW

53269

50,00€

DIESEL/GASOIL

1,25	5	10	240
Kg	sub	ff	

MARCAS	BMW
HERRAMIENTAS OEM	118760 (1), 118740 (2), 116480 (3), 115320 (4)
CÓDIGOS DE MOTOR	1.6 D: N47, C16K1, C16U1. 2.0 D: N47, C20K1, C20U1N47, D20, D20A, D20B, D20D, D20K1, D20O0, D20O1, D20T1, D20U0, D20U1, N47S D20T0, N47T, D20, D20O1, D20U1. 3.0 D: N57, B30B, B30B/T0, B30C, D30BTO, D30O0, D30O1, D30T0, D30T1, D30U0.

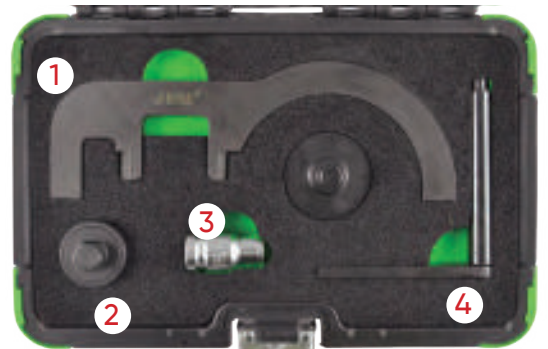

KIT DE CALADO PARA BMW / MINI 1.5 , 2.0L

54206 113,00€ **GASOIL/DIESEL**

1.75 - 5 135
Kg SUB ff



MARCAS	BMW - 1 Series - 114d, 116d, 214d - (F20/ 21) - (2015- 2017) - 2 Series - 216d, 118d, 125d - (F22/ 23/ 45/ 46) - (2014-2017) - 3 Series - 218d, 220d, 225d - (F30/31/34) - (2015-2017) - 4 Series - 316d/ 320d/ 325d - (F32, 33, 36) - (2015-2017) - 5 Series - 420d, 425d, 418d - (F10, 11) - (2014-2017) - X1 Series - 518d - (F48) - (2015-2017) - X3 Series - (F25) - (2014-2017) - Efficient Dynamics - X4 Series - (F26) - (2014-2017) - xDrive - X5 Series - (F15) - (2015-2017) - sDrive Mini - Clubman - (F54) - (2015-2017) - One D Convertible - (F57) - (2016-2017) - Cooper D/ SD Mini Hatch (F55, 56) - (2014-2017)
HERRAMIENTAS OEM	114120 (1), 2347904 (2), 2365488 (3), 2288380 (4), 118760 (5), 118740, 118030 (6)
CÓDIGOS DE MOTOR	1.5: B37 D15A, B37 C15A 2.0: B47 D20A, B47 D20B, B47 C20A, B47, B47 C20B

KIT DE CALADO BMW / MINI PSA 1.4 , 1.6

53268 92,00€ **GASOLINA/PETROL**

2.60 - 5 120
Kg SUB ff



MARCAS	BMW MINI: Mini Clubvan R55 (12-14), Mini Clubman R55 (08-14), Mini Countryman R55 (07-10), Mini Clubman R56/R57 (07-15), Mini R56/R57 (08-15), Mini Coupe R58 (11-15), Mini Roadster R59 (08-15), Mini Clubman R60 (10-14), Mini Clubvan R60 (12-14), Mini Roadster R61 (13-15), Mini Paceman R61 (14-15), Mini Countryman R60 (10-17). CITROËN: C4 (08-11), C4 Picasso (08-13) C4 Grand Picasso (13-15). PEUGEOT: 207 (06-14), 207CC (07-15), 308 (07-15), 3008 (09-15), 5008 (09-15).
HERRAMIENTAS OEM	BMW MINI: 115590 (1), 119340 (2), 119551 (3) CITROËN: 0197-A1, 0197-A3, 0197-B. PEUGEOT: 0197-A1, 0197-A3, 0197-BZ.
CÓDIGOS DE MOTOR	1.4: N12B14, N14B14AB. 1.6: EP3(8FS), EP3C(8FR), EP6(5FW), EP6C(5FS), EP6CDT(5FV), EP6DT(5FT), EP6DT(5FX), EP6DTS(5FY), N14B16A, N14B16CD, N14B16TO, N14B16CD/TO, N16B16A, N16B16KO, N16B16A/MO, N16B16A/MO, N16B16MO, N16B16UO.

KIT DE CALADO BMW/MINI N13 , N18

54227 122,00€ **GASOLINA/PETROL**

2.40 - 5 135
Kg SUB ff



MARCAS	BMW : Serie 1 (2011 - 2015), Serie 3 (2012 - 2015). MINI: Clubman (2011 - 2014), Mini (2010 - 2015), Coupe (2011 - 2015), Roadster (2012 - 2015), Countryman (2010 - 2017) and Paceman (2013 - 2017).
HERRAMIENTAS OEM	117440 (1), 119340 (2), 2299362 (3)
CÓDIGOS DE MOTOR	N12, N13, N14, N18, EP3, EP6

KIT DE CALADO BMW / MINI / CITROËN / PEUGEOT

54219 60,00€ **GASOLINA/PETROL**

1.09 - 5 135
Kg SUB ff



MARCAS	BMW, MINI, PSA
HERRAMIENTAS OEM	115140(1), 119280(2), 119330(3), 113340 (4), 114360 (5)
CÓDIGOS DE MOTOR	BMW 1.6 (N40 / N45 / N45T, B16, B16A, B16AC) 1.8 / 2.0 (N42 / N46 / N46T) 2.0 / 3.0 (N51 / N52 / N52-Componente / N53 / N54) PSA 1.4 / 1.6 16V (EP3 / EP6 / EP6DT / EP6DTS) MINI 1.4 / 1.6 (N12 / N14)

HERRAMIENTA DE EXTRACCIÓN E INSTALACIÓN DE INYECTORES DE COMBUSTIBLE PARA BMW / MERCEDES / BENZ

54220 197,00€

GASOLINA/PETROL

4,40	-	2	240
Kg	Sub	ff	

MARCAS

BMW:
135is (2008-), 335 (2007-), 335xi (2007-), 535i (2008-), 535xi (2008-), 550i GT (2010-), 750Li (2009-)
750i (2009-), X3 3.0i (2007-), X5 (2011-), X5 3.0i (2008-), X6 (2008-)
MERCEDES-BENZ:
C-class (2007-), CLK / SLK (2007-), E-class (2007-), A / CLA / GLA 45 AMG (2013-), CL / CLS 63 AMG (2010-), E / G / GL 63 AMG (2011-), GLE 63 AMG (2015-S / SL 63 AMG (2010-), SLK 55 AMG (2012-)

HERRAMIENTAS OEM

BMW: 130180(1), 130195(2), 130270(3), 130320(4), 2249115(5)
Mercedes-Benz: 271589023300(6), 278589003300(7)

CÓDIGOS DE MOTOR

BMW: N14 / N18 / N20 / N47 / N54 / N57 / N55 / N63
Mercedes-Benz: M133 / M152 / M157 / M270 / M271 / M274 / M276 / M278

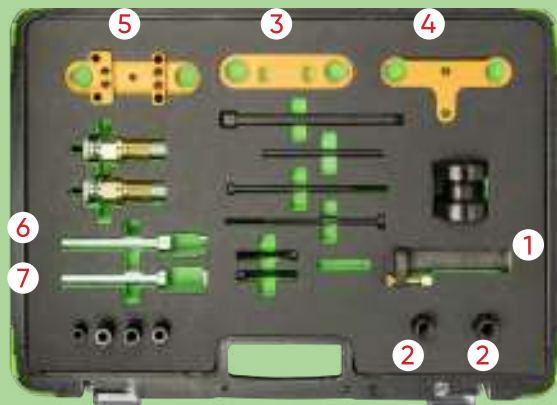

KIT DE CALADO MERCEDES M271

53271 227,00€

GASOLINA/PETROL

GASOIL/DIESEL

4,55	-	2	40
Kg	Sub	ff	

MARCAS

MERCEDES

HERRAMIENTAS OEM

271 589 003100 (1), 271589014000 (2), 271589001500 (3), 156589006100 (4)

CÓDIGOS DE MOTOR

M271, E18ML 2002, DE18ML 2003 - 2005, E16ML 2008, DE18LA 2009.

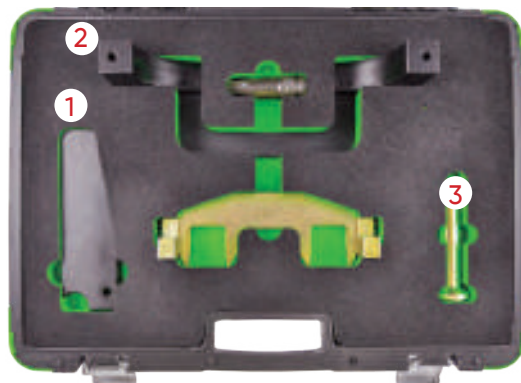

KIT DE CALADO MERCEDES AMG 156

53272 195,00€

GASOLINA/PETROL

GASOIL/DIESEL

2,10	-	5	160
Kg	Sub	ff	

MARCAS

MERCEDES

HERRAMIENTAS OEM

156589006100 (1), 156589003200 (2), 156589016300 (3), 156589006900 (4)

CÓDIGOS DE MOTOR

BENZ AMG 156, ML 63 AMG, S 63L AMG, S 63, AMG, R 63 AMG L 4MATIC, R63 AMG 4MATIC, E 63 AMG, CLS 63 AMG, CLK 63 AMG, CLK 63 AMG Black series, CLK 63 AMG Cabrio, CL 63 AMG.

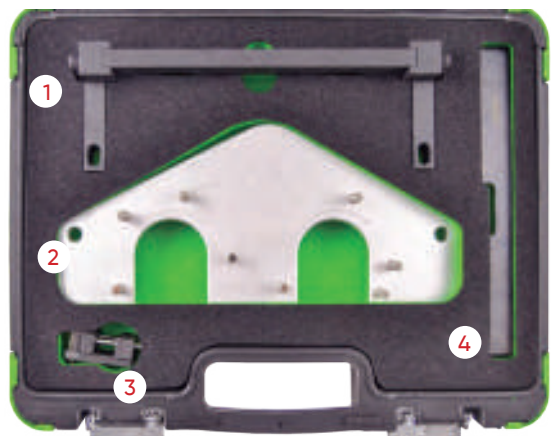

KIT DE CALADO MERCEDES / CHRYSLER / JEEP

53270 70,00€

GASOLINA/PETROL

GASOIL/DIESEL

1,40	-	10	-
Kg	Sub	ff	

MARCAS

MERCEDES
CHRYSLER
JEEP

HERRAMIENTAS OEM

112589034000 (1), 601589024000 (2), 111589031500 (3)

CÓDIGOS DE MOTOR

Herr.: 112 589 03 40 00: 112, 113, 137, 155, 156, 272/979, 273, 629, 642/992.
Herr.: 601 589 02 40 00: 102, 103, 104, 111, 601, 602.91/93/94/96/983, 603.91/93/96/97, 604, 605, 606, 611, 612/965/966, 613.
Herr.: 111 589 03 15 00: 111, 119, 604, 605, 606, 611/980, 612, 613, 628, 629, 640, 642/922, 612.965/966, 646, 647, 648.

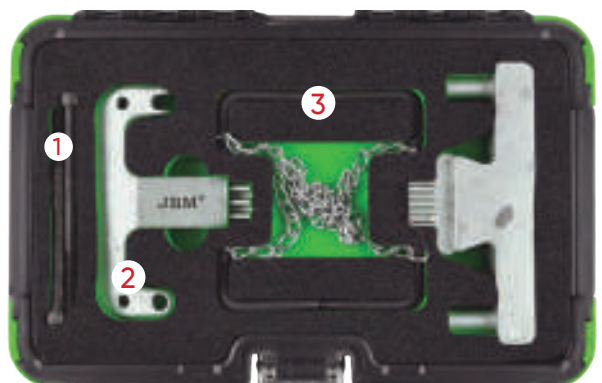

KIT DE CALADO MERCEDES M276 , M157 , M278

53273 75,00€



GASOLINA/PETROL

GASOIL/DIESEL



MARCAS	MERCEDES	
HERRAMIENTAS OEM	27658901400	
CÓDIGOS DE MOTOR	CL 500 / 63 AMG (C 216) 2010-2013. S 500 / 63 AMG (C 217) 2014. CLS 300 (C 218) 2012. E 300 / 350 / 400 (C/A 207) 2011. CLS 350 / 400 / 500 / 63 AMG (C/X 218) 2011-2014. SLK 350 (R 172) 2011. SL 350 / 400 / 500 / 63 AMG (R 231) 2012. S 500 PLUG-IN HYBRID (V 222) 2014. ML 300 / 350 / 500 / 63 AMG (W 166) 2011.	C 400 (W 205) 2014. E 400 HYBRID (W 212) 2012. G 63 AMG (W 463) 2012. E 300 / 350 / 400 / 500 / 63 AMG (W/S 212) 2011. C 350 (W/S/C 204) 2011. S 350 / 500 / 63 AMG (W/V 221) 2010. S 400 / 63 AMG (W/V 222) 2013. R 350 BlueEFFICIENCY (W/V 251) 2012. GL 450 / 500 (X 166) 2012. GLK 350 (X 204) 2011.

KIT DE CALADO CHRYSLER / JEEP LDV 2.5 CRD

54207 38,90€



GASOIL/DIESEL



MARCAS	Chrysler: Voyager (01-08), Grand Voyager (01-08) Jeep: Cherokee (01-08) LDV: Maxus (05-09)	
HERRAMIENTAS OEM	VM 9660 (1), VM1052 (2), VM1053 (3), VM1068 / VM1089 (4), VM1080 (5), VM8873 (6)	
CÓDIGOS DE MOTOR	2.5D CRD: R2516C, R2516K, R2516LVM39/40B.	2.8D CRD: R2816C5.05A, R2816K4.

KIT DE CALADO VAG 1.2 TFSI

54092 24,00€



GASOLINA/PETROL

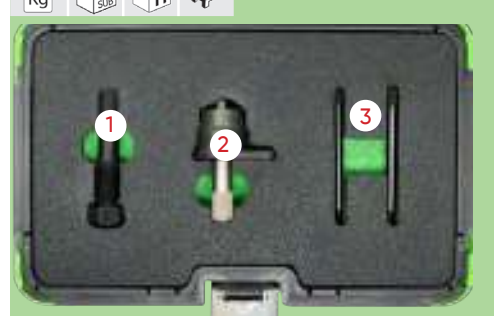

MARCAS	Audi: A1, A3, A3 Sportback, A3 Cabrio Seat: Altea, Altea XL, Ibiza, Leon, Toledo Skoda: Fabia II, Oktavia II, Praktik, Rapid, Rapid Spaceback, Rommster, Yeti VW: Beetle, Caddy, Caddy Maxi, Golf Plus, Golf VI, Golf VI Cabrio, Golf VI Estata, Jetta, Polo, Touran
HERRAMIENTAS OEM	T10340(1), T10414(2), T10341(3)
CÓDIGOS DE MOTOR	CBZA, CBZB, CBZC

SET DE HERRAMIENTAS PARA LA CORREA DE DISTRIBUCIÓN VW / AUDI

53277 45,00€



GASOLINA/PETROL

GASOIL/DIESEL



MARCAS	GASOLINA	AUDI: 80, 100, A3, A4, A6 1.6, 1.8/Turbo, 2.0, 2.0 16v, A3, A4 1.6 (96-). SEAT: Ibiza/Cordoba, Toledo, Alhambra, Inca 1.6, 1.8, 1.8 16v, 2.0, 2.0 16v/Ibiza/ Cordoba, Leon, Toledo 1.6 (99-), Alhambra 2.0 (00-). VOLKSWAGEN: Polo Classic, Scirocco, Corrado, Golf, Jetta, Vento, Passat, Sharan, Transporter 1.6, 1.8/Turbo, 1.8 16v, 2.0, 2.0 16v, Polo Classic, Golf, Bora, Beetle 1.6 (97-), 2.0 (99-). SKODA: Octavia 1.6 (97-), 2.0 (99-).
	DIESEL	AUDI: 80, 100, A3, A4, A6 1.9 Turbo D, 1.9TDi, 2.5TDi, A3, A4, A6 2.0TDi, A2, A3, A4, A6 1.2TDi, 1.4TDi, 1.9TDi (99-). SEAT: Ibiza/Cordoba, Leon, Toledo, Alhambra, Inca 1.7SDi, 1.9D/TD /Sdi/Tdi. FORD: Galaxy (02-06). SKODA: Felicia, Octavia 1.9D/Tdi. VW: Polo, Polo Classic, Golf, Jetta, Vento, Bora, Beetle, Passat, Sharan, Caddy, Transporter 1.5D, 1.6D/ Turbo, 1.7D/Sdi, 1.9Sdi/Tdi, Golf, Passat 2.0TDi.
HERRAMIENTAS OEM	T10020 (1), 3387 (2), V159 (3), T10060/T100604 (4), T10115 (5), T40011 (6)	
CÓDIGOS DE MOTOR	2.0, 2.8, 3.0	

KIT DE CALADO DE DISTRIBUCIÓN VAG 1.2 , 1.4 TSI

53648 107,00€

GASOLINA/PETROL

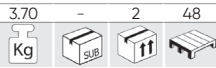

MARCAS	AUDI: A1 (12-15), A1 Sportback (12-15), A3 (13-15), A3 Sportback (12-15). SEAT: Ibiza (12-15), Leon (12-15), Toledo (12-15). SKODA: Fabia (10-13), Octavia II (10-13), Octavia III (10-15).
HERRAMIENTAS OEM	T10060A (1), T10340 (2), T10476 (3), T10494 (4), T10499 (5), T10504/1 (6), T10504 (7), T10504/2 (8).
CÓDIGOS DE MOTOR	1.2 TSi: CJZA, CJZB. 1.4 TSi: CGGA, CHPA, CMBA, CPVA, CRJA, CXSA. 1.4 TSi ACT: CPTA.

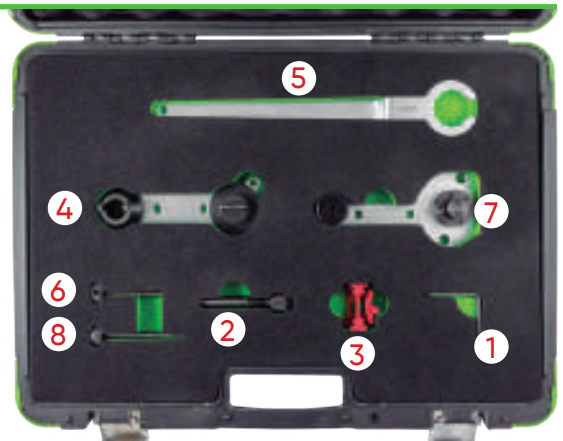

KIT ALINEACIÓN ÁRBOL DE LEVAS VAG 1.4 , 1.6 , 2.0 TDI COMMON RAIL

53706 98,00€

GASOIL/DIESEL

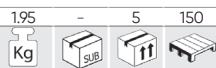

MARCAS	VOLKSWAGEN: Golf Alltrack, Golf Sportsvan, Golf VII, Golf VII Kombi, Passat, Polo. AUDI: A1, A1 Sportback, A3, A3 Cabriolet, A3 Limousine, A3 Sportback, TT, TT Roadster. SEAT: Ibiza, Ibiza V Sportcoupe, Ibiza V ST, Leon, Leon SC, Leon ST, Toledo IV. SKODA: Fabia, Fabia Kombi, Octavia, Octavia Combi, Rapid, Rapid Spaceback.
HERRAMIENTAS OEM	OEM 3204 (1), OEM 3359 (2), OEM T10490 (3), OEM T10051 (4), OEM T10060A (5), OEM T10264 (6), OEM T10265 (7), OEM T10492 (8), OEM T40098 (9).
CÓDIGOS DE MOTOR	1.4, 1.6, 2.0 TDI CR CXXB, DBKA, DCXA, CGLE, CKFB, CKFC, CLHA, CLHB, CNHA, CNHC, CRBD, CRFA, CRFC, CRKA, CRKB, CRLB, CRLC, CRMB, CRUA, CRVA, CRVC, CSUA, CSUB, CUNA, CUPA, CUSA, CUSB, CUTA, CUUD, CXEB, DBKA, DCXA, DCZA, DFSD.

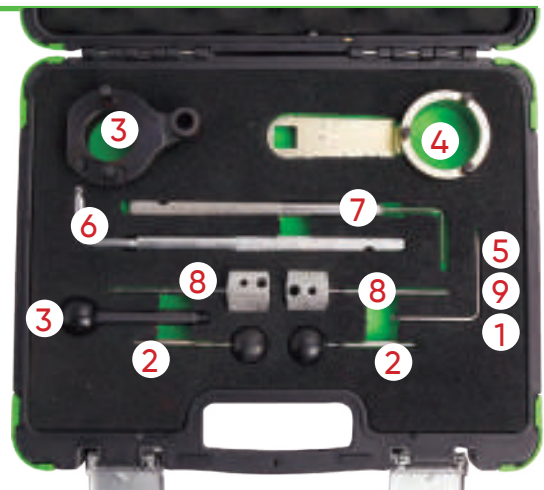

KIT DE CALADO GRUPO VAG 2.5 , 4.9D , TDI

53284 306,00€

GASOIL/DIESEL

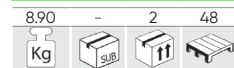

MARCAS	VOLKSWAGEN: Touareg (03-10), Transporter (03-09).
HERRAMIENTAS OEM	T10225 (1), T10199 (2), T10234 (3), T10226 (4), T10193 (5), T10194 (6), T10199/01 (7), T10226 (8).
CÓDIGOS DE MOTOR	2.5D TDi PD: AXD, AXE, BAC, BLJ, BLK, BNZ, BPC, BPD, BPE.

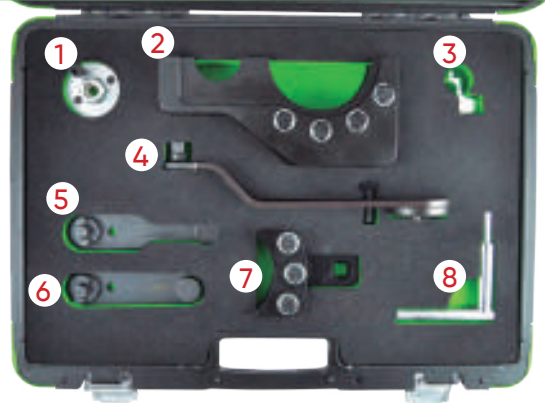

KIT DE CALADO AUDI V6 2.0 , 2.8 , 3.0 TFSI

53278 143,00€

GASOLINA/PETROL



MARCAS	A2, A4, A4 Quattro, A6 (2004-2007) A2, A3, A4, A3 FSI (2004-2007) A4, A6, A8 3.2 FSI A6 L Quattro 2.4 A6 2.4, A6 2.4 Quattro (2004-2007) A4 3.2 FSI (2004-2007) A6 3.2 FSI (2004-2007) A8 3.2 FSI (2005-2007)
HERRAMIENTAS OEM	T10172 (1), 3212 (2), T40070 (3), T40069 (4), T40071 (5), T10172/2 (6)
CÓDIGOS DE MOTOR	AUK / BDW / BDY / BKH / CAJA / CALA

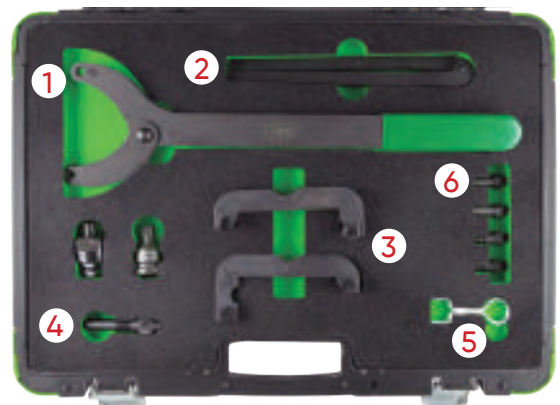

KIT DE CALADO AUDI / SKODA

53276

160,00€



GASOLINA/PETROL

GASOIL/DIESEL

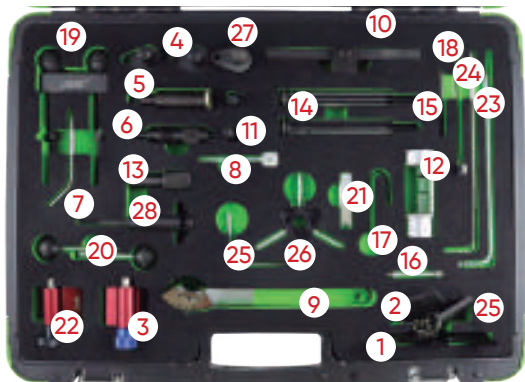

MARCAS

MOTORES AUDI_VW: V6 2.0, 2.8, 3.0T FSI.
AUDI Q5: 2.0, A6L 2.8, 3.0T.

HERRAMIENTAS OEM

3418 (1), 3458 (2), T10100 (3), T10123 (4), T10121 (5), 3242 (6), 3551 (8), T10020 (9), T10098 (10), 3078 (12), 2064 (13), 3369 (14), T10092 (15), T40011 (17), 2065A (18), T10016 (19), 3359 (20), T10008(21), T10050 (22) T10265 (23), T10264 (24), T10060A (25), T10120 (27), 3366 (28)

CÓDIGOS DE MOTOR

2.0, 2.8, 3.0

KIT ALINEACIÓN ÁRBOL DE LEVAS VW / AUDI

53281

55,00€



GASOIL/DIESEL



MARCAS

VOLKSWAGEN: 2.5 TDi V6 DIESEL
AUDI: A4, A6, A8

HERRAMIENTAS OEM

3369 (1), 3242 (2), 3458 (3)

CÓDIGOS DE MOTOR

AFB/AKN

KIT DE CALADO VW / AUDI

53282

48,00€



GASOLINA/PETROL



MARCAS

SEAT: Alhambra (10-15), Altea/Altea XL (08-15), Ibiza/ Cordoba (08-12), Leon (07-13), Toledo (07-15).
VOLKSWAGEN: Beetle (11-15), Caddy/Caddy Maxi (10-15), EOS (06-12), Golf (03-12), Golf Plus (03-14), Golf V Estate (07-13), Golf VI Cabriolet (10-15), Jetta (06-14), Passat (05-11), Polo (02-14), Scirocco (08-12), Tiguan (07-12), Touran (03-15).
SKODA: Fabia II (07-15), Octavia II (04-15), Praktik (10-15), Rapid (12-15), Roomster (06-15), Superb II (09-14), Yeti (09-14).
AUDI: A1 (10-15), A3 (03-13).

HERRAMIENTAS OEM

T10171 (1), T10170 (2), T40011 (3)

CÓDIGOS DE MOTOR

1.2 TFSI: CBZA, CBZB, CBZC.
1.4 FSI: AXU, BKG, BLN.
1.4 TFSI: BLG, BMY, BWK, CAVA, CAVB, CAVC, CAVD, CAVE, CAVF, CAXA, CAXC, CDGA, CSMA.
1.6 FSI: BAG, BLF, BLP, BTS.

KIT DE CALADO VOLKSWAGEN / SEAT / SKODA 1.2L

53274

30,50€



GASOLINA/PETROL

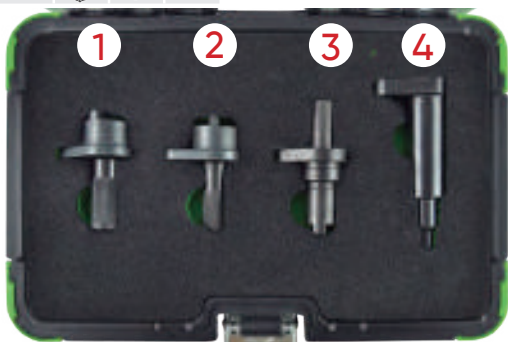

MARCAS

VOLKSWAGEN
1.2: Lupo / Polo / Eos / Fox.
SEAT
1.2: Ibiza / Cordoba
SKODA
1.2: Fabia

HERRAMIENTAS OEM

T10123 (1) (2), T10120 (3), T10121 (4)

CÓDIGOS DE MOTOR

AWY / BMD / AZQ / BME.

KIT DE CALADO VW / AUDI 2.0 TFSI

53279 97,00€



GASOLINA/PETROL

MARCAS

AUDI: A3 (96-09), A4 (94-09), A6 (95-11), S3 (99-13), TT (98-14).
SEAT: Alhambra (97-10), Altea/Altea XL (06-09), Cordoba (99-02), Exeo (09-10), Ibiza (99-02), Leon (99-13), Toledo (99-09).
SKODA: Octavia/Octavia Tour (98-10), Octavia II (04-09).
VOLKSWAGEN: Beetle (99-11), Bora (97-04), Eos (06-10), Golf (97-12), Golf Plus (05-09), Jetta (05-09), Passat (96-10), Scirocco (09-14), Sharan (97-10), Touran (03-09).

HERRAMIENTAS OEM

T10020 (1), T10252 (2), T10092 (3), T10115 (4), T40011 (4), 3366 (5), T10060 (6)

CÓDIGOS DE MOTOR

1.8: ADR, AFY, AGN, AJP, APG, APT, AQE, ARG, ARH, AVV.
1.8T: AEB, AGU, AJH, AJL, AJQ, AMK, AMU, ANB, APP, APU, APX, APY, AQA, AQX, ARX, ARY, ARZ, AUM, AUG, AVC, AWC, AWT, AWU, AYP, BAM, BFV, BVP, BVR.
2.0 FSI: AXW, BHD, BLR, BLX, BLY, BMB, BVX, BZY, BVZ.
2.0 TFSI/S/R/Tsi: AXX, BPY, BWA, BGB, BPG, BPJ, BUL, BWE, BWT, BYK, BHZ, BZC, BWJ, BYD, CDLA, CDLB, CDLC, CDLD, CDLF, CDMA.

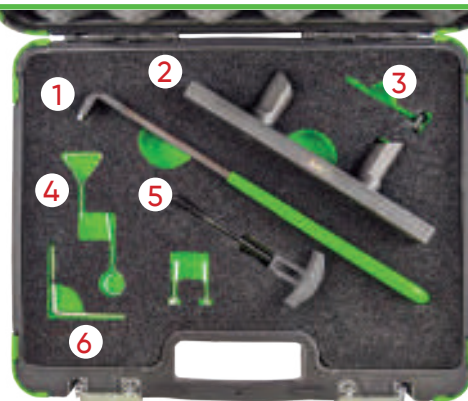

KIT DE CALADO PARA VAG TFSI , FSI

54199 94,00€



GASOLINA/PETROL

MARCAS

Audi: A1 (10-15), A1 Sportback (10-15), A3 Cabriolet (10-13), A3 (10-15), A3 Sportback (03-13).
Seat: Altea/Altea XL (10-15), Ibiza (10-15), Leon (10-13), Toledo (12-15).
Skoda: Fabia II (10-15), Praktik (10-15), Rapid (12-15), Rapid Sportback (12-15), Octavia II (04-13), Yeti (09-15), Yeti Outdoor (13-15).
VW: Beetle (11-15), Caddy/Caddy Maxi (10-15), EOS (07-15), Golf V (03-13), Golf V Estate (07-09), Golf VI (10-13), Golf VI Estate (10-13), Golf VI Cabriolet (11-15), Golf Plus (05-14), Jetta (05-14), Passat (05-15), Polo (09-14), Scirocco (08-14), Tiguan (07-15), Touran (03-15).

HERRAMIENTAS OEM

T10414(1), VAS 6079(2), T10170(3), T10171/ T10171A(4), T40011(5), T10340(6), T10341 (7)

CÓDIGOS DE MOTOR

1.2 TFSI: CBZA, CBZB, CBZC
1.4 FSI/TFSI: BLG, BMY, BWK, CAVA, CAVB, CAVC, CAVD, CAVE, CAVF, CAXA, CAXC, CDGA, CSMA
1.6 FSI: BAG, BLF, BLP

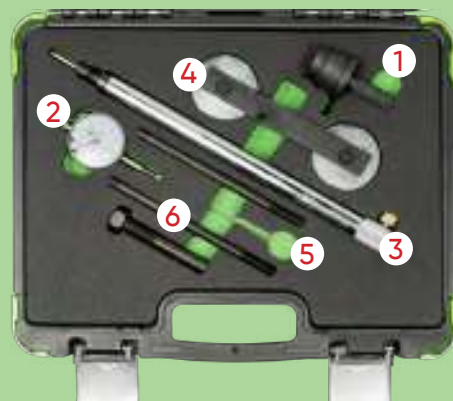

KIT ALINEACIÓN ÁRBOL DE LEVAS VW / AUDI

53280 112,00€

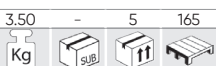

GASOLINA/PETROL

MARCAS

AUDI: A4 (01-08), A6 (01-08), A8 (03-10).

HERRAMIENTAS OEM

3387 (1), T40030 (2) (4), T40026 (3), T40028 (5)

CÓDIGOS DE MOTOR

3.0 V6 30v: ASN, AVK, BBJ, BGN.

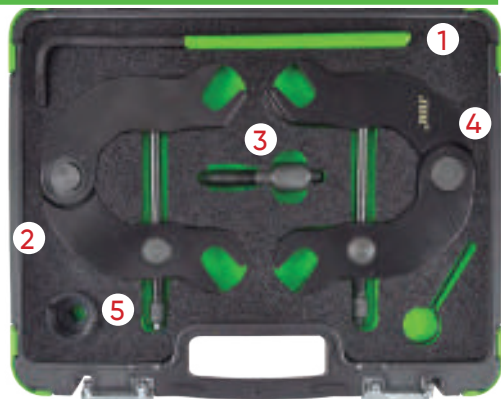

KIT DE CALADO VW / AUDI

53326 16,00€

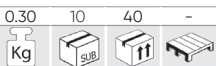

GASOIL/DIESEL



MARCAS

VW: V6 2.5TDi.
AUDI: V6 2.5TDi, V8 3.3TDi.

HERRAMIENTAS OEM

3458 (1), 3242 (2)

KIT DE CALADO VW 1.2

53327 11,00€

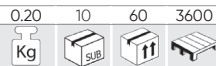

GASOLINA/PETROL



MARCAS

SEAT: Ibiza 1.2 6v/3cyl (2002-09), Cordoba 1.2 12v/3cyl (2002-13).
VW: Polo 1.2 6v-12v/3cyl (2002-14).
SKODA: Fabia 1.2 6v-12v/3cyl (2002, 2003-), Fabia II 1.2 6v/3cyl (2007-13), Roomster 1.2 12v/3cyl (2006-13), Praktik 1.2 6v/3cyl (2007-13).

HERRAMIENTAS OEM

T10123.

CÓDIGOS DE MOTOR

1.2 6v: AWY, BMD, BBM, CHFA, CHFB
1.2 12v: AZQ, BME, BVX, BZG, CEVA, CGPA, CGPB, CGPC.

KIT DE CALADO GRUPO VAG 2.7 , 3.0 TDI

53283 92,00€

GASOIL/DIESEL

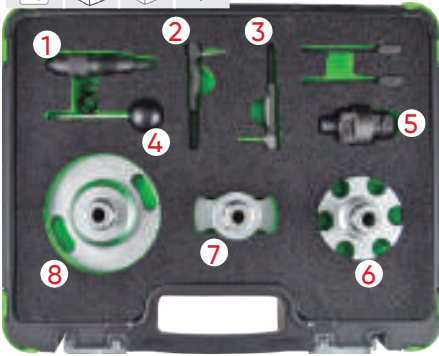
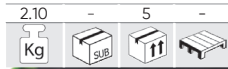

MARCAS	VOLKSWAGEN: Touareg, Phateon VAG: Diesel 2.7 / 3.0 V6 AUDI: A4, A5, A6
HERRAMIENTAS OEM	3242 (1), T40060 (2) (3), 3359 (4), T40058 (5), T40061 (6), T40062 (7), T40049 (8)
CÓDIGOS DE MOTOR	ASB, BKN, BKS, BWZ, BNG, BPP, BSG, BUG, BUN, CAWA, CAMB, CANA, CANB, CANC, CAND, CAPA, CARA, CARB, CASA, CASE, CASC, CAM, CC/HA, CCWA, CCWB, CDYA, CDVB, CDVC, CEXA, CGKA, CGKB.

KIT DE CALADO GRUPO VAG 2.4 , 2.5D SDI

53285 56,00€

GASOLINA/PETROL



MARCAS	VOLKSWAGEN: Crafter (06-13), LT (96-06), Transporter (90-03).
HERRAMIENTAS OEM	2065A (1), T50009 (2), T10025 (3), 3248/3419 (4), 2064 (5), 3355 (6)
CÓDIGOS DE MOTOR	2.4D: AAB, AJA. 2.5D SDI: AGX. 2.5D Tdi: ACV, AHD, AHY, AJT, ANJ, APA, AUF, AVR, AXG, AXL, AYC, AYY, BBE, BBF. 2.5D TDiCR: BJJ, BJK, BJL, BJM.

KIT DE CALADO GRUPO VAG 1.8 , 2.0 TSI

53286 87,00€

GASOLINA/PETROL

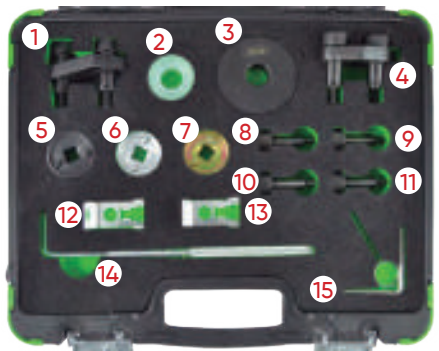
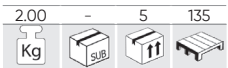

MARCAS	VOLKSWAGEN: 1.8 / 2.0 TSI / TFSI.
HERRAMIENTAS OEM	T10368 (2), T10354 (3), T40271 (1)(4), T10352/2 (5), T10352/1 (6), T10352 (7), T40196 (8) (9) (10) (11), T40267(12) (13), T40098 (14), T10060A (15), T40011 (15)
CÓDIGOS DE MOTOR	BYT, BZB, CABA, CABB, CABD, CADA, CAEA, CAEB, CAWA, CAWB, CBFA, CCTA, CCZA, CCZB, CCZC, CDA, CDAB, CDHA, CDHB, CDNB, CDNC, CDND, CESA, CETA, CFKA, CGYA, CJEB, CJBA, CJSB.

KIT DE CALADO VW/AUDI 1.8 , 2.0L TURBO

53287 245,00€

GASOLINA/PETROL

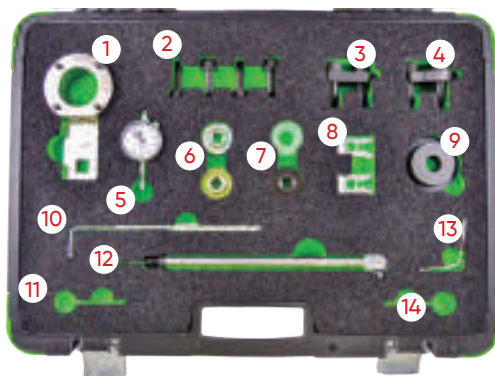
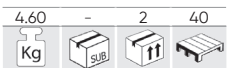

MARCAS	VOLKSWAGEN AUDI	1.8 / 2.0 TURBO
HERRAMIENTAS OEM	T10355 (1), T40196 (2), T40271 (3) (4), T10352 (5), T10352/1 (6), T10352/2 (7), T10368 (7), T40267 (8), T10354 (9), T40265 (10), T40011 (11) (14), T40098 (12), T10060A (13)	
CÓDIGOS DE MOTOR	BYT, BZB, CABB, CABD, CADA, CAEA, CAEB, CAWA, CAWB, CBFA, CCTA, CCZA, CCZB, CCZC, CDA, CDAB, CDHB, CDNB, CDNC, CDND, CESA, CETA, CFKA, CGYA, CJEB, CJSB, CJSB.	

KIT DE CALADO GRUPO VAG

53275 35,50€

GASOIL/DIESEL

0,70	5	10	330
Kg	Sub	Box	Tray

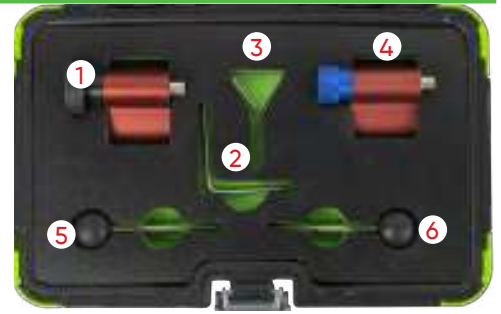

MARCAS

DODGE: Caliber (06-11)
 FORD: Galaxy (02-06)
 MITSUBISHI: Grandis (05-10), Lancer (05-10), Outlander (07-10).
 SEAT: Alhambra (00-15), Altea/Altea XL (04-15), Cordoba (02-09), Ibiza (02-15), Leon (00-13), Toledo (04-11).
 SKODA: Fabia (00-14), Fabia II (07-15), Octavia (00-10), Octavia II (04-15), Praktik (10-15), Rapid (11-15), Roomster (07-15), Superb (02-08), Superb II (08-15), Yeti (09-14).
 AUDI: A1 (10-15), A2 (00-06), A3 (01-13), A4/Allroad (01-16), A5 (08-15), A6 (11-14), TT (08-14), Q3 (11-15), Q5 (08-15), A6 (10-14).
 VOLKSWAGEN: Amarok (10-16), Beetle (02-15), Bora (02-08), Caddy/Maxi (03-15), EOS (06-15), Fox (05-11), Golf (02-15), Golf Plus (05-14), Jetta (05-15), Lupo (02-05), Passat/CC (02-15), Polo (99-14), Scirocco (08-14), Sharan (02-15), Tiguan (07-15), Touran (03-15), Transporter (03-17).

HERRAMIENTAS OEM

DODGE: 9882, 9883.
 FORD: 310-085/23-059, 303-1054.
 MITSUBISHI: MB995206, MB995208, MB995209.
 VAG: T10100 (4), T10050 (1), 3359 (3/6)/T20102, T10115 (3), T10060A (2)/T40098, T20167.

CÓDIGOS DE MOTOR

1.2D TDI CR: CFWA.
 1.4D TDI PD: AMF, BAY, BMS, BNM, BNV, BWB.
 1.6D TDI CR: CAYA, CAYB, CAYC, CAYD, CAYE, CLNA.
 1.9D TDI PD: AJM, ANU, ARL, ASZ, ATD, AUY, AVB, AVF, AVQ, AWX, AXB, AXC, AXR, BJB, BKC, BLS, BLT, BMT, BPZ, BRM, BRR, BRJ, BRU, BSU, BSV, BSW, BTB, BVK, BXE, BXF, BXJ.
 2.0D TDI CR/TDI PD: AZV, BDJ, BDK, BEW, BGW, BHW, BKD, BKP, BKQ, BLB, BMA, BMM, BMN, BMP, BMR, BNA, BPW, BRA, BRC, BRD, BRE, BRF, BRT, BSS, BST, BSY, BUY, BUZ, BVA, BVE, BVF, BVG, BVH, BWC, BWV, CAAA, CAAB, CAAC, CAAD, CAEE, CAGA, CAGB, CAGC, CAHA, CAHB, CBAA, CBAB, CBAC, CBBA, CBBB, CBDA, CBDB, CBDC, CBEA, CCHA, CCHB, CDBA, CDCA, CEGA, CFCA, CFFA, CFFB, CFFD, CFFE, CFGB, CFGC, CFHA, CFHB, CFHC, CFHD, CFHE, CFHF, CFJA, CGLA, CGLB, CGLC, CGLD, CJAA, CJCA, CJCB, CJCC, CLCA, CLCB, CLJA, CLLA, CNEA, ECD, ECD/BSY, ECD/BYL, ECE/BWD.

KIT DE CALADO AUDI / VW / SEAT / SKODA

53649 89,00€

GASOLINA/PETROL

3,48	-	2	48
Kg	Sub	Box	Tray

MARCAS

AUDI
 SEAT
 SKODA
 VW

HERRAMIENTAS OEM

T10340 (1), T10476 (2), T10477 (3), T10487 (4), T10494 (5), T10499 (6)

CÓDIGOS DE MOTOR

1.0 MPI: CHYA.
 1.0 TSI: CHZE, CHZC, CHZA, CHZB, CHZC, CHZD, CHZJ.
 1.2 TSI: CJZB, CJZC, CYVA, CJZA, CJZD, CYVB.
 1.4 TSI: CZCC, CMBA, CZCA, CHPA, CPTA (ACT), CZDA, CVNA, CZEA (ACT).

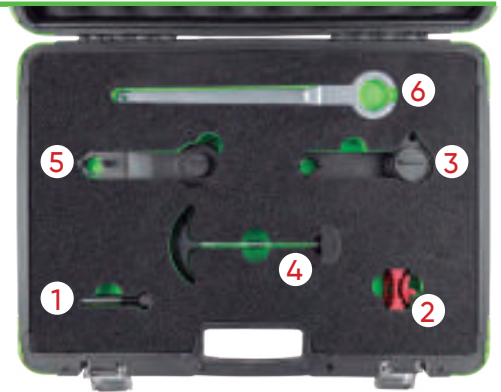

KIT DE CALADO GRUPO VAG 1.6 , 2.0 TDI CR

53288 72,00€

GASOIL/DIESEL

2,05	-	5	135
Kg	Sub	Box	Tray

MARCAS

SEAT: Exeo, Leon, Altea, Toledo, Ibiza.
 VOLKSWAGEN: Jetta, Touran, Golf, Golf Plus, Polo, Passat, Tiguan, Scirocco.
 SKODA: Roomster, Fabia, Praktik, Octavia, Yeti, Superb.
 AUDI: A1, A3, A4, A5, Q5, A6, TT.

HERRAMIENTAS OEM

T10264 (1), T10265 (2), T20102 (3), T10052 (4), T10051 (5), T10255 (6), T10050 (7), T10100 (8), T40098 (9)

CÓDIGOS DE MOTOR

1.2 TDI CR, 1.6 D TDI CR, 2.0 D TDI CR

CAGA, CAGB, CAGC, CAHA, CAHB, CFHC, CBAA, CBAB, CFFB, CGLA, CGLB, CJCA, CJCB, CAAA, CBAA, CBAB, CBAC, CBBA, CBBB, CBDA, CBDB, CBDC, CCHA, CEGA, CJAA, CAAB, CAAC, CFJA, CFWA, CAYB, CAYC, CAYA.



KIT DE HERRAMIENTAS PARA AMORTIGUADOR DE VIBRACIONES GRUPO VAG

54218 142,00€

GASOLINA/PETROL

1,95	-	5	135
Kg	Sub	Box	Tray

MARCAS

AUDI, SEAT, SKODA, VOLKSWAGEN

HERRAMIENTAS OEM

T10531/1 (1), T10531/2 (2), T10531/3 (3), T10531/4 (4)

CÓDIGOS DE MOTOR

1.8L TFSI:
 BZB, CDAA, BPU, BYT, CABA, CABB, CDHA, CDHB, CABD, DAJB, CJSA, CJSB, CJEB, CJEE, CJED, CYGA, CDAC, CJSC, CGYA, DAJA
 2.0L TFSI:
 CAWB, CCZA, CBFA, CCTA, CDNB, CDNC, CDND, CJXA, CJXE, CJXH, CHHB, CHHA, CULA, CFKA, DEDA, CHJA, CAWA, CCZC, CCZD, CPSA, CJKA, CJKB, CESA, CETA, CFPA, CNCD, CPLA, CYRB, CYRC, CNCE, CYNB, CYP A, CULB, CULC, CNCB, CWZA, CJXF, CJXC, CJXB, CJXG, CHHC, CCZB



KIT DE CALADO RENAULT 1.4 , 1.6 , 1.8 , 2.0 16V

53289

45,00€

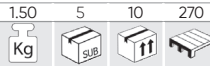

GASOLINA/PETROL

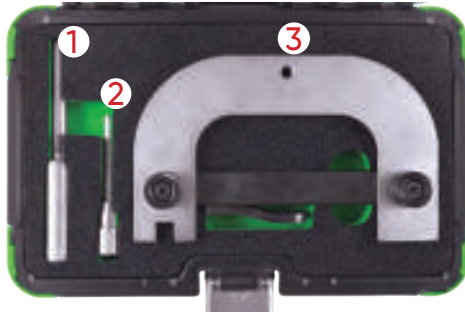

MARCAS

RENAULT: Espace/Grand Espace (98-02), Espace/Grand Espace IV (02-10), Kangoo/Trekka (01-09), Laguna (98-01), Laguna II (01-07), Laguna III (07-13), Megane (99-03), Megane II (02-10), Megane III/Sport (08-13), Megane/Scenic (99-00), Scenic/RX4 (99-03), Scenic/Grand Scenic II (03-09), Trafic II (01-11), Twingo II (08-14), Vel Satis (00-10), Wind (10-14)
 DACIA: Logan/MCV (05-11).
 NISSAN: Kubistar X76 (03-09), Primastar (02-11).
 VAUXHALL/OPEL: Jetta, Touran, Golf, Golf Plus, Polo, Passat, Tiguan, Scirocco.

HERRAMIENTAS OEM

Mot1489 (1), Mot1054 (2), Mot1496 (3)

CÓDIGOS DE MOTOR

1.4 16v K4J: 730, 732, 740.
 1.6 16v K4M: 752, 753, 760, 761, 764, 788, 812, 813, 854, 856.
 1.8 16v F4P: 720, 722, 760, 770, 771, 772, 773, 774, 775.
 2.0 16v F4R: 700, 701, 712, 713, 714, 715, 720, 722, 730, 732, 736, 738, 740, 741, 744, 746, 747, 762, 763, 764, 765, 766, 767, 770, 771, 780, 790, 791, 792, 820, 830, 832, 867.
 2.0 16v F4R(i): 720, 722, 764, 765, 774, 776, 784, 786, 787, 794, 795, 796, 797, 800, 802, 810, 811, 870, 872, 874, 886, 887, 896, 897.

KIT DE CALADO RENAULT

53291

68,00€

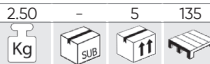

GASOLINA/PETROL

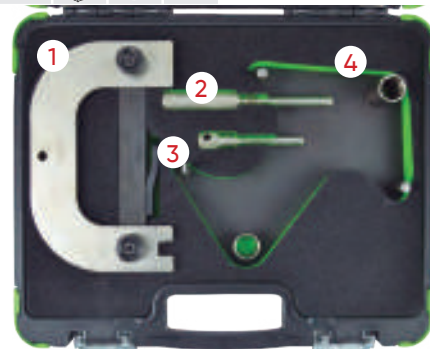

MARCAS

RENAULT: Clio, Laguna, Megane

HERRAMIENTAS OEM

MOT1496 (1), MOT1489 (2), MOT861/1863 (3), MOT1490(4)

CÓDIGOS DE MOTOR

K4J, K4M, F4P, F4R.

KIT DE CALADO RENAULT / VOLVO 16V , 20V

53290

51,00€

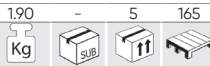

GASOLINA/PETROL

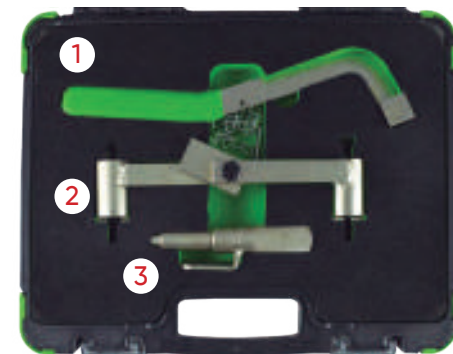

MARCAS

RENAULT: Laguna 2.0 16V / 2.5 20V (1996-1999), Safrane 2.0 16V / 2.5 20V (1996-2001)
 VOLVO: 850 (1992-1997), C70 (1998-2002), S40 (1996-2004), V40 (1996-2004), S60 (2001-2005), S70 (1997-2000), S80 (1999-2005).

HERRAMIENTAS OEM

MOT1348 (1), MOT1337 (2), MOT1340 (3)

CÓDIGOS DE MOTOR

RENAULT: N7Q 704/710/711(2.0 16V),N7U 700/701(2.5 20V).
 VOLVO: B4164S, B4164S2, B4184S, B4184S2, B4184S3, B4184S9, B4184S10, B4194T, BS194T2, B420S4, B4204S2, B4204T, B4204T2, B4204T3, B4204T5, B5202Fs, B5204FT, B5204T2, B5204T3, B5204T4, B5204T5, B5234FS, B5204FT, B5234T3, B5234T4, B5234T5, B5234T6, B5234T7, B5234T8, B5234T9, B5244S, B5244S2, B5244SG, B5244SG2, B5244T, B5244T3, B5244T4, B5244T5, B5244T7.

KIT DE CALADO RENAULT / NISSAN 1.6dCi

53523

91,00€



GASOIL/DIESEL



MARCAS

RENAULT: Espace/Grand Espace IV (06-10), Kaleos (08-11), Laguna II (05-07), Laguna III (07-12), Master III (10-12), Magane II (06-10), Scenic/Grand Scenic II (06-09), Scenic/Grand Scenic III (09-12), Trafic II (06-12), Vel Satis (05-10)
 NISSAN: Primastar X83 (06-10), Qashqai/Qashqai+2 J10 (07-10), X-Trail T31 (07-12).
 VAUXHALL / OPEL: Movano-B (10-12), Vivaro (06-12).

HERRAMIENTAS OEM

MOT1969 (1), MOT1970 (2), MOT1770, MOT1773, EN-48330, EN-48332, EN-48334, EN-48831, KM-6130

CÓDIGOS DE MOTOR

M9R 2.0dCi: 610, 615, 630, 700, 721, 740, 742, 760, 761, 762, 763, 780, 782, 784, 786, 788, 800, 802, 803, 805, 808, 816, 830, 832, 833.
 M9T 2.3dCi: 670, 672, 676, 678, 680, 686, 690, 692, 694, 698.

KIT DE BLOQUEO DEL VOLANTE/ POLEA DEL CIGÜEÑAL PARA **RENAULT/ NISSAN**

54225 133,00€

GASOLINA/PETROL



MARCAS	Nissan: Primastar (06-15), Qashqai/Qashqai+2 (07-14), X-Trail (07-14), Navara (15-16), NV400 (11-16) Renault: Espace V (15-16), Clio (06-16), Fluence (09-15), Laguna (05-15), Latitude (10-15), Megane (06-15), Scenic/Grand Scenic (06-15), Espace/Grand Espace IV (02-15), Koleos (08-16), Trafic II (07-15), Vel Satis (00-10), Master III (10-16)
HERRAMIENTAS OEM	MOT 1431(1), MOT 1716(2), MOT 2019(2), MOT 1789(3), MOT 919-02(4)
CÓDIGOS DE MOTOR	1.4: H4JT700 1.6: M5M400, M5M450 2.0: M4R700, M4R701, M4R704, M4R711, M4R713, M4R714, 2.0D: M9R726, M9R730, M9R735, M4R737, M9R740, M4R746, M9R742, M9R744, M9R746, M9R748, M4R750, M4R751, M4R752, M4R753, M4R754, M9R610, M9R613, M95615, M9R630, M9R750, M9R760, M9R761, M9R762, M9R762, M9R763, M9R700, M9R721, M9R722, M9R724, M9R756, M9R780, M9R782, M9R800, M9R802, M9R803, M9R804, M9R805, M9R806, M9R808, M9R809, M9R811, M9R812, M9R814, M9R815, M9R816, M9R817, M9R820, M9R824, M9R828, M9R830, M9R832, M9R833, M9R834, M9R835, M9R836, M9R838, M9R839, M9R844, M9R845, M9R846, M9R849, M9R854, M9R855, M9R856, M9R857, M9R858, M9R859, M9R865, M9R866, M9R784, M9R786, M9R788 2.3D: M9T670, M9T672, M9T676, M9T678, M9T680, M9T686, M9T690, M9T692, M9T694, M9T696, M9T698, M9T700, M9T702, M9T706, M9T708, M9T870, M9T880, M9T890, M9T896, M9T898, M9T906, YS23DDT, YS23DDTT 2.5: 2TR700, 2TR702, 2TR703, 2TR704, 2TR705, 2ZV604, V4U604, VQ25 3.5: V4Y701, V4Y711, V4Y713, V4Y715



KIT DE CALADO **RENAULT / NISSAN / OPEL / VOLVO**

53769 178,00€

GASOLINA/PETROL

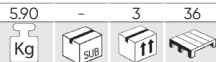

GASOIL/DIESEL

MARCAS	RENAULT: Avantime, Clio, Espace, Kangoo, Laguna, Master, Megane, Modus, Scenic, Twingo, Trafic. OPEL/VAUXHALL: Movano, Vivaro. DACIA: Dokker, Duster, Logan, Sandero. NISSAN: Almera, Interstar, Kubistar, Micra, Note, Primera, Qashqai. VOLVO: S40, V40
HERRAMIENTAS OEM	MOT 1312 (1), MOT 1135-01 (2), MOT 1384 (3), MOT 1340 (4), MOT 1543 / KM-6234 / KV113 B0360 (5), MOT 1489 / KV113 B0130 (6), MOT 1536 / KM-6203 (7), MOT 1489 (8), MOT 1054 / KM-6031 / KV113 / B0280 (10), MOT 1318 (11), MOT 910 (12), MOT 910 (14), MOT 1386 (15), MOT 1534 / KM-6205 (16), MOT 1543 / KM-6234 / KV113 B0360 (17), MOT 1543 / KM-6234 / KV113 B0360 (18), MOT 1543 / KM-6234 / KV113 B0360 (19), MOT 1543 / KM-6234 / KV113 B0360 (20), MOT 1386 (22), MOT 1537 / KM-6204 (23), MOT 1348 (24), MOT 1538 (25), MOT 1337 (26), MOT 1496 / MOT 1750 (27), MOT 1490-01 (28), MOT 1200-01 (29)
CÓDIGOS DE MOTOR	GASOLINA: 2.0 16V, 2.5 20V, 1.4, 1.6 16V, 1.8, 2.0 16V, 1.2, 1.7, 1.8, 2.0 16V, 2.2 DIESEL: 1.9, 2.5, 2.8 D4F702/706/708/712/714/716/722/728/730/740/764, D7F700/701/710/720/722/726/730/744/746/764/766, E7F700/704/706/750, E7J601/624/626/634/635/680/700/706/710/711/716/718/719/720/724/726/728/740/742/745/754/756/757/764/770/771/773/780, F3P670/682/700/704/706/708/710/712/714/720/724/755/758/760, F7P704/722, F3R611/722/723/728/729/750/751/752/791/796/797/798, F5R700/701/740, J7R732/733/734/735/768, F7R710/714, J7T600/760/761/762/766/772/780/782, N7Q704/710/711, N7U700/701, K4J700/710/711/712/713/714/715/730/732/740/750/770/780, K4M700/701/704/706/707/708/709/710/711/712/714/716/718/720/724/730/732/734/736/740/742/743/744/745/746/748/750/752/753/754/760/761/762/764/765/766/768/776/782/788/790/791/794/800/801/802/804/812/813/830, K9K700/702/704/706/710/712/714/716/718/722/724/728/729/732/734/740/750/752/760/762/764/766/768/802/804/806, F9Q610/650/664/670/674/711/716/717/718/720/722/730/731/732/733/734/736/738/740/744/748/750/752/754/758/759/760/768/762/770/772/774/780/782/784/786/788/790/796/800/803/804/808/812/816/818/820, G9T600/605/700/702/703/706/707/710/712/720/722/742/743/750, G9U720/724/726/730/750/754, F8M736/760, F8Q600/610/606/620/622/624/630/632/640/644/646/648/662/672/678/680/682/684/692/696/706/714/720/722/730/732/740/742/744/764/768/706/776/784/786/788, J8S620/621/622/758/760/776/778, G8T714/716/740/752/760/790/792/794, S8U720/722/730/731/742/748/750/752/770/772/780/782, S9U700/702/704/714/740, S9W700/702/206/208/212, E5F, E6J, K7M, F4P/F4R, FIN, F2N, F3N, F2R, F3P, F4P, F3R, J5T, J6R, J7R

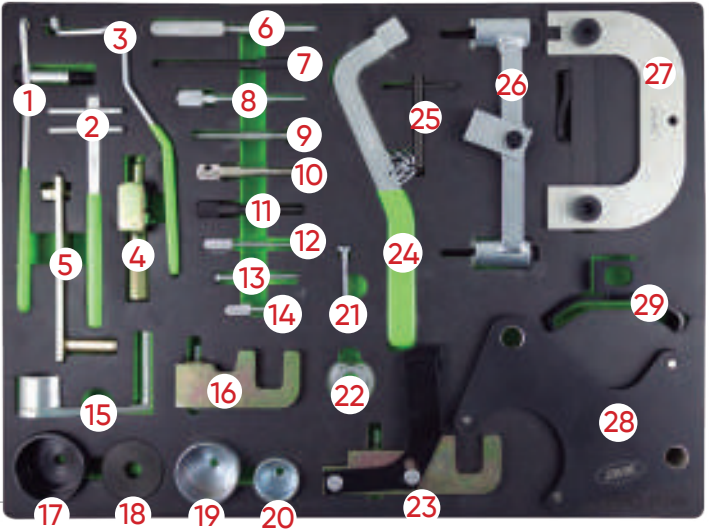

KIT DE CALADO **RENAULT / OPEL 2.2 , 2.5 TDI DCI**

53292 116,00€

GASOLINA/PETROL



MARCAS	RENAULT: Laguna II, Espace, Master, Trafic, 2.2 / 2.5 DCI OPEL: Vivaro, Movano, DIESEL: 2.2 / 2.5 DTI, Astra B, Vectra B, Signum, Zafira, 2.2 16V
HERRAMIENTAS OEM	KM6205 (1), KM6204 (2), KM6077 (3)
CÓDIGOS DE MOTOR	2.2 / 2.5

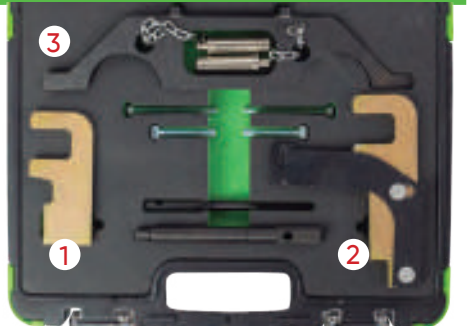

HERRAMIENTA DE BLOQUEO DE ÁRBOL DE LEVAS PARA **RENAULT 1.8, 2.0 16V**

54210 84,00€

GASOLINA/PETROL



MARCAS	Renault: Laguna II (2001 - 2009), Megane II (2002 - 2009), Scenic (2002 - 2009)
HERRAMIENTAS OEM	MOT 1509-01 (1), 1509 (2)
CÓDIGOS DE MOTOR	700, 701, 712, 713, 714, 715, 720, 721, 722, 722, 730, 732, 736, 738, 740, 741, 744, 746, 747, 760, 761, 762, 763, 764, 765, 766, 767, 770, 771, 773, 774, 774, 775, 776, 784, 786, 787, 790, 792, 794, 797, 830, F4P, F4R



KIT DE CALADO FORD

53293 134,00€

GASOLINA/PETROL

GASOIL/DIESEL

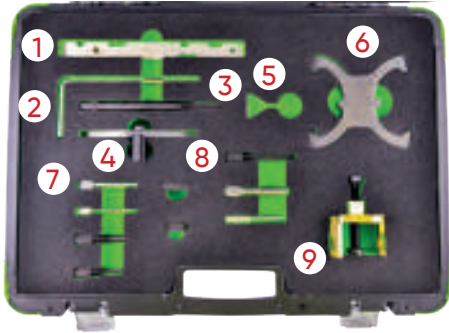
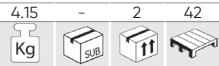

MARCAS	FORD	B-Max (12-17), C-Max (07-17), Cougar (98-01), Courier (00-02), Escort (94-98), Fiesta (95-17), Focus (98-17), Focus C-Max (03-07), Fusion (02-12), Galaxy (06-15), Grand C-Max (10-17), Kuga (08-15), Maverick (01-07), Mondeo (93-15), Orion (94-94), Puma (97-02), S-Max (06-15), Tourneo Connect (02-15), Transit (06-11), Transit Connect (02-16), EcoSport (13-15), Tourneo Courier (14-15), Grand Tourneo Courier (13-15).
HERRAMIENTAS OEM	303-376 (21-162B) (1), 303-1059 (2), 303-193 (21-104) (3), 303-393-01 (4), 303-1054 (5), 303-1097 (6), 303-748 (7), 303-734 (21-262) (8), 303-651 (21-229) (9), 303-393A (21-168) / 303-393-02 / 303-507 (21-210) / 303-620 (21-163) / 303-732 (21-260) / 303-735 (21-263).	
CÓDIGOS DE MOTOR	GASOLINA: AODA/B, ASDA, ASDB, CFBA, CGBA/B, CHBA/B, CJBA/B, CSDA/B, DHA, DHB, DHC, DHD, DHE, DHF, DHG, EDBB, EDBD, EDDB, EDDC, EDDD, EDDF, EYDB, EYDC, EYDD, EYDE, EYDF, EYDG, EYDI, EYDJ, EYPA, EYPC, F8JA, F8JB, FHA, FHD, FHE, FHF, FUJA, FUJB, FXDA/C, FXDB/D, FXJA, FXJB, FYDA/C, FYDB/D, FYJA, FYJB, HWDA, HWDB, LIF, LIJ, LIL, LIN, LIQ, LIT, LIV, LIW, M7JA, M7JB, MHA, MHB, NGA, NGB, NGC, NGD, QQDA/B/C, QQDB, RKA, RKB, RKF, RKH, RKJ, RKK, HXDA. DIÉSEL: F6JA, F6JB, F6JC, HHJA, HHJB, G8DA, HHDA, HHDB, RTN, RTQ, RTP, C9DC, BHDA/B, BHPA, C9DA/B, F9DA/B, FFBA, FFDA, HCPA, HCPB, KKDA, P7PA, P9PA, QYWA, R2PA, R3PA, RWPA, G6DA, G6DB, G6DC, AZWA, QXWA.	

HERRAMIENTA DE BLOQUEO DE ÁRBOL DE LEVAS PARA FORD 1.5T

54223 149,00€

GASOIL/DIESEL

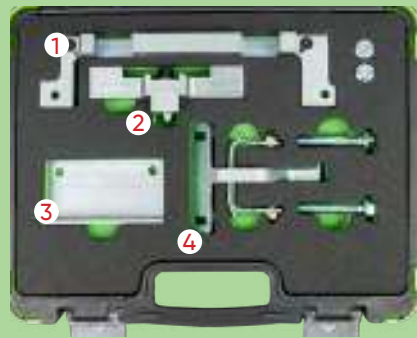

MARCAS	FORD, 1.5L Duratec, EcoSport, Fiesta, Focus
HERRAMIENTAS OEM	303-1639(1), 303-1643(2), 303-1647(3), 303-1648(4)
CÓDIGOS DE MOTOR	2.2 / 2.5

MULTIPLICADOR DE FUERZA 5:1 PARA MOTORES FORD ECOBOOST

54260 277,00€

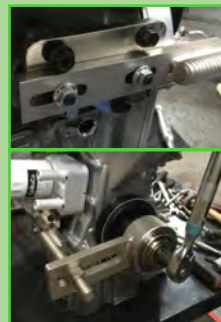

1.0 EcoBoost 2.0 Durator-TDCi
1.0 Duratec 2.0 EcoBlue Diesel
2.0 Duratec

KIT DE CALADO FORD

53653 207,00€

GASOLINA/PETROL

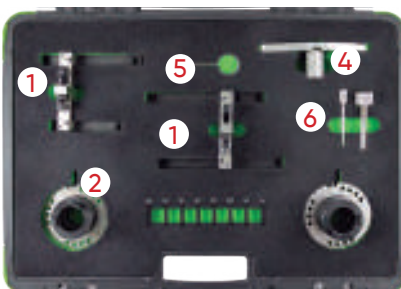
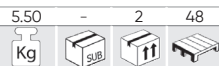

MARCAS	FORD: Fiesta, Focus, B-MAX, EcoSport.
HERRAMIENTAS OEM	303-1605 (1), 303-1606 (2), 303-1604 (3), 303-1602 / 503-393A / (21-168) (4), 303-1054 (5), 303-732 (6)
CÓDIGOS DE MOTOR	M1DD, M1JA, M1JC, M1JE, M1JHM1JJ, M1DA, M2DA, M2DB, M2DC, SFDBSFJA, SFJB, SFJC, SFJD

KIT DE CALADO FIAT / FORD / OPEL / SUZUKI 1.3L

54211 74,00€

GASOIL/DIESEL



MARCAS	Fiat: Punto (2003-2007) / Panda (2003-2009) / Idea (2004-2006) / Doblo (2004-2006). Ford: KA. Vauxhall / Opel: Agila (2003-2008) / Corsa C (2003-2007) / Corsa D (2006-2009) / Combo C (2003-2009) / Astra H (2004-2009) Tigra B (2004-2009) / Meriva (2004-2009). Suzuki: Ignis (2003-2009) / Wagon R (2003-2009) / Swift (2003-2010).
HERRAMIENTAS OEM	1871000200/303-1469/KM-662-C (1), EN 46785/KM 955/09912-38300 (2), 1871000900/1860985000/303-1472/EN 46781/09917-68610(3), 1870900400 (4), 1870900300 / 303-1468 (5)
CÓDIGOS DE MOTOR	Fiat: 1.3 JTD 188A9.000 / 169A.000 / 188A8.000 / 199A3.000. Ford: 1.3 TDCi. Vauxhall / Opel: 1.3 CDTi Z13DT / Z13DTH / Z13DTJ. Suzuki: 1.3 CDTi Z13DT.

KIT DE EXTRACCIÓN E INSTALACIÓN DE BOMBA DE INYECCIÓN PARA FORD 2.0

54224 64,50€

GASOIL/DIESEL

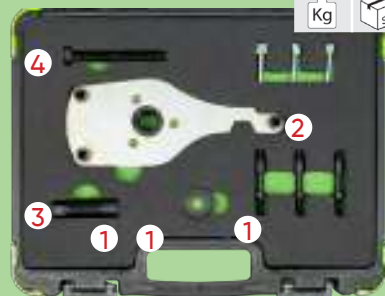

MARCAS	FORD: Transit (17-18), Tourneo Custom (16-18), Transit Custom (16-18)
HERRAMIENTAS OEM	303-1635(1)/3, 3.3--1635(2)/1, 303-1635(3)/2, 303-1635/6(4)
CÓDIGOS DE MOTOR	YLFS, YMFS, YNFS, YLF6, YMF6, YNF6, YLR6, YMR6 and YNRS.

KIT DE CALADO FORD 2.0 ECOBLUE

54204 124,00€

2,55 - 5 135
Kg SUB

GASOIL/DIESEL

MARCAS

Ford Edge, Focus, Galaxy, S-MAX (from 2018); Kuga, Mondeo, Ranger (desde 2019); Transit, Transit Custom and Tourneo Custom (desde 2016); todos con motor EcoBlue TDCi ; AWD, FWD y RWD.

HERRAMIENTAS OEM

303-1637(1), 303-1650(2), 303-1643(3).

CÓDIGOS DE MOTOR

BCCC,YLCB,YLDA,YLF6,YLFA,YLFB,YLFS,YLR6,YLRA,YM-CB,YMF6,YMFA,YMFB,YMFS,YMHA,YMRA,YNCA,YNF6,YNFA,YNFB,YNFS,YNR6,YNRA



KIT DE CALADO FORD

54201 37,60€

1,05 5 10 240
Kg SUB

GASOLINA/PETROL

MARCAS

Ford: C-MAX(07 - 10), C-MAX/Grand C-MAX(10-18), Fiesta(08-18), Focus/Focus C-MAX(04-11), Focus(11-18), Mondeo(07-15)

HERRAMIENTAS OEM

303-1097 (1), OEM 303-1054 (2), OEM 303-1059, 303-1270, 0188X, 999-7121 (3), OEM 303-748, 999-7152, 21-259 (4), OEM 303-735, 999 7122, 0187B, 0189B, 0132AJ1, 21-263, 0188M, MOT 1430, 303-1277, 0194B (5)

CÓDIGOS DE MOTOR

11,6 TI-VCT HXDA (2003-2007), 2.0 TDCI , G6DA, G6DB, G6DC 2003-2007



KIT DE CALADO FORD/MAZDA 2.2 , 3.2 TDCI

54209 29,70€

0,85 5 10 240
Kg SUB

GASOIL/DIESEL

MARCAS

Ford_Ranger 3.2L (2011-2016)
Ford_Ranger 2.2L (2011-2015)
Ford_Transit 2.2L (2006-2016)
Ford_Everest 3.2L (2015)
Ford_Ranger 3.2L (2011)

Mazda BT-50 (2011)
Mazda BT-50 3.2L (2011-2016)

HERRAMIENTAS OEM

303-675/21-234,303-698/21-251 (1), 303-1587(2)

CÓDIGOS DE MOTOR

CYFA,CYFB,DRFA,DRFB,P8FA,P8FB,PGFA,PGFB,QVFA,QWFA,SRFA,SRFB,SRFC,SRFD,SEFE,UHFA,CYFC,DRFC,USRA

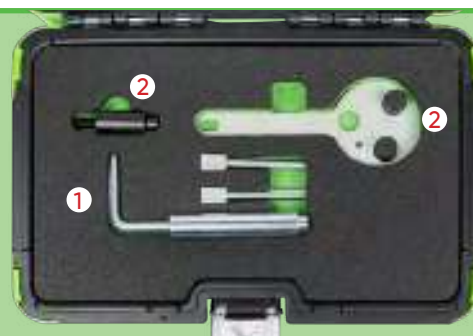

KIT DE CALADO FORD 2.0 ECO BOOST SCTI , TI-VCT

54208 76,00€

1,95 - 5 135
Kg SUB

GASOLINA/PETROL

MARCAS

FORD: Galaxy(2010) Mondeo (2010) S Max (2010) Focus(2011)

HERRAMIENTAS OEM

303-748 (1), 303-1504 (2), 303-1565 (3), 303-1521 (4)

CÓDIGOS DE MOTOR

TNWA, TNWB, TPWA, TNBA, TPBA, MGDA, XQDA



KIT DE CALADO FORD 1.8TDDI / TDCI

53295 77,00€

GASOIL/DIESEL

2,10 - 5 165
Kg SUB

MARCAS

C-Max (07-10), Courier (00-02), Fiesta (00-02), Focus (98-11), Focus C-Max (03-07), Galaxy (06-10), Mondeo (07-10), S-Max (06-14), Tourneo Connect (02-13), Transit Connect (02-13).

HERRAMIENTAS OEM

303-193 (21-104) (1), 303-393 (21-168) (2), 303-376 (21-162B) (3), 303-652 (21-230) (4), 310-095 (23-067) (5)

CÓDIGOS DE MOTOR

1.8D TDCi: BHPA, F9DA, F9DB, FFBA, FFDA, FFWA, HCPA, HCPB, KHBA, KKDA, KKDB, P7PA, P9PA, P9PB, QYBA, QYWA, R2PA, R3PA, RWPA, RWPC.
1.8D TDCi ECOnetic: KHBA.
1.8D Tdi: BHDA, BHDB, BHPA, C9DA, C9DB, C9DC.
1.8D Turbo: C9DC, RTN, RTP, RTQ.



KIT DE CALADO FORD

53324 12,50€

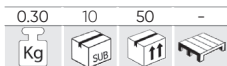

GASOLINA/PETROL



MARCAS	FORD: B-Max (15-17), C-Max (07-10), Cougar (98-01), Fiesta (95-17), Focus (98-11), Focus C-Max (03-07), Fusion (02-12), Galaxy (06-15), Maverick (01-07), Mondeo (93-15), Puma (97-02), S-Max (06-15), Tourneo Connect (02-06), Transit (06-12), Transit Connect (02-06). MAZDA: 121 ZQ (95-00), 2 DY (02-07), 3 BK (03-09), 3 BL (09-15), 5 CR (05-10), 5 CW (10-12), 6 GG/GY (02-07), 6 GH (07-15), MPV LW (02-05), MX-5 NC (05-16), Tribute EP (04-06). VOLVO: C30 (06-13), S40 (06-12), S80 (07-11), V50 (04-12).
HERRAMIENTAS OEM	FORD: 303-1054, 303-507 (21-210), 303-620 (21-163), 303-574, 303-748, 303-376 (21-162B), 303-376B MAZDA: 49 JE01 061, 303-574, 49 JE02 061, 303-465, 49 JE01 054 VOLVO: 999 7152, 999 7151.
CÓDIGOS DE MOTOR	1.4 / 1.6

KIT DE CALADO FORD / MAZDA

53294 119,00€



GASOIL/DIESEL

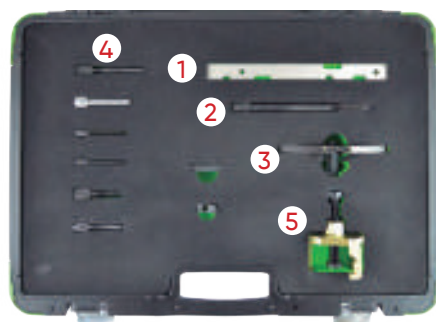

MARCAS	FORD: Courier (00-02), C-Max (03-10), Fiesta (02-11), Focus (98-11), Fusion (02-11), Galaxy (06-10), Kuga (06-10), Mondeo (07-10), S-Max (06-10), Tourneo Connect (02-13), Transit Connect (02-13). PEUGEOT: Bipper (08-10) Dispatch/Jumpy III (07-12) Expert III (07-12) Nemo (08-10) Partner I/II (05-11) Partner III (08-16) 107 (05-10) 1007 (05-10) 206 (01-12) 206+ (09-13) 206 CC (05-07) 207 (06-13) 207 CC (07-15) 208 (11-15) 307 (01-08) 308 (07-15) 308 CC (09-15) 407 (05-11) 508 (04-15) 2008 (13-15) 3008 (09-15) 4008 (12-15) 5008 (09-15). MAZDA: 2 (02-15), 3 (09-14). CITROËN: C1 (05-10), C2 (03-10), C3 I/II (02-10), C3 III (10-15), C3 Pluriel (04-10), C3 Picasso (09-12), C4 (04-11), C4 II (11-15), C4 Picasso (06-12), C4 Grand Picasso (10-12), DS3 (09-12), DS4 (11-12), DS5 (12-15), C5 II (04-08), C5 III (04-12), Xsara II (02-04), Xsara Picasso (04-10).
HERRAMIENTAS OEM	FORD: 303-376B (1), 303-193 (2), 303-393 (3), 303-732 (4), 303-651 (5), 303-393/01, 303-1059, 303-734, 303-735. MAZDA: 303-732, 303-734, 303-735. PSA: 0194-A, 0194-C, 0194B.
CÓDIGOS DE MOTOR	1.4D TDCi/Hdi: DV4TD(8HT), DV4TD(8HX), DV4TD(8HZ), DV4TD(8HW), DV4TED4(8HX), DV4TED4(8HV), DV4TED4(8HY), DV4C(8HP), DV4C(8HR), DV4TED(8HS), F6JA, F6JB, F6JC. 1.6D TDCi/HDi: DV6TED4(9HZ), DV6ATED4(9HX), DV6TED4(9HY), DV6DTED(9HP), DV6C(9HR), DV6CATED(9HX), DV6C(9HL), DV6TED(9HP), DV6ATED(9HY), DV6TED4(9HV), DV6TED4(9HX), DV6C(9HD), DV6C(BHX), DV6C(BHZ), DV6(9HR), DV6BTED4(9HW), DV6DTED(9HJ), DV6ETED(9HN), DV6TED4BU(9HS), DV6BTED4(9HT), DV6BUTED4(9HT), DV6TED4B(9HV), DV6UTED4(9HX), DV6TED(9HD), DV6UTED4(9HU), DV6D(9HP), DV6TE-D4(9HV), DV6C(9HD), DV6TED4(9HW), DV6AT(9HX), DV6ATED(9HX), DV6CTED(9HC), DV6AUTED4(9HX), DV6TED4B, DV6DTED(9HF), HHJA, HHJB, G8DA, G8DB, HHDA, HHDB, MZ-CD, Y6. 1.8D TDCi/HDi: BHPA, C9DA/B, FFBA, G6DA, G6DB, G6DC, HCPA, HCBP, KKDA, P7PA, P9PA, R2PA, R3PA, RWPA. 1.8ci: C9DC, RTN, RTQ. 1.8D Tdi: C9DA/B, C9DC. 2.0D TDCi/HDi: AZWA, G6DA, G6DB, G6DC, RHE(DW10CTED4), QXWA, QXWB.

KIT DE CALADO PARA BOMBA DE INYECCIÓN FORD / JAGUAR DURATORQ

53296 60,00€



GASOIL/DIESEL

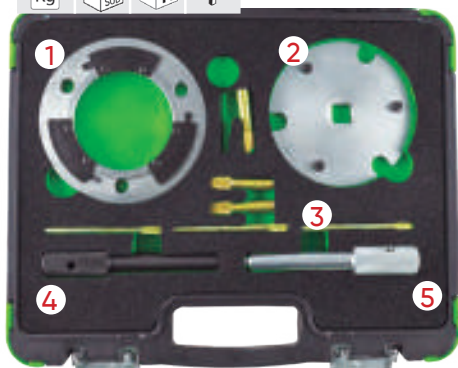

MARCAS	FORD: Mondeo (00-07), Transit (00-14). CITROËN: Relay/Jumper III (06-13). FIAT: Ducato (06-11). JAGUAR: X-Type (03-10). PEUGEOT: Boxer III (06-12). LAND ROVER: Defender Td4 (06-11). LDV: Convoy (02-06).
HERRAMIENTAS OEM	303-1151 (1), 303-679A/21-238 (2), 303-732 (3), 303-675/21-234 (4), 303-698/21-251 (5)
CÓDIGOS DE MOTOR	12.0D Di/TDci/TDCi: ABFA, D3FA, F3FA, D5BA, D6BA, F1FA, FMBA, FMBB, HJBA, HJBB, HJBC, HJBE, N7BA, N7BB. 2.2D TDCi/ECONetic: BG, CYFA, CYFB, CYFC, DRFA, DRFB, DRFC, P8FA, P8FB, PGFA, PGFB, QJBA, QJBA (BG), QJBB, QJBC, QJBD, QVFA, QWFA, SRFA, SRFB, SRFC, SRFD, SRFE, UHFA. 2.2D Hdi/JTD: P22DTE (4HM), P22DTE (4HU), P22DTE (4HV). 2.4D Di/TDCi: DOFA, D2FA, D2FB, D4FA, F4FA, FXFA, H9FA, H9FB, H9FD, JXFA, JXFC, PHFA, PHFC. 2.4D TD/Tdi: ZSD 424. 2.4D Tdi: 244DT.

KIT DE CALADO JAGUAR / LAND ROVER

53297 45,00€

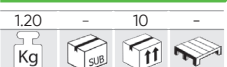

GASOIL/DIESEL

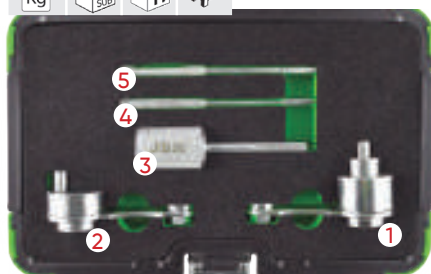

MARCAS	JAGUAR: MS TypeTDVi. LAND ROVER: Discovery 2.7 TDV6. RANGE ROVER: Sport 2.7 TDV6.
HERRAMIENTAS OEM	303-1117 (1), 303-1116 (2), 303-1132 (3), 303-1126 (4) (5)
CÓDIGOS DE MOTOR	276DT, 306DT.

IVA no incluido

KIT DE CALADO LAND ROVER

53298 91,00€

2.60 - 5 160
Kg SUB

GASOIL/DIESEL

MARCAS

MOTORES DIESEL: 200 TDI. 300 TDI. 2.5

- Pasador de sincronización de transmisión manual EDC.
- 200 TDI. 300 TDI. 2.5 Motores diésel.
- Extractor de amortiguador del cigüeñal.
- Herramienta de bloqueo de la bomba de inyección.
- Perno de sincronización de la bomba de inyección 200/300 TDI.
- Herramienta de sincronización del volante de motor 200/300 TDI.
- Herramienta de sincronización de bomba DPS 2.5.
- Herramienta de sincronización del volante de motor 2.5.



KIT DE CALADO OPEL / FORD / FIAT / ALFA ROMEO / LANCIA / SUZUKI

53452 26,50€

0.80 5 10 240
Kg SUB

GASOIL/DIESEL

MARCAS

VAUXHALL/OPEL 1.3 CDTi: Agila, Corsa, Combo (03-08), Astra-H(05-08), Meriva, Tigra-B(04-08)
SUZUKI 1.3 DDiS: Ignis, Wagon R(03-08), Swift(04-08)
FORD: 1.3 TDCi
FIAT/ALFA ROMEO/LANCIA: 1.3 JTD Multijet

HERRAMIENTAS OEM

104-A EN 46781 (1), EN 46785 (2)

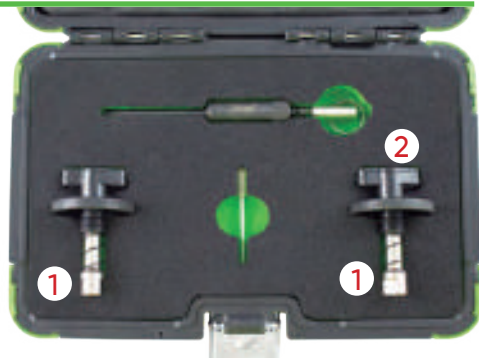

KIT DE CALADO OPEL / VAUXHALL / CHEVROLET 2.0CDI

53300 41,00€

1.25 - 10 270
Kg SUB

GASOIL/DIESEL

MARCAS

OPEL
VAUXHALL
CHEVROLET

HERRAMIENTAS OEM

EN-48245 (1), EN-48246 (2),
205083060 (3) (4) (5) (6)

CÓDIGOS DE MOTOR

OPEL / VAUXHALL: Z20DM, Z20DMH
CHEVROLET: LLWZ20DMH, RA 420, Z20Si, Z 20S3, Z 20S4, Z 20S5

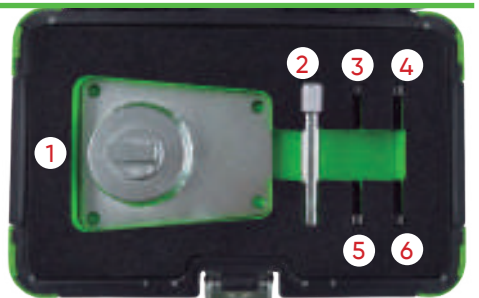

KIT DE CALADO OPEL / VAUXHALL

53299 291,00€

6.70 - 2 42
Kg SUB

GASOIL/DIESEL

MARCAS

OPEL / VAUXHALL

HERRAMIENTAS OEM

EN-46788 (1), KM927 (2), EN-46789 (3), KM929 (4), EN-46785 (5), EN-46788 (6), 1.860.985.000 (7), KM932 (8), KM933 (9), EN-49978 (10), KM933 (11)

CÓDIGOS DE MOTOR

1.3 CDTi 16V, 1.9 CDTi, 2.0 DTi, 2.2 DTi.



KIT DE CALADO PARA FIAT / OPEL / ALFA 1.9, 2.4L 16V

54216 49,00€

1.75 - 5 135
Kg SUB

GASOIL/DIESEL

MARCAS

Opel 1.9, Alfa-Romeo 1.9-2.4 L diesel, Fiat 1.9- 2.4 L diesel

HERRAMIENTAS OEM

Opel EN-46788 / Fiat 1.860.905.000 / 1.860.905.010 (1)
Fiat 1.860.898.000 (2)
Opel EN-46789 / Fiat 1.870.896.900 (3)
Opel KM 6130 / KM 6349 (4)

CÓDIGOS DE MOTOR

Opel 1.9 CDTi Z19DT, Z19DTH, Z19DTJ
Alfa-Romeo 1.9 y 2.4 L : 323.02, 371.01, 342.02, 325.01, 362.02, 182B9.000, 937A2.000, 937A3.000, 192A5.000, 192B1.000, 937A4.000, 937A5.000, 939A2.000, 939A1.000, 939A7.000, 939A8.000, 839A6.000, 841C.000
Fiat 1.9 y 2.4 L : 182B4.000, 182B9.000, 185A6.000, 186A6.000, 186A8.000, 186A9.000, 188A2.000, 188A7.000, 188B2.000, 192A1.000, 192A3.000, 192A5.000, 192A8.000, 192A9.000, 192B4.000, 192B5.000 198A2.000, 198A3.000, 198A6.000, 199A5.000 223A7.000, 937A5.000, 939A1.000, 939A2.000 939A3.000, 939A7.000



KIT DE CALADO OPEL / VAUXHALL 1.0 , 1.2 , 1.4 TURBO

53651

91,00€

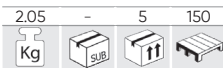

GASOLINA/PETROL



MARCAS	OPEL: Adam, Ampera, Astra-J, Aveo, Corsa-D, Insignia, Meriva-B, Mokka, Zafira-C Tourer
HERRAMIENTAS OEM	EN 49977-100 (1), EN 49977-200 (2), EN 49978 (3), KM 952 (4), KM 953-A (5), KM 955-1 (6), KM 955-2 (7).
CÓDIGOS DE MOTOR	10: A10XEP (LDB) 12: A12XEL (LWD), A12XER (LDC) 14: A14XEL (L2Z), A14XER (LDD), LDU A14NEL (LUH), A14NET (LUJ), Twinport / ecoFLEX engines A14XFL (LUU), A14NEL (LDD), A14NEL (LUJ), A12XEL (L2Q)

KIT DE CALADO OPEL 1.0 , 1.2 , 1.4

53301

44,00€

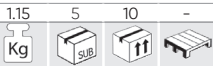

GASOLINA/PETROL

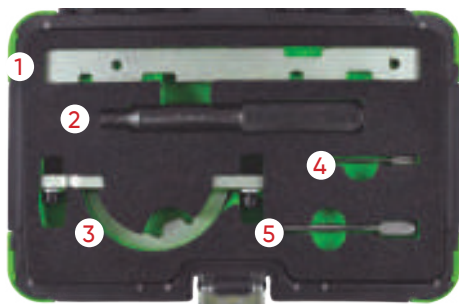

MARCAS	SUZUKI: Wagon R (05-08). VAUXHALL / OPEL: Agila (00-08), Astra-G (98-06), Astra G Classic II (03-10), Astra-H (04-11), Combo (04-12), Corsa-B (97-00), Corsa-C (00-07), Corsa-D (06-12), Meriva-A (04-10), Tigra-B (04-10).
HERRAMIENTAS OEM	KM-953/09919-58310 (1), KM-952/09912-38310 (2), KM-954/09919-08310 (3), KM-6130 (4), KM-955/09919-58320 (5)
CÓDIGOS DE MOTOR	1.0 12v: X10XE, Z10XE, Z10XEP. 1.2 16v: X12XE, Z12XE, Z12XEP. 1.4 16v/ecoFLEX: Z14XEL, Z14XEP.

KIT DE CALADO PARA VAUXHALL , OPEL 1.3 CDTI

54221

111,00€

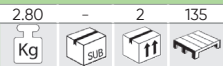

GASOIL/DIESEL



MARCAS	Vauxhall/ Opel 1.3 CDTI Corsa E Diesel Engine From 2015
HERRAMIENTAS OEM	KM-662-C(1), EN-50515(2), EN-51500(3), EN-46775(4), KM-955-1(5), EN-46785.(6)
CÓDIGOS DE MOTOR	LKU B13DTE, LKU B13DTR

KIT DE CALADO PARA VAUXHALL / OPEL / SAAB 2.0, 2.2 DTI

54217

104,00€



GASOIL/DIESEL



MARCAS	Vauxhall/Opel:Astra-G (98-06), Frontera-B (98-04), Omega-B, (98-03), Signum (03-05), Sintra (98-99), Vectra-B (97-02), Vectra-C (02-05), Zafira-A (99-05), Saab: 9-3 (98-04), 9-5 (02-06)
HERRAMIENTAS OEM	Saab: 83 95 394(1), 83 95 337 (2), 83 95 352(3), 83 95 386(4)Vauxhall/Opel/ Saab: KM-927(2), KM-929(3), KM-932 (4),KM-933(1)
CÓDIGOS DE MOTOR	Opel: X20DTH,X20DTL,Y20DTH, Y20DTL, X22DYH,Y22DTH, Y22DTR Saab: D223L

KIT DE CALADO FIAT / OPEL

53303 89,00€

GASOIL/DIESEL

1,96	-	5	150
Kg	Sub	ft	

MARCAS	FIAT: 1.9D / JTD (Motor Peugeot), 2.4D. ALFA ROMEO: 145, 146, 156 JTD. GM: GM 1.3, 1.6, 1.9, 2.0, 2.4 CDTI (2004 -).
HERRAMIENTAS OEM	EN-46789 (1), EN-46789-100 (2), EN-46785 (3), EN-46788 (4), EN-46781 (5), EN-46789 (6)
CÓDIGOS DE MOTOR	GM: K1.3 CDTI Z13DT Common Rail engine. 1.9 CDTi / 04-12 - Z19DT Z19DTH Z19DTJ Z19DTL 2.0 CDTi / 08-12 - A20DT LBS / LBX / LBY / LCD.V SAAB: 1.9 TiD.



KIT DE CALADO OPEL / VAUXHALL ASTRA, VECTRA, ZAFIRA 1.9CDTI

53302 44,00€

GASOIL/DIESEL

1,10	5	10	640
Kg	Sub	ft	

MARCAS	SAAB: 9-3 (04-08), 9-5 (05-08). VAUXHALL / OPEL: Astra-H, Vectra-C, Signum (04-07), Zafira-B (05-07).
HERRAMIENTAS OEM	EN46789/32 025 008 (1) (3), EN46788/32 025 009 (2), KM6349 (4)
CÓDIGOS DE MOTOR	Z19DT, Z19DTH, Z19DTL.

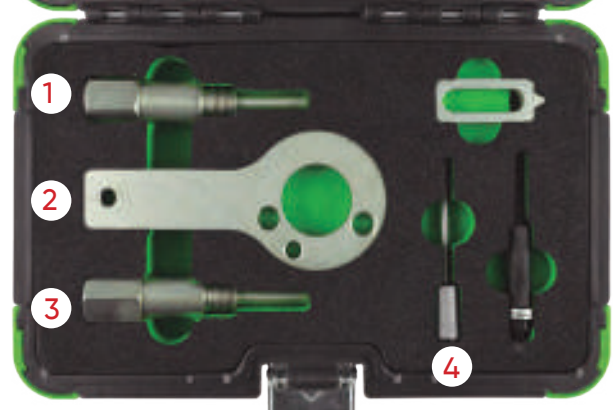

KIT DE CALADO SAAB / OPEL / VAUXHALL

53305 136,00€

GASOLINA/PETROL

3,60	-	2	42
Kg	Sub	ft	

MARCAS	VAUXHALL / OPEL: Antara (06-10), Calibra (93-98), Cavalier / Vectra-A (93-95), Omega-B (94-03), Signum (03-05), Sintra (96-99), Vectra-B (95-02), Vectra-C (02-05). SAAB: 900 (93-98), 9000 (95-97), 9-5 (98-03)
HERRAMIENTAS OEM	KM-800-1 (1), KM-800-2 (2), KM-800-20 (3), KM-800-10 (4), 83 95 006 (5), KM-800-30 (6), MKM-6038, 83 95 006 (7)
CÓDIGOS DE MOTOR	2,5 V6: Saab; B2581, Vauxhall / Opel; C25XE, X25XE. 2,6 V6: Vauxhall / Opel; Y26SE. 3,0 V6: Saab; B308E, B308i, Vauxhall / Opel; X30XE. 3,2 V6: Vauxhall / Opel; Y32SE.

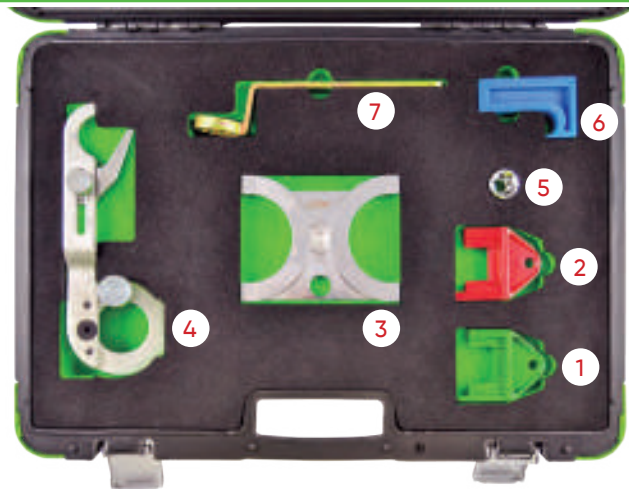

KIT DE CALADO FIAT

53304 279,00€

GASOLINA/PETROL

6,00	-	2	42
Kg	Sub	ft	

GASOIL/DIESEL

MARCAS	FIAT
HERRAMIENTAS OEM	1 860 874 000 (1), 1 860 895 000 (2), 1 860 898 000 (3), 1 860 905 000 (4), 1 860 845 000 (5)
CÓDIGOS DE MOTOR	MOTORES GASOLINA: Fiat Brava, Bravo, Barchetta, Cargo, Coupe, Marea, Palio, Weekend, Punto, Multila, Stilo, Idea, Doble Twin Cam Engines - 1.2, 1.4, 1.6, 1.8, 16V MOTORES DIESEL: Fiat Brava, Bravo, Marea, Weekend, Palio, Punto, Multitpla, Doble, Ulysse, Ducato, Stilo JTD Diesel Engines - 1.9D / TD . 1.9JTD . 2.4TD / JTD.

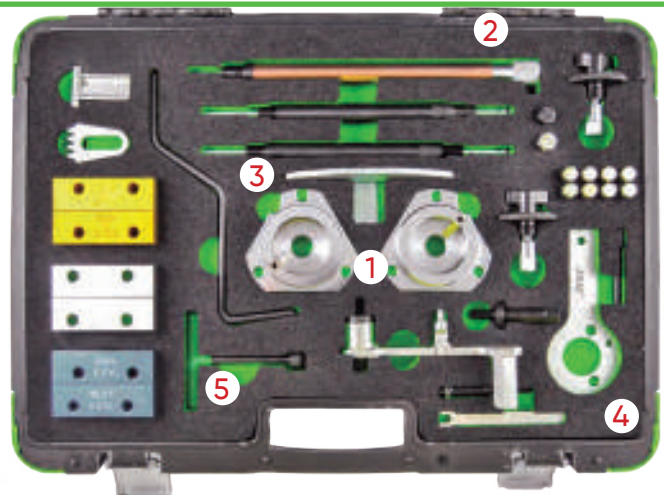

KIT DE CALADO ALFA / OPEL / VAUXHALL 1.6, 1.8 16V

53307 38,50€

GASOLINA/PETROL

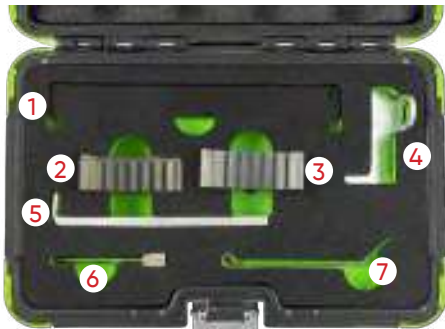
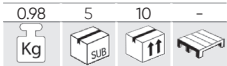

MARCAS	OPEL / VAUXHALL: Corsa-D, Agila, Astra-G-H, Meriva, Zafira-B, Vectra-C, Signum, Insignia	1.6, 1.8
	CHEVROLET: Aveo, Cruze, Orlando	1.4, 1.6, 1.8
	ALFA ROMEO: 159 FIAT: Croma	1.8
HERRAMIENTAS OEM	E10290 (1), 23056-06 (2) (3), E10230 (4), 23164-04 (5), 23174-01 (6), 23056-05 (7)	
CÓDIGOS DE MOTOR	OpeL / Vauxhall: Z16LEL, Z16LER, Z16LET, Z16XE1, Z16XEP, Z16XER, A16XER, 18XER, A18XER, 2HO/A18XEL. Chevrolet: G14D, LDD, LXV (F16D4), 2HO(Z18XER). Alfa / Fiat: 939A4.000.	

KIT DE CALADO FIAT / OPEL / VAUXHALL 2.2 16V CADENA

53316 34,00€

GASOLINA/PETROL

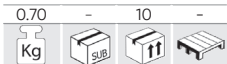

MARCAS	OPEL: Astra-G (2000-2006), Astra-H (2006-2011), Signum (2003-2008), Vectra-B (2000-2002), Vectra-C (2002-2008), Zafira-A (2000-2005), Zafira-B (2005-2012), Speedster (2000-2006). VAUXHALL: VX220 (2000-2006). FIAT: Croma (2005-2009).	
CÓDIGOS DE MOTOR	VAUXHALL / OPEL: Z22SE, Z22YH FIAT: 194A1.000.	

KIT DE CALADO PARA VAUXHALL/ OPEL 1.6 CDTI

54205 49,00€

GASOIL/DIESEL

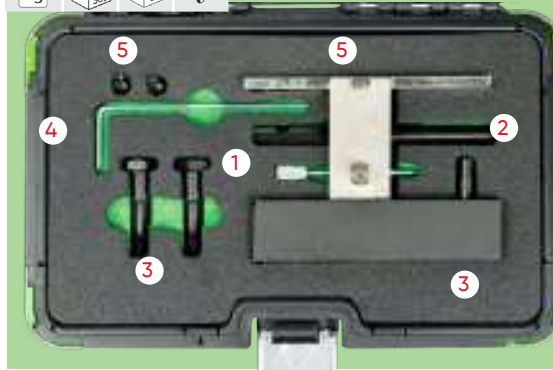

MARCAS	Vauxhall/Opel: Astra J (13-18), Astra K, (15-19), GTC (15-18), Insignia A (15-17), Insignia- B (17-20), Meriva B (13-17), Mokka (14-16), Mokka X (16-20), Zafira C Tourer (13-19).	
HERRAMIENTAS OEM	EN-6349, EN-6130 (1), EN-51143 (2), EN-51140 (3), EN-50513 (4), EN-51188 (5)	
CÓDIGOS DE MOTOR	B16DTC, B16DTE, B16DTH, B16DTJ, B16DTL, B16DTN, B16DTR and B16DTU. D16DTH,D16DTI,D16DTJ,D16DTN, D16DTR,D16DTU	

KIT DE CALADO PARA OPEL 1.6D, 1.7D ISUZU

54214 96,00€

GASOIL/DIESEL

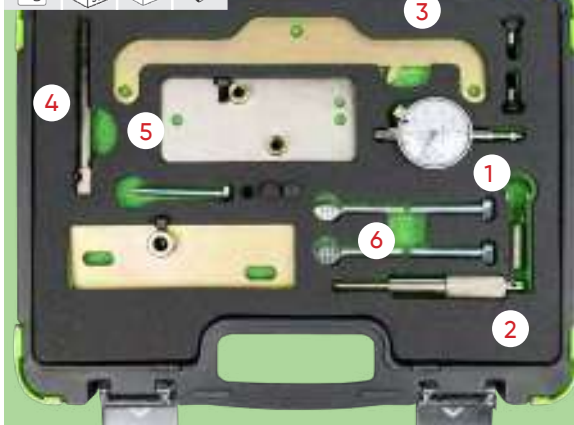
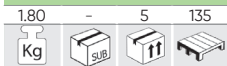

MARCAS	ASTRA, CAVALIES, VECTRA-A(87-00), ISUZU, NOVA, CORSA / COMBO, STRA, CAVALIER, VECTRA, FRONTERA, MONTEREY, MIDI, BRAVA (88-04)	
HERRAMIENTAS OEM	VAS 6079 (1), KM 951 (2), KM 851 (3), 23-029 (4), KM 661-2 (5), KM 661 (6)	
CÓDIGOS DE MOTOR	OPEL : 16DA, 17D, 17DR, X17DTL ISUZU : 4EC1, 4EE1, 4JB1, 4XJ1, 4JA1, 4JG1, 4FC1, 4FD1, 4FG1, Z17DT, Y17DT/DTL	

KIT DE CALADO CITROËN / PEUGEOT

53313 139,00€

GASOLINA/PETROL

4,55	-	2	40
Kg	Sub	Box	Tray

GASOIL/DIESEL

MARCAS

CITROËN: AX, BX, Boxer, Berlingo, C25, Dispatch, Evasion, J5, Jumpy, Jumper, Relay, Saxo, Synergie, Visa, XM, Xsara, Xantia, XZ, ZX.
PEUGEOT: 106, 205, 206, 305, 306, 307, 309, 405, 406, 605, 607, 806, Expert, Partner, Solara, Talbot.

HERRAMIENTAS OEM

7099TM (1), 0188X (2), 0188P (3), 0189AZ (4), 0188H (5), 0132AJ1 (6), 0189A (7), 0188PM (8), 21-260 (9), 4527-TS1 (10), M8X70 (11), 0188K (12), 0188J (13), 0132Q (14), 4507-TL (15), 4507-TJ (16), 9044-T (17), 4507-TJ (18), 5711-TA (19), 7014-TJ (20), 7017-TR (21), 0188X (22), 7017-TW (23), 7014-TM (24), 0189L (25)

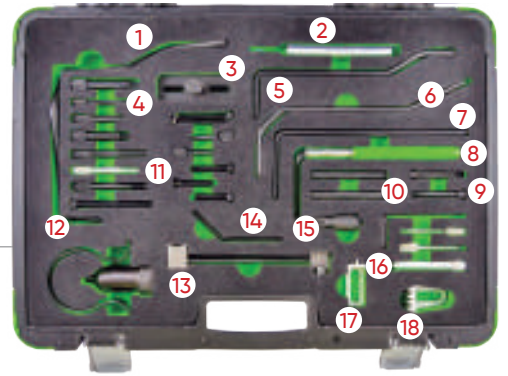

KIT DE CALADO CITROËN / PEUGEOT 1.8 , 2.0

53314 98,00€

GASOLINA/PETROL

1,85	-	2	-
Kg	Sub	Box	Tray

MARCAS

CITROËN: C4 Picasso/Grand Picasso (06-10), C5 II (04-08), C8 (05-10), Dispatch/Jumpy (07-11), Xsara 2.0 16v, C5 1.8/2.0/HPI, Xsara Picasso 1.8/2.0 16v (02-05)
PEUGEOT: 406 1.8 16v (00-04), 407 (06-10), 807 2.0 16v (02-05).

HERRAMIENTAS OEM

0189S2 (1), 0188J (2), 0188J2 (2), 0189S1 (3), 21-260 (4), 0189B (5), 0188M (6), 0188AH (7), 0189R (8)

CÓDIGOS DE MOTOR

1.8 16v: EW7A(6FY).
2.0 16v: EW10A(RFJ), EW10ABE4(RFH), EW10J4S (RFK).

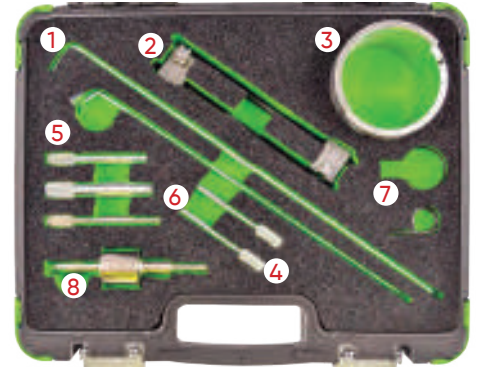

KIT DE CALADO RENAULT / NISSAN / OPEL / VAUXHALL 2.0 , 2.3 DCI , CDTI M9R , M9T

53311 97,00€

GASOIL/DIESEL

2,55	-	5	135
Kg	Sub	Box	Tray

MARCAS

NISSAN: Primastar X83 (06-15), Qashqai/Qashqai+2 J10 (07-14), X-Trail T31 (07-14).
VAUXHALL/OPEL: Movano-B (10-17), Vivaro (06-15).
RENAULT: Espace/Grand Espace IV (06-10), Koleos (08-15), Laguna II (05-07), Laguna III (07-14), Master III (10-15), Megane II (06-10), Scenic/Grand Scenic II (06-09), Scenic/Grand Scenic III (09-15), Trafic II (06-14), Vel Satis (05-10)

HERRAMIENTAS OEM

Mot1769 (1), EN-48334 (2), Mot1766 (3), EN-48330 (3), KM-6130 (4), EN-48332 (5), Mot1773 (6), EN-48831 (6)

CÓDIGOS DE MOTOR

2.0D dCi M9R: 630, 780, 782, 784, 786, 788, 830, 832, 833, 834, 835, 836, 838, 855, 856.
2.0D CDTI M9R: 630, 780, 782, 784, 786.
2.3 Bi-CDTI: LP6/M9T706, LW7/M9T706.
2.3D dCi M9T: 670, 672, 676, 678, 680, 686, 690, 692, 694, 698.



KIT DE CALADO CITROËN / PEUGEOT 1.0 , 1.2 VTI

53876 64,00€

GASOLINA/PETROL

1,80	-	5	120
Kg	Sub	Box	Tray

MARCAS

CITROËN: C3 (III)
PEUGEOT: 208, 308, 2008 SUV (2012-2014)

HERRAMIENTAS OEM

0109-2A (1),
0109-2B (2)

CÓDIGOS DE MOTOR

1.0/1.2 VTI.
EBO, (ZMZ), EB2, (HMZ)

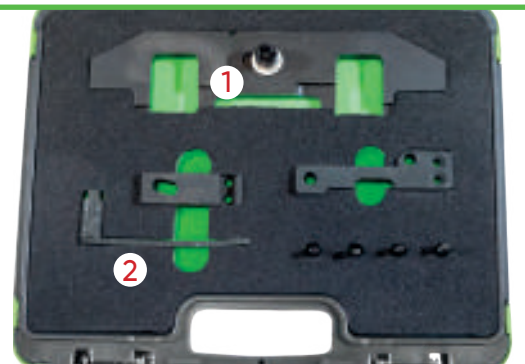

KIT DE CALADO PARA ROVER / PEUGEOT / FORD / VOLVO 2.0 , 2.2L D

54213 19,80€

GASOIL/DIESEL

0,40	6	24	240
Kg	Sub	Box	Tray

MARCAS

Peugeot: 807 (05-11), 407 (05-11), 607 (05-09). Citroën: C4 (04-10), C5 II (04-10). Land Rover: Freelander (06-10). Volvo: S40 (03-10), V50 (06-10), C70 (06-10), S80 (07-10), C30 (06-10), V70 (07-10). Ford: S Max 2.2 (08-10), Galaxy 2.2 (08-10), Mondeo 2.2, 2.0 (07-10).

HERRAMIENTAS OEM

PSA 0188.M, Ford 303-735, 303-1277, Volvo 999-7122 (1)
PSA 0188.X, Ford 303-1059, 303-1270, Volvo 999-7121 (2)
PSA 0188.F, Ford 303-393A, 303-393-01, 303-1272, Volvo 999-7119/7120 (3)

CÓDIGOS DE MOTOR

PEUGEOT: DW10UTED4 (RHK), DW10BTED4 (RHR), DW12BTED4 (4HS), (4HP), (4HT), (4HR).
Citroën: DW10BTED4 (RHR). LAND ROVER: DW12BTED4, 224DT. Volvo: D420T 2.0D. FORD: QXBA(2.2), QXWA(2.0), QXBB(2.0), Q4BA(2.2), QXWA(2.0), QXWB(2.0), AZBA(2.0), AZBC(2.0), AZWA(2.0)

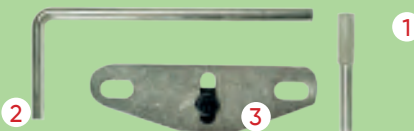

KIT DE CALADO ALFA / FIAT / LANCIA



MARCAS	ALFA FIAT LANCIA	Alfa, Barchetta, Bravo, Brava, Coupe, Delta, Dedra, Punto, Spider, GT
HERRAMIENTAS OEM	1860845000 (1), 1822154000 (2), 1860905000 (3), 1860992000 (4), 1860895000 (5), 1860874000 (6), 1860985000 (7), KM571A (8), 1 860 896 000 (9), 0153A (10)	
CÓDIGOS DE MOTOR	1.2 / 16V, 1.4 / 12V, 1.6 / 16V, 1.6 eco, 1.8, 2.0 / 16V, 2.0 / 20V, 2.4 / 20V, 3.0 / V6.	

KIT DE CALADO FIAT/ALFA ROMEO/LANCIA



MARCAS	<i>Alfa Romeo:</i> Giulietta (10-14), MiTo (08-17), <i>Fiat:</i> 500 (07-19), 500L (12-19), 500C (07-19), 500 Abarth (08-17), Bravo (07-14), Brava/Bravo (98-02), Doblo/Doblo Cargo (10-19), Egea (15-20), Grande Punto (07-10), Grande Punto Abarth (07-10), Idea (04-12), Linea (07-10), Marea/Weekend (98-00), Palio Weekend (01-06), Panda (07-11), Punto (97-08), Stilo (01-08), Tipo (15-20). <i>Lancia:</i> Delta (08-12), Musa (04-13), Ypsilon (96-11).
HERRAMIENTAS OEM	2.000.004.500 (1), 1.860.985.000 (2), 1.860.992.000 (3), 1.860.987.000 (4), 2.000.015.800 (5)
CÓDIGOS DE MOTOR	1.2 16v:176B9.000, 182B2.000, 188A5.000. 1.4 16v / T-Jet: 169A3.000, 192B2.000, 198A1.000, 198A4.000, 199A6.000, 198A8.000, 312A1.000, 312A3.000, 843A1.000, 955A1.000.

KIT DE CALADO FIAT / ALFA / FORD



MARCAS	<i>FIAT:</i> New 500 (07-09), Idea (04-09), Linea (07-09), Grande Punto (07-09), Doblo 1 Cargo (05-09), Panda EV02 (05) <i>FORD:</i> KA 1.2 Duratec (09) <i>ALFA ROMEO</i>
HERRAMIENTAS OEM	1 860 987 000 (1), 2 000 004 400 (2), 2 000 015 800 (3), 2 000 004 300 (4), 2 000 004 500 (5)
CÓDIGOS DE MOTOR	1.2: 169A4.000 / 199A4.000. 1.4: 350A 1.000 / 188A4.000-EV02.

KIT DE CALADO PARA ALFA ROMEO, LANCIA 1.75 TBI



MARCAS	Alfa Romeo: 159(09-12), Brera(09-11), Giulietta(10-19), Spider(09-11), 4C(13-19). Lancia: Delta(09-14).
HERRAMIENTAS OEM	2 000033500 (1), 2000 003000 (2), 1860898 000 (3).
CÓDIGOS DE MOTOR	Alfa Romeo 1,75 Tbi: 939B1.000, 940A1.000, 940B2.000, 960A1.000 Lancia 1,75 DI Turbo Jet: 939B1.000

KIT DE CALADO FIAT 1.2 16V

53306 53,00€

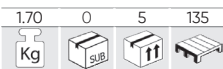

GASOLINA/PETROL

MARCAS	FIAT: Fiat 1.2L 16V, Fiat Punto / Brava / Bravo / Stilo
HERRAMIENTAS OEM	1860992000 (1) (2), 1871000900 (3), 1860987000 (4), 1869850000 (5)
CÓDIGOS DE MOTOR	176 B9.000, 182 B2.000, 188 A5.000



KIT DE CALADO FIAT / IVECO 2.3 , 3.0 JTD

53319 18,00€

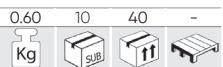

GASOIL/DIESEL

MARCAS	FIAT: 2.3 / 3.0 JTD. IVECO: Daily.
HERRAMIENTAS OEM	99360614, 1 860 617 000, 99360615, 2 000 018 200.
CÓDIGOS DE MOTOR	F1AE0481C, F1AE0481D, F1AE0481N, F1CE0481A/D.

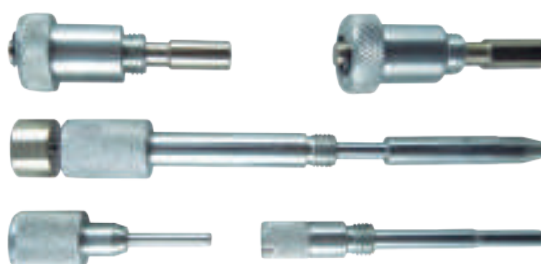

KIT DE CALADO ALFA / FIAT / LANCIA 1.4 , 1.6 , 1.8 , 2.0 16V

53309 285,00€



GASOLINA/PETROL

MARCAS	ALFA ROMEO: 145,146,147,155,156, 1.4 1.6 1.8 2.0 TS, 1.4/1.6 16V; 145/146/147/155/156 (96-10), 1.8 16V; 145/146, (96-01), 155/156 (96-06), Spider/GTV (98-05), 2.0 16V; 145/146 (96-01), 147 (01-10), 155/156 (95-02), 166 (98-07), Spider/GTV (96-05), Purpur: 1.4, 1.6 // Blau: 1.8, 2.0 FIAT: Barchetta (96-00), Brava (95-00), Bravo (95-00), Coupe (96-01), Marea (96-00), Marea Weekend (96-00), Punto/Punto Classic (99-06), Stilo (01-08) LANCIA: Dedra (95-99), Delta (96-99), Kappa (98-02), Lybra (99-06).
CÓDIGOS DE MOTOR	1.4 16v: 335.03 1.6 16v: 321.02, 321.03, 321.04, 372.03, 676.01 1.8 16v: 322.01, 322.05, 671.06, 182A2.000, 183A1.000, 183A6.000, 188A6.000, 192A4.000 2.0 16v: 162.01, 323.01, 323.1, 341.03, 363.01, 672.04 2.0 20v: 175A3.000, 182A1.000, 182B7.000, 185A8.000.



KIT DE CALADO PARA FIAT, LANCIA 1.4 12V

54212 39,40€



GASOLINA/PETROL

MARCAS	Marea/Marea Weekend(96-20), Brava(95-98), Bravo(95-98), Lancia, Ypsilon(96-20)
HERRAMIENTAS OEM	1860899000 (1), 1860901000 (2)
CÓDIGOS DE MOTOR	1.4 12v : 182A3.000, 182A5.000.

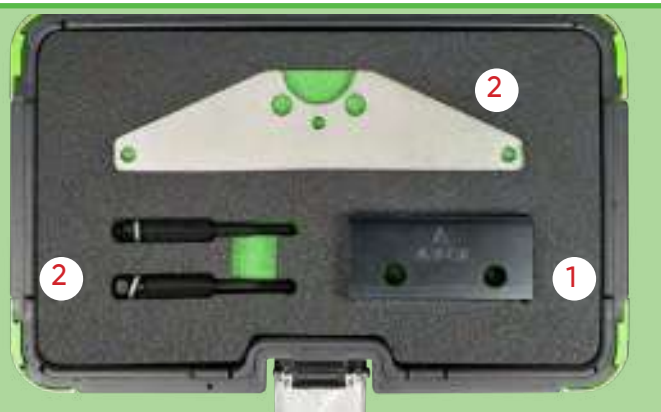

KIT DE CALADO PARA ALFA ROMEO / FIAT 1.4 MULTI AIR

53308

55,00€

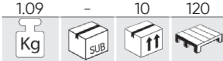

GASOLINA/PETROL

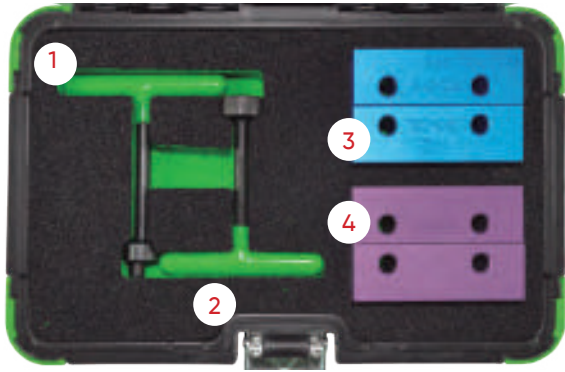

MARCAS	ALFA ROMEO: 145,146,147,155,156, 1.4 1.6 1.8 2.0 TS, 1.4/1.6 16V; 145/146/147/155/156 (96-10), 1.8 16V; 145/146, (96-01), 155/156 (96-06), Spider/GTV (98-05), 2.0 16V; 145/146 (96-01), 147 (01-10), 155/156 (95-02), 166 (98-07), Spider/GTV (96-05), Púrpura / Purple: 1.4, 1.6 // Azul / Blue: 1.8, 2.0
HERRAMIENTAS OEM	1822149000 (1), 1822154000 (2), 1825041000 (3), 1825042000 (4)
CÓDIGOS DE MOTOR	Z14/1.6-321.02, 321.03, 321.04, 335.03, 676.01 1.8/2.0-323.01, 672.04, 162.01, 323.10, 671.06, 322.01, 671.02, 322.05, 341.03, 363.01.

KIT DE CALADO PARA ALFA ROMEO / FIAT 1.4 MULTI AIR

54215

57,00€

GASOLINA/PETROL

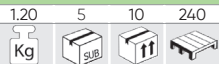

MARCAS	Alfa Romeo Giulietta, Mito / Fiat Punto, Punto Evo 1.4 (Turbo) MultiAir (105/135/163/170PS)
HERRAMIENTAS OEM	Alfa Romeo / Fiat: 1860987000 (1), 2000034400 (2), 2000004500 (3)
CÓDIGOS DE MOTOR	940A2.000 / 940A2.000 / 955A8.000 / 955A8.000 / 940A2.000 / 955A8.000 / 955A2.000 / 955A7.000 / 955A6.000 / 955A8.000

KIT DE CALADO FIAT / ALFA / LANCIA / OPEL / SUZUKI / FORD

53773

298,00€

GASOLINA/PETROL

GASOIL/DIESEL

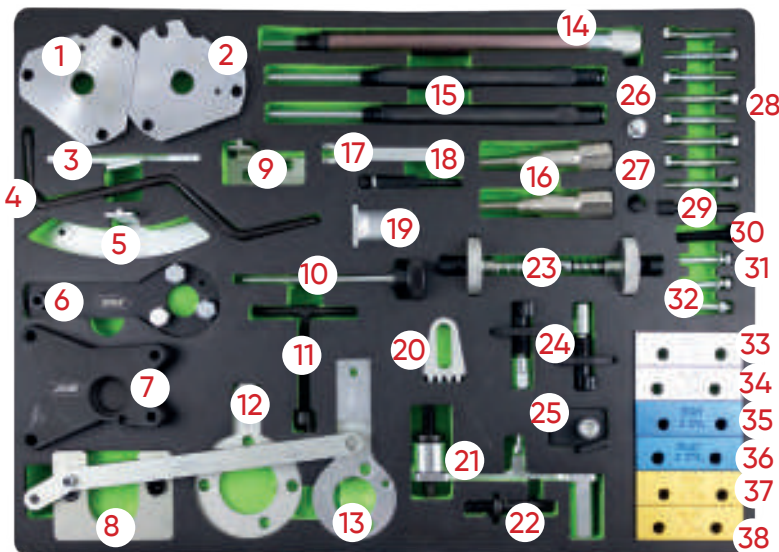

MARCAS	ALFA: Romeo 145, 146, 147, 155, 156, 159, 166, Spider, GTV, TS, GT, Crosswagon Q4 FIAT: Punto, Grande Punto, Brava, Bravo, Marea, Weekend, Stilo, Doblo, Cargo, Idea, Panda, Multipla, Palio, Stilo, 500 LANCIA: Lybra, Ypsilon, Thesis, Musa OPEL: Corsa, Agila, Meriva, Combo, Vectra, Zara, Astra, Insignia, Signum 1.9 CDTI SUZUKI: Ignis, Swift, Wagon R+ FORD: Ka
HERRAMIENTAS OEM	1860874000 (1), 1860874000 (2), 2000004400 / 2190754400 (3), 1860863000 (4), 1860898000 (5), 2190754500 (6), 2000004300 (7), 1870900400 (8), 1860703000 (9), 1860933000 (10), 1860845000 (11), 1870900300 (12), 1860905000 / EN-46788 (13), 1895443000 (14), 1860992000 (15), 1870896900 (16), 1860987000 (17), 1860905000 (18), 1860771000 (19), 1860161000 (20), 1860876000 (21), 1860876000 (22), 1871000900 (23), 1860985000 (24), 2000004200 / 2190754200 (25), 1860965000 (29)

CÓDIGOS DE MOTOR

176B9.000, 182B2.000, 188A5.000, 843A1.000, 323.02, 371.01, 182B4.000, 182B9.000, 186A6.000, 188A2.000, 188A7.000, 188B2.000, 192A1.000, 192A3.000, 937A2.000, 939A1.000, 192A5.000, 192B1.000, 198A5.000, 937A5.000, 939A2.000, 325.01, 342.02, 362.02, 185A6.000, 841C.000, 841G.000, 939A3.000, 940A3.000, 940A4.000, 940A5.000, Z19DT/DTH/DTR/DTJ/DTL, 169A1.000, 955A4.000, 350A3.000, 192B4.000, 198A2.000, 350A2.000, 955A3.000, 192A8.000, 198A6.000, 198A3.000, 199B1.000, 199B2.000, 199A2.000, 199A3.000, 199A9.000, 188A3.000, 188A8.000, 188A9.000, 192A9.000, 186A8.000, 186A9.000, 199A5.000, 223A7.000, 223A9.000, 841H.000, 841P.000, 185A2.000, Z13DT, Z13DTJ, Z13DTH, 182A4.000, 182A6.000, 182B6.000, 178B3.000, 186A3.000, 186A4.000, 350A1.000, 169A4.000, 188A4.000, 199A4.000, 199A7.000

KIT DE CALADO FORD / SEAT / VOLKSWAGEN / MAZDA / VOLVO

53770 198,00€

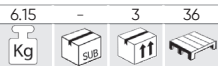

GASOLINA/PETROL

GASOIL/DIESEL

MARCAS	FORD: Fiesta, Fusion, Courier, Escort, Focus, Focus C Max, Puma, Mondeo, Sierra, Cougar, Galaxy, C-Max, Orion, Tourneo Connect, Transit, Transit Connect. VW: Sharan. SEAT: Alhambra. MAZDA: 121. VOLVO: S40, V50.
HERRAMIENTAS OEM	303-1061 (1), 303-1054 (2), 23-059 / 310-085 (3), 21-105 (4), 323-029 (6), 0194-B / 21-263 / 303-735 / 49 JE 02 021 (7), 0132-AB / 0178-D / 21-151 (9), 0194-C, 21-262, 303-734, 49 JE 02 020 (10), 21-238 / 303-679A / 303-1151 (11), 21-238 / 303-679A / 303-1151 (12), 303-1054 (13), 303-1151 (14), 21-238 / 303-679A (15), 303-393 / 303-393-02 (16), 303-1097 (17), 21-168 / 303-393 (18), 303-0985 (20), 2064 / 23-047 / 310-055 / U20003 (21), 303-652 (22), 21-229, 303-651 (23), 303-748 (24), 21-210 (25), 21-260, 303-732 (26), 21-163, 303-620 (27), 21-234 / 21-251 (28), 303-675 / 303-698 (29), 21-104 / 303-193 (30) / 21-162B / 303-367 / 303-376 (31), 21-162B / 303-376 / 303-376B (32), 23-019 (33), 23-058 / 310-084 (34), 0153-M / 0178-C / 0178-D (35), 0178-B / 5711-TB (36), 21-123 (37), 23-020 (38), 21-234 / 21-251 (39), 303-1059 (40), 23-019 (41), 303-1060 (42), 303-393 / 303-393-01 (43)
CÓDIGOS DE MOTOR	FUJA, FUJB, FXJA, FXJB, FXJJB, FYJA, FYJB, F8JA, F8JB, M7JA, M7JB, DHA, DHB, DHC, DHD, DHE, DHF, DHG, FHA, FHE, LIT, LIV, LIE, LIG, LIH, LIK, RDA, RDB, RKC, RQB, RQC, FXDA/C, FXDB/D, FYDA/C, FYDB/D, FYDH, HWDAIZ, AHU, AVG, AFN, D24, D24T, D24TIC, RFN, RTJ, RTK, RVA, RFK, RKD, B4164S3, DV4TD (8HV/8HX/8HZ), DV4TED4(8HV/8HY), DV6ATED4 (9HX/9HY/9HZ) F6JA, F6JB, F6JC, G8DA, G8DB, KKDA, SNJA, SNJB, STJA, STJB, ASDA, ASDB, FXJC, SPJA, SPJC, FYJC, HWDA, HWDB, SHDA, SHDB, SHDC, JQDA, LQDB, JTDA, JTDB, HXDA, HXJA, HXJB, IQDA/B, IQDB, PNBA, PNDA, RHBA, SIDA, F6JD, TZJA, TZJB, HHDA, HHDB, HHJA, HHJC, HHJD, HHJE, HHJF, RTA, RTB, RTC, RTD, RTG, RTE, RTF, RTH, RTJ, RTK, RFN, BHPA, HCPA, HCPB, KKDA, P7PA, P9PA, P9PB, R2PA, R3PA, RWPA, RWPC, F9DA/B, FFBA, FFWA, KHBA, QYBA, QYWA, KKDB, C9DC, RVA, IZ, AFN, AHU, ANU, AUY, G6DA, G6DB, G6DC, G6DD, G6DE, G6DF, G6DG, UFDB, TXDB, TYDA, UKDB, QXBA, AZBA, KLBA, QXBB, LPBA, AZBC, TYBA, UKBA, UFBA, TXBA, IXDA, QXWA, QXWB, AZWA, KLWA, AZWC, TYWA, UKWA, TXWA, UFWA, UFDA, TXDA, UKDA, Q4BA, KNBA, 4BA, 4BB, 4BC, 4CC, 4FA, 4CA, 4CB, 4DA, 4EA, 4FA, 4FB, 4FC, 4FD, 4GA, 4HB, 4HC, 4EB, 4EC, 4ED 4GA, 4GB, 4GC, 4GD, 4GE, 4GF, 4HA, 4HD, FMBA/B, D5BA, ABFA, D3FA, D6BA, HJBA/B, F3FA, D2FA, D4FA, F4FA, F5FA, DOFA, QJBA, QJBB, QJBC, QJBD, FXFA, H9FA, H9FB, N7BA, N7BB, MZ-CD 1.6, Y6

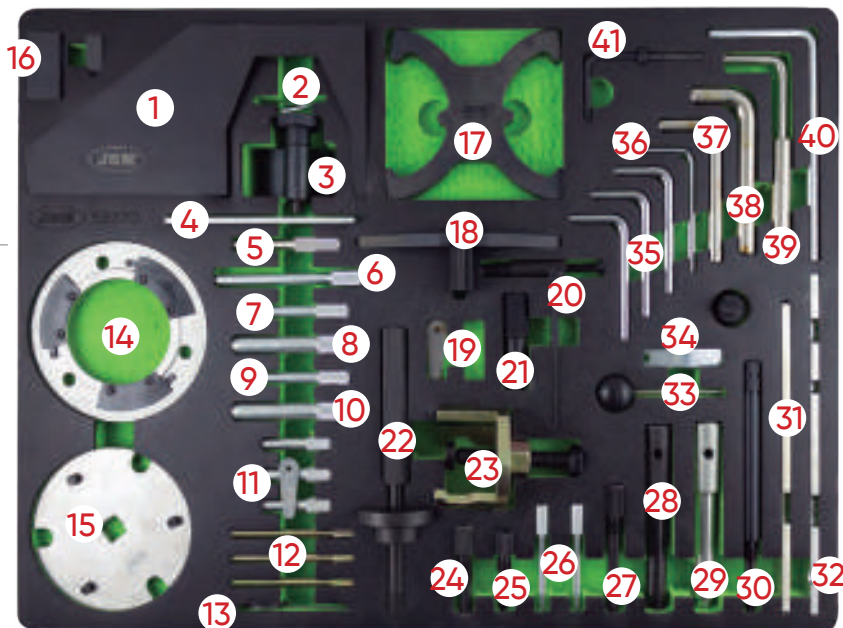

KIT DE CALADO OPEL / CHEVROLET / SAAB / FIAT / LANCIA / SUZUKI / FORD

53774 190,00€



GASOLINA/PETROL

GASOIL/DIESEL

MARCAS	ALFA: 145, 146, 147, 156, 159, 166, GT, Crosswagon Q4 FIAT: Punto, Grande Punto, Bravo, Brava, Marea Weekend, Stilo, Doblo, Cargo, Multipla Idea, Panda LANCIA: Ypsilon, Musa, Lybra, Thesis OPEL: Corsa B/C, Combo, Tigra, Agila, Tigra B, Meriva, Astra F/G/H, Astravan, Speedster VX220, Zafira A/B, Vectra B/C, Signum, Omega B, Sintra, Frontera A/B, Astravan, Kadett, Ascona, Omega, Monterey, Antara, Cromax, Speedster VX220 SUZUKI: Ignis, Swift, Wagon R+ FORD: Ka CHEVROLET & DAEWOO: Epica, Captiva, Nubira, Lacetti, Evanda SAAB: 9-3, 9-5 (98-04)
HERRAMIENTAS OEM	1860905000 / 1860905010 / EN-46788 (1), KM-6148 (2), KM-6148 (3), 1870900400 / 1871000200 (4), KM-954 (5), KM-J-43651 (6), 1860905000 / 1860905010 / EN-46788 (7), KM-852 (8), KM-853 (9), 1870900300 / 303-1468 (10), EN-46785 / KM-951 (11), KM-932 (12), 1860703000 (13), KM-955 (14), KM-6130 / KM-6349 / KM-6349 (15), KM-927 (16), EN-48245 (17), KM-933 (18), EN-46785 (19), 1860985000 / 1871000900 / EN-46781 (20), 1860985000 / 1871000900 / EN-46781 (21), EN-48246 (22), KM-929 (23), 1870896900 / EN-46789 (24), KM-952 (25), 21-162B / 303-376 / 303-376B (26), KM-933 (27)
CÓDIGOS DE MOTOR	X14XE, Z14XE, X16SEJ, X16XE, X16XEL, Y16XE, Z16XE, Z16YNG, C18XEL, X18XE, X18XE1, Z18XE, Z18XEL, C20SEL, C20XE, X20XEV, Z20LEH, Z20LEL, Z20LER, Z20LET, X22SE, X22XE, Y22SE, Y22XE, Z22XE, D223L, X10XE, Z10XE, Z10XEP, X12XE, Z12XE, Z14XEP, X20DTL, X20DTH, X22DTH, Y20DTL, Y20DTH, Y22DTH, Y22DTR, 169A1.000, 955A4.000, 350A3.000, 192B4.000, 198A2.000, 350A2.000, 955A3.000, 192A8.000, 198A6.000, 198A3.000, 199B1.000, 199B2.000, 199A2.000, 199A3.000, 199A9.000, 940A3.000, 188A3.000, 939A2.000, 188B2.000, 188A8.000, 188A9.000, 323.02, 371.01, 937A2.000, 182B4.000, 182B9.000, 188A2.000, 188A7.000, 192A9.000, 186A6.000, 186A8.000, 192A1.000, 192A3.000, 192A5.000, 192B1.000, 192A5.000, 186A9.000, 939A1.000, 199A5.000, 223A7.000, 223A9.000, 342.02, 362.02, 841G.000, 841H.000, 841P.000, 939A3.000, 185A2.000, 185A6.000, Z13DT, Z13DTJ, Z13DTH, Z19DT, Z19DTH, Z19DTJ, Z19DTL, X10XE, Z10XE, Z10XEP, Z12XE, Z14XEP, X16SZR, Z16SE, 4EC1/T, 4EC1, 4EE1/T, 4EE1, X17DT, Y17DT, Y17DTI, Y17DTL, 16DA, 17D, 17DR/X, 7DTL, X17DTL, 4JX1/4, JG2T, 4FC1/T, 4FD1, X20DTL, Y20DTL, D223L Z20DMH, Z20DM, RA420, Z20S1, 194A1.000, Z22SE, Z22YH

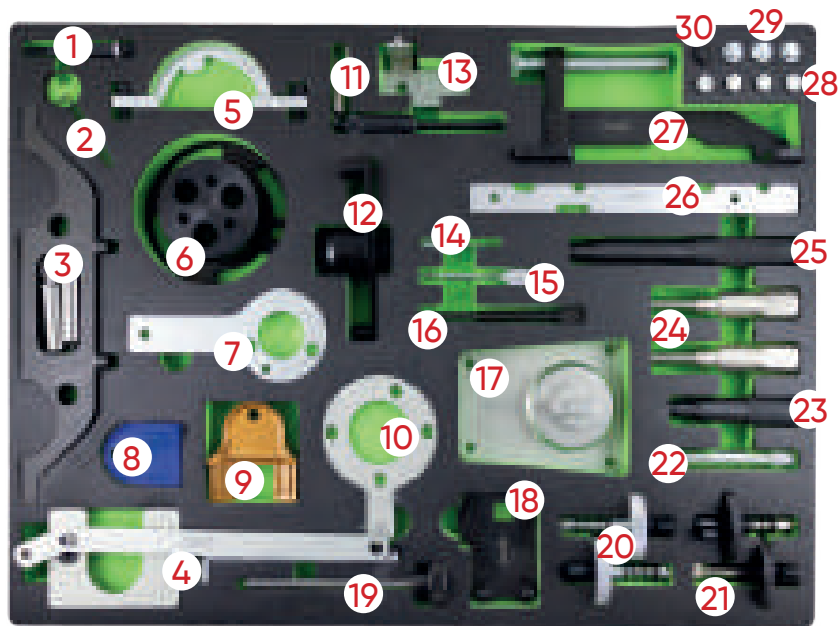

KIT DE CALADO FIAT / FORD / CITROËN / PEUGEOT

53771 158,00€

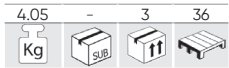

GASOLINA/PETROL

GASOIL/DIESEL

MARCAS	<p>FIAT: Ulysse, Scudo, Ducato LANCIA: Zeta, Phedra FORD: Fiesta, Fusion, Focus, Focus C-Max CITROËN: C15, C1, C2, C3 Pluriel, C4, C4 Picasso, C5, C6, C8, DS3, DS4, DS5, Xantia, Xsara, Xsara Picasso, Evasion, Berlingo, Jumpy, Jumper, Saxo, ZX, XM, Evasion, AX PEUGEOT: 107, 1007, 206 cc, 207, 208, 306, 307 cc, 308, 406, 407, 508, 607, 806, 807, Partner, Expert, Boxer, 206, 106, 605, 205, 405</p>
HERRAMIENTAS OEM	<p>4200-TH (1), 0117-AR (2), 0188-X (3), 0606-A1A2 (4), 0188-Q2 (5), 0189-S1 (6), 7017-TR (7), 0132-P / 4507-TL (8), 0189-C (9), 0188-J1 (10), 0188-J2 (11), 0178-E (12), 0189-R (13), 0132-AK / 0188-AK / 0189-K / 0153-AK / 4533-TAD / MOT 1436 (14), 0188-AH (15), 0189-S2 (16), 0153-AB / 9041-TZ (17), 0153-M / 0178-C / 0178-D / 7014-TM / 9767-94 (18), 0189-A (19), 4527-TS1 (20), 0153-AB / 9041-TZ (21), 0189-B / 21-163 (22), 0132-AJ1 / 0153-G / 0188-M / 0189-J / 4533-TAC1 / 5711-TA (24), 0189-L (25), 0188-D / 7017-TM (26), 0132-X / 0188-Q1 / 4507-TJ / 9767-89 (27), 0194-B (28), 0132-AB / 0194-A (29), 0194-C / 21-262 / 303-734 (30), 4527-TS2 (31), 0188-E (32), 0153-A / 6012-T / 9765-54 (33), 0134-AF / 0134-Q / 0188-F / 9004-T (34), 0188-P2 / 0188-P / 174 / 7015-T (35), 0153-U 7019-T (36), 0153-N / 0188-Y / 7014-TJ / 7099-TM / 9797-34 (37)</p>

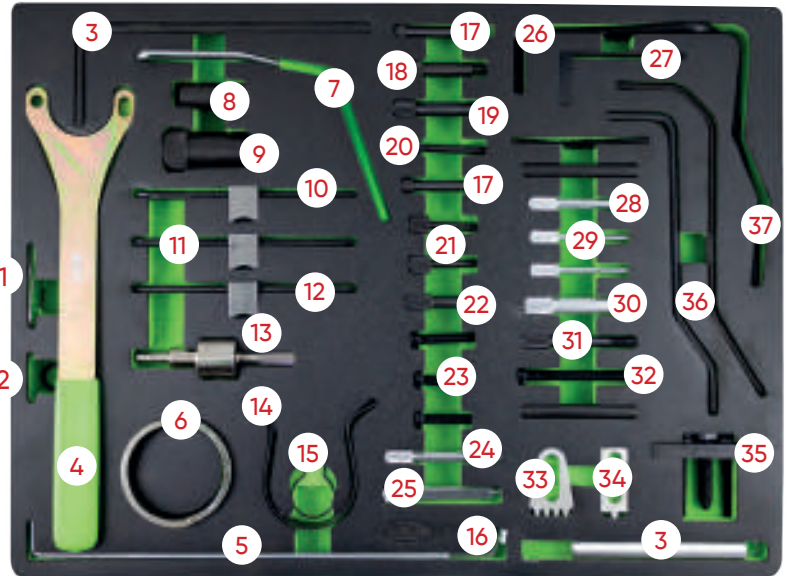

CÓDIGOS DE MOTOR	<p>F6JA, F6JB, F6JC, G8DA, G8DB, HHDA, HHDB, HHJA, HHJB Citroën_Peugeot: 1.0 / 1.1 / 1.4 / 1.6 / 1.6 16V, 1.4 / 1.6HDI / 1.8 / 1.8 16V / 2.0 / 2.0 Turbo, 1.9D / 2.0HDI / 2.2HDI / 1.8 16V / 2.0 16V TU9 (CDY/CDZ), TU1 (HDY/HDZ/HFX/HFY/HFZ), TU3 (KDX/KDY/KDZ/KFX/KFZ), TU5JP4 (NFU/NFX), TU5 (BDY/BFZ/NFT/NFV/NFW/NFY/NFZ), XU7 (LFW/LFX/LFZ), EW7J4 (RLZ), XU7JP4 (LGY), XU10 (RFL/RFU/RFV/RFX/RGX/RGY), XU10JP4 (RGX/RGY), EW10A (RFJ), EW10D (RLZ), EW12J4 (3FZ), ET3JE (KFU), TU3A/JP (KFW/KFX), DV4TD (8HW/8HX/8HZ), DV4TED4 (8HV/8HY), DV6ATED4 (9HX/9HY/9HZ), EW10-CVI (RLZ), EW12 (3FZ), DW8 (WJZ/WJY), DW10 (RHY/RHV/RHZ/RHS/RHM/RHW/RHT/RHR/RHX), DW12 (4HX/4HZ/4HW/4HY), EW7J4 (6FZ), EW10J4 (RFR), EW10J4D (RLZ), DW12TED4 (4HW), DW10ATED (RHT/RHV/RHW/RHX/RHZ) Ford 1.4 / 1.6 Duratorq TDCI</p>
-------------------------	---

KIT DE CALADO FORD / VAG / MAZDA / VOLVO

53772 229,00€

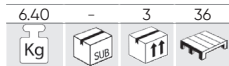

GASOLINA/PETROL

GASOIL/DIESEL

MARCAS	<p>ALDI: 80, A1, A2, A3, S3, A4, A5, A6, TT, Q5 SEAT: Arosa, Ibiza, Cardoba, Leon, Toledo, Alhambra, Altea, Inca (99-04) SKODA: Fabia, Octavia, Superb VW: Lupo, Polo, Fox, Golf, Bora, Jetta, Golf Plus, Passat, Beetle, Touran, Sharan, Caddy, Caddy Maxi, Transporter, Golf VI Cabrio, Tiguan FORD: Galaxy</p>
HERRAMIENTAS OEM	<p>T10252 (1), VAS6079 (2), T10121 (3), MPI-1312 / T10098 / T20038 / T20038 (4), T10123 (5), 23-058 / 310-084 / T10008 (6), 2065A / T10008 / U40021 (7), 3418 (8), T10171 (9), 23-059 / 23-059 / 310-085 / T10050 / T10050 (10), 3458 / T30094 (11), T10016 / T10074 / T10074 (12), T10100 (14), T10414 (15), 3366 / T20018 / T20044 (16), 3411 (17), 3369 / T30092 (18), T10341 (19), 3242 / T40069 / T30052 (20), T 40026 (21), 3359 / MPI-301 / T20102 (22), 2064 / U20003 (23), T10120 (24), MPI-1312 / T10098 / T20038 (25), T10170 (26), T00115 / T10264 / T40098 (27), T10092 (28), T00115 / T10264 / T40098 (29), 303-1054 / T10115 (30), T10060 / T10060A (31), 3359 / MPI-301 / T20102 (32), T10340 (33), 2587 (34), 3387 / U30009A (35), 3387 / T10020 (36)</p>

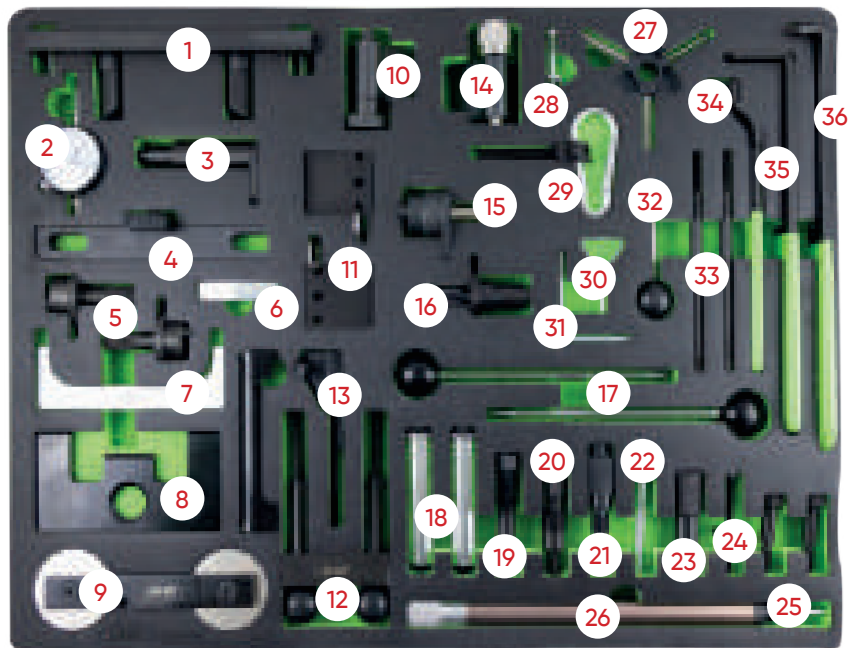

CÓDIGOS DE MOTOR	<p>ARC, ATN, AUS, AVY, AZD, AFH, BCA, AJV, AKQ, AUA, AUB, AXP, AFH, AFN, AFK, AHW, AHU, APE, AQQ, AUS, AXP, AZD, BBY, BBZ, BCB, ANY, AYZ, AMF, ATL, BAY, BHC, BMS, BNM, BNV, BWB, AJM, AMG, ANU, ARL, ASZ, ATD, ATJ, AUY, AVB, AVF, AVQ, AWX, AXB, AXC, AXR, BEW, BJB, BKC, BKE, BLS, BLT, BMT, BPX, BRB, BRM, BRR, BRB, BRU, BSU, BSW, BTB, BUK, BVK, BXF, BZF, AZV, BDJ, BDK, BGW, BHW, BKD, BKP, BLB, BMA, BMM, BMN, BMP, BMR, BNA, BPW, BRC, BRE, BRF, BRT, BUZ, BE, BVF, BVG, BVH, BVK, BVS, BMY, BLF, BVW, AVZ, BKD, AWY, AZQ (55 - 64 PF), AXU, BAG, BKG, BLF, BLN, BLP, BFV, BKF, BNU, BVP, BVR, IZ, CBZA, CBZC, CBZB, CAXA, CAGA, CAGB, CAGC, CAHA, CAYA, CAYB, CAYC, CBAA, CBAB, CBAC, CBBA, CBBB, CBDA, CBDB, CBDC, CBEA, CEGA, CKUB, AZV, BDJ, BHP, BKD, BLB, BMA, BMM, BMN, BMP, BMR, BNA, BPW, BRC, BRE, BRF, BRT, BSS, BUY, BUZ, BVA, BVE, BVF, BVG, BVH, BVW, ACV, ACV, AFB, AGX, AHD, AHY, AHY, AJT, AKE, ANJ, APA, AUF, AXG, AXG, AXL, AYC, AYM, AYY, BAU, BBE, BBF, BCZ, BDG, BDH, BFC, BJJ, BJK, BJL, BJM</p>
-------------------------	---



KIT DE CALADO VOLVO 3.0 , 3.2T6 FREELANDER2 3.2I

53315 285,00€

GASOLINA/PETROL

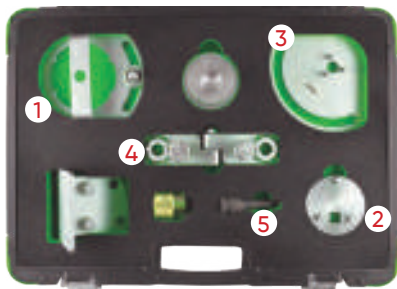
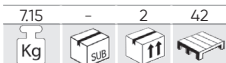

MARCAS	<u>VOLVO</u> : S60 (10-16), S80 (07-15), XC60 (08-15), XC70 (06-15), XC90 (10-14), V60 (10-15), V70 (10-15). <u>LAND ROVER</u> : Freelander II (11-14).
HERRAMIENTAS OEM	<u>VOLVO</u> : 999-7263 (3), 999-7264 (1), 999-7272 (5), 999-7257 (2), 999-7261 (4). <u>LAND ROVER</u> : 303-1225 (3), 303-1226 (1), 303-1219 (2), 303-1223 (4).
CÓDIGOS DE MOTOR	3.0 Turbo: B6304T2, B6304T4. 3.2: B6324S, B6324S5. 3.2i6: B6324S.

SET EXTRACTOR PARA POLEA O PIÑÓN DE LA BOMBA DE ALTA PRESION PARA HYUNDAI / KIA

54226 71,00€

GASOIL/DIESEL



MARCAS	<u>HYUNDAI</u> : Accent (11-15), Elantra (07-10), i20 (09-18), ix20 (10-18), i20 Coupe (15-17), i30 (07-19), ix35 (10-16), i40 (11-18). <u>KIA</u> : Carens (13-18), Ceed (07-18), Optima (11-15), Pro-Ceed (08-19), Rio (09-17), Cerato (05-07), Soul (09-14), Sportage (10-18), Venga (09-18).
HERRAMIENTAS OEM	09331-2A000/2A010 (1), 09331-2A010 (1)
CÓDIGOS DE MOTOR	1.1D CRDi: D3FF 1.4D CRDi: D4FC(U1), D4FC(U2) 1.6D CRDi: D4FB(U1), D4FB(U2), D4FB-H(U1), D4FB-H(U2), D4FB-L(U1) 1.7D CRDi: D4FD(U2), D4FD-H(U2), D4FD-L, D4FD-L(U2)

KIT DE CALADO PORSCHE

54200 56,00€

GASOLINA/PETROL



MARCAS	911 (2001 - 2008), Boxster (2002 - 2011), Cayman (2006 - 2009)
HERRAMIENTAS OEM	9685 (1), 9686 (2), 9595 (3), 9595/1 (4)
CÓDIGOS DE MOTOR	M96/03, M96/05, M96/23, M96/25, M97/20, M96/24, M96/26, M97/01, M97/21, M97/22.



CONJUNTO DE 6 MÓDULOS DE KITS DE CALADO

53775 1.109,00€

GASOLINA/PETROL

GASOIL/DIESEL



53769 RENAULT / NISSAN / OPEL / VOLVO



53770 FORD / SEAT / VOLKSWAGEN / MAZDA / VOLVO



53771 FIAT / FORD / CITROËN / PEUGEOT



53772 FORD / VAG / MAZDA / VOLVO



53773 FIAT / ALFA / LANCIA / OPEL / SUZUKI / FORD



53774 OPEL / CHEVROLET / SAAB / FIAT / LANCIA / SUZUKI / FORD



CARRO DE HERRAMIENTAS 7 CAJONES ESPECIAL KITS DE CALADO

53951 1.794,00€

94.70 Kg 1 SUB 1 4

53952 1.794,00€

94.70 Kg 1 SUB 1 4

53775 1.109,00€

GASOLINA / PETROL GASOIL / DIESEL



SET DE 6 MÓDULOS DE KITS DE CALADO

53772 53773 53774

53769 53770 53771

LLAVE UNIVERSAL PARA ÁRBOL DE LEVAS + ADAPTADORES

51340 39,30€

2.15 Kg 6 SUB 180



- Contiene:
1 Llave con rango de apertura: 40mm mín - 235mm máx. + Largo 540mm.
4 juegos de 2 tornillos adaptadores de 4 medidas.
1 juego de 2 roscas de 1cm. de diámetro.



EXTRACTOR DE POLEA DE ÁRBOL DE LEVAS FORD

53318 24,00€

0.40 Kg 20 SUB



MARCAS	FORD
APLICABLE A MOTORES	F8M, F8Q, S8U, S9U.

BLOQUEADOR DE CIGUEÑAL Y LEVAS PARA RENAULT / NISSAN / DACIA / SUZUKI

51488 16,00€

0.25 Kg 5 SUB 100 2300

- Pasadores de seguridad para el conjunto de árbol de levas y el cigüeñal para Renault motores diesel y de gasolina.
- Conveniente para el bloqueo del motor durante el cambio o mantenimiento del conjunto del árbol de levas.

MARCAS	RENAULT: Captur, Clio II,III,IV, Espace/Grand Espace III,IV, Fluence, Kadjar, Kangoo, Laguna I,II,III, Logan/Logan MCV, Megane I,II,III,IV, Modus/Grand Modus, Scenic/Grand Scenic I,II,III,IV, Twing II, Trafic II, Master II 1.5dCi & 1.9 dCi. DACIA: Dokker, Duster, Lodgy, Logan, Sandero 1.5dCi NISSAN: Almera, Cube, Juke, Kubistar, Micra, Note, NV200/Evalia, Primera, Tiida, Interstar, Primastar 1.5dCi & 1.9 dCi SUZUKI: Grand Vitara, Jimny 1.5DDiS & 1.9DDiS
CÓDIGOS DE HERRAMIENTAS	MOT1489, MOT1430, MOT1054.
CÓDIGOS DE MOTOR	K9K, F8Q, F9Q - Gasolina, Clio, R19, Laguna 1.8/2.0 Motor de códigos: F3R F3P

ÚTIL DE CALADO DE DISTRIBUCIÓN VAG

52271 18,00€

0.45 Kg 10 SUB 40 800

MARCAS	AUDI: A2 1.4TDI (02-06), A3 1.9 2.0TDI (02-08), A4 1.6TDI (02-05), A4 1.9 2.0TDI (04-08), A6 1.9TDI (02-05). SEAT: Altea 1.9SDI/TDI (05-08), Leon 1.9 2.0TDI (05-08), Toledo 1.9SDI/TDI (05-08). SKODA: Fabia 1.4TDI (03-06), Octavia II 2.0TDI (03-06) VW: Beetle 1.9TDI (02-08), Bora 1.9TDI (02-08), Fox 1.4TDI (02-08), Golf 1.9 2.0TDI (02-08), Lupo 1.4TDI (02-08), Polo 1.4, 1.9TDI (02-08), Sharan 1.9TDI (02-08).
CÓDIGOS DE MOTOR	AUDI: AMF, ASZ, ATD, AVB, AVF, AWX, AXR, AZV, BHC, BKC, BKD, BKE, BLB, BMN, BNA, BPW, BRB, BR, BRD, BRE, BRF, BUY, BVA, BVF, BVG. SEAT: BJB, BKC, BLS, BMM, BXE SKODA: AMF, AZV, BKD VW: AJM, AMF, ANU, ARL, ASZ, ATD, AUJ, AVB, AVF, AWX, AXR, BAY, BMS, BNM, BNV, BWB

SET DE BLOQUEO DEL ÁRBOL DE LEVAS

51489 12,00€

0.35 Kg 10 SUB 40 2250

GASOLINA / PETROL

- Motores de árbol de levas doble.

MARCAS	VW: Lupo 99, Polo 95, Caddy 96, Polo Classic, Variant 96, Beetle 1.4L 99, Golf 1.4L, 1.6L 98 y 1.4L, Bora, 1.6L 99. AUDI: A2.
HERRAMIENTAS OEM	T10016.
CÓDIGOS DE MOTOR	1.4 / 1.6 16V

HERRAMIENTA DE BLOQUEO DEL ÁRBOL DE LEVAS GRUPO VAG

53320 12,00€

GASOIL / DIESEL

MARCAS SEAT: Alhambra, Altea, Arosa, Cordoba, Ibiza, Leon, Toledo 1.4/1.9/2.0 TDI.
VW: Passat 1.9.
AUDI: A4/A6 1.9.

HERRAMIENTAS OEM T10008, T20102, T10100.

IVA no incluido

EXTRACTOR/INSTALADOR DE RETENES DE CIGÜEÑAL (GRUPO VAG)

53875 134,00€

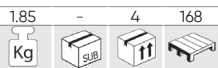

MARCAS	VW: Golf, Touran AUDI: A3, A4
HERRAMIENTAS OEM	OEM T10134.
CÓDIGOS DE MOTOR	1.4i turbo 1.4, 1.6 inyección directa de gasolina 1.9, 2.0 SDI 2.0 diesel common rail

DESMONTADOR Y TENSOR DE CORREAS EN POLY-V

51927 25,00€

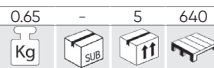

- Para montar-desmontar y extraer las nuevas correas en POLY-V fácilmente.
- Adecuado para el PSA y los motores de Ford Fiesta 1.4/1.6, Citroën C4, Peugeot 307, Fiat Doblo, Dacia Logan.
- Herramienta indispensable para uso profesional.
- Sin un punto de agarre preciso, no es posible desmontar y extraer las correas adecuadas para este utillaje.



TENSIÓMETRO PARA CORREAS DE DISTRIBUCIÓN

52616 44,00€

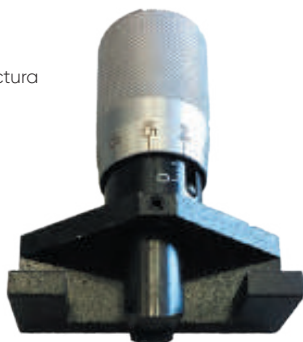
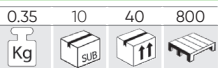

- Dos escalas graduables (daN) con lectura frontal y posterior.

HERRAMIENTA DE SINCRONIZACIÓN DE POLEAS VW / AUDI 2.5TDI 35MM

53325 7,50€

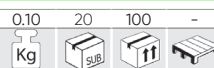

GASOLINA/PETROL



MARCAS	AUDI: 100 ('91-), A6 (2.5 TDI) 2.3, 2.4, 2.5, 2.8, 2.9D TDI (1991-2003) VW: LT, Transporter
HERRAMIENTAS OEM	3355

CÓDIGOS DE MOTOR	AAB, AAT, ACU, ACV, AEL, AET, AGX, AHG, AHY, AJA, AJT, ANJ, APA, APL, AUF, AVT, AXG, AXL, AYC.
-------------------------	--

HERRAMIENTA AJUSTE TENSIÓN CORREA VAG

53321 10,50€

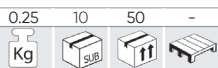

GASOLINA/PETROL

MARCAS	AUDI: A4/1.8T/2.0 1999-2004 A6/1.8T 2002-2004 A4/3.0 (2002 -), A6/3.0 (2002 -), A8/7.0 (2003 -). VW: Golf Passat 2.0 TDI DIESEL, Golf 88-97, Passat 92-97, VW T4/2.0 1992-2004.
HERRAMIENTAS OEM	T10020.



HERRAMIENTA RETENCIÓN BOMBA ANTICONGELANTE OPEL / VAUXHALL 2,2

53317 34,00€



GASOIL/DIESEL



- Utilizado para dejar el motor en posición alineada durante la sustitución de la bomba de agua.
- Permite reemplazar la bomba sin modificar la posición de la cadena de distribución.

MARCAS	OPEL 2.2 Cadena VAUXHALL 2.2 Cadena
---------------	--

VASO DE 1/2" PARA LA TUERCA DE RETENCIÓN DE LA ANTECÁMARA DE COMBUSTIÓN

52819 22,00€

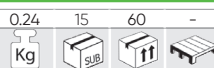

1/2" MERCEDES

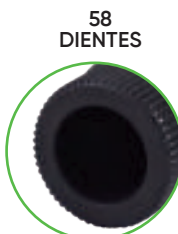

58 DIENTES





ACCESORIOS LUBRICANTES

- 248 CUBETOS PARA BIDONES
- 250 BOMBAS SUMINISTRO GASOIL
- 251 BOMBA DE UREA AUS32
- 252 BOMBAS EXTRACCIÓN / LLENADO DE ACEITE
- 253 RECOGEDORES DE ACEITE
- 256 PISTOLAS DE SUCCIÓN
- 258 VARIOS / EMBUDOS

CUBETO RETENCIÓN PARA BIDONES

Cubierta desmontable / Palet fijo para derrames / Quitar los bidones antes de utilizar una carretilla elevadora / Fácil transporte / Para usar con la mayoría de carretillas elevadoras y transpalets / Fabricado en polietileno (PE) 100% reciclable.

SOPORTA 400 KG

52804 343,00€

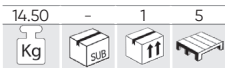

230L

1 BIDÓN VERTICAL

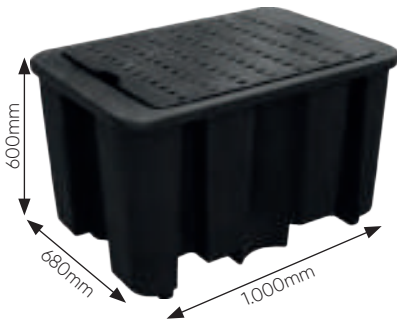

SOPORTA 650 KG

52805 426,00€

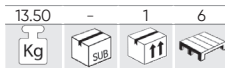

250L

2 BIDONES VERTICALES

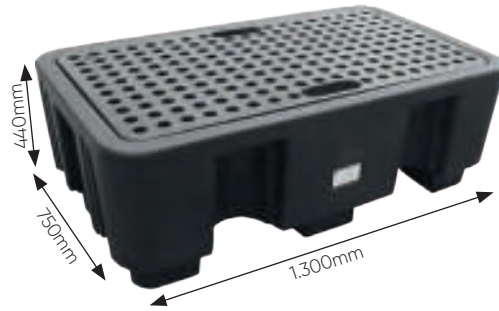

NO APTO PARA TRANSPALETAS
SOPORTA 1.250 KG

52806 742,00€

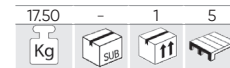

250L

4 BIDONES VERTICALES

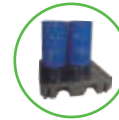

HOMOLOGADO DIBT

CUBETO RETENCIÓN ESPECIAL EUROPALET 2 BIDONES

53214 285,00€

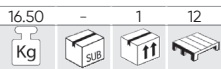

- Para 2 bidones.
- Compatible con europallet (1200 mm x 800 mm) y paletas plásticas con dimensiones similares.
- Apilable para el transporte y el almacenaje económico.
- Se puede colocar la europallet directamente encima del cubeto para reducir el coste.
- Las paletas cargadas pueden ser colocadas en/ retiradas del cubeto con o sin la rejilla por carretilla elevadora.
- Cubeto con una altura baja idóneo para el trabajo.
- Capacidad en línea o por encima de las normas Europeas, Británicas y Americanas.
- Puede ser manipulado por carretilla elevadora de los 4 lados o transpaleta por 2 lados cuando está vacío.
- Fabricado en polietileno - 100% reciclable.

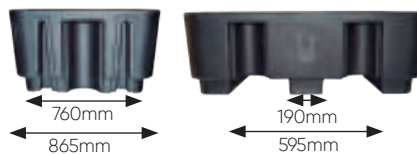

CUBETO RETENCIÓN 1 CONTAINER IBC 1.000L

52807 1.714,00€

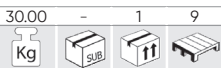

- Apilable, ahorra espacio, innovador.
- Altura baja (700mm) para facilitar su uso.
- Superficie de trabajo muy amplia (2,5 m²).
- Plataforma con acceso para las manos y agujeros para inspección y para inserción de bombas.
- Fácil transporte.
- Compatible con la mayoría de carretillas elevadoras y transpaletas.
- PE 100% reciclable resistente a los rayos UV.

SOPORTA 2.500 KG



HOMOLOGADO DIBT

BIDÓN METÁLICO

54181 25,10€

1.45	-	4	72
Kg	sub	ff	ff

5L

55x26x35cm

54182 34,70€

2.55	-	4	48
Kg	sub	ff	ff

10L

57x35x42.5cm

54184 44,00€

4.10	-	4	24
Kg	sub	ff	ff

20L

76x37x50cm



54183 38,20€

2.75	1	6	48
Kg	sub	ff	ff

54x39x58cm

10L



cumple con el certificado

ANTI VUELCO



BOQUILLA FLEXIBLE PARA BIDÓN METÁLICO
(REF.54181, 54182, 54183, 54184)

15874

6,50€

0.30	50	800
Kg	sub	ff

CARRO PORTA BIDONES ESPECIAL ENGRASE PINZA PARA BIDONES (CAPACIDAD 500KG.)

50924 342,00€

- Apto para bidones de aceite de 200L.

31.00	-	1	6
Kg	sub	ff	ff



RUEDA GIRATORIA

53612 96,00€

4.75	-	1	66
Kg	sub	ff	ff

500Kg

- Para manejar bidones de aceite.
- Capacidad: 500kg.
- Tipo vertical de agarre del bidón.
- Especial bidones aceite 200L.



CE

LLAVE PLÁSTICA PARA BIDÓN

52452 8,00€

0.12	6	60	1080
Kg	sub	ff	ff

- Material: Nylon.
- Antichispa y antipolvo.
- Relieves acabado de 3/4" y 2".
- Útil para bidones de 200L.

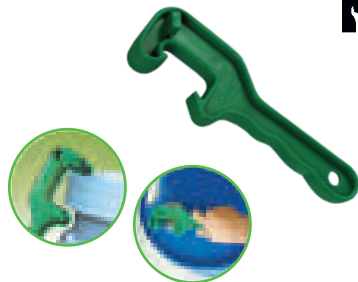

GRIFO PARA BIDONES DE 200L

53078 18,00€

0.25	5	25	300
Kg	sub	ff	ff

- Permite un vaciado rápido de bidones de 200L.
- Puede ser usado para agua, todo tipo de aceites y alcohol.
- Material: polietileno (PE).
- Junta en E PDM.
- Resorte en acero inoxidable.



GRIFO PLÁSTICO PARA BIDÓN DE ACEITE 3/4"

53518 3,50€

0.05	10	500	3000
Kg	sub	ff	ff

- Válido para todos los líquidos.
- Rosca macho 3/4".



200L

GRIFO PARA BIDÓN ACEITE DE 3/4"

52453 21,00€

0.19	5	100	1000
Kg	sub	ff	ff

- Grifo de seguridad.
- Rosca de 3/4".
- Cuerpo de Aleación.
- Junta de Nylon.
- Aplicaciones: aceites, lubricantes, gasolina, diesel, queroseno, etc.
- Válido para Urea AUS32.



200L

BOMBA SUMINISTRO GASOIL CON PISTOLA Y CONTADOR (200V-240V)

53697 398,00€

17,00	-	1	18
Kg	sub	ff	

- Voltaje: 220V±10% 50HZ.
- Potencia: 550W.
- Caudal de entrega: 20-65 l/min.

- Longitud cable: 2m.
- Longitud manguera de succión: 2m.
- Longitud manguera de suministro: 4m.

CON PARO AUTOMÁTICO



200V	550W	50Hz
240V		
2m	4m	20-65 l/min



BOMBA

15981	8,75	-	2
181,00€	Kg	sub	ff



PISTOLA

15980	1,20	20
55,00€	Kg	ff



CONTADOR DIESEL/ GASOLINA

15982	1,85	8
73,00€	Kg	ff



MANGUERA PARA SUMINISTRO

15984	0,60	-
48,00€	Kg	ff



MANGUERA PARA EXTRACCION

15983	0,60	10
11,50€	Kg	ff

BOMBAS DE SUMINISTRO DE GASOIL CON PISTOLA

- Bombas de transferencia de combustible **portátil**.
- **Fácil de transportar**: tamaño compacto y con asa incorporada.
- Pistolas con **apagado automático**.

BOMBA SUMINISTRO GASOIL CON PISTOLA (230V)

53610 294,00€

13,00	-	1	24
Kg	sub	ff	

CON PARO AUTOMÁTICO

- Eléctrica.
- Se suministra con pistola y mangueras.



230V	10A	2800 RPM	60L/min
550W			
2m	4m	Manguera para extracción de combustible (2m)	

BOMBA

15981	8,75	2
181,00€	Kg	ff

PISTOLA

15980	1,20	20
55,00€	Kg	ff

MANGUERA PARA EXTRACCION

15983	0,60	10
11,50€	Kg	ff

MANGUERA PARA SUMINISTRO

15984	0,60	-
48,00€	Kg	ff

BOMBA SUMINISTRO GASOIL CON PISTOLA (12V)

53609 190,00€

7,30	-	1	24
Kg	sub	ff	

CON PARO AUTOMÁTICO

- Longitud de la manguera de entrada: 2m.
- Longitud de la manguera de salida: 4m.

12V	10A	3600 RPM	45L/min
175W			
2m	4m	Manguera para extracción de combustible (2m)	

BOMBA

15553	3,35	1
108,00€	Kg	ff

PISTOLA

15980	1,20	20
55,00€	Kg	ff

MANGUERA PARA EXTRACCION

15983	0,60	10
11,50€	Kg	ff

MANGUERA PARA SUMINISTRO

15984	0,60	-
48,00€	Kg	ff

BOMBA ELÉCTRICA PARA DIESEL

54100 265,00€

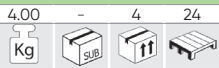

Longitud tubo de succión: 850-1245mm
 Longitud manguera: 2m
 Temperatura de trabajo: 5° - 40°C (41° a 104°F)
 Voltaje Corriente continua: 12V
 Corriente alterna: 100-240V Longitud cable: 4m
 Capacidad de bombeo: 18.4LPM (4.86GPM)
 Viscosidad máxima del fluido: 100 CST



PISTOLA AUTOMÁTICA PARA SUMINISTRO UREA AUS32

15631 98,00€

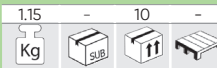

DEPÓSITO PARA UREA AUS32 (75L)

53644 1.238,00€

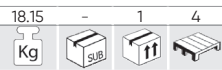

- Tanque de 75 litros móvil con una potente bomba de 12V capaz de suministrar hasta 10l/min, manguera y válvula de cierre automático.
 - Las ruedas de gran diámetro (20mm) permiten maniobrar fácilmente en terrenos irregulares.



FABRICADO EN POLIETILENO
 RESISTENTE A LOS GOLPES, A LA CORROSIÓN Y A LOS RAYOS UV



POTENTE BOMBA DE 12V CAPAZ DE SUMINISTRAR 10 L/MIN



CABLE DE 4M
 MANGUERA DE EPDM DE 4M

BOMBA ELÉCTRICA PARA UREA AUS32

53645 268,00€



- Bomba eléctrica para bidones diseñada para medios a base de agua, Urea AUS32 y productos químicos selectos de bidones metálicos de 205L o 1000-1250L de IBCs.
 - Construcción compacta y ligera.
 - Fusible incorporado para protección de sobrecarga y motor silencioso.
 - Filtro de acero inoxidable integrado en la entrada del tubo de succión que evita que los contaminantes entren y causen daños.



INTERRUPTOR ON/OFF CON INDICADOR LED



ADAPTADOR + CONVERTIDOR INCLUIDOS

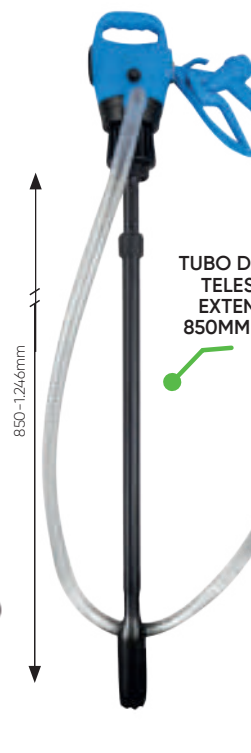

TUBO DE SUCCIÓN TELESCÓPICO EXTENSIBLE DE 850MM A 1.245MM



PISTOLA

15123 32,00€

MANGUERA 4M

14473 46,00€

ADAPTADOR DE ENTRADA PARA DEPÓSITO IBC

14703 13,00€

30mm

187mm

187mm

2" BSP



IVA no incluido

JBM / www.jbmcamp.com

251

BOMBA PARA BIDÓN DE ACEITE + MANGUERA CON GRIFO

52601 397,00€

200L



- Presión Ratio: 5:1.
- Entrada de Aire: 1/4".
- Salida de Aire: 1/4".
- Presión trabajo: 6-8 bar.
- Presión Máx.: 8 bar.
- Consumo de Aire: 250 L/min.
- Capacidad relativa 6 bar: 18 L/min.
- Temperatura del aceite: -10~50°C.
- Viscosidad máxima: 240 SAE.
- Largo del tubo: 950mm.



MANGUERA CON GRIFO PARA REF. 52601

12056 57,00€



- ## KIT DE BOMBA ACEITE + MANGUERA + PISTOLA ACEITE DIGITAL
- 50935** 595,00€
- 200L**
-
- Largo de la manguera: 2m.
 - Largo del tubo: 950mm.
 - Viscosidad máxima: 240 SAE.
 - Capacidad relativa 6 bar: 18 L/min.
 - Consumo de aire: 250 L/min.
 - Temperatura del aceite: -10~50°C.
 - Presión trabajo: 6- 8 bar.
 - Presión Ratio: 5:1.
 - Entrada de Aire: 1/4".
 - Salida de Aire: 1/2".
 - Presión Máx.: 8 bar.

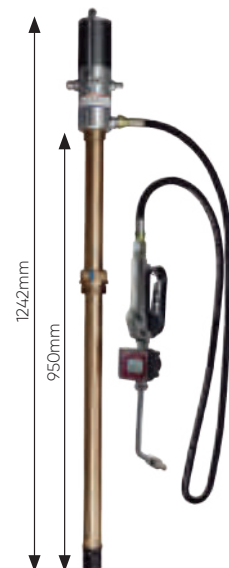

- ## BOMBA PARA BIDÓN DE ACEITE
- 50918** 341,00€
- 200L**
-
- Presión Ratio: 5:1.
 - Entrada de Aire: 1/4".
 - Salida de Aire: 1/2".
 - Presión trabajo: 6 - 8 bar.
 - Presión Máx.: 8 bar.
 - Consumo de Aire: 250 L/min.
 - Capacidad relativa 6 bar: 18 L/min.
 - Temperatura del aceite: -10~50°C.
 - Viscosidad máxima: 240 SAE.
 - Largo del tubo: 950mm.

TUERCA DE BIDÓN PARA REF. 50935 Y 50918



10767 21,00€



10925 18,00€

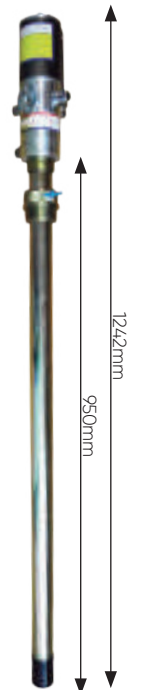

PISTOLA DE BOMBEO PARA ACEITE CON CONTADOR DIGITAL

50917 271,00€

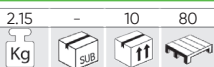

PILA PARA REF. 50917

10000 7,00€



- Entrada: 1/2".
- Rango de Caudal: 1-35 L/min.
- Presión trabajo: 6 - 8 bar.
- Rango de temperatura del aceite: -10~60°C.
- Viscosidad máxima: 240 SAE.
- Pila incluida.
- Peso: 1,4Kg.

ADAPTADOR ROSCA BOMBA-BIDÓN PLÁSTICO

13982 4,00€

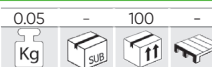

- Permite ajustar y compensar las diferentes roscas de bidones, bombas y barriles.



BOMBA MANUAL DE EXTRACCIÓN

52428 43,00€

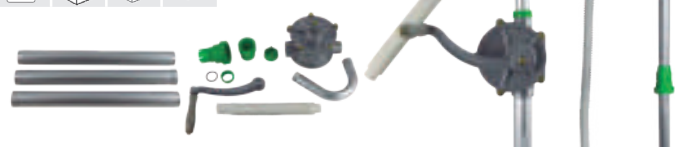

- Para bidones entre 50 y 200L.
- Caudal: 400ml por impulso.
- Capacidad de bombeo: 32L x min.
- Adaptador de boca de 2" incluido.
- Tubería de succión de 101cm, con entrada de 1 1/4" y salida de 1".
- Aplicaciones: aceites, lubricantes, diésel, fluidos a base de petróleo.
- Recomendado para: líquido de freno, detergentes, glicerina, ácidos suaves, fluidos a base de petróleo.
- No permitido para: ácidos fuertes, lejías, gasolina.

BOMBA MANUAL PARA EXTRACCIÓN DE ACEITE

51253 41,00€

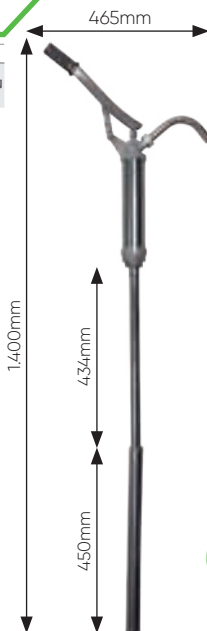

BOMBA MANUAL DE EXTRACCIÓN PLÁSTICA

52329 36,40€



- Para bidones de 25, 50 y 200L.
- 350ml por bombeo.
- Cuerpo y pistón de polipropileno.
- Mango de plástico ABS.
- Aplicaciones: Alcoholes, aceites, lubricantes, gasolina, diesel, queroseno, etc.
- Conducto de succión: Largo mínimo: 320mm. Largo máximo: 900mm.



RECOGEDOR DE ACEITE CON SISTEMA DE ASPIRACIÓN

53874 398,00€

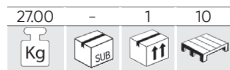

90L **8-10 BAR**

DESPIECE DISPONIBLE



Diseñado para recolectar y drenar aceite procedente del motor o caja de cambio del vehículo.

- Presión de trabajo: 8 ~ 10 bar.
- Presión de vacío: 0 ~ 0,8 bar negativo.
- Capacidad del depósito: 70L.
- Capacidad del embudo de recogida: 10L.
- Capacidad del vaso medidor: 10L.
- Velocidad de aspiración según diámetro de la varilla: 0,8L/min (Ø5x3,5mm); 1L/min (Ø6x4,5mm); 1,6 L/min (Ø8x6,5mm).
- Dimensiones: 43x49x163cm.
- Temperatura recomendada de trabajo del aceite: 40 ~ 60°C.
- Sistema de aspiración.
- Sistema de medición ocular.
- Depósito de gran capacidad.
- Mango para facilitar manipulación.
- Ruedas para facilitar el transporte.

REF.	CARACTERÍSTICAS	Kg	Sub	Box	Pallet	€
15018	Módulo EVA juego de vasos para tapones cárter 22pcs	1,45	-	10	480	46,00€
14937	Rueda para recogedor de aceite 80l	0,30	-	14	-	9,50€
15282	Manómetro	0,20	-	20	-	15,00€
15283	Manguera (Para depósito metálico)	0,40	-	20	-	27,50€
15305	Manguera con grifo en forma de gancho	0,65	-	40	-	19,50€
15306	Manguera para conectar el embudo al depósito con válvula de cierre	0,35	-	20	-	27,50€
15307	Embudo para recogedor de aceite	2,10	-	10	40	39,60€
15310	Grifo parte superior para recogedor de aceite	0,05	-	20	-	11,50€
15311	Racord	0,20	-	20	-	11,50€
15312	Racord para conectar el depósito y la manguera	0,10	5	40	-	11,50€
15318	Tubo de conexión para recogedor de aceite	0,80	-	20	-	17,00€
15308	Rueda pequeña giratoria	0,35	-	40	-	7,00€
14014	Manguera recambio de 4mm	0,02	-	150	1500	6,00€
14015	Manguera recambio de 6mm	0,05	-	150	2250	6,00€
14016	Manguera recambio de 8mm	0,05	-	100	-	6,00€
15550	Tubo metálico de succión de 6mm	0,05	-	100	-	6,00€
15551	Tubo metálico de succión de 8mm	0,05	-	100	-	6,00€



MÓDULO EVA JUEGO DE VASOS PARA TAPONES CÁRTER 22PCS

15018 46,00€

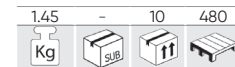

RECOGEDOR DE ACEITE POR GRAVEDAD

53873 285,00€



80L **1-3 BAR**

Diseñado para recolectar y drenar aceite procedente del motor y caja de cambio del vehículo.

- Vaciado
- Presión de trabajo: 1-3bar
- Capacidad del depósito: 70L
- Capacidad del embudo de recogida: 10L
- Dimensiones 35x48x163cm
- Tipo combustible: aceite de motor y de engranaje.
- Depósito de gran capacidad.
- Mango para facilitar la manipulación
- Ruedas para facilitar el transporte.

DESPIECE DISPONIBLE



REF.	CARACTERÍSTICAS	Kg	Sub	Box	Pallet	€
15018	Módulo eva juego de vasos para tapones cárter 22pcs	1,45	-	10	480	46,00€
14937	Rueda para recogedor de aceite 80l	0,30	-	14	-	9,50€
15305	Manguera con grifo en forma de gancho	0,65	-	40	-	19,50€
15307	Embudo para recogedor de aceite	2,10	-	10	40	39,60€
15309	Tubo de conexión para recogedor de aceite	0,75	-	20	-	17,00€
15312	Racord para conectar el depósito y la manguera	0,10	5	40	-	11,50€
15308	Rueda pequeña giratoria	0,35	-	40	-	7,00€



BOMBA DE ASPIRACIÓN DE ACEITE - 12V

53566 32,00€

1,00	5	10	210
Kg	sub	ff	

- Extractor de aceite, ideal para los cambios de aceite limpios y rápidos.
- Funciona conectando las pinzas a la batería de 12 voltios del coche.
- El aceite se sustrae del motor del vehículo a través del orificio de la varilla de medición de aceite.
- Se puede usar para extraer aceite de motor, aceite diesel o aceite de calefacción.
- Util también para trasvases generales de los líquidos indicados.

12V	70 dB(A)	5A
2.5(m/s)	MOTOR-OIL 1L/min	DIESEL-OIL 2L/min

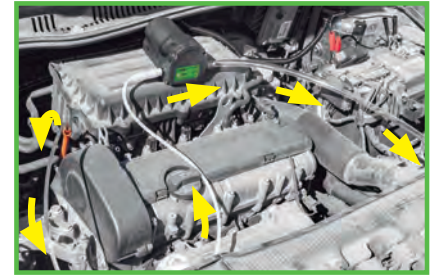

KIT EXTRACTOR DE ACEITE Y COMBUSTIBLE

53627 22,50€

0,55	-	12	96
Kg	sub	ff	

- Diseñado y fabricado para extraer fácilmente aceite, combustible, y fluidos de transmisión / diferenciales de las reservas de los generadores, máquinas de lavado a presión, compresores de aire, tractores para césped y jardín, o ATV's.



COMPROBADOR DE ANTICONGELANTE

53453 7,00€

0,10	24	96	384
Kg	sub	ff	

-43°C ~ 131°C



ALFOMBRA CON DEPÓSITO PARA LÍQUIDO DESINFECTANTE / ACEITE

53862 6,00€

1,45	-	5	100
Kg	sub	ff	

- Medidas: 85x55x10cm
- Material: TPE
- Capacidad máxima recomendada: 3L
- Capacidad máxima: 8L

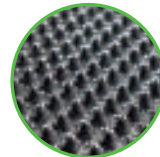

MOQUETA PARA SECADO

53863 3,00€

0,70	-	5	240
Kg	sub	ff	

- Medidas: 76x48cm
- Material: Poliéster

REFRACTÓMETRO PARA ALCOHOLES

50731 68,00€

0,56	-	5	500
Kg	sub	ff	



REFRACTÓMETRO UNIVERSAL

52963 49,00€

0,28	5	20	460
Kg	sub	ff	

- Etileno glicol: -50°C ~ -0°C.
- Propileno glicol: -50°C ~ -0°C.
- Líquido limpiaparabrisas: -40°C ~ -0°C.
- UREA AUS32: -30% ~ 35%.
- Líquido de batería: -1.100 - 1.400 sg/l.



UREA AUS32



MÁQUINA PARA CAMBIO DE ACEITE DE TRANSMISIÓN AUTOMÁTICA

54050 980,00€

Permite el cambio automático del aceite de transmisión.

25,45	-	1	4

- Fuente de alimentación: 12 V (batería de coche)
- Potencia de la bomba: 70 W
- Diámetro del manómetro de aceite: 70 mm (ambos manómetros)
- Rango del manómetro de aceite: 0-10 bar (0-150 psi) (ambos manómetros de aceite)
- Capacidad del depósito de aceite nuevo: 30 litros
- Capacidad del depósito de aceite usado: 30 litros

Incluye:

- 1 dispositivo de intercambio y lavado
- 1 juego de adaptadores con 37 adaptadores de conexión / adaptadores de manguera
- 1 manguera de conexión roja con acoplamiento rápido, longitud 250 mm, diámetro 12,5 mm (1/2"), máx. 20 bar (300 psi)
- 1 manguera de conexión negra con acoplamiento rápido, longitud 250 mm, diámetro 12,5 mm (1/2"), máx. 20 bar (300 psi)



Incluye maletín con adaptadores para diferentes marcas (Volkswagen, BMW, Land Rover, Ford, Mercedes, Buick).



PINZAS PARA BATERÍA DE 12V

SET DE ADAPTADORES PARA REF.54050

15539	1.30	5	
104,00€			

FILTRO

15542	0.10	20	
45,00€			

JUNTA TÓRICA PARA ENTRADA DE ACEITE (REF.54050)

15480	0.00	-	
0,99€			

KIT BOMBA LLENADO SISTEMA TRANSMISIÓN CON ADAPTADORES

52797 198,00€

5,00	-	1	24

- Capacidad: 75L.
- Descarga: 80cc ciclo.
- Rango de viscosidad: hasta SAE 140.
- Permite llenado y vaciado

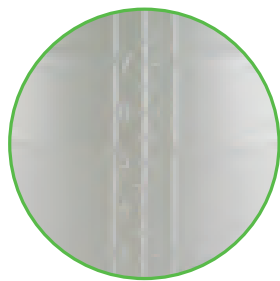

BOMBA LLENADO SISTEMA TRANSMISIÓN SIN ACCESORIOS PARA REF.52797

13234	3.75	1	24
224,50€			



SET DE ADAPTADORES PARA BOMBA DE LLENADO SISTEMA TRANSMISIÓN P/52797

12044 147,00€

1.32	-	20	120

101
FORD 1/8 - 27 (NPT)

102
UNIVERSAL, BMW, HONDA, NISSAN, etc

103
VW/AUDI, SKODA

104
VW/AUDI, PORSCHE

105
VW/AUDI, MINI COOPER M10x1.0

106
VW/AUDI DSG M24x1.5

107
VW/AUDI CVT M22x1.5

108
MERCEDES M12x1.5

109
VW/SKODA M18x1.5

110
AUDI/VW, SKODA, M30x1.5

111
UNIVERSAL FLEXIBLE 300mm, HONDA, HYUNDAI, KIA, etc.

112
VOLVO 5/16 - 24 (UNF)

113
TOYOTA, LEXUS M18x1.0

114
NISSAN, INFINITY M8x1.0

115
ATF - ADAPTER VW PASSAT



15 PCS

CEBADOR INYECCIÓN DIESEL

52801 26,00€

0.10	5	50	600
Kg	sub	ff	tbl

- Durante la sustitución de la bomba de inyección, filtros u otras partes, evita el retroceso del combustible hacia el depósito.
- Posteriormente al montaje de las partes a sustituir permite bombear el combustible hacia la bomba de inyección.



BOMBA MANUAL PARA EXTRACCIÓN DE GASOIL

52789 15,20€

0.15	10	24	192
Kg	sub	ff	tbl

- Largo manguera: 90cm por extremo.



CARRETE DE MANGUERA PARA ACEITE BOCA DE 1/2"

50797 490,00€

26.60	-	1	14
Kg	sub	ff	tbl

- Soporte para manguera aceite
- Longitud de la manguera: 15+1 m
- Presión máxima de trabajo: 160 bar
- Entrada: 1/2" BSPT
- Salida: 1/2" BSPT
- Material: Acero



15m **160 BAR**

PISTOLAS DE SUCCIÓN TRANSPARENTES

52498 58,00€

0.85	-	10	120
Kg	sub	ff	tbl

- Fabricada en polipropileno.
- Cuerpo transparente.
- Apta para uso con aceites de transmisión.
- Resistente a líquido de freno y anticongelantes.

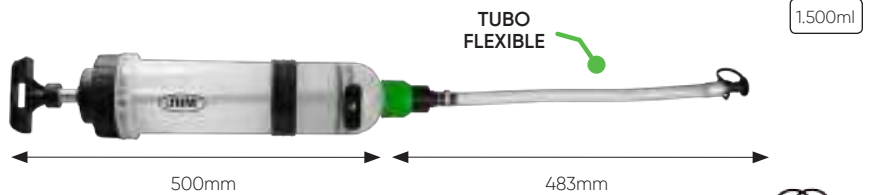

JUEGO DE 2 JUNTAS DE RECAMBIO PARA REF. 52498

11867 0.02 100
9,00€ Kg ff

52628 26,50€

0.25	5	20	360	200ml
Kg	sub	ff	tbl	

- Apto para uso con líquido de freno.
- Conector rápido en el extremo.

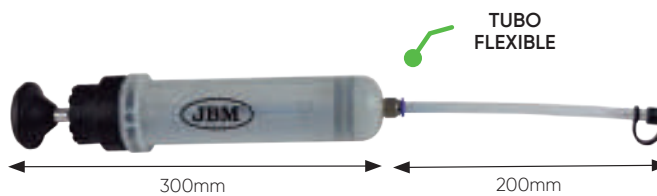

PISTOLA SE SUCCIÓN DE ACEITE

51928 14,00€

0.82	5	20	420
Kg	sub	ff	tbl



PISTOLA ENGRASADORA MINI

53849 16,10€

0.30	-	40	880
Kg	sub	ff	tbl

- Esta pistola engrasadora es perfecta para barcos, motos, bicicletas eléctricas, bicicletas o cualquier otra máquina o equipo que necesite lubricación.
- Muy cómoda para trabajar con una sola mano.

- Boquilla 0.5mm.
- Tapón extraíble con tubo 50°.



PISTOLA ENGRASADORA MANUAL CON TUBO FLEBIXLE

50852 24,50€

500ml

1.30	5	20	240
Kg	sub	ff	ff



PISTOLA ENGRASADORA NEUMÁTICA

50751 43,00€

1.50	5	10	150
Kg	sub	ff	ff

- Tubo rígido
- Tubo flexible
- Presión: 30Mpa



ACOPLADOR DE GRASA DE LIBERACIÓN RÁPIDA

53592 25,00€

Se recomienda utilizarlo con las pistolas engrasadoras JBM ref. 50751 y 50852, aunque es adecuado para su uso en la mayoría de las pistolas.

0.15	25	100	-
Kg	sub	ff	ff

- Diseño ergonómico.
- Fácil de manejar: hace que acoplar y desacoplar se realice totalmente sin esfuerzo y ahorrando tiempo de trabajo.
- La válvula de no retorno integrada permite desconectar la unidad fácilmente a presiones de hasta 15.000 PSI (1.034 bar).
- Conexión NPT de 1/8" integrada.



SET DE ACCESORIOS PARA PISTOLA ENGRASADORA

54255 68,00€

1.60	-	10	500
Kg	sub	ff	ff

- x1
- x1
- x1
- x1
- x1
- x1



300mm

7 PCS

360°

330mm

90°

RECOGEDORES PVC

PVC muy resistente / Compacto.

PARA ANTICONGELANTE

53215 19,00€

0.95	-	6	60
Kg	sub	ff	ff

18L

- Medidas:
Alto: 185mm / Diámetro: 380mm.



PARA ACEITE

53144 18,00€

0.99	-	6	48
Kg	sub	ff	ff

18L

- Medidas:
Alto: 185mm / Diámetro: 380mm.



BANDEJA DE DRENAJE DE ACEITE

54051 39,00€

1.95	-	4	32
Kg	sub	ff	ff

110mm

600mm

330mm

8L

PE

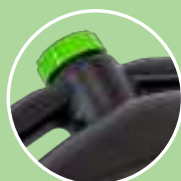

BANDEJA DE ACERO PARA LÍQUIDOS

51356 48,00€

3,00 - 5 30
Kg SUB ff

23 L

110mm 400mm 600mm



ACEITERA 250ml

52243 8,50€

0,14 5 60 720
Kg SUB ff

250ml

130mm

125mm

JARRA CON CUELLO FLEXIBLE

52991 10,50€

0,16 - 20 240
Kg SUB ff

2L

52992 18,00€

0,30 - 8 96
Kg SUB ff

5L

ACEITERA 500ml

52242 12,00€

0,28 10 60 480
Kg SUB ff

160mm

120mm

EMBUDO PARA BIDÓN DE 200L CON TAPA Y FILTRO

53187 39,00€

0,75 - 18 54
Kg SUB ff

4,5L

- Ø Interior: 245mm.
- Ø Exterior: 260mm.

FILTRO

SET DE 3 EMBUDOS

53188 7,00€

0,15 - 24 288
Kg SUB ff

Ø 90mm
130mm
180mm

EMBUDO CON FILTRO

52391 5,00€

0,09 5 20 240
Kg SUB ff

950ml

140 x 15mm

EMBUDO CON TUBO FLEXIBLE

53198 9,50€

0,15 - 24 144
Kg SUB ff

Ø 180mm

1,89L

530mm



HERRAMIENTAS HIDRÁULICAS

- 260 GATOS DE CARRETILLA
- 262 GATOS BOTELLA
- 263 CABALLETES
- 265 PORTA RUEDAS
- 266 PRENSAS
- 267 GRÚAS
- 268 SOPORTES PARA MOTORES
- 269 PARA MOTOCICLETAS
- 270 TRANSPALET

GATO HIDRÁULICO - SISTEMA SUBIDA RÁPIDA

53725 248,00€

32,00 - 1 18



↑ 465mm
↓ 133mm

3T



CUMPLE CON: EN 1494:2001

344mm 682mm 155mm

PROTECCIÓN DE GOMA



PISTÓN DE RECAMBIO

14709 122,00€
6,15 5
Kg U

GATO HIDRÁULICO 3TON CON PALANCA DE ELEVACIÓN

53422 368,00€

44,50 - 1 15



↑ 533mm
↓ 100mm

3T



CE

372mm 778mm 165mm

PROTECCIÓN DE GOMA

ESPUMA

PALANCA DE ELEVACIÓN

RUEDAS DE NYLON



RUEDA GIRATORIA PARA REF. 53422

14071 25
21,50€ U

RUEDA FIJA PARA REF. 53422

14072 25
21,50€ U

PISTÓN PARA REF. 53422

14073 3
128,00€ U

GATO HIDRÁULICO 3T CON PEDAL

53112 298,00€

39,95 - 1 18



↑ 520mm
↓ 140mm

3T



CE

345mm 720mm 185mm



SUBIDA RÁPIDA



PISTÓN HIDRÁULICO PARA GATO REF. 53112

13853
122,00€

PROTECTOR DE GOMA PARA GATO REF. 53112

13836
9,00€

GATO HIDRÁULICO 2TON COCHES BAJOS

53421 298,00€

33,50 - 1 18

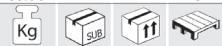

↑ 505mm
↓ 75mm

2T

DOBLE PISTÓN



CE

360mm 740mm 150mm

PROTECCIÓN DE GOMA

ESPUMA

RUEDAS DE NYLON



RUEDA GIRATORIA PARA REF. 53421

14068 50
13,00€ U

PISTÓN PARA REF. 53421

14070 4
116,00€ U

RUEDA FIJA PARA REF. 53421

14069 50
13,00€ U

GATO HIDRÁULICO 2,5TON COCHES BAJOS

54137 288,00€

30,65 - 1 18



↑ 505mm
↓ 78mm

2'5T

740mm 350mm 150mm



GATO HIDRÁULICO CARRETILLA

50818 198,00€

346mm 685mm 180mm

35,80 - 1 18
Kg SUB if

495mm
133mm
3,5T



CE
EN 1494:2001



GOMA PARA CAZOLETA
PARA REF. 50818, 53725,
53421, 53422

14615 0,05 100
9,50€ Kg if

PISTÓN DE RECAMBIO PARA
REF. 50818

10768 6,35 4
113,00€ Kg if

TORNILLO DE SUJECIÓN
LATERAL PARA REF. 50818

10639 0,34 5
10,90€ Kg if

CAZOLETA DE APOYO
PARA REF. 50818

10769 0,30 1
21,00€ Kg if

MUELLE CRICK
PARA REF. 50818

10770 0,05 50
6,00€ Kg if

GATO HIDRÁULICO CARRETILLA ESPECIAL COCHES BAJOS

50816 88,00€

208mm 508mm 125mm

11,25 - 1 63
Kg SUB if

340mm
90mm
2T



CE

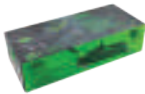

PISTÓN DE RECAMBIO
PARA REF. 50816

14708 10
59,00€ Kg if

GATO HIDRÁULICO CARRETILLA 2T

53968 49,00€

205mm 490mm 140mm

5,80 - 1 90
Kg SUB if

300mm
130mm
2T



CE EN 1494:2001



GATO HIDRÁULICO CARRETILLA 2T

50815 88,00€

205mm 490mm 140mm

10,75 - 1 56
Kg SUB if

355mm
130mm
2T



CE



PISTÓN HIDRÁULICO
PARA REF. 50815 - 51895

11939 6,00 5
63,00€ Kg if

GATO HIDRÁULICO CARRETILLA EN CAJA PLÁSTICA

51895 99,00€

205mm 490mm 140mm

11,68 - 1 42
Kg SUB if

355mm
130mm
2T



CE



PISTÓN HIDRÁULICO
PARA REF. 50815 - 51895

11939 6,00 5
63,00€ Kg if

GATO BOTELLA 20T

50823 94,00€

10,18 - 2 96
Kg SUB fff

↑ 452mm
↓ 242mm

20T



GATO BOTELLA 20T COCHES BAJOS

50824 88,00€

8,47 - 2 120
Kg SUB fff

↑ 335mm
↓ 190mm

20T



GATO BOTELLA 30T

50825 154,00€

7,62 - 2 96
Kg SUB fff

↑ 465mm
↓ 285mm

30T



GATOS BOTELLA 2-15T

50819 28,00€

2,42 - 6 330
Kg SUB fff

↑ 345mm
↓ 181mm

2T

50822 59,00€

5,60 - 4 160
Kg SUB fff

↑ 460mm
↓ 230mm

10T

50820 34,50€

3,20 - 6 300
Kg SUB fff

↑ 372mm
↓ 194mm

3T

52304 84,00€

7,20 - 2 136
Kg SUB fff

↑ 365mm
↓ 225mm

15T



50821 47,00€

4,10 - 5 200
Kg SUB fff

↑ 413mm
↓ 216mm

5T

GATO BOTELLA CON CAJA PLÁSTICA 2-5T

51905 34,50€

2,90 - 6 144
Kg SUB fff

↑ 340mm
↓ 185mm

2T



51906 39,00€

3,53 - 4 144
Kg SUB fff

↑ 385mm
↓ 195mm

3T

51907 48,00€

4,59 - 4 128
Kg SUB fff

↑ 450mm
↓ 215mm

5T



GATO ELEVADOR DE TRINQUETE 3T

53895 107,00€

9,15 - 1 42
Kg SUB fff

↑ 330mm
↓ 130mm

↑ 510mm

265mm

140mm



53896 127,00€

11,60 - 1 28
Kg SUB fff

↑ 645mm
↓ 130mm

↑ 840mm

265mm

140mm

53897 140,00€

13,85 - 1 21
Kg SUB fff

↑ 1045mm
↓ 130mm

↑ 1220mm

265mm

140mm



53898 148,00€

15,65 - 1 21
Kg SUB fff

↑ 1320mm
↓ 130mm

↑ 1520mm

265mm

140mm

- Material: acero 45



GANCHO DE ELEVACIÓN

15096 40,00€ 2,00 10 560
Kg SUB fff

↑ 340mm

87mm

142mm

Diseñado para elevar el vehículo directamente de la rueda cuando se necesita una mayor capacidad de elevación.



SOPORTE DE BLOQUEO DEL MANGO

15095 13,00€ 0,10 50
Kg SUB fff

↑ 125mm

62mm

16mm

Diseñado para bloquear la manivela del gato durante el transporte.



SOPORTE PARA RUEDA DE RECAMBIO

15093 38,00€ 3,65 1 50
Kg SUB fff

↑ 175mm

175mm

158mm

Diseñado para mantener el gato seguro en el soporte para la rueda de repuesto de los 4x4 al circular fuera de la carretera. Su base ajustable lo hace apto para la mayoría de los vehículos.



BASE OFF-ROAD

15094 39,50€ 1,35 5 140
Kg SUB fff

↑ 293mm

293mm

10mm

Diseñado para estabilizar el gato en terrenos blandos, aumentando la superficie de apoyo y evitando el hundimiento.

JUEGO DE DOS CABALLETES

53779 36,00€

5,05 - 1 72
Kg SUB ITT

195mm 205mm

430mm
290mm
3T **2 PCS**



TUV GS CE

53845 64,00€

9,35 - 1 30
Kg SUB ITT

230mm 260mm

610mm
370mm
6T **2 PCS**



TUV GS CE

54143 249,00€

35,50 - 1 12
Kg SUB ITT

500mm
700mm
12T **2 PCS**



TUV GS CE

GATO DE TIJERA

53218 26,00€

2,25 - 6 216
Kg SUB ITT

1,5T 370mm
90mm

CE



- Adecuado para todos los coches.

CABALLETES DE ALUMINIO

53200 69,00€

4,70 - 1 72
Kg SUB ITT

CE

385mm
245mm
3T



54144 298,00€

28,00 - 1 18
Kg SUB ITT

338mm
500mm
22T **2 PCS** CE



54145 377,00€

1,80 - 1 4
Kg SUB ITT

482mm
775mm
10T **2 PCS** CE



54146 492,00€

2,00 - 1 4
Kg SUB ITT

736mm
1212mm
10T **2 PCS** CE

CABALLETE DE ELEVACIÓN 1,8 T

54147 198,00€

0,80 - 1 6
Kg SUB ITT

1200mm
2146mm
1,8T

1 PCS

CE



GATO DE FOSO

54001 285,00€

28.50	-	1	20
Kg	sub	ff	

↑1.900mm
↓1.100mm

900mm

500
KG CE

- Rango de elevación de 116 a 197 cm.
- Permite elevar y mover cajas de cambio, diferenciales, depósitos, etc. de forma segura y estable.
- Soporte de doble posición
Elevación cómoda y rápida con pedal.
- Válvula con muelle para descenso controlado.

SET DE 4 RUEDAS

15526 3,00 25
48,00€ Kg

PISTÓN DE RECAMBIO

15527 15,00 -
276,00€ Kg

SOPORTE DE DOBLE POSICIÓN

15528 1,95 -
39,00€ Kg

2 POSICIONES



VÁLVULA CON MUELLE

VÁLVULA DE SEGURIDAD

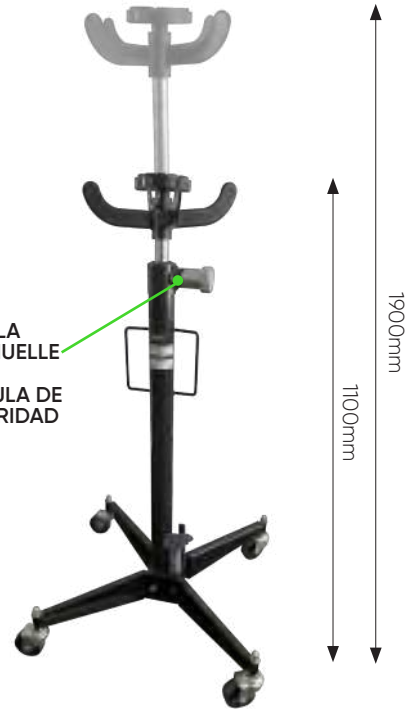

GATO HIDRÁULICO DE TRANSMISIÓN

50830 560,00€

52.10	-	1	6
Kg	sub	ff	

- Con agarradero
- Doble pistón

500
KG

↑1.740mm
↓850mm

CE



SOPORTE DE DOBLE POSICIÓN PARA 50830

14929 1,95 10
35,00€ Kg

Útil para gatos comprados con anterioridad que no lo llevaban incorporado.

PISTÓN DE RECAMBIO PARA REF. 50830

12046 28.50 -
385,00€ Kg

HORQUILLA SUPERIOR GATO FOSO REF.50830

10962 10,60 -
85,00€ Kg

BOMBA HIDRÁULICA MANUAL

54257 318,00€

11.40	-	1	32
Kg	sub	ff	

Presión de trabajo:
Etapa 1: 0-20 kg/cm³
Etapa 2: 20-700 kg/cm³

Caudal por embolada:
Etapa 1: 13cc
Etapa 2: 2.3cc



3/8"
NPT

1,8m

1000
PSI

CE

PORTA RUEDAS HIDRÁULICO

51901 999,00€

75,00	-	1	10

- Largo total: 1040mm.
- Anchura total: 1090mm.
- Altura total: 890mm.
- Rango de elevación: 50 - 100mm.
- Diámetro máx. de las ruedas: 1.320mm.

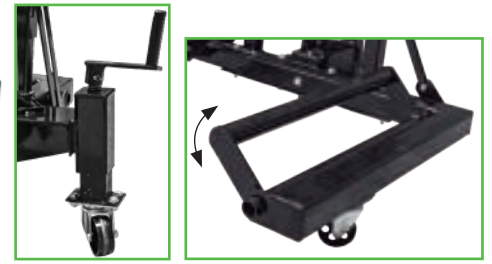

PORTA RUEDAS HIDRÁULICO ESPECIAL PARA RUEDAS TRACTOR

52241 1.690,00€

139,00	-	1	5

- Capacidad: 1,5T
- Rango de elevación: 0-770mm
- Largo total: 1270mm
- Anchura total: 990mm
- Altura total: 1340mm
- Diámetro máximo de rueda: 2200mm (86")
- Diámetro mínimo de rueda: 1000mm (39")
- Ancho máximo de rueda: 800mm



CURVADORA DE TUBOS

50835 290,00€

35,50	-	1	14

DISEÑADO PARA USO VERTICAL Y HORIZONTAL

- Construcción de acero robusto capaz de doblar tubos hasta 2" (50mm).
- Adecuado para instalación y fabricación de tuberías.
- Diseñado para uso horizontal y vertical.
- Barras dobadoras ajustables para acomodar la distancia deseada.

- Capacidad máxima: 12T
- Presión del aire: 0,75 - 0,85mpa
- Dimensiones: 68x58,5x18,5cm
- Tamaños cuñas: 1/2", 3/4", 1", 1-1/4", 1-1/2", 2".



PISTÓN DE RECAMBIO			
13870	6,70	1	
82,00€			

SET DE 6 CUÑAS			
15255	8,75	1	
114,00€			

PRENSA DE 30T

53684 1.880,00€

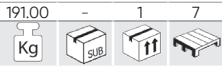

- Capacidad (T): 30.
- Trazo (mm): 160.
- Rango operativo (mm): 166-1126.
- Ancho de la base (mm): 540.
- Accionado manual y con el pie.
- Trazo lateral (mm): 200.
- Recorrido: 150mm

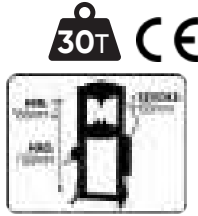

ACCIONADO MANUAL Y CON EL PIE



CABRESTANTE MANUAL PARA AJUSTAR LA ALTURA DE LA MESA DE PRESIÓN

PRENSA DE 20T

53590 1.190,00€

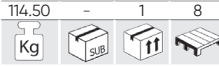

- Capacidad (T): 20.
- Trazo (mm): 145.
- Rango operativo (mm): 58-1018.
- Ancho de la base (mm): 540.
- Ancho interior (mm): 536.
- Trazo lateral (mm): 180.

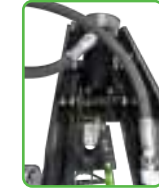

PISTÓN CON DESPLAZAMIENTO HORIZONTAL



2 VELOCIDADES (53590)

PANTALLA PROTECTORA PARA 53684/53590

14616 96,00€

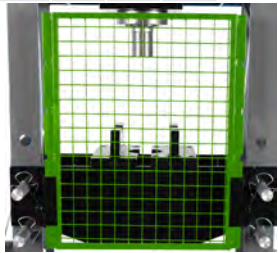
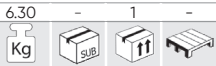

PISTÓN
15044
259,00€

PANTALLA PROTECTORA
14616
96,00€

MANÓMETRO
15047
47,00€

PALANCA
15048
5,00€

MANÓMETRO
15046
47,00€

PISTÓN
15043
195,00€

PALANCA
15048
5,00€

BOMBA
14639
195,00€

BASE DE TRABAJO PARA PRENSA HIDRÁULICA

52999 168,00€

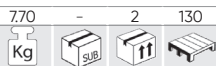

BLOQUE GRANDE



BLOQUE PEQUEÑO



GRÚA DE 2T PLEGABLE

50831 460,00€

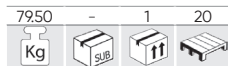

Altura elevación:
1'80m (2T) - 2,19m (½T)
- Dimensiones plegada:
800 x 680 x 1.600mm.
- Capacidad de elevación:
Posición 1: 2T - 80mm.
Posición 2: 1½T - 255mm.
Posición 3: 1T - 425mm.
Posición 4: ½T - 610mm.



GRÚA DE 1T PLEGABLE

52985 598,00€

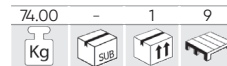

RUEDAS GIRATORIAS PARA REF. 50831



PISTÓN RECAMBIO GRÚA HIDRÁULICA PARA REF. 50831



JUEGO DE TORNILLERIA PARA REF. 50831



RECAMBIO DE PISTONES PARA 52985



JUNTA DEL PISTÓN PARA REF. 52985



SOPORTE ALINEADOR DE MOTOR

50631 68,00€



GRÚA NO INCLUIDA.



COMPRESOR DE MUELLES PARA AMORTIGUADORES

50827 387,00€



- Capacidad: 1T (2200 lbs)
- Diámetro del muelle comprimido: 200mm
- Rango de compresión: 200-500mm



POLIPASTO MANUAL

54262 88,00€



54263 130,00€

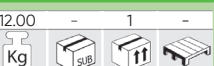

54264 240,00€

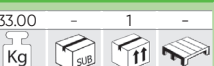

	54262	54263	54264
Altura de elevación	2,8M	2,8M	2,8M
Nº de ramas	1	2	2
Medidas paso cadena	Cadena de carga: 6x30mm Cadena manual: 4,5x25mm	Cadena de carga: 6x30mm Cadena manual: 4,5x25mm	Cadena de carga: 6x30mm Cadena manual: 4,5x25mm
Longitud	Cadena de carga: 3m Cadena manual: 2,5m	Cadena de carga: 3m Cadena manual: 2,5m	Cadena de carga: 3m Cadena manual: 2,5m
Esfuerzo para carga máxima	304N	310N	361N
Material	Cadena de carga: Acero 20Mn2 Cadena manual: Acero Q235	Cadena de carga: Acero 20Mn2 Cadena manual: Acero Q235	Cadena de carga: Acero 20Mn2 Cadena manual: Acero Q235

SOPORTE PARA MOTORES

50840 138,00€

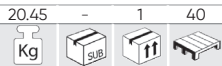

1750mm



ENGANCHE Y PALOMILLA PARA REF. 50840

51452

69,00€

3,43

Kg

1

ff

53682 98,00€

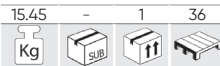

1480mm



SOPORTE PARA MOTOR UNIVERSAL

52055 129,00€



- Adaptable a todo tipo de automóviles y furgonetas.
- Ideal para el cambio de la correa de distribución o de las correas auxiliares.
- Manejo simple.
- Rápida colocación con sólo la necesidad de un operario.
- Colocación y acceso por la parte inferior.
- Pieza perpendicular con ángulo de giro y ajustable a cualquier altura de la barra longitudinal.
- Altura de los ganchos ajustable, 360° de rotación de los ganchos.
- Platina plástica de apoyo para evitar el desplazamiento del punto de apoyo de la barra.



SOPORTE PARA MOTORES

50836 148,00€

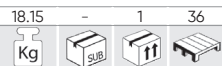

850mm

900mm

800mm



50838 299,00€

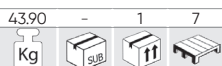

900mm

1,100mm

900mm



- Dimensiones plegado: 100 x 50 x 44cm.

CABALLETE ELEVADOR PARA MOTO

53969 96,00€

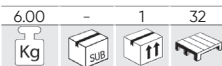

328mm

293mm

400mm
300mm

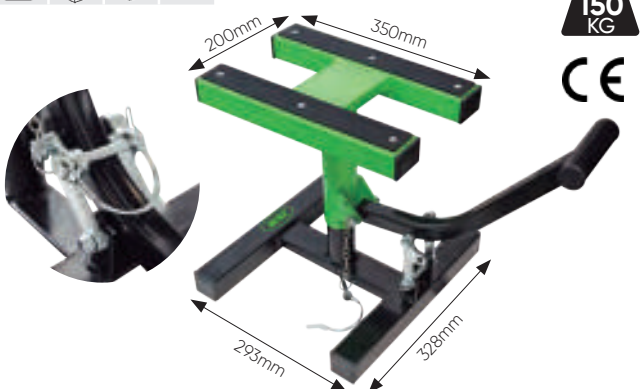

GATO PARA MOTOCICLETA

52692 129,00€

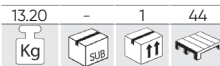

400mm
95mm



- Accionamiento con vaso de 21mm.



MESA HIDRÁULICA

53246 1.144,00€

104.00	-	1	4
Kg	Sub	↑	↓

↑ 1.350mm
↓ 370mm

360
KG



DOBLE TIJERA

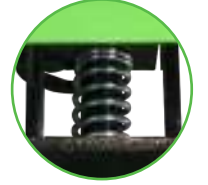

MESA HIDRÁULICA

50630 590,00€

63.00	-	1	4
Kg	Sub	↑	↓

480mm

840mm

↑ 780mm
↓ 290mm

400
KG

CE

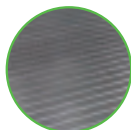

MESA HIDRÁULICA PARA MOTOCICLETAS

50911 788,00€

135.00	-	1	5
Kg	Sub	↑	↓

↑ 780mm
↓ 205mm

365
KG

CE



PISTÓN DE RECAMBIO
PARA REF. 50630

10993 8.80 1
117,00€ Kg

MUELLE DEL PISTÓN
PARA REF. 50630

11950 0.03
18,00€ Kg

SET DE 2 RUEDAS CON
FRENO PARA 50911

14706 0.00 -
8,90€ Kg

PISTÓN DE RECAMBIO
PARA REF. 50911

14727 7.10 1
108,00€ Kg

MESA HIDRÁULICA PARA MOTOCICLETAS

51750 299,00€

31.00	-	1	12
Kg	Sub	↑	↓

500mm

450mm

340mm

↑ 890mm
↓ 340mm

135
KG

CE



GATO ELEVACIÓN QUAD

53423 199,00€

29.40	-	1	24
Kg	Sub	↑	↓

790mm

370mm

330mm

680
KG

CE

NYLON
↑ 368mm
↓ 118mm



PALANCA DE
ELEVACIÓN

RUEDAS
DE NYLON

PISTÓN PARA REF. 53423

14291 4.60 3
87,00€ Kg

SET DE 2 RAMPAS ELEVADORAS

52845 170,00€



20,00	-	1	8
Kg	sub	ft	ft

- Útil para presentar vehículos de exposición, así como para realizar trabajos de mantenimiento en la parte inferior del vehículo.

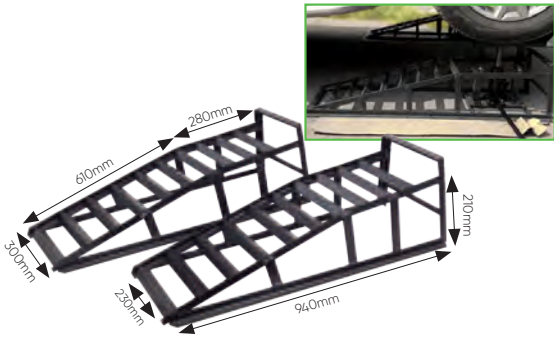

PORTADOR HIDRÁULICO 680Kg

50839 180,00€



19,20	-	1	10
Kg	sub	ft	ft

- Longitud plástico negro de las patas: 300mm.
- Longitud con ruedas: 600mm.



PISTÓN PARA REF. 50839

15085 5,30 1
156,00€ Kg ft

RUEDA PARA REF. 50839

12889 0,65 30
12,00€ Kg ft

SOPORTE ELEVADOR PARA MOTOS

DELANTERO

52514 84,00€

4,00	-	1	26
Kg	sub	ft	ft



GARRAS PARA SOPORTE ELEVADOR DE MOTO

PLANAS (x2)

10671 0,63 2 255mm
15,20€ Kg ft

TRASERO

51751 99,00€

5,00	-	4	12
Kg	sub	ft	ft



REDONDAS (x2)

11892 0,15 50 20mm
12,50€ Kg ft

CARRO TRANSPORTADOR ESPECIAL PLANCHA

50923 454,00€

36,40	-	1	18
Kg	sub	ft	ft

- Separación de 0 a 110cm.

RUEDA PARA REF. 50923

12022 33,70€

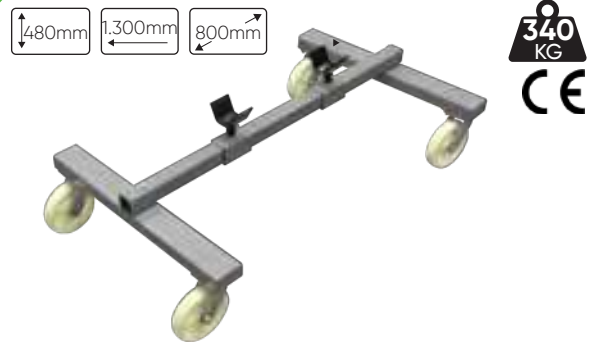

SET DE 4 TACOS PARA ELEVACIÓN TESLA

54175 34,00€

0,80	5	20	280
Kg	sub	ft	ft

NR GAUCHO RUBBER

TESLA 3/X/S/Y



TRANSPALLET MANUAL ELEVACIÓN RÁPIDA

53880 598,00€



84,50	-	1	6
Kg	sub	ft	ft

- Capacidad de carga: 2500kg
- Longitud horquilla: 1150mm
- Empuñadura: Cuadrada con protección de goma.
- Ruedas de dirección: PU (200x50mm)
- Rodillos de carga: PU (80x70mm)
- Altura mínima horquilla: 85mm
- Altura máxima horquilla: 200mm
- Velocidad de elevación: 8



BOMBA DE ELEVACIÓN RÁPIDA (ACERO FUNDIDO)

PU 80x70mm

RODILLO DE HORQUILLA

14938 1,00 10
42,00€ Kg ft

RUEDA DE DIRECCIÓN

14939 2,60 4
57,00€ Kg ft

BOMBA

14940 9,35 1
248,00€ Kg ft

JUEGO DE 2 PASADORES PARA EJE DE BARRA DE TRACCIÓN

14785 0,5 1
3,50€ Kg ft



270

TRANSPALETA ELÉCTRICA

53777 4.352,00€

133,50	-	2	2
Kg	sub	ft	ft



DISEÑO INNOVADOR
- Unidad hidráulica sellada
- Fácil mantenimiento
- Bajo nivel de ruido
x2 llaves
RUEDAS PU / PV



www.jbmcamp.com

IVA no incluido



HERRAMIENTAS ELÉCTRICAS

- 272 ARRANQUE DE VEHÍCULOS
- 273 CARGADORES / COMPROBADORES DE BATERÍA
- 274 MEDIDORES DE CORRIENTE
- 275 TERMÓMETROS
- 276 ENDOSCOPIOS
- 277 SOLDADORES
- 278 AMOLADORA DE MESA
- 279 LIMPIADORAS DE PIEZAS
- 280 ASPIRADORAS
- 281 CALEFACTORES / ROBOT CORTACÉSPED
- 282 HIDROLIMPIADORAS
- 283 CARRETES DE CABLE ELÉCTRICO
- 284 VENTILADORES

CABLES DE ARRANQUE

PINZA MACIZA DE LATÓN

REF.	Ø CABLE + FUNDA	LARGO	A	SECCIÓN	Kg			€
51238	17mm	5m	700	70mm ²	4,95	2	84	138,00€
51239	15mm	7m	700	70mm ²	5,90	2	72	159,00€

PINZA DE LATÓN

REF.	Ø CABLE + FUNDA	LARGO	A	SECCIÓN	Kg			€
52069	11mm	2,5m	250	25mm ²	1,55	10	240	29,50€
52070	12mm	3m	350	35mm ²	1,95	5	160	40,00€
52071	13mm	3m	500	50mm ²	2,35	5	90	47,00€

PINZA MACIZA DE LATÓN CON PROTECTOR SOBRECARGA

REF.	Ø CABLE + FUNDA	LARGO	A	SECCIÓN	Kg			€
51363	12mm	3m	350	35mm ²	2,63	5	120	114,00€
51365	12mm	3m	600	50mm ²	3,10	5	90	118,00€



PINZA PARA CABLE DE ARRANQUE COBRE - ROJA

14145	0,20	30
8,50€	Kg	



PINZA PARA CABLE DE ARRANQUE LATÓN - ROJA

14147	0,35	15
25,00€	Kg	



PINZA PARA CABLE DE ARRANQUE COBRE - NEGRA

14146	0,20	30
8,00€	Kg	

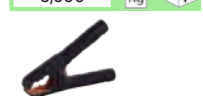

PINZA PARA CABLE DE ARRANQUE LATÓN - NEGRA

14148	0,35	15
25,00€	Kg	

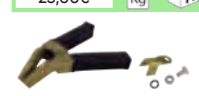

SET DE 2 PINZAS DE COCODRILO

53357	0,01	6	24
7,00€	Kg		



2 PCS 30 AMP

ARRANCADOR DE VEHÍCULOS

53687 298,00€

11,35	-	1	14
Kg			

12V 9,5kg

53688 495,00€

18,05	-	1	14
Kg			

- Voltaje: 12V.
- Batería: 22Ah batería de plomo ácido AGM (1PC).
- Corriente de arranque: 750A.
- Corriente máxima: 1500A.

53688

12V 16,3kg

- Voltaje: 12V/24V.
- Batería: 22Ah batería de plomo ácido AGM (2PC).
- Corriente de arranque / máxima: 12V: 1500A/3000A. 24V: 750A/1500A.
- Tiempo de carga de la batería: Batería totalmente descargada: 8 horas. Batería cargada un 10-20%: 4 horas.



PINZAS



LUZ LED INCORPORADA: AMPLÍA LA VISIBILIDAD DE LA ZONA DE TRABAJO

CE

370mm 392mm 209mm

Medidor de voltaje de la batería interna

Botón de comprobación de voltaje de la batería interna

Interruptor encendido/apagado

Toma de carga



RECAMBIOS

REF.	CARACTERÍSTICAS	Kg		€
14755	Batería 22Ah para ref. 53687,53688	6,50	2	134,00€
14756	Placa base para ref. 53687	0,05	10	15,20€
14757	Placa base para ref. 53688	0,05	10	15,20€
14758	Cable de arranque rojo con pinza para ref. 53687	0,40	10	18,00€
14759	Cable de arranque negro con pinza para ref. 53688	0,40	10	18,00€
15782	Cable de arranque negro con pinza para ref. 53687	0,30	10	16,00€
15781	Cable de arranque rojo con pinza para ref. 53688	0,30	10	19,84€

53688



14757

15781



14759



14755



53688 53687

53687

14756



14758



15782



MEMORIZADOR PARA CAMBIO DE BATERÍA

52884 73,00€

0,25	5	20	360
Kg	Sub	ff	ff



235mm ± 20mm

2.070mm ± 20mm

- Útil para mantener corriente en el sistema eléctrico del vehículo durante el cambio de batería.
- Conexión mediante cable OBDII o toma de mechero.

CARGADORES DE BATERÍA

6/12V

53927 66,00€

0,65	5	20	240
Kg	Sub	ff	ff



12/24V

53929 95,00€

0,90	5	20	240
Kg	Sub	ff	ff



COMPATIBLE CON TODAS BATERÍAS DE PLOMO ÁCIDO

MEDIDOR DE AISLAMIENTO

54114 248,00€

1,48	-	10	100
Kg	Sub	ff	ff

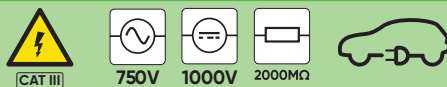

Este instrumento le permite medir el aislamiento eléctrico a una tensión eléctrica determinada (250V, 500V o 1000V). Es una herramienta imprescindible para poder evaluar la integridad del aislamiento de un circuito eléctrico, especialmente necesaria para comprobar que los componentes e instalación en los coches eléctricos están completamente aislados de la carrocería. En instalaciones industriales, es la herramienta que permite realizar comprobaciones periódicas de la resistencia de aislamiento. Mediciones que son exigidas por la norma DIN VDE 0105-100 (VDE 0105-100):2009-10. Está especialmente indicado para la utilización en vehículos eléctricos e híbridos.

COMPROBADOR DE BATERÍAS DIGITAL

51816 49,00€

0,30	6	48	576
Kg	Sub	ff	ff

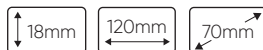

- 150Ah.
- Aplicable en baterías de 12V.
- Medición en SAE (CCA), EN, IEC, DIN, CA.
- Rango: 200~1.200 CAA (SAE).
- Medidor de voltio: 7V-15 V.
- Display 4 + 3 Leds (verde, rojo, amarillo).



COMPROBADOR DE BATERÍAS

51235 49,00€

1,25	-	10	150
Kg	Sub	ff	ff

- Para baterías de 6V y 12V.
- Carga de hasta 100Ah.
- Test de Estado de carga.
- Test de consumo de Arranque.
- Test de Voltaje de carga.
- Test de Condición de la Batería.



COMPROBADOR DE BATERÍA Y ALTERNADORES CON IMPRESORA

52233 328,00€

2,32	-	6	72
Kg	Sub	ff	ff

- Aplicable a baterías de 6V y 12V.
- Sistemas de carga y encendido de 12V y 24V.

- Rango de operación: 40 - 2000 CCA (SAE).
- Voltímetro: 1.5V - 30V.
- Juego de cables de 180cm.

- Incluye: Pilas 6x1.5AA.
- 1 rollo de papel térmico.



CON IMPRESORA

AGM, GEL, VRLA, SLI



DENSÍMETRO PARA BATERÍAS

53209 8,50€

0,14	24	96	768
Kg	Sub	ff	ff

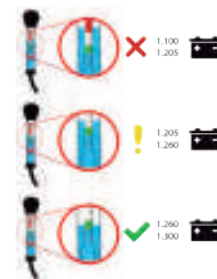

PAPEL TÉRMICO 57mmx60m

51842	0,10	6	72
6,90€	Kg	Sub	ff

IVA no incluido

COMPROBADOR DE BATERÍA CON IMPRESORA

54040 240,00€

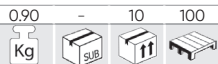

- Aplicable a baterías de 12V
- Rango de operación: 100 - 2000 CCA (SAE)
- Idiomas disponibles en el sistema: ES (Español), EN (Inglés), FR (Francés), DE (Alemán), IT (Italiano), PT (Portugués), RO (Rumano).
- Aplicable a sistemas de arranque de 12/24V
- Aplicable a baterías de 12V, AGM, GEL, VRLA, SLI.
- Comprobador arranque y alternador.

*Incluida una pila CR2032



CON IMPRESORA

Aplicable a baterías de 12V
 Aplicable to batteries of 12V
 AGM GEL VRLA SLI

Aplicable a sistemas de arranque de 12V/24V
 Applicable to starting systems of 12V/24V

x1 CR2032
 Incluidas

-20°C
 50°C

100 - 2000 CCA (SAE)

PINZA AMPERIMÉTRICA

52382 19,50€

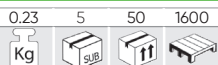

- FUNCIONES:
Test de cable.

- Instrumento ideal para electricistas
- Se puede medir: voltaje AC, voltaje DC, Corriente AC, resistencia, diodo, frecuencia.
- Entorno de funcionamiento: 0°C a 40°C, a <80%RH.
- Entorno de almacenamiento: -10°C a 40°C, a <85%RH.
- Alimentación: 2 pilas AAA.

52952 74,00€



- FUNCIONES:
Test de cable.
Test de diodo.
Test de continuidad.
Función ADP.
Función de detección de fase.
Interruptor ZERO.

- Indicador de batería baja.
- Pantalla de 3,5" con 4 dígitos.
- Función de corriente continua.
- Medición de voltaje AC/DC.

	52382	52952
DCB	600V	20V, 600V
ACB	600V	600V
DCA		200A
ACA	20A, 200A, 600A	200A
OHM	2KΩ, 200KΩ, 2MΩ	2000Ω



52382

52952

MULTÍMETRO DIGITAL

50942 28,00€

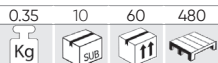

- Indicador de batería.
- Baterías de 9V.
- Sonda de temperatura.
- Temperatura de -40°C a 1000°C.

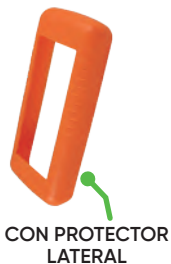

CON PROTECTOR LATERAL



V AC	200mV, 2V, 20V, 200V, 1000V	A AC	20mA, 200mA, 20A
V DC	200mV, 2V, 20V, 200V, 750V	A DC	20mA, 200mA, 20A
Ω	200Ω, 2KΩ, 20KΩ, 200KΩ, 2MΩ, 20MΩ, 2000MΩ		
F	2nF, 20nF, 200nF, 2μF, 20μF, 200μF		



JUEGO DE CABLE Y ACC. PARA REF. 50942

52439 227,00€



- 2 medidores de resistencia variable.
- 2 luces led de comprobación.
- 2 SRS sustitución y de los dispositivos de prueba.
- 2 alicates de cocodrilo.
- 2 tomas de enganche rápido.
- 4 sondas.
- 24 conectores forma redonda.
- 48 conectores forma plana.



SET DE ACCESORIOS PARA MULTÍMETRO

52231 49,00€

0,41	5	20	240
Kg	Sub	ff	ff

- Kit apto para la mayoría de multímetros.

- Incluye:
2 sondas.
2 pinzas pequeñas
2 pinzas largas.
Cables de extensión.



SALVAPICOS 12/24V

54256 48,00€

0,45	-	20	800
Kg	Sub	ff	ff

12V
24V

35V

800 AMP

1500W



COMPROBADOR DE CORRIENTE

53028 5,80€

0,70	10	120	1440
Kg	Sub	ff	ff

6-12-24V

1,8 x 190mm



- Aptos para comprobar la polaridad

53029 6,80€

0,08	12	240	2400
Kg	Sub	ff	ff

6-12-24V

2 x 115mm



53030 12,00€

0,17	6	60	720
Kg	Sub	ff	ff

6-12-24V

LED

3 x 142mm



TERMÓMETRO CON LASER

52162 38,00€

-50° A 550°C

0,17	6	72	576
Kg	Sub	ff	ff

- Termómetro de infrarojos.
- Lectura de: -50°C ~ 550°C / -58°F a 1022°F.
- Tolerancia ± 2°C.

- Funciones:
Indicación por puntero láser.
Alarma de temperatura máxima o mínima.
Lectura en °C / °F.
Función de memoria de resultado.
Indicador de batería baja.



90mm

145mm

37mm



52450 105,00€

-50° A 1.000°C

0,72	5	20	200
Kg	Sub	ff	ff

- Termómetro de infrarojos.
- Lectura de -50°C ~ 1000°C (-58°F ~ 1.832°F).
- Tolerancia +/- 1,5°C.

- Funciones:
Indicación por puntero láser.
Alarma de temperatura máxima o mínima.
Lectura en °C / °F.
Función de memoria de resultado.
Indicador de batería baja.



175mm

105mm

48mm



TERMÓMETRO DIGITAL DE CONTACTO

53503 12,00€

0,05	20	100	2400
Kg	Sub	ff	ff

1.5V x1

-50°C - 330°C
-58°F - 572°F
1°C/0.2°F
(-20°C - 90°C)



COMPROBADOR DE LÍQUIDO DE FRENOS

51839 24,00€

0,05	25	100	2400
Kg	Sub	ff	ff

- Funciona a pilas 1xAAA LR03.
- Con 4 niveles de calidad medibles del 0% al 4%.



ENDOSCOPIO WIFI

53724 46,00€

0,15 - 50 800

Kg SUB if



- Endoscopio con conexión wifi compatible con todos los smartphones del mercado. Apta para conectar con tabletas y PC.

- El equipo incluye:
Endoscopio.
Cargador.
Punta de gancho.
Punta magnética.
Punta con espejo para visión lateral.



2560x1920
1280x720
640x480

SMP

- Resolución: **2560x1920 / 1280x720 (720p 16:9) / 640x480 (480p 4:3).**
 - Fotogramas: **20fps.**
 - Pixel: **5,0mp.**
 - Ángulo de visión: **70 grados.**
 - Diámetro: **5,5mm.**
 - Distancia focal: **4-6cm.**
 - **6 LED** blancos ajustables.
 - Resistencia al agua **IP67** (hasta 1 metro).
 - Batería de litio **2600mAh.**

CABLE DE 1M SEMIRÍGIDO

Ø 5,5MM



FUNCIONA CON LA APP DE JBM:



ENDOSCOPIO INDUSTRIAL CABLE 1m

52436 680,00€

2,41 - 5 40

Kg SUB if

- Alimentación: DC5.
 - Monitor 3,5TFT 320x240px.
 - Interfaz: MINI USB 1,1/AV.
 - Batería: Recargable Li-Polymer 3,7V.
 - Adaptador de corriente: 100-240V.
 - AC en salida 5VDC.
 - Video en NTSC&PAL.
 - Almacenaje: CARD SD (hasta 32Gb).
 - Compresión: JPG.
 - Grabación: MPEG4 (640x480).
 - Temperatura de trabajo: -20°C - 60°C.
 - Temperatura almacenado: 0°C - 40°C.
 - Diam. cable: 5mm.
 - Funciones: salida de video, 6 idiomas, auto-off, fotos, videos.



PANTALLA EN COLOR

1M

RECAMBIO PUNTA PARA ENDOSCOPIO

11992 0,01 20
65,00€ Kg if

CABLE 3m

11219 0,32 1
659,00€ Kg if

CABLE 1m

11329 0,22 1
564,00€ Kg if

DETECTOR DE FUGAS POR HUMO

53484 615,00€

4,70 - 4 32

Kg SUB if

12V 6 L/m 15PSI



- NO INCLUYE ACEITE.

275mm 220mm 235mm

ACEITE 500ML PARA REF. 53484

14081 0,50 48 960
12,60€ Kg if

TUBO RECAMBIO PARA 53484

14109 0,01 20
29,00€ Kg if

BOMBA INFLADOR PARA 53484

14110 0,20 20
110,00€ Kg if

VIDEOTUTORIAL DISPONIBLE EN



Incluye:



PISTOLA DE ADHESIVO TERMOFUSIBLE

51831 24,00€

0,35 12 36 288

Kg SUB if

- Voltaje: 100~ 230 V.
 - Temperatura: 190~230 °C.
 - Consumo: 60~150 W.
 - Ø de boquilla: 2,0~2,3 mm.
 - Rango: 8 - 16g de producto/min.



ADHESIVO TERMOFUSIBLE 10 unidades

51859 0,12 8 32 1520
3,80€ Kg SUB if

- Ø 8mm.
 - Pega rápidamente todo tipo de materiales flexibles.
 - Tiempo de secado: 20".



SOLDADORES

53977 17,50€

0,30	12	48	576
Kg	Sub	11	11

- Voltaje 220-240V
- 40W
- Frecuencia: 50Hz
- Largo: 240mm
- Cable: 1,3m
- Temperatura de trabajo máxima: 450° +/- 10%



53111 19,00€

0,30	5	25	625
Kg	Sub	11	11

- Voltaje: 220-240V.
- Temp.: 420°C + / - 10%.
- Largo: 250mm.
- Cable: 1,5m.



SOLDADOR INVERTER MMA

53981 143,00€

3,35	-	1	90
Kg	Sub	11	11

100A DC

- Adecuado para soldar en acero y hierro con todo tipo de electrodos.
- Tamaño pequeño, peso ligero.
- Buen arranque y fuerza del arco, arco estable y pocas salpicaduras.
- Alta calidad de soldadura, penetración profunda.
- Protección automática de sobretensión, sobrecorriente y sobrecalentamiento.
- La tecnología IGBT mejora enormemente la fiabilidad.
- Corriente de soldadura estable a pesar de la fluctuación de la tensión de entrada, puede equilibrarse automáticamente cuando la tensión de entrada fluctúa.



- ✓ TECNOLOGÍA INVERTER IGBT
- ✓ MMA DC
- ✓ ANTI STICK
- ✓ ARC FORCE
- ✓ HOT ARC START

- Incluye:
- Portaelectrodo con cable de 2m.
- Pinza de masa para soldadura con cable de 1.5m.
- Máscara protectora facial.
- Martillo de soldadura con cepillo.

1ph AC 230V	50Hz	3.7 KVA	16A	65V
100A 24V	10-100A	0.7	IP21S	F



RECAMBIOS PARA REF. 53981

REF.	CARACTERÍSTICAS	€
15237	Portaelectrodo con cable de 2m	12,00€
15238	Martillo de soldadura con cepillo	5,00€
15239	Máscara protectora facial	5,50€
15240	Pinza de masa para soldadura con cable de 1.5m	9,50€
15241	Placa base	65,00€
15242	Conector rápido negativo/positivo	2,50€
15243	Ventilador	4,00€
15244	Interruptor	2,00€

53982 219,00€

6,10	-	1	33
Kg	Sub	11	11

160A DC

- Adecuado para soldar en acero y hierro con todo tipo de electrodos.
- Tamaño pequeño.
- La tecnología IGBT mejora enormemente la fiabilidad.
- Protección automática de sobretensión, sobrecorriente y sobrecalentamiento.
- Corriente de soldadura estable a pesar de la fluctuación de la tensión de entrada, puede equilibrarse automáticamente cuando la tensión de entrada fluctúa.



- ✓ TECNOLOGÍA INVERTER IGBT
- ✓ MMA DC
- ✓ ANTI STICK
- ✓ ARC FORCE
- ✓ HOT ARC START

- Incluye:
- Portaelectrodo con cable de 2m.
- Pinza de masa para soldadura con cable de 1.5m.
- Máscara protectora facial.
- Martillo de soldadura con cepillo.

1ph AC 230V	50Hz	16A	65V	6.5 KVA
160A 26.4V	IP21S	10-160A	0.7	F



RECAMBIOS PARA REF. 53982

REF.	CARACTERÍSTICAS	€
15238	Martillo de soldadura con cepillo	5,00€
15239	Máscara protectora facial	5,50€
15245	Pinza de masa para soldadura con cable de 1.5m	7,50€
15246	Placa base	108,00€
15247	Conector rápido negativo	2,50€
15248	Conector rápido positivo	2,50€
15249	Ventilador	5,00€
15250	Interruptor	4,50€
15251	Portaelectrodo con cable de 2m	15,00€

PISTOLA DE CALOR 2000W

53145 39,20€



- 220V-240V.
- 50Hz-60Hz.



- 2000W.
- Temperatura de salida: 50-600°C.
- Flujo de aire: 220-480L/min.
- 2 opciones de temperatura: 300 y 600°C.

53162 60,00€

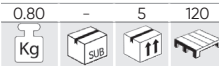

- 220V-240V.
- 50Hz-60Hz.
- 2000W.



- Temperatura de salida: 100-600°C.
- Flujo de aire: 280-480L/min.

DIGITAL

MÁQUINA PARA RALLAR NEUMÁTICOS

52643 596,00€

POTENCIA MÁXIMA 350W

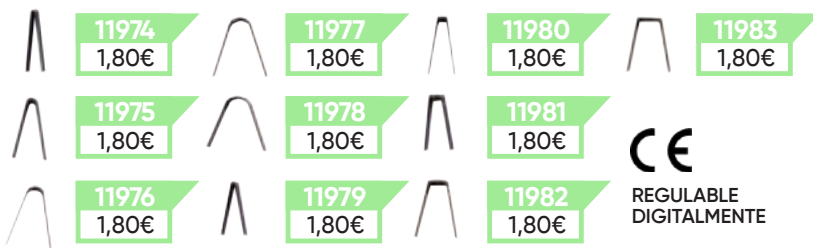
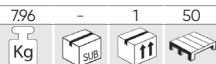

CE

REGULABLE DIGITALMENTE

RECAMBIOS

REF.	11974	11975	11976	11977	11978
TIPO CUCHILLA	R1	R2	R3	R4	R5
CUCHILLA REDONDA	mm	mm	mm	mm	mm
A	3	5	6	8	10
B	7	7	10	12	12
C	5	8	15	16	18
D	21	21	23	25	24

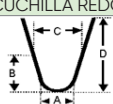

REF.	11979	11980	11981	11982	11983
TIPO CUCHILLA	W1	W2	W3	W4	W5
CUCHILLA CUADRADA	mm	mm	mm	mm	mm
A	3	5	7	9	11
B	7	7	10	12	12
C	5	6	10	13	15
D	21	21	22	24	23

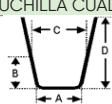

AMOLADORAS ELÉCTRICAS

450W

53656 198,00€

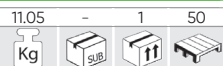

230V
450W
2950 RPM



600W

53657 248,00€



230V
600W
2950 RPM



250W

53658 99,00€



230V
250W
2950 RPM



250W

53659 121,00€



230V
250W
2950 RPM



BASE METÁLICA PARA AMOLADORA

53660 146,00€

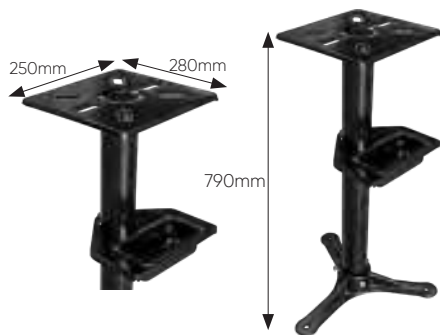
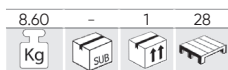

- Altura: 790mm.
- Medidas de la placa de fijación: 250x280mm.
- Peso: 8kg.

AMOLADORA ELÉCTRICA 150mm

52195 170,00€

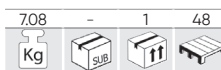

- Potencia nominal entrada: 250W.
- Tensión nominal: 230V / 50Hz.
- Velocidad sin carga: 2950Rpm.
- Ø de la rueda: 150 x 20 x 12.7mm.



LIMPIADOR DE PIEZAS

52980 480,00€

150L

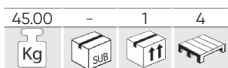

MEDIDAS TOTALES MÁQUINA

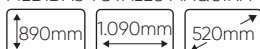

MEDIDAS INTERIORES DEPÓSITO

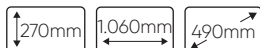

- Caudal: 25L.
- Funciona con soluciones limpia motores solubles en agua.

50632 298,00€

100L

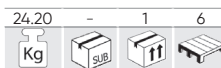

MEDIDAS TOTALES MÁQUINA



MEDIDAS INTERIORES DEPÓSITO



BOMBA RECAMBIO

11101 154,00€
0.71 Kg 20 SUB 120

FILTRO RECAMBIO

11102 6,60€
0.01 Kg 100

PINCEL/BROCHA RECAMBIO

11100 24,30€
0.35 Kg 100 1000

LIMPIADOR DE PIEZAS PORTÁTIL

53220 260,00€



- FORMATO PORTÁTIL.
- Permite el cierre estanco para evitar pérdidas durante el transporte.
- Usar con disolvente de base acuosa.

- Interruptor de encendido lateral.
- Filtro de limpieza de líquido incluido.
- Colgador de herramientas y de manguera incluido.
- Compartimento de almacenamiento.
- Separación de áreas de trabajo, área de limpieza y área de secado, permite el trabajo con varias piezas a la vez.

- Capacidad máxima: 27,5L.
- Capacidad de bombeo: 1.000 L/h.
- Capacidad de trabajo: 20L.
- Conexión a 220V.
- Manguera de 1,10m de largo.



IVA no incluido

ASPIRADORA INDUSTRIAL

51837 195,00€

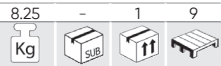

30L

SECO DE 30L



INCLUYE



RECAMBIOS PARA REF. 51837

REF.	CARACTERÍSTICAS	€
10720	Manguera plástico 1,5m	24,50€
11095	Manguera plástico 3m	31,00€
10721	Tubo de metal extensible	19,00€
10761	Filtro	16,00€

51838 667,00€



80L CE

SECO + HÚMEDO 80L



INCLUYE



RECAMBIOS PARA REF. 51838

REF.	CARACTERÍSTICAS	€
10722	Manguera plástico 1,5m	24,50€
11098	Manguera plástico 6m	57,00€
10723	Codo superior	29,50€
10724	Codo inferior	29,50€
10762	Filtro	23,50€

	51837	51838
Capacidad (L)	30	80
Litros de aspiración por segundo (L/s)	26	50
Potencia motores	1x1.200W	3x1.000W
Voltaje	230V	230V
Frecuencia	50Hz	50Hz
Potencia de succión	> 17Kpa	> 20Kpa
Ø manguera	32mm	48mm
Largo manguera	1,5m	2m
Largo cable	4,5m	4,5m
Estanqueidad	IPx4	IPx4

BARREDORA DE EMPUJE MANUAL

54252 199,00€

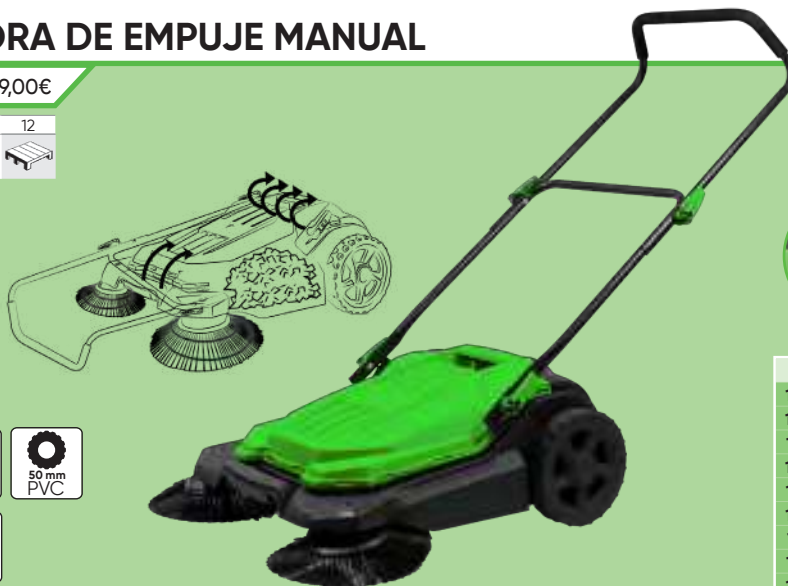

650X15mm



	€	
16165	HEBILLA DE DISCO BARREDOR PARA REF. 54252	2,00€
16166	DISCO CEPILLO BARREDOR PARA REF. 54252	23,50€
16167	SET DE 2 RUEDAS 50MM PARA REF. 54252	7,00€
16168	CORREA DE TRANSMISIÓN PARA REF. 54252	5,00€
16169	PIÑÓN DERECHO PARA REF. 54252	1,50€
16170	PIÑÓN IZQUIERDO PARA REF. 54252	1,50€
16171	SET DE 2 RUEDAS 200MM PARA REF. 54252	20,50€
16172	BARRA DE EMPUJE PARA REF. 54252	22,50€
16173	PINZA DE LA BARRA PARA REF. 54252	3,00€

PULVERIZADOR INDUSTRIAL

53820 388,00€

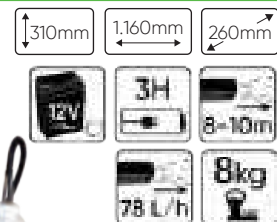
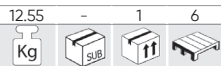

Capacidad del tanque	15L
Distancia de rociado	8-10m
Tamaño del líquido pesticida	<50 micras (µm)
Capacidad del depósito de gasolina	2L
Consumo de gasolina	3,2L/hora

- ALTA EFICIENCIA:
x7-10 veces mayor al pulverizador manual.

- BUENA DIFUSIÓN:
ahorra agua y pesticida.

- DESINFECTA AMPLIAS COBERTURAS
a través de finas partículas en forma de humo.

CALEFACTOR

54229 48,00€ 1.76 - 4 80 Kg SUB ff 210-160-217mm 2Kw 220V/240V 5000 MOOD 20m² SPCC PTC 197 m³/h	54230 68,00€ 3.10 - 1 56 Kg SUB ff 210-160-217mm 3Kw 220V/240V 5000 MOOD 30m² SPCC PTC 197 m³/h	
54231 138,00€ 4.80 - 1 27 Kg SUB ff 300-235-345mm 5Kw 380v/400v 5000 MOOD 48m² SPCC 1,4m PTC 588 m³/h	54232 248,00€ 790 - 1 12 Kg SUB ff 395-307-455mm 9Kw 380v/400v 5000 MOOD 80m² SPCC 1,4m PTC 1180 m³/h	

ROBOT CORTACÉSPED

52598 1.080,00€

1700 Kg SUB ff

- Robot cortacésped autónomo.
 - Fácil de almacenar.

5200 mAh 1400ml
 115,44W 12V 24V 24V DC MOTOR
 2,5H 2H 70 dB
 IP X4 7,5kg 22m/min
 90-33,5-24 cm

ALTURA DE CORTE: 2,5 - 5,5CM
 ANCHO DE CORTE: 18CM
 VELOCIDAD DE GIRO DE LA CUCHILLA: 3500RPM

CONEXIÓN APP





REF.	CARACTERÍSTICAS	€
15424	Cable delimitador 150m	105,00€
15425	Grapas para cable delimitador 150pcs	50,00€
15426	Hoja de corte y tornillos	10,00€
15427	Clavos para estación de acoplamiento	9,00€
15428	Batería 22.2v, 2600mah	238,00€
15429	Cable de extensión 5m	23,50€
15430	Adaptador	83,00€
15431	Estación de carga	241,00€
15432	Conector de cable de conexión	18,50€
15433	Garaje	197,00€
15434	Motor rueda trasera	147,00€
15435	Placa de la corte y placa de protección	24,50€
15436	Motor de corte	97,00€
15437	Placa base (función wifi)	305,50€
15438	Sensor de cable delimitador	31,00€
15439	Ruedas delanteras	52,00€

HIDROLIMPIADORAS DE ALTA PRESIÓN

Hidrolimpiadoras de alta presión con **motor de 1400W / 2400W** de potencia, ideales para limpiar bicicletas, vehículos y otros equipos de exteriores, así como patios, terrazas, invernaderos, etc.

53947 145,00€

5,80 Kg 1 SUB 31

230V	1400W	MAX 105 bar	MAX 50°C	5,0 kg
MAX 8 L/min	3m	5m	50Hz	IP X5

MOTOR
15398 75,00€

- Presión de funcionamiento: 70 bar
- Flujo de funcionamiento: 5.5 L/min
- Presión máxima de entrada del agua: 4 bar
- Dimensiones: 28x25.5x44cm
- Tipo motor: escobillas de carbón
- Incluye:
1 pistola rociadora
1 manguera de alta presión de 3m
1 cable de alimentación de 5m



53948 324,00€

12,10 Kg 1 SUB 10

230V	2400W	MAX 100 bar	MAX 50°C	10,0 kg
MAX 8 L/min	8m	5m	50Hz	IP X5

MOTOR
15399 117,00€

- Presión de funcionamiento: 120 bar
- Flujo de funcionamiento: 5.5 L/min
- Presión máxima de entrada del agua: 4 bar
- Dimensiones: 44x34.5x50.5cm
- Tipo motor: escobillas de carbón
- Incluye:
1 pistola rociadora
1 manguera de alta presión de 8m
1 cable de alimentación de 5m
1 boquilla turbo
1 conector de agua transparente
1 generador de espuma de 750ml
1 limpiador para patios
1 cepillo para llantas
1 cepillo fijo



PISTOLA PULVERIZADORA
15388 20 33,00€

BOQUILLA TURBO
15393 100 12,50€

MANGUERA PVC DE 5M
15389 20 18,50€

CAÑÓN DE ESPUMA
15394 50 26,00€

LIMPIADOR DE SUPERFICIES DE 8 PULGADAS
15390 15 43,00€

CONECTOR DE MANGUERA
15395 50 3,50€

CEPILLO FIJO
15391 50 13,50€

CEPILLO PARA LLANTAS
15392 50 17,50€

CARRETE DE CABLE ELÉCTRICO - 21m

53585 168,00€

8,35	-	2	34
Kg	Sub	Box	Tray

53586 158,00€

5,15	-	2	30
Kg	Sub	Box	Tray

DIFERENCIAL PROTECCIÓN DE SOBRECARGA



CON SOPORTE DE PARED

CON REPARTIDOR

230V	1000W 3000W	H07RN-F 3G1.5mm ²	IP 44
20 m	+	1 m	



SOPORTE DE PARED

14771 10,50€

0,35	30
Kg	Box

CARRETE DE CABLE ELÉCTRICO - 12M

53584 119,00€

5,10	-	4	48
Kg	Sub	Box	Tray

53526 168,00€

8,35	-	2	34
Kg	Sub	Box	Tray

CON SOPORTE DE PARED



CON REPARTIDOR

DIFERENCIAL PROTECCIÓN DE SOBRECARGA

BLOQUEADOR DE CABLE

230V	1000W 3000W	H07RN-F 3G1.5mm ²	IP 44
11 m	+	1 m	



SOPORTE DE PARED

14774 10,50€

0,40	10
Kg	Box

CARRETE DE CABLE ELÉCTRICO

51033 98,00€

3,86	-	2	48
Kg	Sub	Box	Tray

- Protección de sobrecarga.
- Protección infantil.

25m	H07RN-F 3G1.5mm ² PVC	IP 20
-----	--	----------



EXTENSIÓN DE CABLE DE CORRIENTE

53166 10,50€

0,45	5	30	600
Kg	Sub	Box	Tray

3m

53167 12,50€

0,65	5	20	600
Kg	Sub	Box	Tray

5m

53168 19,00€

1,20	5	10	300
Kg	Sub	Box	Tray

10m



IVA no incluido

VENTILADOR PARA VEHÍCULO 12V

53543 13,80€

0,75 5 20 160

Kg sub ft cm



x2 VELOCIDADES



VENTILADOR DE COCHE DOBLE

53600 13,80€

0,55 5 20 160

Kg sub ft cm



VENTILADORES

DE PIE

53189 128,00€

7,10 - 1 12

Kg sub ft cm



PULVERIZADOR DE AGUA

54125 152,00€

8,25 - 1 14

Kg sub ft cm



Mando a distancia

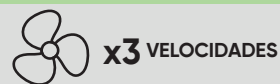
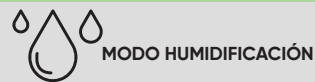

DE SUELO

53190 98,00€

6,10 - 1 16

Kg sub ft cm

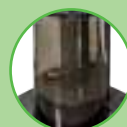

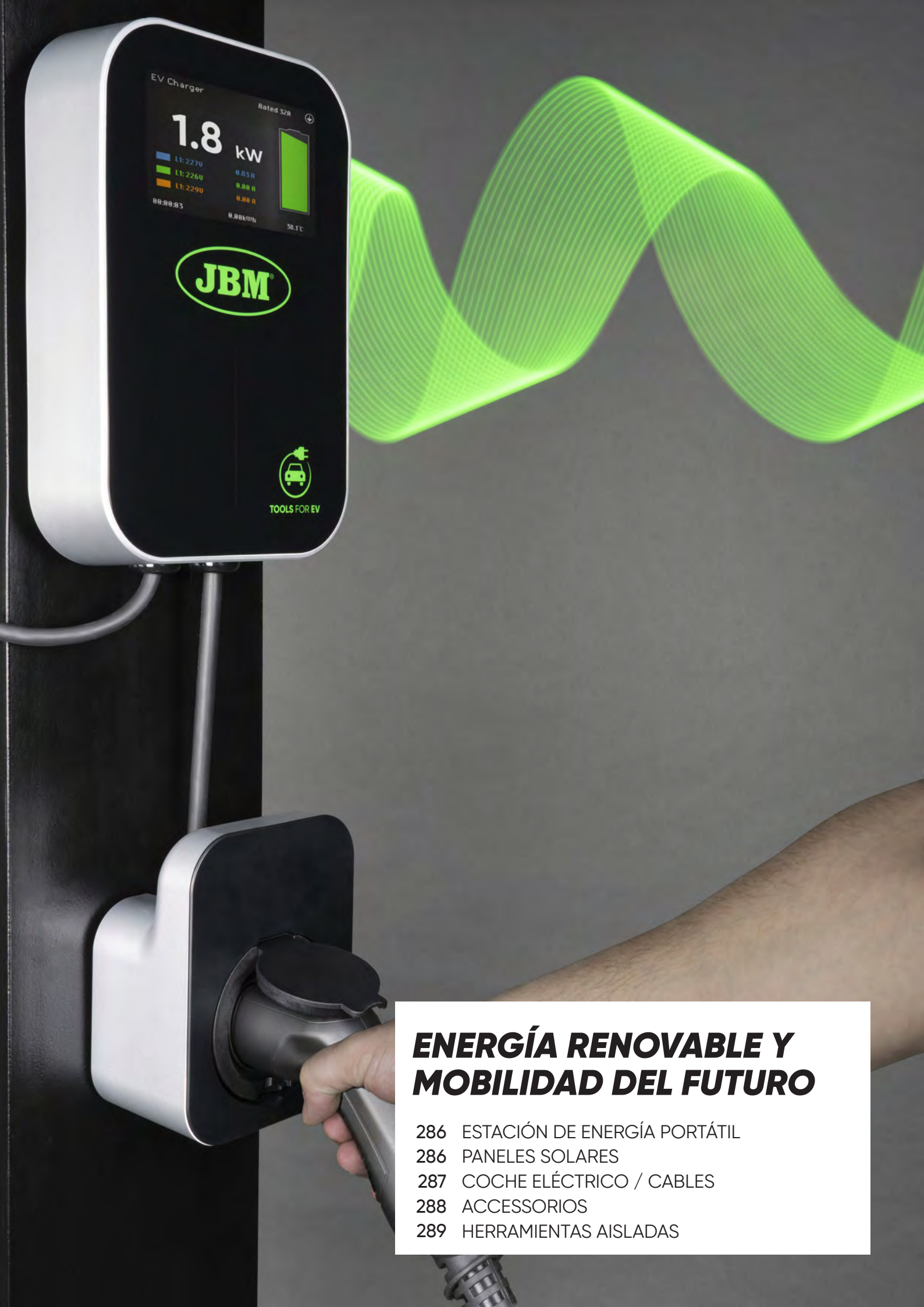

ENERGÍA RENOVABLE Y MOBILIDAD DEL FUTURO

- 286 ESTACIÓN DE ENERGÍA PORTÁTIL
- 286 PANELES SOLARES
- 287 COCHE ELÉCTRICO / CABLES
- 288 ACCESORIOS
- 289 HERRAMIENTAS AISLADAS

ESTACIÓN DE ENERGÍA PORTÁTIL 1920WH / 48V 40 AH

53970 3.790,00€

La central eléctrica portátil es un generador eléctrico portátil de gran capacidad que se recarga con energía solar, pero también puede recargarse en cualquier toma de corriente, en ausencia de luz solar.

34,70 - 1 13
Kg SUB

Saida normal de CA Rated AC output 3000W	Carga rápida Fast Charging 54V/10A 3-4h	Carga solar Solar Charging 54V/7.5A 4-5h	220VAC ± 10%
Pico de salida de CA Peak AC output 6000W	1920Wh LiFePO4	Temperatura de funcionamiento Operating Temp. -10°C - 60°C	Temperatura de almacenamiento Storage Temp. 0°C - 45°C
50/60 Hz	2W(x2) LED	USB-DC 5V/9V/ 12V/3A	DC/DC 12V/10A
USB-Type-C 5V/5A 9V/3A 12V/1.5A	USB 5V 2.4A*2	12V 10A	Universal
CC-CA	MPPT	390mm	418mm
		245mm	



GENERADOR DE ENERGÍA PORTÁTIL

ENERGÍA EN CUALQUIER PARTE



INCLUYE:



Cargador de batería



Cargador placa solar



Cable conector cargador de pared

AMPLIA GAMA DE APLICACIONES



3000W
+0,75h



2000W
+1h



1500W
+1h



1000W
+1,5h



120W
+12h



200W
+7,5h



70W
+22h



30Wh
+50 veces



10Wh
+150 veces



100W
+15h



20W
+7,5h



2200W
+1h



500W
+3h



500W
+3h



2000W
+1h

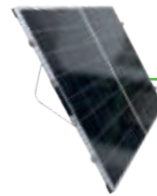

COMPATIBLE CON **53971**

PANEL SOLAR 200W PARA 53970

53971 468,00€

13,45 - 2 12
Kg SUB

200W

Abierto:

884mm 1320mm 54mm

Cerrado:

884mm 659mm 54mm

41.82°

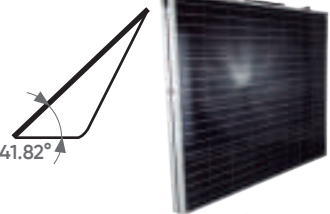

ALTA CONVERSIÓN DE ENERGÍA



FÁCIL DE TRANSPORTAR
FÁCIL INSTALACIÓN

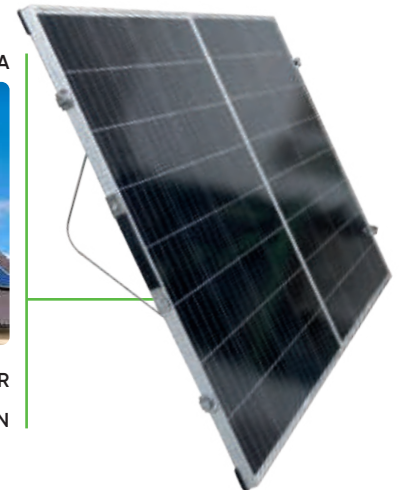

SET DE 2 CONECTORES

MC4 1000V 30A

15448

5,50€



PANEL SOLAR 550W

54067 599,00€

29,00 - 1 31
Kg SUB

550W

2279mm 1134mm 35mm

ESPECIFICACIONES MECÁNICAS

Tipo de celdas:
Monocristalina (Tipo-P), 182x91mm
Número de celdas: 144 (6x24)
Número de Bus Bar por célula fotoeléctrica: 10 Bus Bar
Vidrio: 3.2mm de alta transmisión, revestimiento antirreflejante

ESPECIFICACIONES DE FUNCIONAMIENTO

Voltaje máximo del sistema:
1000 V/1500V DC
Temperatura de funcionamiento:
-40~+85°C
Capacidad máxima de los fusibles en serie: 25A

Cable de salida (conector incluido):
Diámetro: 4.0mm2
Longitud: 300/400mm (longitud personalizable)
Caja de conexiones:
IP68, 3 diodos de Bypass
Conector: Compatible con MC4

Carga de nieve, lado frontal:
5400Pa
Carga de viento, parte trasera:
2400Pa
Temperatura nominal de funcionamiento de la celda: 45°C±2°C
Nivel de aplicación: Clase A

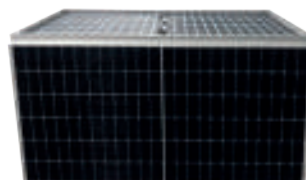
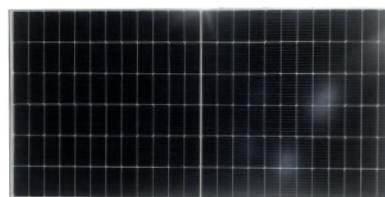

ESPECIFICACIONES ELÉCTRICAS STC

Potencia máxima: 550W
Voltaje de circuito abierto: 50.2V
Potencia máxima de voltaje: 42.4V
Corriente de circuito corto: 13.78A
Potencia máxima de corriente: 12.97A
Eficiencia del módulo: 21.28%

ESPECIFICACIONES ELÉCTRICAS NOCT

Potencia máxima: 409W
Voltaje de circuito abierto: 47.1V
Potencia máxima de voltaje: 39.8V
Corriente de circuito corto: 11.13A
Potencia máxima de corriente: 10.29A

Contacta con nosotros en solar@jbmcamp.com

para obtener estudios, informes, presupuestos e información técnica.



COCHE ELÉCTRICO



Híbridos y eléctricos

CABLES DE CARGA

54053	248,00€	2.15 Kg	1 SUB	1	102
54054	268,00€	2.90 Kg	1 SUB	1	102
54055	220,00€	2.15 Kg	1 SUB	1	102
54056	260,00€	2.85 Kg	5 SUB	5	102
54057	248,00€	2.95 Kg	5 SUB	5	102
54058	348,00€	3.85 Kg	1 SUB	1	102

16A	3.6 kW	Tipo 1 - 2	Monofásico Single-Phase
32A	7.5 kW	Tipo 1 - 2	Monofásico Single-Phase
16A	3.6 kW	Tipo 2 - 2	Monofásico Single-Phase
16A	11 kW	Tipo 2 - 2	Trifásico Three-Phase
32A	7.5 kW	Tipo 2 - 2	Monofásico Single-Phase
32A	22 kW	Tipo 2 - 2	Trifásico Three-Phase



IP 66	5m	-25° +55°	Tipo 1 - 2	IP 66	5m	-25° +55°	Tipo 2 - 2
-------	----	--------------	------------	-------	----	--------------	------------

ESTACIÓN DE CARGA PORTÁTIL

54059	428,00€	2.55 Kg	5 SUB	5	102
16A	3.68 kW	Tipo 2	IP 66	6m	-25° +55°



TARJETA RFID

15460	5,00€	0.01 Kg	250
--------------	-------	---------	-----

TARJETA RFID PARA 54265

16198	5,00€	0.01 Kg	1
--------------	-------	---------	---



CARGADOR DE PARED

52600	884,00€	4.65 Kg	4 SUB	4	80
52902	970,00€	4.90 Kg	4 SUB	4	40
52903	1.100,00€	5.25 Kg	1 SUB	1	40
54052	1.100,00€	5.60 Kg	1 SUB	1	80



CARGADOR DE PARED 22 KW, 32 A, PARA COCHE ELÉCTRICO (TRIFÁSICO)

54265	1.290,00€	5.35 Kg	1 SUB	1	120
32A	22 kW	Tipo 2	Trifásico Three-Phase		



MEDIDOR DE CORRIENTE PARA CARGADOR 54265

16130	290,00€	0.40 Kg	15
--------------	---------	---------	----

Con este accesorio el cargador 54265 está capacitado para regular su potencia de carga calculando el total consumido por el resto de electrodomésticos de la instalación doméstica; evitando sobrecargas y cortes en la red doméstica.



POSTE DE PLÁSTICO PARA CADENA ESPECIAL ALTA TENSION

53940 13,20€

0,55 - 6 96
Kg SUB fff

- De PVC.
- Franjas amarillas y negras.



BASE RELLENABLE DE AGUA O ARENA

850mm



CADENA NO INCLUIDA

- ✓ Para un vallado sencillo, rápido y móvil de zonas interiores y exteriores.
- ✓ Sus colores contrastantes hacen la cadena altamente visible para restringir áreas.



ESLABÓN DE ENCAJE NEGRO

53942 0,50€

0,01 50 5000 75000
Kg SUB fff



CADENA DE PLÁSTICO

53941 6,05€

0,30 - 40 600
Kg SUB fff

- Longitud: 5m
- Eslabón: 6mm
- Color: Amarillo / Negro

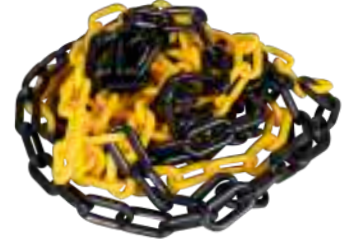

CINTAS DE BALIZAMIENTO 200M

53987 9,50€

0,59 - 40 560
Kg SUB fff



200M X 10cm



PINZA AMPERIMÉTRICA

52382 19,50€

0,23 5 50 1600
Kg SUB fff



52952 74,00€

0,26 5 50 1500
Kg SUB fff



55mm
167mm
22mm

MULTÍMETRO DIGITAL

50942 28,00€

0,35 10 60 480
Kg SUB fff

- Datos instantáneos.
- Autoapagado.
- Indicador de batería.
- Baterías de 9V.
- Sonda de temperatura.
- Temperatura de -40°C a 1000°C.

V AC	200mV, 2V, 20V, 200V, 1000V	A AC	20mA, 200mA, 20A
V DC	200mV, 2V, 20V, 200V, 750V	A DC	20mA, 200mA, 20A
Ω	200Ω, 2KΩ, 20KΩ, 200KΩ, 2MΩ, 20MΩ, 2000MΩ		
F	2nF, 20nF, 200nF, 2μF, 20μF, 200μF		



ESTUCHE DE HERRAMIENTAS AISLADAS

53154 462,00€

3,30 - 3 72
Kg SUB fff

CrV 3/8" 20 PCS



420mm
80mm
33mm



ESTUCHE DE HERRAMIENTAS AISLADAS

54091 441,00€

4,20 - 3 72
Kg SUB fff

1000V C IEC 60900 CrV 3/8" 26 PCS



125mm	x1	200mm	x1	72	x1	3/8"
ALICATE CORTE DIAGONAL	x1	PHILIPS VDE 1x80mm, 2x100mm	x4	ALICATE UNIVERSAL	x1	
		200mm	x1	7x8 6mm, 8x99mm, 10x109mm, 12x127mm, 14x141mm, 17x156mm	x6	
					x1	200mm

ESTUCHE CON 50 DESTORNILLADORES AISLADOS

52521 125,00€

1.43 - 6 216

Kg SUB ITT

CrV 50 PCS

AC 1000V IEC 60900:2004

x9	T6x100 T8x100 T9x100 T10x100 T15x100 T20x100 T25x100 T27x100 T30x100	x7	0.4x2.0x100 0.4x2.5x100 0.5x3.0x100 0.6x3.5x100 0.8x4.0x100 1.0x5.5x100 1.2x6.5x100	x5	H2.5x100 H3.0x100 H4.0x100 H5.0x100 H6.0x100
	x4		4x100 6x100 8x100 10x100		TRI 1x100 TRI 2x100 TRI 3x100 TRI 4x100
x4		x4	TORO 4x100 TORO 6x100 TORO 8x100 TORO 10x100	x3	PZ0x100 PZ1x100 PZ2x100
x2	6.3x89 8.1x89	x2	R1x100 R2x100	x3	M4x4.0x100 M5x5x100 M6x5.0x100
				x1	89



Voltage Tester: 3.0x70 +
Torx: 31x105

CONJUNTO DE PUNTAS Y DESTORNILLADOR ELÉCTRICAMENTE AISLADOS HASTA 1000V

52009 36,00€

0.34 10 50 1200

Kg SUB ITT

AC 1000V IEC 60900:2004

x2 PH1x100, PH2x100

x5 0.4x2.5x100, 0.8x4.0x100, 1.0x5.5x100, 1.2x6.5x100

SET DE 7 DESTORNILLADORES AISLADOS 1.000V

52519 25,50€

0.14 5 10 840

Kg SUB ITT

AC 1000V IEC 60900:2004

CrV

x2 PH00x50, PH0x50mm

x5 SL1.5x0.23x50, SL1.8x0.30x50, SL2.0x0.40x50, SL2.5x0.40x50, SL3.0x0.50x50mm

SET DE 8 DESTORNILLADORES AISLADOS VDE EN MÓDULO EVA FIBRA DE CARBONO

15162 30,20€

0.65 - 10 240

Kg SUB ITT

VDE 8 PCS

VDE

x2 PH 0x75mm
PH 1x80mm
PH 2x100mm

x5 SL 3x75mm
SL 4x100mm
SL 5.5x125mm
SL 6.5x150mm

140mm
SL 0.5 x 3.0 mm
1000V

CUCHILLOS AISLADOS

RECTO

53164 16,50€

0.10 6 36 1152

Kg SUB ITT

VDE 1000V C IEC 60900

Certificate EN60900

180mm

50mm

CrV

CURVADO

53165 19,60€

0.10 6 36 1152

Kg SUB ITT

MEDIDOR DE AISLAMIENTO

54114 248,00€

1.48 - 10 100

Kg SUB ITT

Este instrumento le permite medir el aislamiento eléctrico a una tensión eléctrica determinada (250V, 500V o 1000V). Es una herramienta imprescindible para poder evaluar la integridad del aislamiento de un circuito eléctrico, especialmente necesaria para comprobar que los componentes e instalación en los coches eléctricos están completamente aislados de la carrocería. En instalaciones industriales, es la herramienta que permite realizar comprobaciones periódicas de la resistencia de aislamiento. Mediciones que son exigidas por la norma DIN VDE 0105-100 (VDE 0105-100):2009-10. Está especialmente indicado para la utilización en vehículos eléctricos y híbridos.

Categoría de instalación:	2	Resistencia de aislamiento:	0 - 200MΩ / 200 - 2000MΩ
Categoría de medición:	CAT III	Velocidad de muestra:	2.5 veces por segundo
Altitud:	Hasta 2000 metros	Ajuste cero:	Ajuste automático
Pantalla:	LCD con doble lectura	Temperatura de trabajo:	0° - 40°C (32°F - 104°F), humedad relativa inferior al 80%
Voltaje AC:	0 - 750V	Temperatura de almacenamiento:	-10°C - 60°C (14°F - 140°F), humedad relativa inferior al 70%
Voltaje DC:	0 - 1000V	Fuente de potencia:	9V corriente continua (6 pilas "AA" de 1.5V)
Resistencia:	0 - 200Ω / 200 - 2000 Ω	Tamaño (largo x ancho x alto):	200 x 92 x 50mm



CARRO DE HERRAMIENTAS 7 CAJONES ESPECIAL VDE

54233 1.856,00€ **54234** 1.856,00€ **54235** 1.856,00€ **54236** 1.856,00€

67.70	-	1	4
Kg	Sub	ff	ff

67.70	-	1	4
Kg	Sub	ff	ff

67.70	-	1	4
Kg	Sub	ff	ff

67.70	-	1	4
Kg	Sub	ff	ff

Carro especialmente configurado para cubrir todas las necesidades básicas derivadas del mantenimiento y reparación de vehículos híbridos y eléctricos, así como para trabajos en alta tensión.

TERMÓMETRO LÁSER
-50° a 550°C

52162 38,00€



POSTE DE PLÁSTICO PARA CADENA - AMARILLO/NEGRO

53940 13,20€



x4

CADENA DE PLÁSTICO AMARILLA / NEGRA - 5M

53941 6,05€



x4

ESLABÓN DE ENCAJE NEGRO

53942 0,50€



x8

GUANTES AISLANTES PARA TRABAJOS EN TENSIÓN T.9

54130 58,00€



PÉRTIGA DE SALVAMENTO AISLADA - 45KV

54241 120,00€



MÓDULO EVA DE HERRAMIENTAS AISLADAS VDE 26 PIEZAS

54093 441,00€



MEDIDOR DE AISLAMIENTO

54114 248,00€



ALFOMBRA AISLANTE CLASE 0

54129 110,00€



GUANTES AISLANTES PARA TRABAJOS EN TENSIÓN

54130 58,00€ **T.9** **54131** 58,00€ **T.10**

0.35	-	1	100
Kg	Sub	ff	ff

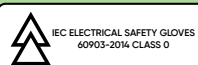

1000V AC - 1500V DC

AZC

LATEX

360mm



CLASS 0 / CLASE 0



ALFOMBRA AISLANTE CLASE 0

54129 110,00€

2.10	-	5	200
Kg	Sub	ff	ff



0,6x1m

2mm

1,8KG



1000V AC - 1500V DC



CLASS 0 / CLASE 0



PÉRTIGA DE SALVAMENTO AISLADA - 45KV

54241 120,00€

1.10	-	1	50
Kg	Sub	ff	ff

Ø 3cm 165cm 37cm

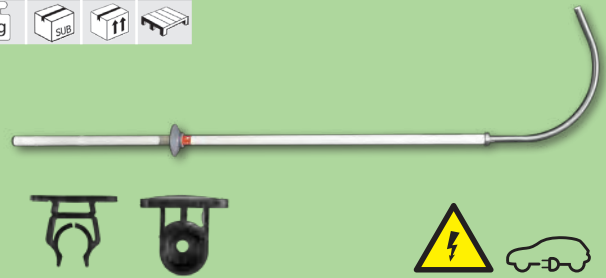

PANTALLA FACIAL AISLANTE PARA TRABAJOS EN TENSIÓN

54132 190,00€

0.70	-	1	62
Kg	Sub	ff	ff

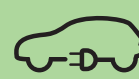

EN 166 : 2001
EN 170 : 2002
ANSI Z87.1



Class 1 class





ACCESORIOS

- 292 CARRETES
- 293 ESCALERAS
- 294 CARROS
- 295 ORGANIZADORES
- 296 PARA COCHE
- 298 KITS DE EMERGENCIA / BOTIQUINES
- 305 SENSORES DE APARCAMIENTO
- 306 ALFOMBRILLAS
- 307 ESCOBILLAS LIMPIAPARABRISAS
- 308 CONTRAPESAS
- 309 VÁLVULAS TPMS
- 310 PARA NEUMÁTICOS
- 314 FUELLE PALIER TURISMO UNIVERSAL
/ HERRAMIENTA NEUMÁTICA PARA EL
MONTAJE DE FUELLES DE PALIER

CARRETE DE MANGUERA DE AGUA

53872 118,00€

7,50	-	1	21
Kg	Sub	ft	ft

- Boca de 3/4".
- Con repartidor.
- Manguera de 15+1,5m.
- Diámetro de la manguera: 1/2"
- Diámetro interno: 11,5mm
- Diámetro externo: 15,8mm
- Presión de trabajo: 120 psi / 8 bar
- Material de la manguera: PVC.



CONECTOR DE MANGUERA RÁPIDO 1/2"

15153	2,50€		
0,05	-	50	-
Kg	Sub	ft	ft

BOQUILLA DE RIEGO

15154	7,50€		
0,05	-	50	-
Kg	Sub	ft	ft

CARRETE DE MANGUERA DE AIRE

VER PÁG. 146

53582 179,00€

10,85	-	1	14
Kg	Sub	ft	ft

22M

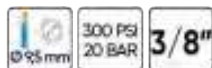

53583 170,00€

10,75	-	1	14
Kg	Sub	ft	ft

53532 119,00€

6,80	-	2	30
Kg	Sub	ft	ft

13M



53581 115,00€

6,70	-	2	30
Kg	Sub	ft	ft

53881 79,00€

4,50	-	4	48
Kg	Sub	ft	ft

11 M



53882 79,00€

4,50	-	4	48
Kg	Sub	ft	ft

11 M

CARRETE DE CABLE ELÉCTRICO

53585 168,00€

8,35	-	2	34
Kg	Sub	ft	ft



21M



53586 158,00€

8,35	-	2	30
Kg	Sub	ft	ft

53526 168,00€

5,15	-	4	48
Kg	Sub	ft	ft

12M



53584 119,00€

5,10	-	4	48
Kg	Sub	ft	ft

CARRETE DE MANGUERA PARA ACEITE

50797 490,00€

26,60	-	1	14
Kg	Sub	ft	ft

160 BAR

Carrete para tubo de aceite
Longitud de la manguera:
15+1m
Presión máxima de trabajo:
2450 PSI
Entrada: 1/2" BSPT
Salida: 1/2" BSPT
Material: Acero



IVA no incluido

ESCALERA MULTIPOSICIÓN

54176 188,00€



150Kg

CONTIENE

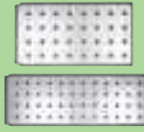

SET DE DOS PLATAFORMAS

15866 32,00€



ESCALERA TELESCÓPICA

51982 120,00€



↑ 2.000mm
↓ 730mm
6 Pasos

51984 190,00€

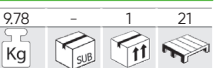

↑ 3.800mm
↓ 1.020mm
12 Pasos

CUMPLE CON: EN 131

51983 180,00€

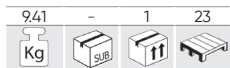

↑ 3.200mm
↓ 930mm
10 Pasos

51982

51983

51984

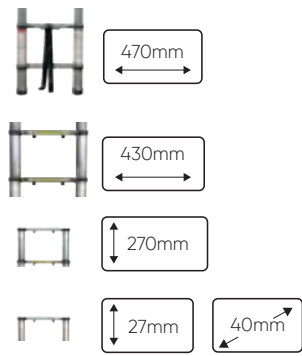

ESCALERA TELESCÓPICA EN "V" PLEGABLE

52149 230,00€



- Escalera plegable y ligera.
- Sistema de plegado mediante bloqueo.
- Fabricada en aluminio y plástico.

- Altura plegada: 835mm.
- Altura extendida: 3800mm.
- Altura total: 1900mm.

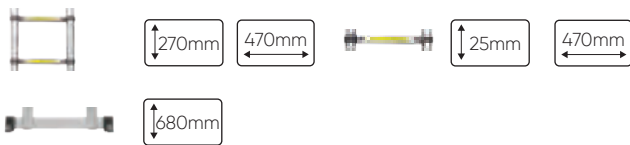

CUMPLE CON: EN 131



ESCALERA DE ALUMINIO

50517 129,00€

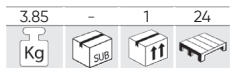

- 4 PELDAÑOS
- Altura total: 1,30m.
- Altura máx. trabajo: 0,79m.



50518 169,00€

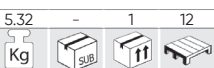



- 6 PELDAÑOS
- Altura total: 1,91m.
- Altura máx. trabajo: 1,31m.



IVA no incluido

BALANZA DE PRECISIÓN

54246 104,00€ 2.27 - 10 400 Kg SUB 0°C 40°C 220V G/LB CT/OZ 5,0kg PRECISIÓN 0,1g CONVERSIÓN DE UNIDADES BATERIA ULTRA DURACION	Inox 304 	54247 99,00€ 2.40 - 8 400 Kg SUB 0°C 40°C 220V G/LB CT/OZ 2,0kg PRECISIÓN 0,01g PROTECTOR PRECISIÓN CONVERSIÓN DE UNIDADES BATERIA ULTRA DURACION	
--	--	---	---

CARRO DE ALUMINIO

52201 66,00€ 6.18 - 4 36 Kg SUB PLEGADO 700mm 400mm 200mm EXTENDIDO 1.060mm 380mm 400mm PLEGABLE Y EXTENSIBLE	90Kg 
---	---

CARRO DE ACERO BÁSICO

52202 88,00€ 9.35 - 1 12 Kg SUB 110mm 450mm 500mm RODAMIENTOS INTERIORES RUEDA 3.00-4 (260x85) PARA REF. 52202 - 52661 12055 20,00€ 1.11 10 160 Kg SUB	200Kg 
--	--

CARRO DE PLATAFORMA DE ACERO

52200 88,00€ 7.80 - 1 32 Kg SUB EXTENDIDO 840mm 725mm 475mm PLEGABLE 150Kg		PLEGADO 230mm 725mm 475mm 2 RUEDAS GIRATORIAS
--	---	--

ACCESORIOS DE TALLER

CAJA 24+2 COMPARTIMENTOS

50957 22,00€

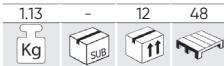
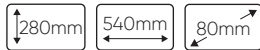

- 24 compartimentos de 8x5,5 cm.
- 2 compartimentos de 15x7,5 cm.
- Abatible de 26 a 5 separaciones.

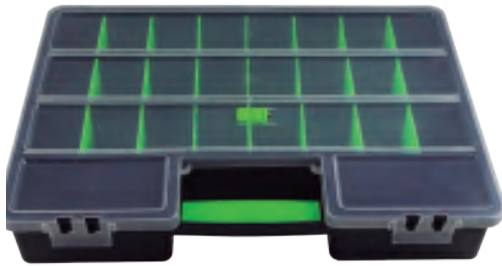

CAJA 18+1 COMPARTIMENTOS

50959 12,00€

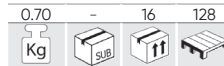
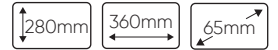

- 18 compartimentos de 6x7 cm.
- 1 compartimento de 35x7 cm.
- Abatible a 4 separaciones.

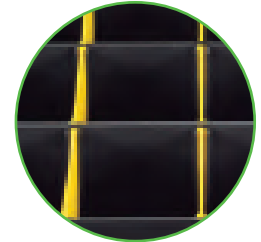

ORGANIZADOR DE 5 COMPARTIMENTOS

51051 34,80€

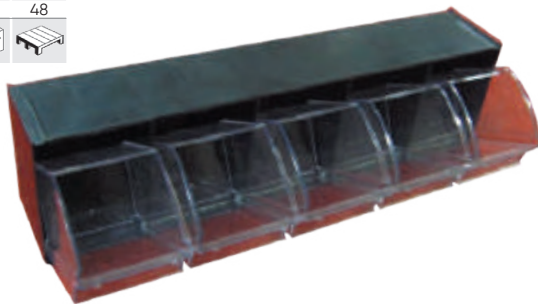
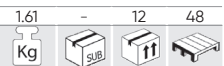

CAJONES INSEPARABLES

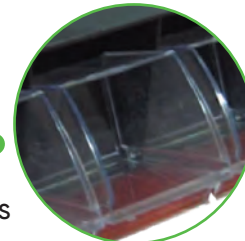

SET DE 8 CAJONES APILABLES CON GUÍA

50960 18,30€



CAJONES



GUÍA

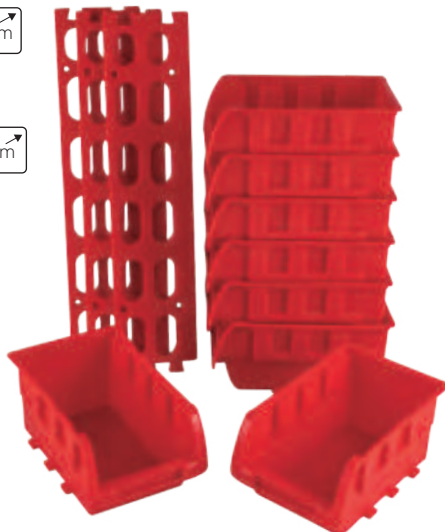

ORGANIZADOR DE PIE 47 COMPARTIMENTOS

51050 285,00€



COMPARTIMENTOS PEQUEÑOS
Total: 32
Medidas: 16x10x7,5 cm
Medidas del estante: 84x16x8 cm
Total estantes: 4

- COMPARTIMENTOS GRANDES
Total: 15
Medidas: 24x14,5x13 cm
Medidas del estante: 84x14x24 cm
Total estantes: 3

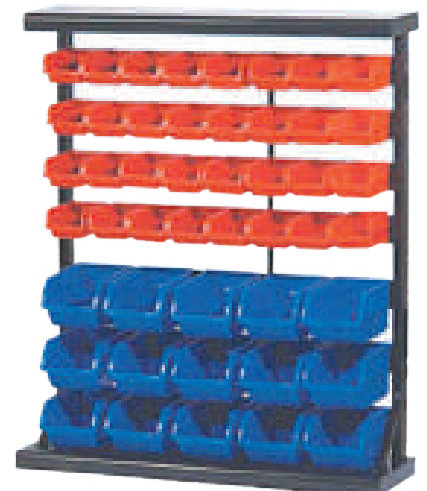

TIENDA DE TECHO RÍGIDA

54180 2.400,00€

100.00	-	1	-
Kg	SUB	11	11

REF.	DESCRIPCIÓN	Kg	SUB	11	€
15905	Juego de tornillos y pernos para tienda	0,15	10	100	16,50€
15906	Juego de placas de instalación para tienda	0,1	10	100	28,50€
15907	Luz para interior tienda	0,3	10	100	12,00€
15908	Soportes de ventana y puerta para tienda	0,95	10	100	14,50€
15909	Barra de soporte para tienda				21,50€
15910	Cortina de entrada para tienda				16,50€

- Material de la carcasa: fibra de vidrio de color blanco. mantiene el interior de la tienda alejado de la temperatura exterior.
- Tejido: poliéster 600d ripstop, resistente al agua, al moho y a los rayos ultravioleta.
- Colchón de espuma de alta densidad con funda lavable; 60mm de grosor
- Escalera telescópica de aluminio
- Mini luz en el interior
- Incluye accesorios de instalación
- Medida interior: 120x208cm



TOLDO PARA COCHE

54185 390,00€

20.00	-	1	-
Kg	SUB	11	11

2000mm 2500mm

Un toldo para vehículos es un accesorio para coches que ayuda a proteger el vehículo del sol, así como a proteger su coche o camión de los fenómenos meteorológicos.

- Contiene:
- Toldo de coche (1)
- Clavija (4)
- Cuerda (2)
- Perno de acero inoxidable de 8 x 20mm (4)
- Soporte en "L" (2)
- Tornillo cuadrado de 8 x 20mm (2)
- Llave inglesa (1)

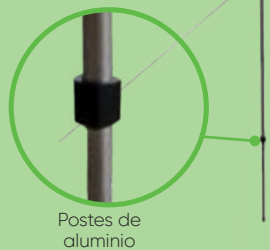

REF.	DESCRIPCIÓN	Kg	SUB	11	€
15911	Soportes para toldo de coche (2 uds.)	0,15	10	100	30,50€
15912	Juego de tornillos y pernos para toldo	0,1	10	100	35,50€
15913	Clavijas para toldo de coche (2 uds.)	0,3	10	100	7,50€
15914	Bolsa y 2 cuerdas para toldo de coche	0,95	10	100	7,50€

SILLA DE COCHE PARA BEBÉ

54196

133,00€

9,15	-	2	24
Kg	Sub	Up	Truck

E24

ECE R44/04

Grupo 1 (9-18kg) orientado hacia delante con sistema de arnés, y equipado con cinturón de seguridad de 3 puntos

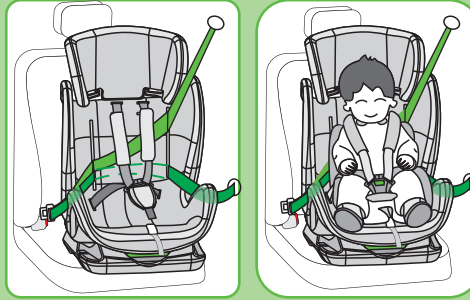

GRUPO 0+ /1/2

Grupo 0+ (0-13kg) orientado hacia atrás con sistema de arnés en la posición más reclinada.

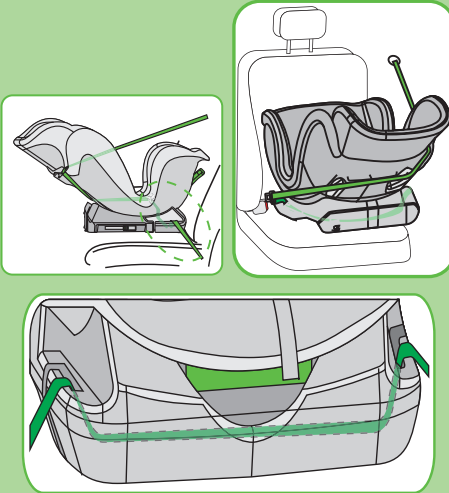

Grupo 2 (15-25kg) orientado hacia delante sin sistema de arnés, equipado con cinturón de seguridad de 3 puntos



- 6 posiciones de reposacabezas
- 3 posiciones de correas de hombro
- 4 posiciones reclinadas
- Fundas de tela extraíbles y lavables

54197

118,00€

6,95	-	4	24
Kg	Sub	Up	Truck

E24

ECE R44/04

GRUPO 1/2/3

Grupo 1 (9-18 kg) orientado hacia delante con sistema de arnés y equipado con cinturón de seguridad de 3 puntos

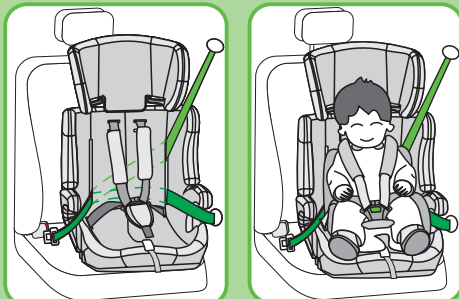

Grupo 2/3 (15-36 kg) orientado hacia delante sin arnés, pero equipado con cinturón de seguridad de 3 puntos



Fundas de tela extraíbles y lavables

ALMOHADILLA DE ALERTA PARA SISTEMA DE RETENCIÓN INFANTIL

54102

60,00€

0,15	-	20	200
Kg	Sub	Up	Truck

Sistema anti abandono con sensores integrados que, colocados en la silla de auto, permiten detectar la presencia del niño a bordo. Los sensores de presión conectados a una aplicación instalada en el smartphone detectan la presencia del niño en la silla de auto y envían una señal de alarma si los padres olvidan al niño en el coche.

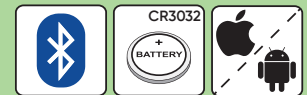
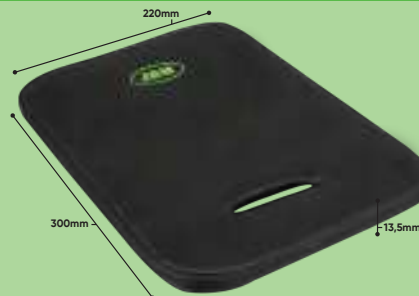

LLAVERO PARA SISTEMA DE ALARMA ANTIABANDONO

15671

20,50€



ESPECIFICACIONES TÉCNICAS

Dimensiones: 220*300*13,5 mm
Peso: 100g
Banda de frecuencia: 24-2485 GHz
Potencia de transmisión: 2,51mw
Alimentación: Batería Cr 3032 (reemplazable)
Temperatura de funcionamiento - 10 °C a + 60 °C
Tejido: Neopreno, Spandex, SBR
Compatible con iOS y Android



KITS DE EMERGENCIA Y SEGURIDAD

CONSULTE PRECIO POR CANTIDADES SERIGRAFÍA Y FOTOLITO NO INCLUIDOS



KIT DE EMERGENCIA EN CAJA PLÁSTICA

53540 23,00€

2,10	-	9	144
Kg		Sub	Paq



2 TRIÁNGULOS DE EMERGENCIA



Personalizable a partir de 50 unidades.



* Doble triángulo, obligatorio solo en España.

BOLSA PARA KIT DE EMERGENCIA CON RIBETE

550 x 90 x 130mm

51692 3,25€

3,25€

51694 3,55€

3,55€

51693 3,55€

3,55€

51696 3,55€

3,55€

0,11	-	100	1200
Kg		Sub	Paq



BOLSA PLANA 550 x 150mm

53624 2,50€

2,50€

53621 2,50€

2,50€

53623 2,50€

2,50€

53622 2,50€

2,50€

0,05	-	100	3200
Kg		Sub	Paq



BOLSA ROJA CON 1 COMPARTIMENTO 565 x 100 x 130mm

51681 4,50€

4,50€

0,17	-	100	700
Kg		Sub	Paq



- En tela 'red' y con cierre de velcro.

BOLSA PARA KIT EMERGENCIA DE PVC

570 x 110 x 65mm

51691 2,40€

2,40€

0,18	-	100	1600
Kg		Sub	Paq

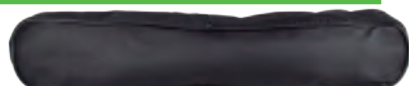

VELCRO



BOLSA NEGRA CON RIBETE ESPECIAL

11328 4,00€

4,00€

0,12	-	100	1200
Kg		Sub	Paq



BOLSA NYLON VERDE ESPECIAL

470 x 65 x 140mm

10945 2,30€

2,30€

0,12	-	100	1600
Kg		Sub	Paq



VELCRO



BOLSA CON 6 COMPARTIMENTOS

570 x 100 x 130mm

51680 2,40€

2,40€

0,28	-	100	800
Kg		Sub	Paq



VELCRO



- En tela 'red' y con cierre de velcro.
- División central con 6 compartimentos.

KIT DE EMERGENCIA BOLSA CON RIBETE



PON TU LOGO

x1

x2

53177	11,90€	53181	11,90€
53178	12,20€	53182	12,20€
53179	12,20€	53183	12,70€
53180	12,20€	53184	12,20€

* Doble triángulo, obligatorio solo en España.

KIT DE EMERGENCIA BOLSA PVC



PON TU LOGO

x1

x2

53185	13,20€	53186	13,20€
-------	--------	-------	--------

* Doble triángulo, obligatorio solo en España.

KIT DE EMERGENCIA BOLSA CON RIBETE



PON TU LOGO

53087	11,20€	53089	11,50€
53088	11,50€	53090	11,50€

KIT DE EMERGENCIA BOLSA PLANA



PON TU LOGO

53091	10,20€	53093	10,30€
53092	10,30€	53094	10,20€

KIT DE EMERGENCIA BOLSA PLANA



H1 (12V)

H4 (12V)

H7 (12V)

* Doble triángulo, obligatorio solo en España.

MK H1		MK H4	
52768	13,80€	52769	14,50€
52772	13,90€	52773	14,60€
52776	13,80€	52777	15,50€
52780	13,90€	52781	14,60€
MK H7		MK H7+H1	
52770	23,00€	52771	23,40€
52774	14,80€	52775	15,20€
52778	14,60€	52779	17,10€
52782	14,80€	52783	15,20€

TRIÁNGULO DE SEÑALIZACIÓN HOMOLOGADO

53778 4,50€

0,35	-	40	1440
Kg	Sub	ff	ff

x1 



CUMPLE CON: E4 27R-032736

52795 5,80€

0,60	1	20	980
Kg	Sub	ff	ff

x1 



CUMPLE CON: E4 27R-032738

CHALECO REFLECTANTE HOMOLOGADO

51817 4,50€

0,13	-	100	2600
Kg	Sub	ff	ff



Banda marcada
CUMPLE CON: EN ISO20471:2013
+A1:2016

50654 4,00€

0,13	-	100	2600
Kg	Sub	ff	ff



Banda marcada
CUMPLE CON: EN ISO20471:2013
+A1:2016

50966 4,00€

0,12	-	100	2600
Kg	Sub	ff	ff



Banda marcada
CUMPLE CON: EN ISO20471:2013
+A1:2016

PONCHO IMPERMEABLE

50525 1,00€

0,05	-	250	6250
Kg	Sub	ff	ff



PISTOLA PARA BOTES DE SPRAY

52493 4,50€

0,06	-	180	2160
Kg	Sub	ff	ff



- Útil accesorio para utilizar con la mayoría de sprays del mercado.

SPRAY REPARA PINCHAZOS

51814 8,00€

0,30	-	12	1260
Kg	Sub	ff	ff

- Para arreglar el pinchazo en menos de un minuto sin necesidad de cambiar la rueda ni desmontarla.



300ml

RASQUETA QUITAHELO

51697 0,80€

0,03	-	300	6000
Kg	Sub	ff	ff



PARAGUAS PLEGABLE

50526 4,80€

0,20	-	100	2000
Kg	Sub	ff	ff



TIJERAS MINI DE 9 cm

51925 1,00€

0,01	100	1000	40000
Kg	Sub	ff	ff



MARTILLO ROMPELUNAS CON SOPORTE Y CORTACINTURÓN

52259 3,75€

0,15	50	100	2400
Kg	Sub	ff	ff



SOPORTE DE MÓVIL PARA COCHE

53443 7,55€

0,05	-	100	5000
Kg	Sub	ff	ff



ENGANCHE 

MANTA TÉRMICA PARA BOTIQUÍN DE PRIMEROS AUXILIOS

15396 2,04€

0,01	-	200	-
Kg	Sub	ff	ff



CE

IVA no incluido

CINTURÓN DE SEGURIDAD PARA AUTOCARES

CINTURÓN DE 2 PUNTOS

CUMPLE CON:
E4-16R-0436213

50644 11,60€

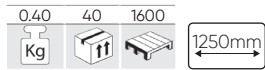

CINTURÓN DE 2 PUNTOS ENROLLABLE

CUMPLE CON:
E4-16R-0436232

50717 21,90€

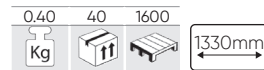

CINTURÓN DE 3 PUNTOS ENROLLABLE

CUMPLE CON: E4-16R-0436232

51266 28,00€

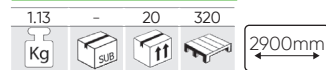

BOLSAS DE PVC CON CREMALLERA

14918 0,23€



14919 0,45€



SET ORGANIZADOR DE MALETERO MULTIFUNCIONAL

52618 29,00€

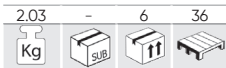

- Set compuesto de 4 piezas:
- Cofre flexible 37L con tapa (300mm x 490mm).
- Bidón circular con tapa Ø 180mm (230mm altura).
- Colgador porta objetos sin tapa (90mm altura x 260mm largo).
- Bandeja rígida (175mm altura x 300mm largo).



SET DE 3 GAMUZAS DE MICROFIBRA

53221 4,75€

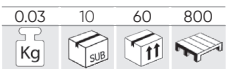

- Set de 3 gamuzas de microfibra, material 100% poliéster de alta calidad.
- Ideales para la limpieza en general (quitar el polvo, desengrasar, repasar pulido...).
- Gran capacidad de absorción de líquidos.
- Sin dejar hilos residuales.



IDEALES PARA LA LIMPIEZA GENERAL DE CUALQUIER VEHÍCULO

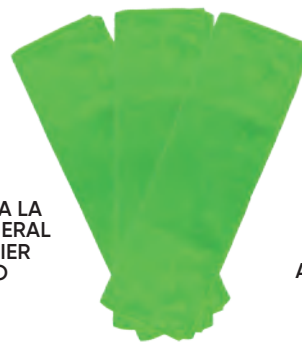

MÚLTIPLES APLICACIONES

GRAN CAPACIDAD DE ABSORCIÓN DE LÍQUIDOS

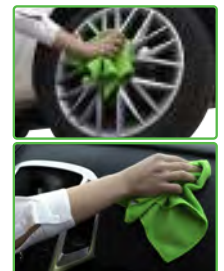

GUANTES DE NITRILO, VINILO, PIEL, ALGODÓN...

VER PÁG. 317



IVA no incluido

JBM

www.jbmcamp.com

301

KIT EMERGENCIA

DISTINTIVO PARA VEHÍCULOS DE TRANSPORTE DE MERCANCÍAS

51935 135,00€

1.04	-	10	280
Kg	sub	ff	

51936 135,00€

1.04	-	10	140
Kg	sub	ff	

50mm 50mm

51937 135,00€

1.02	-	10	280
Kg	sub	ff	



- Aplicación a partir del 10 de Julio de 2011 según modificación del Reglamento General de Vehículos, aprobado por el Real Decreto 2822/1998, de 23 Dic. de 2010.
- Bobinas indivisibles de 50m



HOMOLOGACIÓN:
REGLAMENTO CEPE/ONU 104R

LINTERNA DINAMO DE 2 LEDS

51573 2,50€

0.07	12	96	3456
Kg	sub	ff	



PRESENTACIÓN EN CAJA INDIVIDUAL

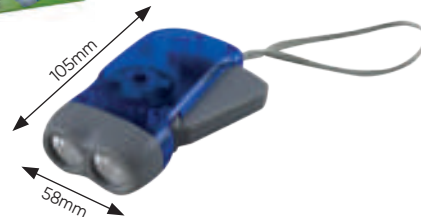

PLACA CARGA SOBRESALIENTE HOMOLOGADA V-20

- Placa para cargas que sobresalen por la parte trasera de cualquier vehículo: camión / furgoneta / turismo / ...
- Con homologación V20.

- Señalización obligatoria en toda Europa para un transporte seguro.
- Medida: 500x500mm.

53636 22,00€

0.45	5	25	750
Kg	sub	ff	

FABRICADA EN POLIPROPILENO PARA UNA MAYOR FLEXIBILIDAD

53507 24,00€

0.75	5	25	800
Kg	sub	ff	

PARTE DELANTERA HECHA DE POLIMETILMETRACRILATO (PMMA) Y PARTE TRASERA DE ALUMINIO

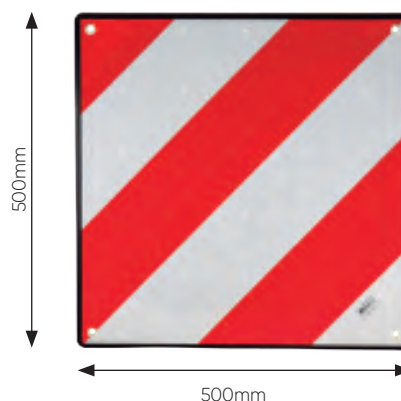
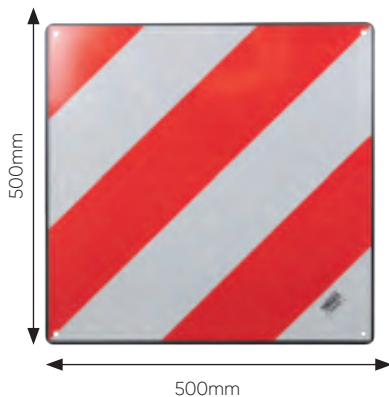

CUÑA DE PLÁSTICO PARA BLOQUEAR RUEDAS

53561 28,00€

1.65	-	4	72
Kg	sub	ff	



- De color amarillo intenso para detectarlo visualmente de manera fácil y rápida cuando se está utilizando.
- **Peso ligero:** fácil de transportarlo y manejarlo.

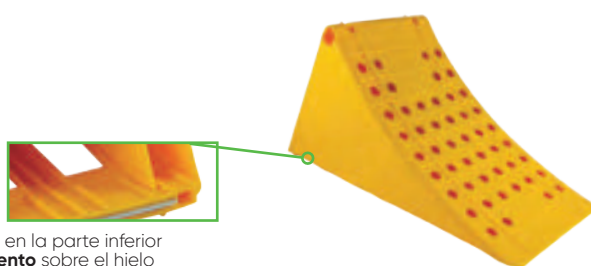
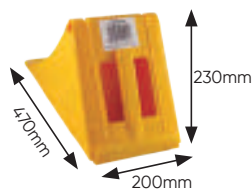

Con una **tira de hierro** en la parte inferior que **evita el deslizamiento** sobre el hielo o arena.



SOPORTE PARA CUÑA DE PLÁSTICO

14118 26,00€

1.25	4	80
Kg	ff	

SET DE 2 CUÑAS PARA VEHÍCULO

53508 14,00€

0.35	4	24	288
Kg	sub	ff	

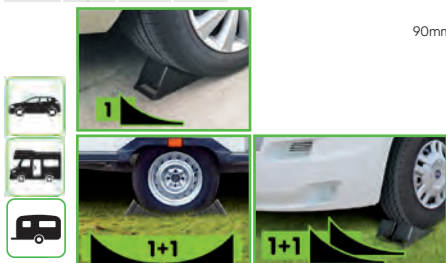

BOTIQUÍN DE PRIMEROS AUXILIOS DIN13164 :2022

54042 13,00€

0,40	-	10	600
Kg	Sub	ff	

Botiquín pequeño y manejable, ideal para coche y trasportarlo con facilidad, presentado en bolsa con cierre cremallera y velcro en la parte posterior.

Contiene:

- 1 Esparadrapo en bobina DIN 13019-A 5x2,5
- 1 Set de 14 unidades que incluye:
 - 4 Vendas adhesivas DIN 13019-E 10x6
 - 2 Tiritas para dedos elásticas 4cmx7cm
 - 2 Tiritas para dedos elásticas 12cmx2cm
 - 2 Tiritas resistentes al agua 1,9x7,2cm
 - 4 Tiritas resistentes al agua 2,5x7,2cm
- 1 Venda esterilizada DIN 13151-K 6x8cm
- 2 Vendas esterilizadas DIN 13151-M 8x10cm
- 1 Venda esterilizada DIN 13151-G 10x12cm
- 1 Paño para heridas DIN 13152-BR 60x40cm
- 1 Paño para heridas DIN 13152-A 60x80cm
- 2 Vendas esterilizadas DIN 61634FB6 6cmx400cm
- 3 Vendas esterilizadas DIN 61634FB8 8cmx400cm
- 1 Manta de primeros auxilios 160x210cm
- 6 Compresas esterilizadas 10x10cm
- 2 Vendajes triangulares DIN 13168-D
- 1 Tijera DIN 58279-A145 145cm
- 4 Guantes desechables DIN EN 455-1
- 2 Toallitas limpiadoras para limpiar la piel
- 1 Listado de contenido
- 1 Guía de primeros auxilios



BOTIQUÍN DE PRIMEROS AUXILIOS DIN13157:2021

54072 38,50€

1,55	-	10	120
Kg	Sub	ff	

Este botiquín de pared incluye los anclajes necesarios para colgarlo en la pared.

Contiene:

- 1x Esparadrapo adhesivo 5x25 - DIN13019-A
- 1x Set de vendas de esparadrapo 10x6cm (8 piezas) - DIN13019-E
- 6x Esparadrapo para dedos 4cmx6,5cm
- 6x Esparadrapo para dedos 120x20mm
- 6x Esparadrapo para dedos 7,2cmx1,9cm
- 12x Esparadrapo para dedos 25x7,2 mm
- 1x Vendas de primeros auxilios, compresa estéril 6x8cm - DIN13151-K
- 3x Vendas de primeros auxilios, compresa estéril 8x10cm - DIN13151-M
- 1x Vendas de primeros auxilios, compresa estéril 10x12cm - DIN13151-G
- 1x Compresa estéril (apósitos para quemaduras) 60x80cm - DIN13152-A
- 3x Apósitos estériles para heridas (compresa) 100mm x100mm 2pcs/bolsa - DIN58953-2
- 2x Compresa ocular - 55mmx75mm 1,5g
- 1x Compresa fría instantánea min.200cm²
- 1x Manta de primeros auxilios 160cmx210cm 12 micras
- 2x Vendajes elásticos en cumplimiento del estándar (gasa) 6cmx400cm - DIN61634 FB6
- 2x Vendajes elásticos en cumplimiento del estándar (gasa) 8cmx400cm - DIN61634 FB8
- 2x Vendas triangulares 96x96x136cm DIN13168-D
- 1x Tijeras de metal 190mm - DIN58279-B190
- 2x Bolsa de plástico para basura 300x400mm 45 micras
- 5x Malla no tejida 20cmX30cm min.15g/m²
- 1x Guantes desechables PVC L-AQL1.5 (juego de 4 piezas) - DIN EN 455-1
- 1x Folleto informativo
- 2x Mascarillas quirúrgicas DIN EN 14683
- 4x Toallitas de limpieza para piel sana



BOTIQUÍN DE PRIMEROS AUXILIOS

51246 6,40€

0,20	-	50	800
Kg	Sub	ff	

- Contiene:

- 1 Folleto primeros auxilios
- 1 Tijeras
- 1 Par de guantes de látex
- 2 Toallitas de alcohol
- 2 Tiritas adhesivas
- 25g de algodón
- 1 Sobre con 5 gasas 20x20cm
- 1 Venda
- 1 Rollo de esparadrapo



PLACA PORTAMATRÍCULA ANÓNIMA

51412 2,10€

0,09	-	100	3000
Kg	Sub	ff	

- Dimensiones : 53,20cm x 13,70cm.
- Área de marcado: 52cm x 1,60cm.

FOTOLITO Y SERIGRAFÍA NO INCLUIDO

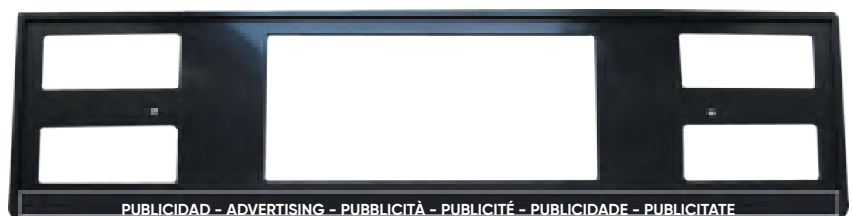

PUBLICIDAD - ADVERTISING - PUBBLICITÀ - PUBLICITÉ - PUBLICIDADE - PUBLICITATE

PALA PLEGABLE

51858

15,00€

- Fabricada con metal resistente.
- Plegada: 240mm.
- Desplegada: 600mm.

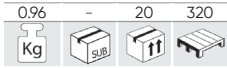

PALA EXTENSIBLE ALUMINIO

53033

21,50€

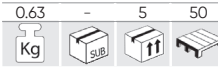

PALA METÁLICA

52187

21,80€

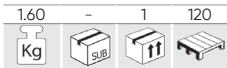

PALA METÁLICA CUADRADA

52251

21,80€

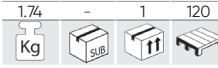

SENSOR DE APARCAMIENTO CON MEDIDOR DE APROXIMACIÓN VISUAL Y ACÚSTICO

51863

54,00€

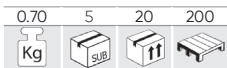

- Voltaje nominal: DC 12 V.
- Potencia: 3,6 W.
- Temperatura de trabajo: -20° a 70°.
- 4 sensores de aproximación.
- Distancia de detección: 0,3-2,0 m.
- Ángulo de detección: H>60°, V>60°.
- Radiofrecuencia: 315 MHz / 433 MHz.
- Incluye indicador de 2 colores de marcado de aproximación.
- Sensores de color negro (no repintables).



SENSOR DE APARCAMIENTO CON MEDIDOR DE APROXIMACIÓN ACÚSTICO

51973

45,00€

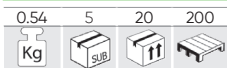

- Voltaje nominal: DC 12 V.
- Potencia: 3,6 W.
- Temperatura de trabajo: -20° a 70°.
- 4 sensores de aproximación.
- Distancia de detección: 0,3-2,0 m.
- Ángulo de detección: H>60°, V>60°.
- Radiofrecuencia: 315 MHz / 433 MHz.
- Sin indicador visual.
- Incluye zumbador de Ø 4cm.
- Sensores de color negro. No repintables.



CUERDA MULTIUSOS 30M

53964

9,65€

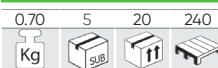

53965

25,80€



SENSOR DE PÁRQUING DE ALARMA 8 PINS

52742

64,00€

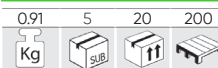

x8

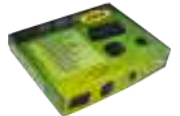

- Delantero + trasero.
- Señal acústica.
- 4 sensores traseros.
- Resistente a lluvias y mal tiempo.
- Piezas de repuesto disponibles.
- Pins repintables.



ALFOMBRILLA DE GOMA UNIVERSAL REVERSIBLE

50585 14,70€

2,86 - 8 208



- Goma de alta calidad.
- Muy resistente.
- Adaptable a la mayoría de vehículos.



EXPOSITOR ALFOMBRAS

METEXP 62,00€

6,00 - 1

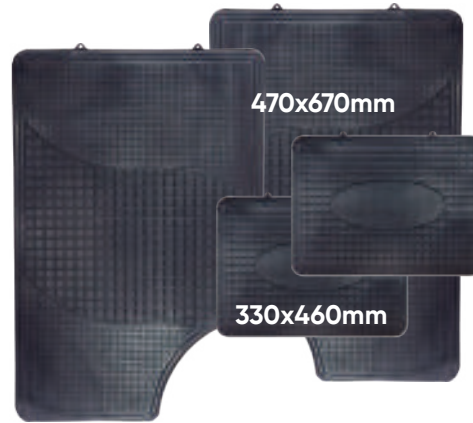

iREVERSIBLE!



ALFOMBRILLA DE GOMA UNIVERSAL

53241 9,00€

1,65 - 12 288



- Goma de alta calidad.
- Muy resistente.
- Adaptable a la mayoría de vehículos.

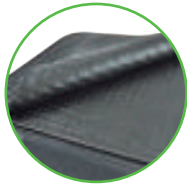

3 PCS



EXPOSITOR ALFOMBRAS

METEXP 62,00€

6,00 - 1



JUEGO DE ALFOMBRILLAS DE MOQUETA

52530 14,00€

2,00 - 8 160



- 2 Delanteras (390mm).
- 2 Traseras (365x480mm).

- Ligera, confortable, con talonera plástica.
- Reverso con tacos de goma antideslizante.



EXPOSITOR ALFOMBRAS

METEXP 62,00€

6,00 - 1



REVERSO



JUEGO DE ALFOMBRILLAS DE MOQUETA

TALONERA PLÁSTICA

52534 15,00€

1,55 - 8 160



- 2 Delanteras (425x660mm).
- 2 Traseras (295x425mm).

- Ligera, confortable, con talonera plástica.
- Reverso con tacos de goma antideslizante.



52534



52535



TALONERA MOQUETA

52535 16,50€

1,55 - 8 160



EXPOSITOR ALFOMBRAS

METEXP 62,00€

6,00 1 25



ESCOBILLA DE LIMPIAPARABRISAS



**FÁCIL
INSTALACIÓN**

**GRAN PODER LIMPIADOR
A GRAN VELOCIDAD**

99%

Fácil instalación de los adaptadores en más del 99% de los vehículos y gran poder limpiador a alta velocidad.

38dB

La ergonomía y la eliminación de partes de peso reduce el ruido en 38db.

30%

Presión uniforme a largo de la escobilla gracias al muelle de acero para una mayor visibilidad que las escobillas originales y un rendimiento superior del 30%.

100%

Caucho 100% natural resistente a todas las condiciones climáticas extremas.

160km/h

Diseño aerodinámico que permite un uso hasta 160km/h.

45°

45° de ángulo de corte y precisión de limpieza transversal que elimina las gotas más pequeñas.

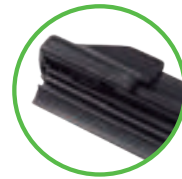

**11 ADAPTADORES
DIFERENTES:
PARA APLICACIONES MÚLTIPLES**



REF.	DESCRIPCIÓN	Kg	Paq	Paq	Paq	Paq	€
53745	11" 280mm	0,20	10	50	800		6,40€
53746	12" 310mm	0,20	10	50	800		6,40€
53747	13" 330mm	0,20	10	50	600		6,40€
53748	14" 350mm	0,20	10	50	800		6,60€
53749	15" 380mm	0,20	10	50	800		6,70€
53750	16" 410mm	0,20	10	50	800		6,70€
53751	17" 430mm	0,20	10	50	550		6,80€
53752	18" 460mm	0,25	10	50	800		6,95€
53753	19" 480mm	0,25	10	50	600		7,10€
53754	20" 510mm	0,25	10	50	600		7,40€
53755	21" 530mm	0,25	10	50	600		7,50€
53756	22" 560mm	0,25	10	50	700		7,90€
53757	24" 610mm	0,25	10	50	550		7,90€
53758	26" 650mm	0,30	10	50	550		8,20€
53759	28" 700mm	0,30	10	50	550		8,50€
53760	30" 750mm	0,30	10	50	500		9,60€



**12
PCS**

EXPOSITOR

JBMW/BEXP 24,50€

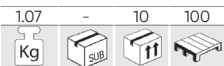

ESCOBILLAS
LIMPIAPARABRISAS

CONTRAPESAS AUTOADHESIVAS EN PASTILLAS DE 45 g. (TIRAS DE 5g - 10g - 5g - 10g - 5g - 10g)

50600 0,60€

0.05 100 400 36000

Kg SUB SUB SUB

ZINC



50601 0,29€

0.05 100 400 48000

Kg SUB SUB SUB

HIERRO



CONTRAPESAS ADHESIVAS 60 g.

52665 0,37€

0.06 100 400 37600

Kg SUB SUB SUB

- Hierro
- Adhesivo de gran agarre y larga duración.

5gr x 12 u.



52666 0,36€

0.06 100 400 37600

Kg SUB SUB SUB

5gr x 4 u.

10gr x 4 u.

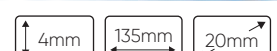

CONTRAPESA DE GRAPA EN ZINC ESPECIAL LLANTA UNIVERSAL

REF.	g.	Kg	Sub	Paq	Paq	€
50760	5g.	0.01	100	1600	80000	0,10€
50761	10g.	0.01	100	1600	102400	0,19€
50762	15g.	0.02	100	800	76800	0,29€
50763	20g.	0.02	100	800	64000	0,38€
50764	25g.	0.03	100	800	48000	0,49€
50765	30g.	0.03	100	600	50400	0,58€
50766	35g.	0.04	100	400	32000	0,68€
50767	40g.	0.04	100	400	25600	0,78€
50768	45g.	0.05	100	400	32000	0,88€
51055	50g.	0.05	100	400	2000	0,98€



CONTRAPESA DE GRAPA EN ZINC ESPECIAL LLANTA ALEACIÓN

REF.	g.	Kg	Sub	Paq	Paq	€
50778	5g.	0.01	100	1600	80000	0,10€
50779	10g.	0.01	100	800	76800	0,19€
50780	15g.	0.02	100	1200	60000	0,29€
50781	20g.	0.02	100	800	80000	0,38€
50782	25g.	0.03	100	800	48000	0,49€
50783	30g.	0.03	100	600	30000	0,58€
50784	35g.	0.04	100	400	32000	0,68€
50785	40g.	0.04	100	400	32000	0,78€
50786	45g.	0.05	100	400	32000	0,88€
51604	50g.	0.05	100	400	2000	0,98€



CONTRAPESA UNIVERSAL CAMIÓN

SEGMENTACIÓN DE 50G

52667 0,76€

0.05 50 400 25600

Kg SUB SUB SUB



SEGMENTACIÓN DE 100G

52668 1,49€

0.10 25 200 12800

Kg SUB SUB SUB



SEGMENTACIÓN DE 150G

52669 2,22€

0.15 20 160 10240

Kg SUB SUB SUB



SEGMENTACIÓN DE 200G

52670 2,95€

0.20 10 80 5120

Kg SUB SUB SUB



SEGMENTACIÓN DE 250G

52671 3,70€

0.25 10 80 5120

Kg SUB SUB SUB



SEGMENTACIÓN DE 300G

52672 4,45€

0.30 10 80 5120

Kg SUB SUB SUB



DISPENSADORES DE CONTRAPESAS AUTOADHESIVAS - PASTILLA DE HIERRO DE 5g

- 1.000 pastillas de 5g de contrapesa de hierro. / Autoadhesiva con 4 mm de espesor. / Medidas del dispensador: 29,5 cm x 29,5 cm.

51908 44,00€

5,60 - 4 - 240

Kg SUB ITT



Con imán de retención de sobrantes

53256 34,00€

5,30 - 4 - 240

Kg SUB ITT



ESTUCHE DE CONTRAPESAS SURTIDO

53864 138,00€

10,50 - 1 - 71

Kg SUB ITT

CONTRAPESAS ADHESIVAS
60gr: 4x10gr 4x5gr - 70u. (ref. 52666)

80mm
540mm
280mm

CONTRAPESAS DE ZINC CON GRAPA

LLANTA UNIVERSAL	LLANTA ALEACIÓN
5g - 20 uds (ref. 50760)	5g - 20 uds (ref. 50778)
10g - 20 uds (ref. 50761)	10g - 20 uds (ref. 50779)
15g - 20 uds (ref. 50762)	15g - 20 uds (ref. 50780)
20g - 20 uds (ref. 50763)	20g - 20 uds (ref. 50781)
25g - 20 uds (ref. 50764)	25g - 20 uds (ref. 50782)
30g - 10 uds (ref. 50765)	30g - 10 uds (ref. 50783)
35g - 10 uds (ref. 50766)	35g - 10 uds (ref. 50784)
40g - 10 uds (ref. 50767)	40g - 10 uds (ref. 50785)



KIT REPARAPINCHAZOS LÍQUIDO Y COMPRESOR DE AIRE

54013 35,00€

1,15 - 5 - 20 - 200

Kg SUB ITT

- Sella pinchazos de hasta 6mm.
- Material no corrosivo para metales ni gomas.
- No inflamable y anticongelante, de gran durabilidad.

LÍQUIDO SELLADOR DE PINCHAZOS - 500ML

15300 5,00€

0,50 - 12 - 936

Kg SUB ITT



EXTRACTOR DE OBUSES

11960 1,50€

0,01 - 10 - 500

Kg SUB ITT



BOLSA PARA KIT

15317 4,50€

0,10 - 500

Kg SUB ITT

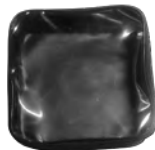

COMPRESOR DE AIRE PORTÁTIL 12V 100W

53150 24,00€

0,55 - 10 - 40 - 640

Kg SUB ITT



COMPRESOR DE AIRE PORTÁTIL

53150 24,00€

120mm 165mm 55mm

0,55 - 10 - 40 - 640

Kg SUB ITT



- DC 12V
- 100W
- 150 PSI 10 BAR
- 10A
- 16L/min
- 30mm

VÁLVULAS TPMS

12902 4,50€

0,01 - 4 - 100 - 1500

Kg SUB ITT

4,25 Nm
OE 72-20-223

12920 7,80€

0,02 - 4 - 100 - 1500

Kg SUB ITT

4 Nm (screw)
4 Nm (nut)

12910 4,40€

0,01 - 4 - 100 -

Kg SUB ITT

75 Nm
OE 72-20-206, TPK65655

12924 4,10€

0,01 - 4 - 100 - 1500

Kg SUB ITT

1,4 Nm (screw)
4,0 Nm (nut)
OE 72-20-116

53723 68,00€

0,05 - 50 - 6000

Kg SUB ITT

EU-PRO HYBRID 3.5

12908 4,50€

0,01 - 4 - 100 -

Kg SUB ITT

4,25 Nm
OE 72-20-205, TPK65654

12923 9,50€

0,01 - 4 - 100 - 1500

Kg SUB ITT

8 Nm
OE TPK43211

12915 12,40€

0,04 - 4 - 100 - 1000

Kg SUB ITT

8 Nm (nut)
1,4 Nm (screw)
OE 72-20-116

12925 10,70€

0,02 - 4 - 100 -

Kg SUB ITT

SET DE REPARACIÓN DE NEUMÁTICOS

52662 36,50€

0,63 - 10 600

Kg SUB

52663 30,00€

1,20 - 10 320

Kg SUB



MECHAS DE RECAMBIO PARA REF. 52662/52663

12973 1,00€

0,01 10 500

Kg SUB

x5

BARRENA DE PERFORACIÓN PARA REF. 52663

13806 10,50€

0,35 5 50

Kg SUB

BARRENA DE INSERCIÓN DE MECHAS PARA REF. 52663

13805 10,50€

0,50 50

Kg SUB

- 1 x Barrena de perforación
- 1 x Barrena de inserción de mechas
- 1 x Util para inflar neumáticos
- 4 x Botellas de aire comprimido 16gr
- 1 x Cúter
- 10 x Mechcas
- 1 x Llave multifuncional obuses

- 1 x Barrena de inserción de mechas
- 1 x Punta para barrena de inserción de mechas
- 1 x Barrena de perforación
- 1 x Cúter
- 20 x Mechcas
- 1 x Lubricante

ÚTIL PARA OBUSES

52653 3,00€

0,03 10 250 6000

Kg SUB

- Para instalar y desinstalar obuses.

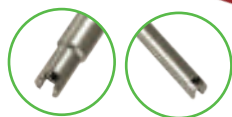

LLAVE MULTIFUNCIONAL OBUSES

52652 2,80€

0,03 25 100 7200

Kg SUB



ALICATES ESPECIAL PARA CONTRAPESAS

51355 19,00€

0,45 5 50 -

Kg SUB



- Extrae fácilmente y sustituye la contrapesa.
- Corta y dobla con facilidad
- Hecho de acero templado.
- Incluye mango ergonómico.

SET DE TAPONES Y OBUSES PARA NEUMÁTICOS

52673 18,00€

0,23 - 25 875

Kg SUB



TAMBIÉN DISPONIBLE

11900 3,50€

Tapón de aluminio para válvula neumático en blister de 4 unidades

11901 2,50€

Tapón de plástico verde para válvula neumático en blister de 4 unidades

11902 3,50€

Tapón de plástico negro para válvula neumático en blister de 4 unidades

CONTIENE

11903 5,00€

Bolsa 16 unidades tapón aluminio para válvula neumático

11905 1,50€

Bolsa 50 unidades tapón plástico negro para válvula neumático

11907 11,00€

Bolsa 50 unidades obuses alta presión

11904 2,00€

Bolsa 50 unidades tapón plástico verde para válvula neumático

11906 8,50€

Bolsa 50 unidades obuses estandar

11960 1,50€

Extracción obuses

KIT DE HERRAMIENTAS PARA MONTAJE Y DESMONTAJE DE VÁLVULAS TPMS

52818 148,00€

1,38 - 10 -

Kg SUB

- Set de herramientas múltiples especialmente diseñadas para facilitar el montaje y desmontaje de los sensores TPMS.
- Dispone de todas las herramientas que el operario necesita para efectuar el cambio de una forma rápida.

- 2-14 NM
- 0,5-3,5 NM
- 2x Ø 11, 12mm
- 3x T10, T15, T20
- 150mm
- 2mm
- 0,25 Nm
- 0,45 Nm

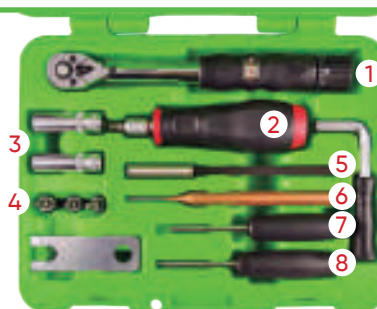

VÁLVULAS PARA LLANTAS

TR413

51741 0,50€

0.01	100	1000	48000
Kg	sub	ff	ff



45mm

TR414

51742 0,50€

0.01	100	1000	48000
Kg	sub	ff	ff



51mm

TR418

51743 0,55€

0.02	100	1000	48000
Kg	sub	ff	ff



64mm

x100

ÚTIL INSTALACIÓN VÁLVULAS NEUMÁTICO

- Para montar válvulas en llantas de vehículos.

METAL

52649 5,00€

3.20	10	50	2250
Kg	sub	ff	ff



PLÁSTICO

52650 5,00€

0.15	10	100	2400
Kg	sub	ff	ff



RODILLO PARA REPARACIÓN DE NEUMÁTICOS

52842 11,00€

0.15	10	100	1500
Kg	sub	ff	ff

38mm



SET DE 3 PROTECTORES DE LLANTAS

53419 9,70€

0.10	10	100	600
Kg	sub	ff	ff

3 PCS



LLAVE EN CRUZ UNIÓN SOLDADA

51661 12,00€

1.17	5	20	480
Kg	sub	ff	ff

355mm

17, 19, 21mm

1/2"



52881 17,00€

1.40	-	10	420
Kg	sub	ff	ff

400mm

17, 19, 21, 22mm

1/2"



52880 42,00€

3.75	-	5	100
Kg	sub	ff	ff

700mm

24, 27, 32mm

3/4"



LLAVE EXTENSIBLE DE RUEDA CON VASOS REVERSIBLES

51416 12,00€

1.05	10	20	600
Kg	sub	ff	ff

330-490mm

1/2"



VASOS CROMADOS

21mm / 23mm

17mm / 19mm



UÑA DE PLÁSTICO RECAMBIO PARA DESMONTADORA DE NEUMÁTICOS

52657 37,50€

0,18	5	20	800
Kg	Sub	ff	ff

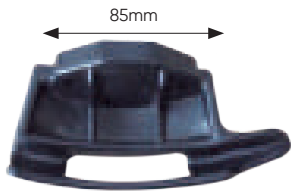

52658 39,70€

0,17	-	20	800
Kg	Sub	ff	ff

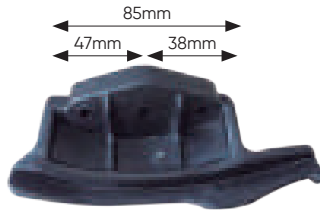

52659 39,70€

0,26	-	20	1920
Kg	Sub	ff	ff



PALANCA PLÁSTICA PARA DESCALZAR NEUMÁTICOS

52655 39,70€

0,39	-	25	1500
Kg	Sub	ff	ff

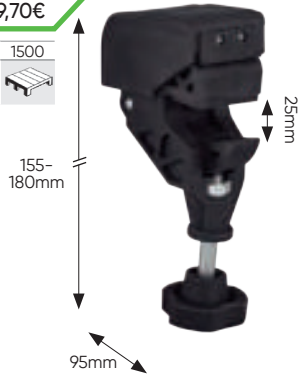

PALANCA PARA EXTRAER NEUMÁTICOS

51362 3,00€

0,15	5	60	500
Kg	Sub	ff	ff

51358 7,50€

0,47	6	24	1008
Kg	Sub	ff	ff

51359 9,00€

0,90	6	30	1440
Kg	Sub	ff	ff

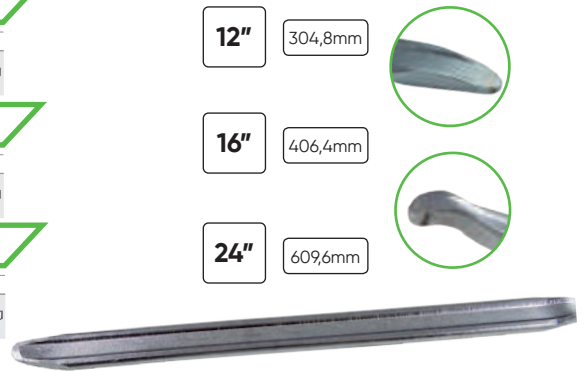

52656 39,50€

0,40	5	20	1920
Kg	Sub	ff	ff



PALANCAS PARA CAMBIO DE NEUMÁTICOS INDUSTRIALES

52664 168,00€

12,30	-	1	15
Kg	Sub	ff	ff

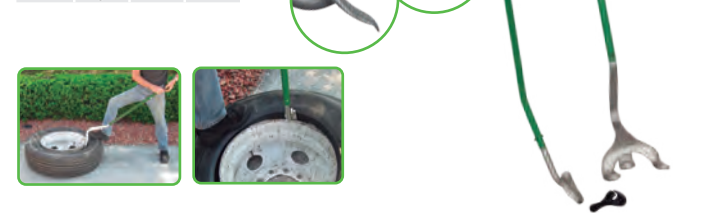

DESMONTADORA DE NEUMÁTICOS MANUAL

53605 141,00€

16,00	-	1	21
Kg	Sub	ff	ff

950mm

1 Manija para interruptor de reborde 37 IN.
Herramienta larga de montaje y desmontaje.

- Capacidad de los neumáticos: Todas las llantas desde 8" hasta las llantas de camiones ligeros (7- 1/2" x 16").
- Neumáticos de flotación: Hasta 12,5L 16.
- Incluye:



PORTADOR DE NEUMÁTICOS

54198 59,00€

4,25	-	1	35
Kg	Sub	ff	ff

CAP. 136kg STEEL PP

66x66x11cm

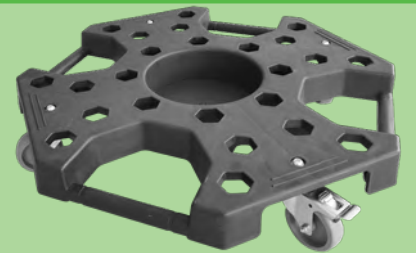

- Cuatro ruedas giratorias de 3" (una bloqueable).
- Asa lateral para facilitar el transporte
- Capacidad de carga: 136 kg
- Dimensiones: 66x66x11 cm
- Peso: 3,4 kg
- Color: negro
- Material de las ruedas: acero + TPR
- Material del cuerpo: plástico

DESMONTADORA DE NEUMÁTICOS MANUAL

54136 107,00€

5,25	-	2	144
Kg	Sub	ff	ff

257mm 162mm 110mm

FOR / PARA



CARRO PORTA NEUMÁTICOS

52660	126,00€	52661	290,00€
7,88	-	1	18
Kg	sub	ff	sub

ALTA CAPACIDAD

200Kg

300Kg

590mm

CALZADORA DE NEUMÁTICOS PORTÁTIL

52552	128,00€		
12,00	-	1	15
Kg	sub	ff	sub

18L

-20°C
40°C

5-8 BAR
(87-116 PSI)

MAX.
10 BAR
145 PSI

BOQUILLA DE RECAMBIO PARA REF. 52552

13741	21,00€		
0,35	-	32	-
Kg	sub	ff	sub

ABRAZADERAS

11891	0,50€	11890	0,55€
0,01	100	5000	90000
Kg	sub	ff	sub

x100

15-45mm

50-125mm

x100

PACK DE 2 ABRAZADERAS

52633	1,00€		
0,02	100	800	14400
Kg	sub	ff	sub

15-45mm

50-125mm

UTILIZAR CON ALICATES REF. 52619

CASQUILLO CENTRADOR

REF.	Kg	sub	ff	sub	€
52645	0,02	50	1.000	38.000	0,55€
52646	0,01	50	1.000	80.000	0,50€
53037	0,01	50	1.000	-	0,50€
53038	0,01	50	1.000	35.000	0,50€
53039	0,02	50	1.000	35.000	0,50€
53040	0,01	50	1.000	35.000	0,50€

52645

22mm

Ø25mm

2,5mm

52646

12mm

Ø25mm

2mm

53037

12mm

Ø23mm

2,5mm

53038

12mm

Ø21mm

2,5mm

53039

19mm

Ø25mm

2,5mm

53040

9mm

Ø25mm

2,5mm

TUBOS FLEXIBLES INNERBRAID



REF.	DESCRIPCIÓN	Kg	sub	ff	sub	€
51706	Ø 25mmL x 300mmL	0,35	25	1.500	22,80€	
51707	Ø 45mmL x 100mmL	0,27	25	1.200	9,05€	
51708	Ø 45mmL x 150mmL	0,38	25	-	14,20€	
51709	Ø 45mmL x 200mmL	0,50	25	-	14,70€	
51710	Ø 45mmL x 250mmL	0,65	25	600	17,80€	
51711	Ø 45mmL x 300mmL	0,71	25	-	21,20€	
51712	Ø 50mmL x 100mmL	0,30	25	-	8,65€	
51713	Ø 50mmL x 150mmL	0,45	25	-	13,10€	
51714	Ø 50mmL x 200mmL	0,56	25	-	15,80€	
51715	Ø 50mmL x 250mmL	0,70	25	-	20,30€	
51716	Ø 50mmL x 300mmL	0,83	25	450	23,60€	
51717	Ø 55mmL x 100mmL	0,35	25	-	11,20€	
51718	Ø 55mmL x 150mmL	0,50	25	-	14,80€	
51719	Ø 55mmL x 200mmL	0,65	25	-	22,00€	
51720	Ø 55mmL x 250mmL	0,85	25	350	23,50€	
51721	Ø 55mmL x 300mmL	1,00	25	375	25,00€	
51722	Ø 60mmL x 100mmL	0,36	25	-	13,10€	
51723	Ø 60mmL x 150mmL	0,50	25	-	18,70€	
51724	Ø 60mmL x 200mmL	0,66	25	-	24,40€	
51725	Ø 60mmL x 250mmL	0,83	25	-	28,30€	
51726	Ø 60mmL x 300mmL	0,96	25	250	31,40€	
51727	Ø 60mmL x 400mmL	1,62	25	200	49,00€	

KIT DE FUELLE DE PALIER UNIVERSAL

PARA TURISMO

51705

8,45€

0.23	-	20	400
Kg	sub	ff	ff



PARA FURGONETA

51703

10,50€

0.28	-	20	320
Kg	sub	ff	ff



RECAMBIO PARA REF. 51703

13739

5,50€

0.15	-	100	1600
Kg	sub	ff	ff



RECAMBIO PARA REF. 51705

13738

3,50€

0.08	-	150	2400
Kg	sub	ff	ff



KIT FUELLE DIRECCIÓN UNIVERSAL

52644

8,80€

0.19	-	20	400
Kg	sub	ff	ff

NEOPRENO



BOLSA GRASA FUELLE DIRECCIÓN

13880

1,50€

0.01	-	600	21000
Kg	sub	ff	ff



RECAMBIO PARA REF. 52644

13740

5,50€

0.10	-	72	-
Kg	sub	ff	ff



HERRAMIENTA PARA MONTAJE FUELLES DE PALIER

52829

19,00€

0.45	-	10	200
Kg	sub	ff	ff

EXTERIOR

INTERIOR

Ø 10cm

Ø 9,5cm



HERRAMIENTA NEUMÁTICA PARA MONTAJE DE FUELLES DE PALIER

51861

199,00€

4.00	-	2	32
Kg	sub	ff	ff

- Material: Aluminio.
- Apertura de 20 a 100mm.

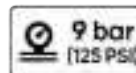

SERIE PROMOCIONAL ESPECIAL FUELLES

SERIE124

710,00€

22.15	-	-	20
Kg	sub	ff	ff

BOLSA GRASA FUELLE TRANSMISIÓN

13879

1,38€

0.09	-	150	5250
Kg	sub	ff	ff



51861 x1

52633 x100

13738 x100

13879 x100

CAJA DE 100 KITS DE FUELLE

53693

521,00€

19.80	-	1	20
Kg	sub	ff	ff



x100

13738



x100

52633



x100

13879

CAJA DE 100 KITS DE FUELLE DE PALIER PARA FURGONETA

53698

717,00€

19.80	-	1	24
Kg	sub	ff	ff



x100

13739



x100

52633



x100

13880

CAJA DE 80 KITS DE FUELLE DE DIRECCIÓN

53695

504,00€

11.25	-	1	24
Kg	sub	ff	ff



x80

13740



x80

52633



x80

13880



SEGURIDAD Y EPIS

- 316 GUANTES / EPIS
- 318 BOTIQUINES
- 319 MASCARILLAS / DISPENSADORES
- 320 CÁMARAS TÉRMICAS / TERMÓMETROS
/DETERGENTES DE SUPERFÍCIES / LIMPIADORES
- 321 DISTANCIA DE SEGURIDAD
- 322 DESINFECCIÓN DE ESPACIOS
/MEDIDOR DE OZONO

GUANTES CON PALMA REFORZADA DE POLIURETANO

REF. 1,54€

0,05	12	144	3456
Kg	sub	ff	ff

51640N T.8

51642N T.9

51636N T.10

51638N T.11



EN 388
3131

CE
CAT - II

GUANTES CON PALMA REFORZADA DE NITRILLO

REF. 1,74€

0,04	12	144	3456
Kg	sub	ff	ff

51633 T.8

51634 T.9

51632N T.10

51398N T.11



EN 388
3121X

CE
CAT - II

GUANTES DE HILO DE ALGODÓN CON LA PALMA REFORZADA DE PUNTITOS

51785 0,75€

0,04	12	300	3600
Kg	sub	ff	ff

51745 0,70€

0,05	12	144	4320
Kg	sub	ff	ff



PALMA REFORZADA

CE

GUANTES DE ALGODÓN

51745 0,70€

0,05	12	144	4320
Kg	sub	ff	ff



CE

GUANTES DE PIEL Y TELA

52310 3,65€

0,20	12	120	1920
Kg	sub	ff	ff



CE

GUANTES DE PIEL

52738 5,00€

0,10	12	144	2304
Kg	sub	ff	ff

T. 9

CE
EN388: 16
2121X



52739 5,00€

0,12	12	144	2304
Kg	sub	ff	ff

T. 10



GUANTES DE TRABAJO

REF. 19,00€

0,15	12	60	2040
Kg	sub	ff	ff

54188 T.8

54189 T.9

54190 T.10

54191 T.11



EN 388
3131

CE

GUANTES DE TRABAJO DE INVIERNO

REF. 8,90€

0,15	12	144	3456
Kg	sub	ff	ff

54192 T.8

54193 T.9

54194 T.10

54195 T.11



CE

EN 511
EN 388
3131

Automoción, Industria, Técnico, Anti-cortes, Anti-cold

GUANTES ANTI-CORTE PANTALLA TÁCTIL

52570 2,60€

0,03	12	144	3456
Kg	sub	ff	ff

T. 8

EN 388
3131X

52571 2,60€

0,03	12	144	2592
Kg	sub	ff	ff

T. 9

EN 388
3131X

52572 2,60€

0,03	12	144	2592
Kg	sub	ff	ff

T. 10

EN 388
4131

52573 2,60€

0,04	12	144	2592
Kg	sub	ff	ff

T. 11

EN 388
4131

PARA PANTALLA TÁCTIL



CE





GUANTES DESECHABLES DE NITRILO

JBM	REF.	DÉSCRIPT ION	Kg	UDS	Paq	Paq	€
	3.5 MIL						
	54294	S	0,40	100	10	500	8,80€
	53984	M	0,50	100	10	400	8,80€
	53985	L	0,50	100	10	400	8,80€
	53986	XL	0,55	100	10	400	8,80€



JBM	REF.	DESCRIPCIÓN	Kg	UDS	Paq	Paq	€
	3.5 MIL						
	54155	M	0,50	100	10	570	8,80€
	54156	L	0,50	100	10	570	8,80€
	54157	XL	0,50	100	10	570	8,80€



JBM	REF.	DESCRIPCIÓN	Kg	UDS	Paq	Paq	€
	5.0 MIL						
	54151	M	0,62	100	10	510	10,90€
	54152	L	0,62	100	10	510	10,90€
	54153	XL	0,67	100	10	510	10,90€



GUANTES DESECHABLES TEXTURA DIAMANTE

JBM	REF.	DESCRIPCIÓN	Kg	UDS	Paq	Paq	€
	7.0 MIL						
	53551	M	0,90	100	10	300	18,95€
	53552	L	1	100	10	300	18,95€
	53553	XL	1	90	10	300	18,95€

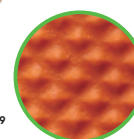

JBM	REF.	DESCRIPCIÓN	Kg	UDS	Paq	Paq	€
	7.0 MIL						
	54177	M	0,90	100	10	300	18,95€
	54178	L	0,90	100	10	300	18,95€
	54179	XL	0,90	90	10	300	18,95€

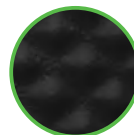

CHALECO CON BANDA REFLECTANTE HOMOLOGADO

51817	4,50€	50966	4,00€	50654	4,00€
0,13	-	0,12	-	0,13	-
100	2600	100	2600	100	2600

Banda marcada

CUMPLE CON:
EN ISO20471:2013



GAFAS DE PROTECCIÓN SPORT - ANTIVAHO

53598 3,95€

53596 3,65€

53597 3,70€



CUMPLE CON: EN166:2002-04 / EN166:2003-01



53596, 53597, 53598



53597

0,01 12 144 2016
Kg SUB ITT

EN EXPOSITOR DE 12 UNIDADES

GAFAS DE PROTECCIÓN ANTIVAHO

53785 4,80€

Conforme a EN166:2002-04

0,05 14 112 896
Kg SUB ITT

- Protección directa frente a líquidos y bacteria.
- Cinta elástica ajustable.
- Tratamiento antivaho en lente.

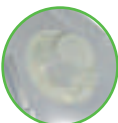

Válvulas incorporadas para mejor ventilación.



AURICULAR PASIVO PARA PROTECCIÓN AUDITIVA

52430 10,90€

0,34 6 24 96
Kg SUB ITT

CUMPLE CON: EN352 - 1:2003



PVC

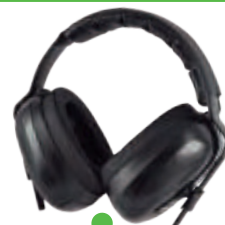

ABS

BOTIQUÍN DE PRIMEROS AUXILIOS DIN13164

54042 13,00€

Botiquín pequeño y manejable, ideal para coche y trasportarlo con facilidad, presentado en bolsa con cierre cremallera y velcro en la parte posterior.

0,40 - 10 320
Kg SUB ITT

Contiene:

- 1 Esparadrado en bobina DIN 13019-A 5x2,5
- 1 Set de 14 unidades que incluye:
 - 4 Vendas adhesivas DIN 13019-E 10x6
 - 2 Tiritas para dedos elásticas 4cmx7cm
 - 2 Tiritas para dedos elásticas 12cmx2cm
 - 2 Tiritas resistentes al agua 1,9x7,2cm
 - 4 Tiritas resistentes al agua

- 2,5x7,2cm
- 1 Venda esterilizada DIN 13151-K 6x8cm
- 2 Vendas esterilizadas DIN 13151-M 8x10cm
- 1 Venda esterilizada DIN 13151-G 10x12cm
- 1 Paño para heridas DIN 13152-BR 60x40cm
- 1 Paño para heridas DIN 13152-A 60x80cm
- 2 Vendas esterilizadas DIN 61634FB6 6cmx400cm
- 3 Vendas esterilizadas DIN 61634FB8

- 8cmx400cm
- 1 Manta de primeros auxilios 160x210cm
- 6 Compresas esterilizadas 10x10cm
- 2 Vendajes triangulares DIN 13168-D
- 1 Tijera DIN 58279-A145 14,5cm
- 4 Guantes desechables DIN EN 455-1
- 2 Toallitas limpiadoras para limpiar la piel
- 1 Listado de contenido
- 1 Guía de primeros auxilios



BOTIQUÍN DE PRIMEROS AUXILIOS DIN13157:2021

54072 38,50€

Este botiquín de pared incluye los anclajes necesarios para colgarlo en la pared.

1,55 - 10 120
Kg SUB ITT

Contiene:

- 1x Esparadrado adhesivo 5x25 - DIN13019-A
- 1x Set de vendas de esparadrado 10x6cm (8 piezas) - DIN13019-E
- 6x Esparadrado para dedos 4cmx6,5cm
- 6x Esparadrado para dedos 120x20mm
- 6x Esparadrado para dedos 7,2cmx1,9cm
- 12x Esparadrado para dedos 25x72 mm
- 1x Vendas de primeros auxilios, compresa esteril 6x8cm - DIN13151-K
- 3x Vendas de primeros auxilios, compresa esteril 8x10cm - DIN13151-M
- 1x Vendas de primeros auxilios, compresa esteril 10x12cm - DIN13151-G
- 1x Compresa esteril (apósitos para quemaduras) 60x80cm - DIN13152-A
- 3x Apósitos esteriles para heridas (compresa) 100mm x100mm 2pcs/bolsa - DIN58953-2
- 2x Compresa ocular - 55mmx75mm 1,5g

- 1x Compresa fría instantánea min.200cm2
- 1x Manta de primeros auxilios 160cmx210cm
- 12 micras
- 2x Vendajes elásticos en cumplimiento del estándar (gasa) 6cmx400cm - DIN61634 FB6
- 2x Vendajes elásticos en cumplimiento del estándar (gasa) 8cmx400cm - DIN61634 FB8
- 2x Vendas triangulares 96x96x136cm DIN13168-D
- 1x Tijeras de metal 190mm - DIN58279-B190
- 2x Bolsa de plástico para basura 300x400mm 45 micras
- 5x Malla no tejida 20cmx30cm min.15g/m2
- 1x Guantes desechables PVC L-AQL1.5 (juego de 4 piezas) - DIN EN 455-1
- 1x Folleto informativo
- 2x Mascarillas quirúrgicas DIN EN 14683
- 4x Toallitas de limpieza para piel sana



BOTIQUÍN DE PRIMEROS AUXILIOS

51246 6,40€

0,20 - 50 800
Kg SUB ITT

- Contiene:
- 1 Folleto primeros auxilios
- 1 Tijeras
- 1 Par de guantes de látex
- 2 Toallitas de alcohol

- 2 Tiritas adhesivas
- 25g de algodón
- 1 Sobre con 5 gasas 20x20cm
- 1 Venda
- 1 Rollo de esparadrado



MASCARILLAS DE PROTECCIÓN AUTOFILTRANTE

FFP2

- Un material de filtración de varias capas: polipropileno.
- Forro interno que mejora la estanqueidad y la comodidad de uso.
- Arco de aluminio para fácil adaptación a la nariz.

- Goma elástica de fácil sujeción.
- Diseño en arco para una respiración más suave.

53787 0,98€

0,01	10	800	6400
Kg	Sub	ff	ff



Penetración del material filtrante	≤ 6%
Fuga total	≤ 11%
Resistencia respiratoria máx.	30l/min (inhalación): ≤ 0.70 mbar 95l/min (inhalación): ≤ 2.4 mbar 160l/min (exhalación): ≤ 3 mbar

Homologada según reglamento UE 2016/425
Cumple con normativa EN149:2001+A1:2009

CON VÁLVULA

53844 2,80€

0,02	3	360	1440
Kg	Sub	ff	ff



Servidos en cajas de 3 unidades

Homologada según reglamento UE 2016/425
Cumple con la normativa EN149:2001

FFP2

53946 0,83€

53961 0,98€

53960 0,98€

537870 0,98€

53959 0,98€



Homologada según reglamento UE 2016/425
Cumple con normativa EN149:2001+A1:2009

Penetración del material filtrante	≤ 6%
Fuga total	≤ 11%
Resistencia respiratoria máx.	30l/min (inhalación): ≤ 0.70 mbar 95l/min (inhalación): ≤ 2.4 mbar 160l/min (exhalación): ≤ 3 mbar

0,01	10	1000	9000
Kg	Sub	ff	ff

FFP3

53916 3,80€

0,03	10	200	1600
Kg	Sub	ff	ff



CON VÁLVULA INCORPORADA

- Material de filtración de 3 capas: polipropileno.
- Una pinza nasal para dar forma a la máscara en zona de la nariz.
- Válvula de exhalación

- Las bandas para la cabeza hechas de hilo de goma trenzado sin látex.
- Cierres de plástico.
- Forro interno que mejora la estanqueidad y la comodidad.

Homologada según reglamento UE 2016/425
Cumple con normativa EN149:2001

Penetración en el material filtrante	≤ 1%
Tiempo máximo de uso	8 horas

DE UN SOLO USO

HIGIÉNICA

53797 0,10€

0,00	50	2000	24000
Kg	Sub	ff	ff

53957 0,26€

0,01	50	2000	24000
Kg	Sub	ff	ff

EFB eficacia a la filtración bacteriana	>98%
Resistencia a la respiración	35-50 Pa

UNE 0064-1:2020



USO NO MÉDICO.



En bolsas de 10 unidades.
Cajas de 50 unidades.

ALFOMBRAS PARA LA LIMPIEZA DE LOS ZAPATOS

ALFOMBRA DESINFECTANTE

CON DEPÓSITO PARA LÍQUIDO

53862 6,00€

1,45	-	5	100
Kg	Sub	ff	ff

- Medidas: 85x55x10cm
- Material: TPE
- Capacidad máxima recomendada: 3L
- Capacidad máxima: 8L



MOQUETA PARA SECADO

53863 3,00€

0,70	-	5	240
Kg	Sub	ff	ff

- Medidas: 76x48cm
- Material: Poliéster

GARRAFA 5L LIQUIDO DETERGENTE P/ALFOMBRA 53862

53893 5,00€

4,30	-	4	128
Kg	Sub	ff	ff



DISPENSADOR DE FUNDAS DE CALZADO

53781 18,00€

2,20	-	8	32
Kg	Sub	ff	ff

- Permite cubrir los pies con fundas de plástico únicamente colocándolos en el interior del dispensador.
- Incluye 8 ventosas de PVC en la base para una mayor sujeción y un juego de 100 fundas.

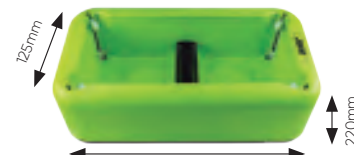

Material: Plástico ABS
100 FUNDAS DE CALZADO

14781 990€

0,25	-	84	336
Kg	Sub	ff	ff



DISPENSADOR AUTOMÁTICO 1200ml

53902 25,00€

1,15	-	18	144
Kg	Sub	ff	ff

- Dosificación: ajustable de 0,7ml a 1,4ml.
- Compatibles con jabón líquido, alcohol, gel y desinfectante de manos.
- Voltaje: 6V 1.5A
- Medidas: 160x120x295mm.
- Material: ABS.



DISTANCIA DE ACTIVACIÓN DEL SENSOR: 8-12CM



ADAPTADOR AC/DC 6V 1.5A

15059 10,00€

0,10	-	200	-
Kg	Sub	ff	ff

PILA R14 C1.5V

15062 1,00€

0,05	24	480	-
Kg	Sub	ff	ff

Incluye soporte y tornillos para fijar en pared.

DISPENSADOR AUTOMÁTICO 400ML

53826 16,00€

0,35	-	40	400
Kg	Sub	ff	ff

- Compatible con jabón líquido, alcohol, gel y desinfectante de manos.
- Sensor infrarrojo de movimiento con luz led.
- Dosificación: 1ml.
- Voltaje: 6V (4 pilas de 1,5V).
- Pilas no incluidas.



DOSIFICADOR PARA GARRAFA

14793 12,00€

0,05	-	100	1200
Kg	Sub	ff	ff



PIE PARA DISPENSADOR DE GEL AUTOMÁTICO

53827 14,00€

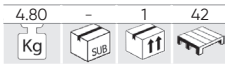

PARA DISPENSADOR

53902 25,00€

- Peso: 4.3kg
- Material: Acero
- Color: Negro
- Medidas de la bandeja: 417x67mm
- Medidas del soporte para el dispensador: 480x133mm
- Diámetro de la base: 395mm

TERMÓMETRO INFRARROJO

53794 28,00€

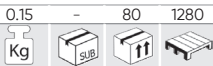

- CON ALARMA DE SONIDO
- CON MEMORIA DE HASTA 32 REGISTROS
- PANTALLA DE FÁCIL VISUALIZACIÓN



distancia de medición: 15 - 50mm



CE 0123
2 pilas AAA

- Mide la temperatura corporal en **1 segundo** y **sin contacto**.
- Apagado automático después de 1 minuto.

Rango de medición 32.0°C - 42.2°C (89.6°F - 108°F)
Precisión ±0.2°C (35°C - 42°C)

BOLSAS DE PVC CON CREMALLERA

14918 0,23€

25 x 30cm

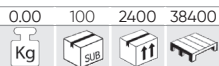

14919 0,45€

60 x 18 cm

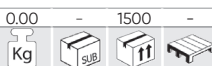

DETERGENTE LIMPIADOR DE SUPERFICIES DURAS

FORMATO LÍQUIDO

FORMATO SPRAY



Limpia todo tipo de superficies: hogar - coche - oficina - AACC

- Spray ideal para limpiar todo tipo de superficies.
- Aspecto físico: Líquido transparente.
- Contiene: Isopropanol / Etanol.



Útil accesorio para utilizar con la mayoría de sprays del mercado.

PISTOLA PARA BOTE DE SPRAY

53829 14,00€



53828 6,00€



53824 2,85€



53804 0,80€



52493 4,50€

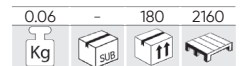

CUIDADO E HIGIENE DE MANOS: LIMPIADORES Y FÓRMULAS HIDROALCOHÓLICAS



- Contiene: propan-2-ol, alcohol isopropílico / propan-1-ol, n-propanol

Modo empleo:

Aplicar sobre la piel sana y seca una cantidad suficiente de producto y frotar durante al menos 30 segundos. No necesita aclarado.

FORMATO GEL

FORMATO LOCIÓN

FORMATO ESPUMA

válidos para superficies

- Solución hidroalcohólica con glicerina y aloe vera para la higiene y el cuidado de las manos.



53832 1,81€

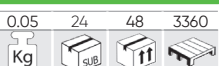

53791 4,80€



53822 2,50€

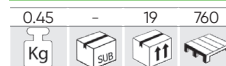

53803 0,90€

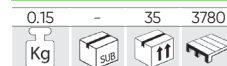

MÁSCARA DE PROTECCIÓN ANTIVAHU

53798 1,95€

Conforme a EN166



Protección directa frente a líquidos y bacteria.

- Espuma en la parte interior para mejorar la comodidad.
- Tratamiento antivaho en pantalla.
- Ajustable.



CÁMARA CON SISTEMA DE MEDICIÓN DE TEMPERATURA

53830 1.300,00€

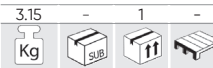

Potencia: 12VDC

Relay: +:NO -:COM

Internet: RJ45



Funciona mediante conexión IP



Software de monitorización incluido



VIDEOTUTORIAL DISPONIBLE EN YouTube

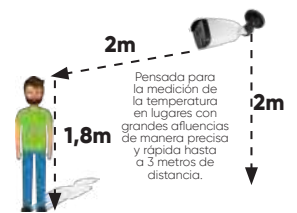

Pensada para la medición de la temperatura en lugares con grandes afluencias de manera precisa y rápida hasta a 3 metros de distancia.

PROTECTORES DE METACRILATO

53835 16,00€

2.30	-	5	80
Kg	Sub	ff	ff



53836 16,00€

4.05	-	5	60
Kg	Sub	ff	ff

Grosor: 5mm
Agujero: 300x160mm
Base: 150x200mm

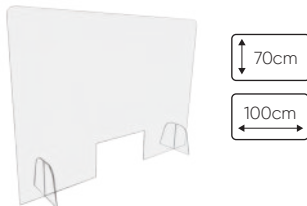

CINTAS DE SEÑALIZACIÓN 200M

53811 8,90€

0.45	-	40	560
Kg	Sub	ff	ff



53987 0.59
9,50€

0.59	Kg
------	----

200M X 10cm

POSTE DE PLÁSTICO PARA CADENA ESPECIAL ALTA TENSIÓN

53940 13,20€

0.55	-	6	96
Kg	Sub	ff	ff

- De PVC.
- Franjas amarillas y negras.



ESPECIAL SEÑALIZACIÓN ALTA TENSIÓN

CADENA NO INCLUIDA

- ✓ Para un vallado sencillo, rápido y móvil de zonas interiores y exteriores con limitaciones.
- ✓ Sus colores contrastantes hacen la cadena altamente visible para restringir áreas de alta tensión.



BASE RELLENABLE DE AGUA O ARENA

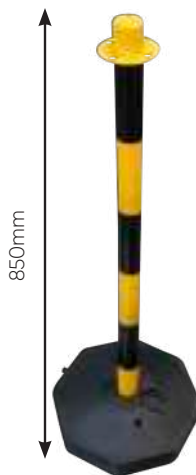

ESLABÓN DE ENCAJE NEGRO

53942 0,50€

0.01	50	5000	75000
Kg	Sub	ff	ff



CADENA DE PLÁSTICO

53941 6,05€

0.30	-	40	600
Kg	Sub	ff	ff

- Longitud: 5m
- Eslabón: 6mm
- Color: Amarillo / Negro

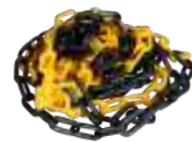

POSTE DE PLÁSTICO PARA CADENA

53808 16,50€

0.55	-	6	114
Kg	Sub	ff	ff

- De PVC.
- Franjas blancas y rojas de 130mm de largo.

CADENA NO INCLUIDA



BASE RELLENABLE DE AGUA O ARENA



ESLABÓN DE ENCAJE

53839 0,25€

0.00	10	2000	16000
Kg	Sub	ff	ff



CADENA DE PLÁSTICO

53809 8,00€

0.30	-	40	960
Kg	Sub	ff	ff

- Longitud: 5m
- Eslabón: 6mm
- Color: Rojo / Blanco

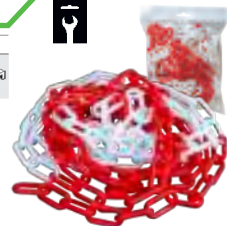

POSTE DE SEPARACIÓN CON CINTA RETRÁCTIL

53914 75,00€

8.50	-	5	90
Kg	Sub	ff	ff

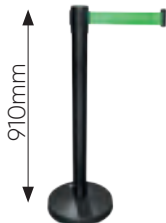

- Material: Acero
- Diámetro del tubo: 63mm
- Diámetro de la base: 320mm
- Altura: 910mm

- Salida de cinta en 4 direcciones
- Largo de la cinta: 3m
- Ancho de cinta: 48mm

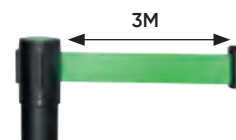

Salida de cinta en 4 direcciones

CINTA ADHESIVA DE SEÑALIZACIÓN DISTANCIA DE SEGURIDAD

53840ES 6,00€

0.05	10	360	-
Kg	Sub	ff	ff

1.000x1.000 mm

DISPONIBLE EN CUALQUIER IDIOMA

- Texto:
"¡POR FAVOR! MANTENGA LA DISTANCIA DE SEGURIDAD"



CABALLETE DE ADVERTENCIA DISTANCIA DE SEGURIDAD

53812 23,50€

0.30	-	-	240
Kg	Sub	ff	ff

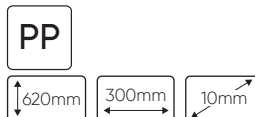

GENERADORES DE OZONO PORTÁTILES

Desinfección y limpieza de ambientes, eliminación de olores mediante ozono O3.



HIGIENIZA



ANTI BACTERIAS



PURIFICA

5.000mg/h

53786 98,00€

2,20 - 8 32
Kg SUB

158mm 172mm 187mm

67W 2 Amp 80 CFM

PLACA PARA REF. 53786
14775
30,50€

600mg/h

53796 76,00€

0,90 - 8 128
Kg SUB



80mm 130mm 180mm

15W Q 12V 220V 15m³/h

- LIGERO, RÁPIDO Y POTENTE
- BAJO NIVEL DE RUIDO
- TAMAÑO PORTÁTIL



IDEAL PARA VEHICULOS



Conexión a la red y conexión a toma de mechero.

Tiempo de operación recomendado según tamaño de la habitación:

50m³ 100m³ 150m³ 200m³ 300m³ 20min 40min 60min 80min 100min

10.000mg/h

53805 220,00€

2,80 - 4 40
Kg SUB

275mm 190mm 235mm



95W Q 1000mg/h 100 CFM 220V 240V 20x10 30000h

PLACA PARA REF. 53805

14802
44,00€

Volumen habitación	Tiempo de trabajo requerido
50m³	8 min
100m³	16 min
150m³	24 min
200m³	32 min
300m³	48 min

- Ligero, rápido y potente.
- Bajo nivel de ruido.
- 3 tipos de desinfección: ozono, ion, ozono + ion.
- Temporizador y modelo de retención.
- Tamaño portátil con asa.

10.000mg/h - 20.000mg/h

53806 250,00€

3,90 - 4 32
Kg SUB

242mm 233mm 300mm



UV

INCORPORA LUZ UV PARA ESTERILIZAR

PLACA PARA REF. 53806

14803
43,00€

190W Q 120 CFM 220V 240V 20000h 90 dB

2 MODOS DE TRABAJO

LOW 10.000mg/h		HIGH 20.000mg/h	
Volumen habitación	Tiempo de trabajo requerido	Volumen habitación	Tiempo de trabajo requerido
50m³	8 min	500m³	30 min
100m³	16 min	600m³	40 min
150m³	24 min	700m³	50 min
200m³	32 min	800m³	60 min
300m³	48 min	900m³	70 min
500m³	65 min	1.000m³	80 min

CAJA DE TRATAMIENTO DE OZONO

53838 38,00€

1,10 - 8 96
Kg SUB

3min

TIEMPO DE DESINFECCIÓN

50mm 300mm

220mm 280mm 280mm



BOLSILLO POSTERIOR



DESMTABLE

La caja se monta y desmonta fácilmente, facilitando así su transporte.



- Longitud de onda ultravioleta: 254nm
- Toma de potencia: Conector micro-USB



5V 2W Amp 0.38-0.42 UV 1550 15-20 12V

- HIGIENIZA
- POTENTE
- SEGURO Y EFICAZ

- ELIMINA MALOS OLORES
- RÁPIDO
- TRANSPORTABLE

MEDIDOR DE OZONO

53802 120,00€

0,65 - 20 240
Kg SUB



- Precisión: $\pm 5\%$ F.S.
- Rango de medida: 0-50ppm (0-98mg/m³)
- Alarma baja: 5ppm (9.8mg/m³)
- Alarma alta: 10ppm (19.6 mg/m³)
- Tiempo de respuesta: <30 segundos
- Temperatura de trabajo: -10°C - 55°C
- Protección IP65.



109x60x30mm

DOS NIVELES DE ALARMA CONFIGURABLES PARA DIFERENTES NIVELES DE CONCENTRACIÓN

TIEMPO DE TRABAJO: >8H

TIEMPO DE CARGA: 4H-6H

Cumple con: EN61326-1, EN61000-4-2, EN61000-4-3



- (ES) SURTIDO DE ENGRASADORES
- (EN) METRIC GREASE FITTING ASSORTMENT
- (FR) MALETTE DE GRAISSEURS
- (DE) SATZ VON SCHMIERBUCHSEN MIT METRISCHEM GEWINDE
- (IT) SET DI INGRASSATORI CON FILETTATURA METRICA
- (PT) SURTIDO DE LUBRIFICADORES
- (RO) ASORTIMENT DE NIPLURI DE GRESARE
- (NL) SET VAN SMEEDERS MET METRISCHE DRAAD
- (HU) ZSIRZÖKÉSZLET METRIKUS MENETTEL
- (RU) НАБОР МАСЛЕНОК С МЕТРИЧЕСКОЙ РЕЗЬБОЙ
- (PL) ZESTAW OLFIARZEK O GWINCIE METRYCZNEJ

CONSUMIBLES

- 324 PASACABLES / PASADORES
- 325 PASADORES / TORNILLOS Y TUERCAS
- 327 REMACHES
- 328 ARANDELAS
- 331 OBUSES
- 332 JUNTAS TÓRICAS / TUBOS TERMORETRÁCTLES
- 333 CONECTORES DE MANGUERA / ENGRASADORES
- 334 ABRAZADERAS / MUELLES / FUSIBLES
- 335 TERMINALES
- 336 CLIPS PLÁSTICOS

ESTUCHE DE CIRCLIPS TIPO "E"

53348 14,00€

0,30 6 24 672
Kg SUB ff



150 PCS



	M1.5	M3	M5	M6	M9	M12	M15	M19	M22
	15 PCS	15 PCS	20 PCS	25 PCS	25 PCS	20 PCS	10 PCS	10 PCS	10 PCS

ESTUCHE DE PASACABLES DE GOMA

53349 14,00€

0,25 6 24 672
Kg SUB ff



125 PCS



19,5x23 2 PCS	16x24 3 PCS	13x15 3 PCS	11,5x19 4 PCS	10x20 3 PCS	10x12 5 PCS	25 2 PCS	22 3 PCS	19 4 PCS	15 5 PCS
	9,8x11,5 6 PCS	8x14 3 PCS	7,5x13 7 PCS	6x7,5 10 PCS	3,5x6 15 PCS		12 10 PCS	9 20 PCS	7 20 PCS

ESTUCHE DE PASACABLES DE GOMA

53370 26,00€

0,30 6 12 -
Kg SUB ff

190 PCS



	M2	M3	M4	M5	M6	M8	M10
	25 PCS	25 PCS	30 PCS	30 PCS	30 PCS	20 PCS	20 PCS

ESTUCHE DE PASADORES ELÁSTICOS

53350 14,00€

0,40 6 24 -
Kg SUB ff

120 PCS



1/16x3/16 4u.	3/32x1-1/4 4u.	3/16x1 5u.	1/4x1-3/4 4u.
1/16x5/16 4u.	1/8x5/8 5u.	3/16x1-1/4 5u.	5/16x3/4 4u.
1/16x3/4 4u.	1/8x1 5u.	7/32x5/8 4u.	5/16x1-1/2 4u.
5/64x1/4 4u.	1/8x1-1/4 5u.	7/32x1-1/4 4u.	5/16x2 4u.
5/64x1/2 4u.	5/32x5/8 4u.	7/32x1-3/4 4u.	3/8x3/4 2u.
5/64x1 4u.	5/32x1 4u.	1/4x5/8 4u.	3/8x1-1/2 2u.
3/32x5/8 4u.	5/32x1-1/2 4u.	1/4x1-1/4 4u.	3/8x2 2u.
3/32x1 4u.	3/16x5/8 5u.		

ESTUCHE DE PASADORES DE ALETAS

52027 14,00€

0,90 6 12 432
Kg SUB ff

365 PCS



	1,2x25mm 50 PCS	1,6x32mm 50 PCS	2x40mm 50 PCS	2,5x40mm 50 PCS	3,2x40mm 50 PCS
	3,2x50mm 50 PCS	4x50mm 40 PCS	5x63mm 10 PCS	6,3x63mm 15 PCS	

ESTUCHE DE PASADORES DE ALETAS INOX

53372 26,00€

1,30 6 12 -
Kg SUB ff

144 PCS



	3x50mm 50 PCS	4x60mm 30 PCS	5x75mm 20 PCS	6x50mm 20 PCS	6x75mm 16 PCS	8x60mm 8 PCS
--	------------------	------------------	------------------	------------------	------------------	-----------------

ESTUCHE DE PASADORES CON ANILLA

53371 29,00€

1,45 6 12 288
Kg SUB

50
PCS



	5x36	6x45	8x45	11x45
	16 PCS	18 PCS	6 PCS	10 PCS

ESTUCHE DE PASADORES CLEVIS Y CLIPS EN "R"

53363 34,00€

1,15 6 24 -
Kg SUB

71
PCS



	8x50	9,5x50	11x63	12,5x50
	5 PCS	18 PCS	5 PCS	3 PCS

	3,5x44	2,5x42	2,5x58	2x3
	6 PCS	20 PCS	7 PCS	7 PCS

ESTUCHE DE CLIPS "R"

52044 19,00€

0,55 6 12 384
Kg SUB

150
PCS



ESTUCHE DE PASADORES

53364 16,00€

0,80 6 24 -
Kg SUB

60
PCS



	3x3x25	3x3x20	5x5x30	5x5x25	5x5x20	6x6x40	6x6x30
	4 PCS	4 PCS	5 PCS	5 PCS	5 PCS	5 PCS	5 PCS
	5 PCS	8x8x40	8x8x30	10x10x40	10x10x30	12x12x40	2 PCS

DESPIECE DISPONIBLE EN BOLSAS



REF.	MEDIDA	UDS.	€/u.
10882	2,00x32mm	42	0,25€
10883	1,60x36mm	30	0,25€
10884	1,60x42mm	25	0,25€
10793	2,30x43mm	25	0,25€
10794	3,20x52mm	20	0,40€
10795	3,80x75mm	8	0,60€

ESTUCHE DE TORNILLOS DE GANCHO

53352 12,00€

0,60 6 24 672
Kg SUB

151
PCS

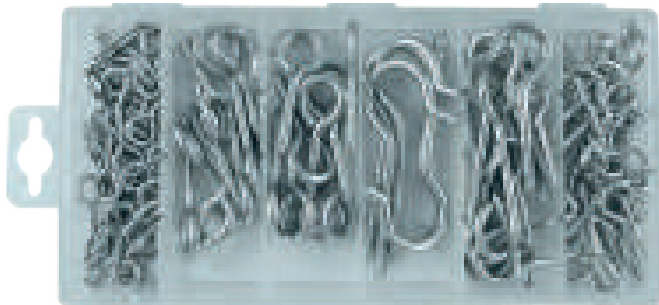

	2,4x25	4x45	4x50
	60 PCS	12 PCS	12 PCS

	2,4x41	4x64	4,2x85
	50 PCS	12 PCS	5 PCS

ESTUCHE DE TORNILLOS Y TUERCAS

53351 12,50€

0,90 6 12 -
Kg SUB

240
PCS



	4x12	4x20	5x16	5x25
	10 PCS	10 PCS	10 PCS	10 PCS
	10 PCS	6x30	8x25	8x40
	10 PCS	10 PCS	5 PCS	5 PCS
	5 PCS	10x40		
	5 PCS			

	4	5	6	8	10
	20 PCS	20 PCS	20 PCS	10 PCS	10 PCS

	4	5	6	8	10
	20 PCS	20 PCS	20 PCS	10 PCS	10 PCS

ESTUCHE DE TORNILLOS AUTOROSCANTES

53354 14,00€

0,55	6	24	-
Kg	Sub	ff	ff

200 PCS



#8x12.5	#8x16	#8x19	#8x25	#10x12.5	#10x16	#10x19	#10x25
30 PCS	30 PCS	30 PCS	30 PCS	20 PCS	20 PCS	20 PCS	20 PCS

ESTUCHE DE TORNILLOS ALLEN

53362 14,00€

0,65	6	24	672
Kg	Sub	ff	ff

106 PCS



4x12	5x12	5x25	10x40	6x25	8x40	10x25	6x12	8x25
25 PCS	25 PCS	20 PCS	3 PCS	10 PCS	5 PCS	3 PCS	10 PCS	5 PCS

ESTUCHE DE TORNILLOS Y TUERCAS TIPO U

53366 14,00€

0,30	6	24	672
Kg	Sub	ff	ff

170 PCS



M3 5X8	M4 2X16	M4.2	M3.5	M3.5
40 PCS	20 PCS	20 PCS	20 PCS	20 PCS
M6.35X19	M5X12	M5	M6.35	
15 PCS	10 PCS	15 PCS	10 PCS	

ESTUCHE DE TORNILLOS

53369 14,00€

0,65	6	24	672
Kg	Sub	ff	ff

550 PCS



2.8X13mm	3.5x13mm	3.5x19mm	4.2x16mm	4.2x31mm	4.8x25mm	2.8x16mm
65 PCS	65 PCS	45 PCS	40 PCS	20 PCS	20 PCS	55 PCS
3.5x10mm	3.5x16mm	4.2x13mm	4.2x25mm	4.8x19mm	4.8x32mm	
60 PCS	60 PCS	50 PCS	30 PCS	25 PCS	15 PCS	

ESTUCHE DE TUERCAS AUTOBLOCANTES

52029 14,00€

1,01	6	12	360
Kg	Sub	ff	ff

228 PCS



M3	M4	M5	M6	M8
50 PCS	50 PCS	40 PCS	30 PCS	20 PCS
M10	M12	M14	M16	
15 PCS	10 PCS	8 PCS	5 PCS	

ESTUCHE DE TUERCAS

52028 15,20€

1,05	6	12	360
Kg	Sub	ff	ff

243 PCS



DESPIECE DISPONIBLE EN BOLSAS

REF.	MEDIDA	UDS.	€/u.
10805	M3	50	0,10€
10779	M4	50	0,05€
10780	M5	50	0,05€
10781	M6	50	0,05€
10784	M8	50	0,05€
10785	M10	20	0,10€
10786	M12	40	0,15€

REF.	MEDIDA	UDS.	€/u.
10812	M14	8	0,30€
10813	M16	5	0,30€



ESTUCHE DE TUERCAS MARIPOSA

53365 14,00€

0,75	6	24	-
Kg	Sub	ff	



150 PCS



	M4	M5	M6	M8	M10
	40 PCS	40 PCS	25 PCS	25 PCS	20 PCS

ESTUCHE DE REMACHES TUERCA DE ALUMINIO

53361 24,00€

0,20	6	24	672
Kg	Sub	ff	



150 PCS

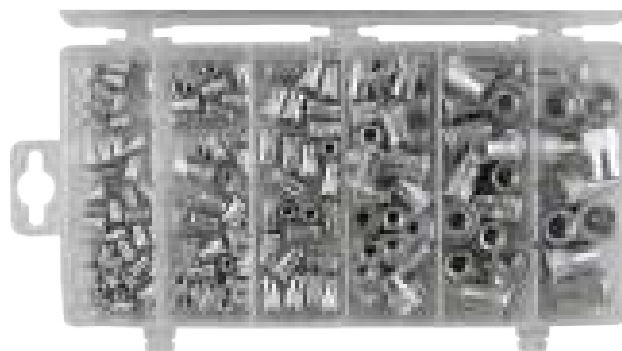

3x9	4x11	5x13	6x15	8x18	10x21
40 PCS	35 PCS	25 PCS	25 PCS	15 PCS	10 PCS

ESTUCHE DE REMACHES TUERCA

52703 22,00€

0,79	6	24	480
Kg	Sub	ff	

235 PCS



M3	M4	M5	M6	M8	M10	M12
50 PCS	50 PCS	50 PCS	40 PCS	20 PCS	15 PCS	10 PCS

DESPIECE DISPONIBLE EN BOLSAS

REF.	MEDIDA	UDS.	€/u.
13235	M3	200	0,15€
13236	M4	200	0,15€
13237	M5	200	0,15€
13238	M6	100	0,20€
13239	M8	50	0,20€
13240	M10	40	0,40€
13241	M12	20	0,55€



ESTUCHE DE REMACHES TUERCA

53360 18,00€

0,45	6	24	672
Kg	Sub	ff	



150 PCS



3x9	4x11	5x13	6x15	8x18	10x21
40 PCS	35 PCS	25 PCS	25 PCS	15 PCS	10 PCS

ESTUCHE DE REMACHES

52043 16,50€

0,80	6	12	384
Kg	Sub	ff	

300 PCS



4.8x16.9mm	4.8x24.8mm	
50 PCS	40 PCS	
3.2x9.7mm	4.8x12.7mm	4.8x20mm
90 PCS	70 PCS	50 PCS

ESTUCHE DE REMACHES PLÁSTICOS

52711 27,50€

0,44	6	24	384
Kg	Sub	ff	



150 PCS

REMACHADORA DISPONIBLE EN PAG. 48 Y 127 (REF. 52575)



DESPIECE DISPONIBLE EN BOLSAS



REF.	MEDIDA	UDS.	€/u.
13674	6x19,3mm	25	0,50€
13675	6x17,8mm	25	0,50€
13676	6x25,5mm	25	0,50€
13677	6x24,5mm	25	0,50€
13678	6x24mm	25	0,50€

6x19.3mm	6x17.9mm	6x25.5mm
25 PCS	25 PCS	25 PCS
6x24.5mm	6x24mm	6x24mm
25 PCS	25 PCS	25 PCS



DESPIECE DISPONIBLE EN BOLSAS

REF.	MEDIDA	Kg	Sub	ff	€ / u.	
10877	4,8x16,90mm	0,04	5	500	2.000	0,25€
10878	4,8x24,80mm	0,01	10	500	1.800	0,30€
10879	3,2x9,70mm	0,02	10	500	4.000	0,20€
10880	4,8x12,70mm	0,03	10	500	2.000	0,20€
10881	4,8x20,00mm	0,04	10	500	1.480	0,25€



ESTUCHE DE SURTIDO DE TORNILLOS, TUERCAS Y ARANDELAS

51804 58,00€

828
PCS

5,68	-	5	120
Kg	Sub	ff	

DESPIECE DISPONIBLE EN BOLSAS

REF.	MEDIDA	5 Kg	UDS.	€/u.
10772	Tornillo Zincado DIN 933 8.8 M4x25	0,01	25	0,05€
10773	Tornillo Zincado DIN 933 8.8 M5x25	0,01	25	0,10€
10774	Tornillo Zincado DIN 933 8.8 M6x25	0,01	25	0,10€
10775	Tornillo Zincado DIN 933 8.8 M7x50	0,01	15	0,15€
10776	Tornillo Zincado DIN 933 8.8 M8x50	0,01	15	0,20€
10777	Tornillo Zincado DIN 933 8.8 M10x50	0,04	12	0,20€
10778	Tornillo Zincado DIN 933 8.8 M12x60	0,05	20	0,35€
10779	Tuerca Zincada DIN 934 M4	0,02	50	0,05€
10780	Tuerca Zincada DIN 934 M5	0,01	50	0,05€
10781	Tuerca Zincada DIN 934 M6	0,01	50	0,05€
10782	Tuerca Zincada DIN 934 M7	0,01	50	0,05€
10784	Tuerca Zincada DIN 934 M8	0,01	50	0,05€
10785	Tuerca Zincada DIN 934 M10	0,01	50	0,10€
10786	Tuerca Zincada DIN 934 M12	0,01	40	0,15€
10787	Arandela Zincada DIN 125 M4	0,01	50	0,05€



REF.	MEDIDA	5 Kg	UDS.	€/u.
10788	Arandela Zincada DIN 125 M5	0,01	50	0,05€
10789	Arandela Zincada DIN 125 M6	0,01	50	0,05€
10790	Arandela Zincada DIN 125 M7	0,01	50	0,05€
10791	Arandela Zincada DIN 125 M8	0,01	50	0,05€
10792	Arandela Zincada DIN 125 M10	0,01	50	0,05€
10783	Arandela Zincada DIN 125 M12	0,01	50	0,05€
50959	Caja 19 compartimentos	0,7	1	12,00€

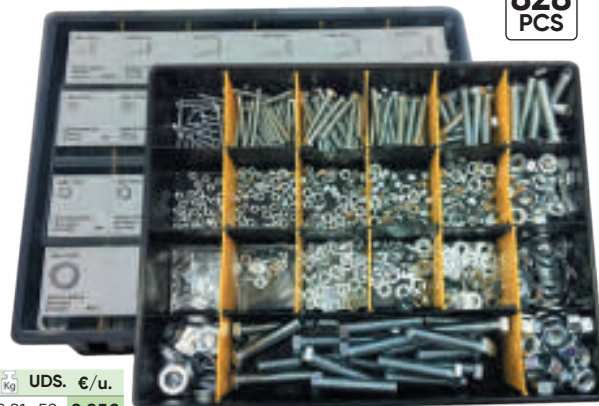

ESTUCHE DE ARANDELAS DE HIERRO GALVANIZADO

52158 38,50€

475
PCS

3,45	-	5	90
Kg	Sub	ff	

5x20x1,5mm 50 PCS	6x20x1,5mm 50 PCS	7x20x1,5mm 50 PCS
8x20x1,5mm 50 PCS	8x20x1,75mm 50 PCS	10x30x2,5mm 25 PCS
6x30x2mm 25 PCS	7x30x2mm 25 PCS	8x30x2mm 25 PCS
4x11x0,98mm 50 PCS	12x40x3mm 25 PCS	4x20x1,5mm 50 PCS



ESTUCHE DE ARANDELAS DE HIERRO SOBREMEDIDA

53377 20,00€

240
PCS

1,60	6	12	-
Kg	Sub	ff	

20x6x1.5 20 PCS	20x8x1.5 20 PCS	20x10x1.5 20 PCS	25x6x1.5 20 PCS
32x2x1.5 20 PCS	32x4x1.5 20 PCS	32x6x1.5 20 PCS	32x8x1.5 20 PCS
25x10x1.5 20 PCS	32x10x1.5 20 PCS	32x10x1.5 20 PCS	25x8x1.5 20 PCS

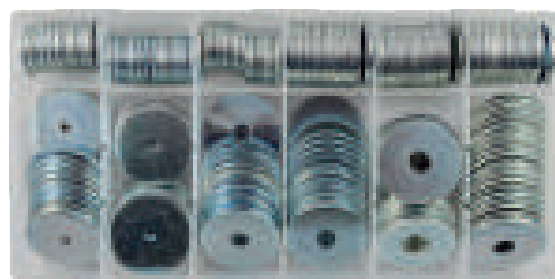

ESTUCHE DE ARANDELAS DE ALUMINIO

52031 44,00€

900
PCS

0,56	6	18	288
Kg	Sub	ff	

3x7x1,5mm 50 PCS	4x8x1,5mm 50 PCS	5x6x1,5mm 50 PCS	16x22x1,5mm 50 PCS	14x22x1,5mm 50 PCS	14x20x1,5mm 50 PCS
6x10x1,5mm 50 PCS	6x11x1,5mm 50 PCS	7x11x1,5mm 50 PCS	7x12x1,5mm 50 PCS	8x12x1,5mm 50 PCS	8x14x1,5mm 50 PCS
9x12x1,5mm 50 PCS	10x14x1,5mm 50 PCS	11x16x1,5mm 50 PCS	11x17x1,5mm 50 PCS	12x16x1,5mm 50 PCS	12x16x1,5mm 50 PCS



ESTUCHE DE ARANDELAS GROWER NEGRAS

52032 28,00€

1.735 PCS

1,68 - 5 870
Kg SUB 11 16

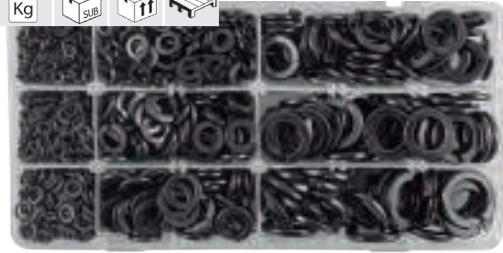

3mm 600 PCS	4mm 400 PCS	5mm 220 PCS	6mm 220 PCS	8mm 110 PCS
10mm 65 PCS	12mm 50 PCS	14mm 40 PCS	16mm 30 PCS	

ESTUCHE DE ARANDELAS DE COBRE PARA INYECTORES

53229 38,70€

150 PCS



0,40 5 20 720
Kg SUB 11 16



13.8x7.3x1.4mm 10 PCS	15.0x7.0x2.0mm 10 PCS	15.0x7.5x2.5mm 10 PCS	16.0x7.5x1.7mm 10 PCS	16.0x7.5x2.0mm 10 PCS	16.4x7.5x2.0mm 10 PCS
14.6x7.5x1.3mm 10 PCS	15.0x7.5x1.0mm 10 PCS	15.0x7.5x2.0mm 10 PCS	15.0x7.5x3.0mm 10 PCS	16.0x7.5x1.5mm 10 PCS	20.0x9.4x0.9mm 10 PCS
14.6x7.5x3.0mm 10 PCS	15.0x7.5x1.5mm 10 PCS	15.5x7.5x2.0mm 10 PCS			

53340 86,00€

375 PCS



0,90 - 10 1050
Kg SUB 11 16

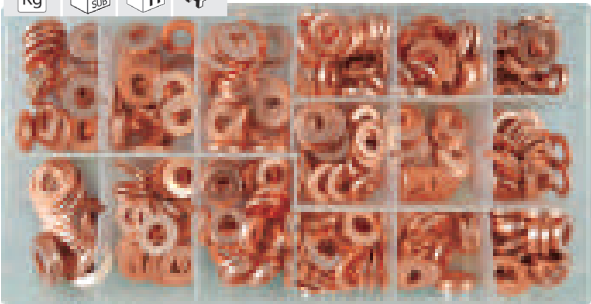

13.8x7.3x1.4mm 25 PCS	15.0x7.0x2.0mm 25 PCS	15.0x7.5x2.0mm 25 PCS	15.5x7.5x2.0mm 25 PCS	16.0x7.5x2.0mm 25 PCS
14.6x7.5x1.3mm 25 PCS	15.0x7.5x1.0mm 25 PCS	15.0x7.5x2.5mm 25 PCS	16.0x7.5x1.5mm 25 PCS	16.4x7.5x2.0mm 25 PCS
14.6x7.5x3.0mm 25 PCS	15.0x7.5x1.5mm 25 PCS	15.0x7.5x3.0mm 25 PCS	16.0x7.5x1.7mm 25 PCS	20.0x9.4x0.9mm 25 PCS

DESPIECE DISPONIBLE EN BOLSAS

13819 50 6,50€ 13.8 x 7.3 x 1.4 mm	13822 50 11,00€ 15.0 x 7.0 x 2.0 mm	13825 50 11,50€ 15.0 x 7.5 x 2.0 mm	13828 50 11,50€ 15.5 x 7.5 x 2.0 mm	13831 50 12,60€ 16.0 x 7.5 x 2.0 mm
13820 50 7,00€ 14.6 x 7.5 x 1.3 mm	13823 50 6,00€ 15.0 x 7.5 x 1.0 mm	13826 50 13,00€ 15.0 x 7.5 x 2.5 mm	13829 50 10,50€ 16.0 x 7.5 x 1.5 mm	13832 50 13,00€ 16.4 x 7.5 x 2.0 mm
13821 50 14,00€ 14.6 x 7.5 x 3.0 mm	13824 50 8,00€ 15.0 x 7.5 x 1.5 mm	13827 50 15,00€ 15.0 x 7.5 x 3.0 mm	13830 50 10,50€ 16.0 x 7.5 x 1.7 mm	13833 50 9,00€ 20.0 x 9.4 x 0.9 mm

ESTUCHE DE ARANDELAS DE COBRE

52030 98,00€

900 PCS

1,21 3 18 288
Kg SUB 11 16



DESPIECE DISPONIBLE

REF.	MEDIDA	Kg	€ / u.
10823	3x7x1,5mm	0,01 50	0,20€
10824	4x8x1,5mm	0,01 50	0,20€
10825	5x6x1,5mm	0,01 50	0,20€
10826	16x22x1,5mm	0,01 50	0,40€
10827	14x22x1,5mm	0,01 50	0,60€
10828	14x20x1,5mm	0,01 50	0,45€
10829	6x10x1,5mm	0,01 50	0,20€
10830	6x11x1,5mm	0,01 50	0,20€
10831	7x11x1,5mm	0,01 50	0,20€
10832	7x12x1,5mm	0,01 50	0,20€
10833	8x12x1,5mm	0,01 50	0,20€
10834	8x14x1,5mm	0,01 50	0,25€
10835	9x12x1,5mm	0,01 50	0,25€

REF.	MEDIDA	Kg	€ / u.
10836	10x14x1,5mm	0,01 50	0,30€
10837	11x16x1,5mm	0,01 50	0,30€
10838	11x17x1,5mm	0,01 50	0,30€
10839	12x16x1,5mm	0,01 50	0,40€
10840	12x18x1,5mm	0,01 50	0,35€

























ESTUCHE DE ARANDELAS DE COBRE PARA INYECTORES

53464 153,00€

1,85 - 5 90
Kg SUB

30 DESPIECE DISPONIBLE

- | | | |
|---|---|--|
|  UNIVERSAL
Ø15.0X8.0X1.5
13945 7,40€ |  MERCEDES
Ø15.0X7.0X1.5
13946 6,70€ |  RENAULT
Ø13.0X7.5X2.5
13947 5,85€ |
|  IVECO, FORD,
BMW, MAN
Ø15.0X7.5X1.5
13948 5,00€ |  UNIVERSAL
Ø15.0X7.5X2.0MM
13949 6,50€ |  UNIVERSAL
Ø15.45X8.0X2.0
13950 7,80€ |
|  MAZDA
Ø13.5X10X2.0
13951 5,15€ |  FORD
Ø15.5X7.5X2.5
13952 10,90€ |  LAND ROVER
Ø15.5X7.5X1.5
13953 8,00€ |
|  RENAULT
Ø15.0X7.5X3.0
13954 12,70€ |  DEUTZ
Ø13.0X7.0X1.5
13955 4,95€ |  FORD
Ø13.5X7.5X1.5
13956 4,30€ |
|  FIAT
Ø15.0X7.5X1.5
13957 9,70€ |  MAN ROVER
Ø15.5X7.5X1
13958 5,45€ |  MERCEDES
Ø16.5X7.5X2
13959 10,10€ |
|  KIA
Ø13.7X7.3X3
13960 9,65€ |  KIA
Ø13.7X7.3X2
13961 9,25€ |  ACERO
Ø10X6.0X1.0
13962 1,76€ |
|  LATÓN
Ø15.8X7.5X3.0
13963 12,40€ |  CONECTOR DE MANGUERA "T"
13964 15,00€ |  ALUMINIO
Ø8X5.8X1
13965 1,50€ |
|  CONECTOR DE MANGUERA "L"
13966 12,90€ |  RESORTES DE RETENCIÓN
13967 4,65€ | |



Ø15.0X8.0X1.5 30 PCS	Ø15.0X7.0X1.5 12 PCS	Ø13.0X7.5X2.5 30 PCS	Ø15.0X7.5X1.5 30 PCS	Ø15.45X8.0X2.0 30 PCS
Ø15.45X8.0X2.0 30 PCS	Ø13.5X10X2.0 12 PCS	Ø15.5X7.5X2.5 30 PCS	Ø15.5X7.5X1.5 12 PCS	Ø15.0X7.5X3.0 30 PCS
Ø13.0X7.0X1.5 12 PCS	Ø13.5X7.5X1.5 30 PCS	Ø15.0X7.5X1.5 12 PCS	Ø15.5X7.5X1 12 PCS	Ø16.5X7.5X2 30 PCS
Ø13.7X7.3X3 12 PCS	Ø13.7X7.3X2 12 PCS	Ø10X6.0X1.0 50 PCS	Ø15.8X7.5X3.0 30 PCS	Ø8X5.8X1 30 PCS
"T" 20 PCS	"L" 30 PCS	resortes de retención 25 PCS		



ARANDELAS DE TAPÓN DE CÁRTER

- | | | |
|---|---|---|
|  Ø 10MM / 0,02KG
52719 0,19€
0,04 100 5000 150000
Kg SUB |  GOMA (Ford)
Ø 13MM / 0,01KG
51554 0,28€
0,01 100 5000 180000
Kg SUB |  Ø 16MM / 0,01KG
51799 0,20€
0,01 50 2500 120000
Kg SUB |
|  Ø 12MM / 0,03KG
51843 0,19€
0,01 100 5000 200000
Kg SUB |  Ø 14MM / 0,01KG
51546 0,19€
0,01 100 5000 150000
Kg SUB | |

ESTUCHE DE ARANDELAS DE COBRE PARA TAPÓN DE CÁRTER

52163 95,00€

0,65 - 6 18 288
Kg SUB



Ø10MM 100 PCS	Ø12MM 100 PCS	Ø14MM 100 PCS
Ø16MM 100 PCS	Ø18MM 100 PCS	Ø20MM 25 PCS



COMPRIMIBLE

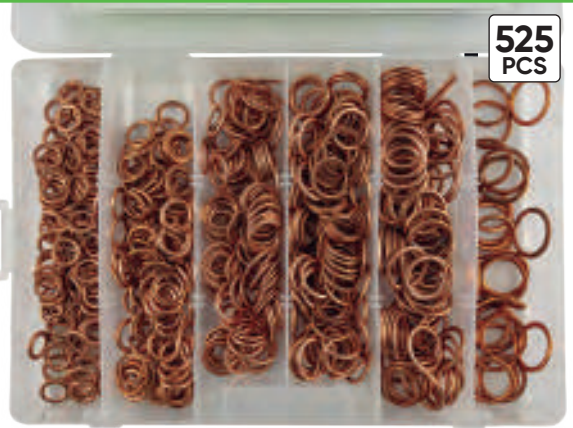

ESTUCHE DE ARANDELAS DE COBRE

53353 18,00€

0,20 6 24 720
Kg SUB ITT



110 PCS

	M6	M8	M10	M12	M14	M16
	30 PCS	25 PCS	20 PCS	15 PCS	10 PCS	10 PCS

ESTUCHE DE ARANDELAS DENTADAS INTERIOR

53373 14,50€

0,25 6 24 672
Kg SUB ITT



260 PCS

	M3x10	M4x12	M5x14	M6x14	M8x18	M10x20	M12x25
	30 PCS	30 PCS	40 PCS	50 PCS	50 PCS	40 PCS	20 PCS

ESTUCHE DE ARANDELAS SEGER EXTERIORES

53383 11,50€

0,20 6 24 672
Kg SUB ITT



300 PCS

	M4	M6	M8	M10	M12
	50 PCS	40 PCS	45 PCS	30 PCS	30 PCS
	M14	M16	M18	M20	M22
	25 PCS	25 PCS	25 PCS	15 PCS	15 PCS

ESTUCHE DE ARANDELAS SEGER INTERIORES

53382 11,00€

0,15 6 24 672
Kg SUB ITT



300 PCS

	M4	M6	M8	M10	M12
	50 PCS	40 PCS	45 PCS	30 PCS	30 PCS
	M14	M16	M18	M20	M22
	25 PCS	25 PCS	25 PCS	15 PCS	15 PCS

SURTIDO DE ARANDELAS DE FIBRA

53381 14,50€

0,19 6 12 384
Kg SUB ITT



600 PCS

	10x5.5x1	16x10x1	19x12x1	22x16x1	22.5x14x1	32x22x1
	160 PCS	80 PCS	40 PCS	30 PCS	20 PCS	20 PCS
	12x6.5x1	16x8x1	20x12.5x1	27x20x1	25.4x17.5x1	32x24x1
	100 PCS	60 PCS	40 PCS	20 PCS	15 PCS	15 PCS

ESTUCHE DE OBUSES PARA AIRE ACONDICIONADO

53599 30,30€

0,16 10 100 -
Kg SUB ITT

5mm L: 19mm	6mm L: 19mm	7mm L: 20mm
5mm L: 19mm	6mm L: 22mm	8mm L: 22mm
5mm L: 19mm	6mm L: 26.5mm	9mm L: 22mm



134 PCS

DESPIECE DISPONIBLE

REF.	MEDIDA	Kg	u.	€/u.
14594	5x19mm R12 (verde)	0,01	10	2,00€
14595	5x19mm	0,01	10	1,50€
14596	5x19mm R12	0,01	10	2,00€
14597	6x19mm	0,01	10	7,60€
14598	6x26mm	0,01	10	17,80€
14599	7x20mm R134A	0,01	10	4,50€
14600	6x22mm	0,01	10	9,50€
14601	8x22mm	0,01	10	11,00€
14602	9x22mm	0,01	10	11,00€



ESTUCHE DE JUNTAS TÓRICAS

MÉTRICAS - 386 UNIDADES

		006	007	008	009	010	011
TAPA DEL ESTUCHE	Posición del estuche	006	007	008	009	010	011
	Ancho de goma (mm)	2	2	2	2	2	2
	Ø Interior (mm)	3	4	5	6	7	8
	Cantidad	16	16	16	16	16	16
TAPA DEL ESTUCHE	Posición del estuche	113	112	111	110	012	
	Ancho de goma (mm)	2.5	2.5	2.5	2.5	2	
	Ø interior (mm)	14	12	11	10	10	
	Cantidad	13	13	13	13	17	
TAPA DEL ESTUCHE	Posición del estuche	114	115	116	210		
	Ancho de goma (mm)	2.5	2.5	2.5	3		
	Ø interior (mm)	16	17	19	19		
	Cantidad	13	13	13	10		
BASE DEL ESTUCHE	Posición del estuche	222	325	326	327		
	Ancho de goma (mm)	3	4	4	4		
	Ø Interior (mm)	38	38	41	44		
	Cantidad	12	10	9	9		
BASE DEL ESTUCHE	Posición del estuche	221	220	219	218	217	
	Ancho de goma (mm)	3	3	3	3	3	
	Ø interior (mm)	36	35	33	32	30	
	Cantidad	12	12	12	12	12	
BASE DEL ESTUCHE	Posición del estuche	211	212	213	214	215	216
	Ancho de goma (mm)	3	3	3	3	3	3
	Ø interior (mm)	20	22	24	25	27	28
	Cantidad	12	12	12	12	12	12

50651 16,50€

0,55 5 20 360
Kg SUB



386
PCS

PULGADAS - 386 UNIDADES

		006	007	008	009	010	011
TAPA DEL ESTUCHE	Posición del estuche	006	007	008	009	010	011
	Ancho de goma	1/16	1/16	1/16	1/16	1/16	1/16
	Ø interior	1/8	5/32	3/16	7/32	1/4	5/16
	Cantidad	20	20	20	20	20	20
TAPA DEL ESTUCHE	Posición del estuche	113	112	111	110	012	
	Ancho de goma	3/32	3/32	3/32	3/32	1/16	
	Ø interior	9/16	1/2	7/16	3/8	3/8	
	Cantidad	13	13	13	13	13	
TAPA DEL ESTUCHE	Posición del estuche	114	115	116	210		
	Ancho de goma	3/32	3/32	3/32	1/8		
	Ø interior	5/8	11/16	3/4	3/4		
	Cantidad	13	13	13	10		
BASE DEL ESTUCHE	Posición del estuche	222	325	326	327		
	Ancho de goma	1/8	3/16	3/16	3/16		
	Ø interior	11/2	11/2	15/8	13/4		
	Cantidad	10	7	7	7		
BASE DEL ESTUCHE	Posición del estuche	221	220	219	218	217	
	Ancho de goma	1/8	1/8	1/8	1/8	1/8	
	Ø interior	17/16	13/8	15/16	11/4	13/16	
	Cantidad	10	10	10	10	10	
BASE DEL ESTUCHE	Posición del estuche	211	212	213	214	215	216
	Ancho de goma	1/8	1/8	1/8	1/8	1/8	1/8
	Ø interior	13/16	7/8	15/16	1	11/16	11/8
	Cantidad	10	10	10	10	10	10

50652 16,50€

0,66 5 20 360
Kg SUB



ESTUCHE DE JUNTAS TÓRICAS PARA AACC

50807 38,00€

0,16 6 24 672
Kg SUB



5.29X1.78MM 20 PCS	6.07x1.78mm 20 PCS	6.8x1.9mm 20 PCS			
7.65x1.78mm 20 PCS	7.80x1.90mm 20 PCS	8.0X2.0MM 20 PCS	8.80X1.90MM 20 PCS	10.82X1.78MM 15 PCS	
10.77X2.62MM 15 PCS	11.0X2.0MM 15 PCS	12.0X2.0MM 15 PCS	13.9x1.80mm 10 PCS	13.95x2.62mm 10 PCS	
14.0X2.0MM 10 PCS	15.0X2.0MM 10 PCS	17.0X2.00MM 10 PCS	17.17x1.78mm 10 PCS	17.04x3.53mm 10 PCS	



270
PCS

ESTUCHE DE TUBOS TERMORETRÁCTILES

53374 10,00€

0,15 6 24 672
Kg SUB



53376 10,50€

0,15 6 24 672
Kg SUB



53376



127
PCS

SOPLETE DE GAS

51920 18,00€

0,14 10 100 400
Kg SUB

M2x40 30 PCS	M2.5x40 25 PCS	M3.5x40 20 PCS	M5x40 20 PCS	M7x80 16 PCS	M10x80 8 PCS	M13x85 8 PCS
-----------------	-------------------	-------------------	-----------------	-----------------	-----------------	-----------------

VER PÁG. 215

332

SET DE MANGUITOS DE SOLDADURA TERMORETRACTILES

53992 18,00€

0.10 6 84 1512
Kg SUB

- Permite una conexión fácil y rápida de cables, soldado y sellado al mismo tiempo.
- Material anillo de soldado: estaño
- Material: PE

100
PCS



 Ø1.7mm 0.25-0.34mm ² 26-24 AWG 25 PCS	 Ø2.7mm 0.5-1.0mm ² 22-18 AWG 35 PCS	 Ø4.7mm 1.5-2.5mm ² 16-14 AWG 30 PCS	 Ø6.0mm 4.0-6.0mm ² 12-10 AWG 10 PCS
---	---	---	---

ESTUCHE DE CONECTORES DE MANGUERA

53910 19,00€

0.25 6 24 480
Kg SUB



RECTO		REDUCTOR	
 4.8x4.8 10 PCS	 6.3x6.3 8 PCS	 3.17x3.17 30 PCS	 9.5x6.3 6 PCS
 7.9x7.9 6 PCS	 9.5x9.5 6 PCS		 6.3x4.8 10 PCS
en T			
 3.9x3.9x3.9 8 PCS	 4.8x4.8x4.8 8 PCS	 3.17x3.17x3.17 12 PCS	
 6.3x6.3x6.3 6 PCS	 9.5x9.5x9.5 3 PCS		

113
PCS

53434 18,00€

0.15 6 24 672
Kg SUB



 4x28.7 10 PCS	 3.9x30.8 5 PCS	 10.4x44.4 10 PCS	 5.6x47.1 5 PCS
 7.9x38 10 PCS	 4.7x38.9 5 PCS	 5.2x33.9 10 PCS	 7x30 10 PCS

65
PCS

ESTUCHE DE ENGRASADOR

52033 43,00€

0.89 6 24 576
Kg SUB

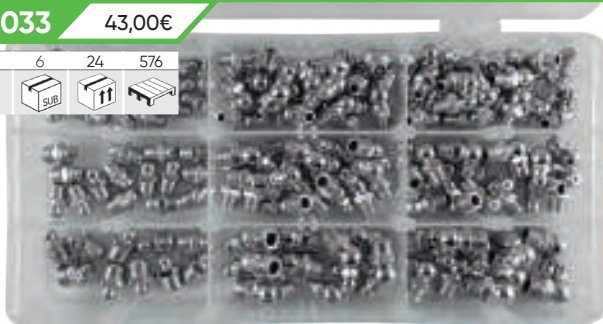

DESPIECE DISPONIBLE

135
PCS

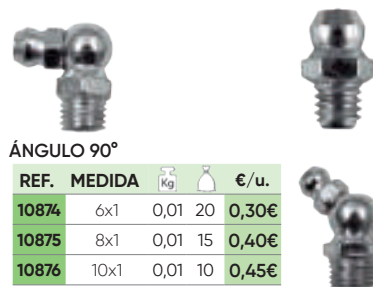

ÁNGULO 90°

REF.	MEDIDA	Kg	€/u.
10874	6x1	0,01 20	0,30€
10875	8x1	0,01 15	0,40€
10876	10x1	0,01 10	0,45€

ÁNGULO RECTO

REF.	MEDIDA	Kg	€/u.
10868	6x1	0,01 20	0,30€
10869	8x1	0,01 20	0,30€
10870	10x1	0,01 10	0,45€

ÁNGULO 45°

REF.	MEDIDA	Kg	€/u.
10871	6x1	0,01 20	0,30€
10872	8x1	0,01 15	0,40€
10873	10x1	0,01 10	0,45€

SURTIDO DE ENGRASADORES

53359 16,00€

0.49 6 24 672
Kg SUB



 6x1 5 PCS	 8x1.25 5 PCS	 10x1.5 5 PCS
 6x1 60 PCS	 8x1.25 10 PCS	 10x1.5 10 PCS
 6x1 5 PCS	 8x1.25 5 PCS	 10x1.5 5 PCS

110
PCS

SURTIDO DE ABRAZADERAS DE TUBO

53378 13,00€

0,45 6 24 672
Kg SUB ff

	1" 4 PCS	1-1/4" 2 PCS	1-3/4" 2 PCS	2" 4 PCS
	2-1/2" 2 PCS	3" 2 PCS	3-1/2" 2 PCS	4" 2 PCS



20 PCS



ESTUCHE DE MUELLES

53358 11,50€

0,35 6 24 672
Kg SUB ff

	9/32x1/2 10 PCS	1/4x13/32 10 PCS	7/32x11/16 10 PCS	7/32x1-1/2 10 PCS
	5/16x1-3/4 12 PCS	3/8x5/8 8 PCS	3/8x3/4 12 PCS	23/64x1-3/8 8 PCS
	13/64x13/16 10 PCS	7/32x1 10 PCS	1/4x7/8 10 PCS	5/16x1-1/8 8 PCS
	3/16x1-3/4 8 PCS	9/32x1-1/2 10 PCS	11/32x1-7/16 10 PCS	11/32x1-27/32 12 PCS
				9/32x2 12 PCS
				5/32x3-1/8 12 PCS



200 PCS



SET DE 2 PINZAS DE COCODRILO

53357 7,00€

0,01 6 24 1080
Kg SUB ff



2 PCS
30 AMP



ESTUCHE DE MINI FUSIBLES

53355 11,50€

0,15 6 24 672
Kg SUB ff



120 PCS



	5A 20 PCS	10A 20 PCS	15A 20 PCS	20A 20 PCS	25A 20 PCS	30A 20 PCS
--	-----------	------------	------------	------------	------------	------------

ESTUCHE DE FUSIBLES

53356 11,50€

0,25 6 24 672
Kg SUB ff

	15A 20 PCS
--	------------

	5A 20 PCS	10A 20 PCS
--	-----------	------------

	20A 20 PCS	25A 20 PCS	30A 20 PCS
--	------------	------------	------------



120 PCS



DESPIECE DISPONIBLE

REF.	MEDIDA	Kg	u.	€/u.
10915	5A	0,01	20	0,25€
10917	10A	0,01	20	0,30€
10918	15A	0,01	20	0,30€
10919	20A	0,01	20	0,30€
10920	25A	0,01	20	0,25€
10921	30A	0,01	20	0,30€

ESTUCHE DE FUSIBLES

53367 9,50€

0,10 6 24 1560
Kg SUB ff



48 PCS

	5A 8 PCS	10A 8 PCS	15A 8 PCS		20A 8 PCS	25A 8 PCS	30A 8 PCS
--	----------	-----------	-----------	--	-----------	-----------	-----------

ESTUCHE DE MINI FUSIBLES

53368 9,00€

0,10 6 24 1368
Kg SUB ff

Mini fusibles



50 PCS

	5A 8 PCS	10A 8 PCS	15A 8 PCS	20A 8 PCS	25A 8 PCS	30A 10 PCS
--	----------	-----------	-----------	-----------	-----------	------------

ESTUCHE DE MINI FUSIBLES

53380 11,50€

0,15 6 24 672
Kg SUB 11



	5A 20 PCS	10A 20 PCS	15A 20 PCS
	20A 20 PCS	25A 20 PCS	30A 20 PCS



ESTUCHE DE FUSIBLES

52054 17,00€

0,30 6 24 672
Kg SUB 11



DESPIECE DISPONIBLE



MINI XXA

REF.	COLOR	POTENCIA	Kg	Sub	11	€/u.
10905	Blue	3A	0,01	20	-	0,25€
10906	Red	4A	0,01	20	-	0,25€
10907	Brown	5A	0,01	20	-	0,25€



STANDARD XXA

REF.	COLOR	POTENCIA	Kg	Sub	11	€/u.
10914	Pink	4A	0,01	20	-	0,25€
10915	Yellow	5A	0,01	20	-	0,25€
12954	Purple	3A	0,01	20	-	0,25€

	3A	4A	5A	7,5A	10A	15A	20A	25A	30A
20 PCS	20 PCS	20 PCS	20 PCS	20 PCS	20 PCS	20 PCS	20 PCS	20 PCS	20 PCS
	3A	4A	5A	7,5A	10A	15A	20A	25A	30A
8 PCS	8 PCS	8 PCS	8 PCS	8 PCS	8 PCS	8 PCS	8 PCS	8 PCS	8 PCS



MINI XXA

REF.	COLOR	POTENCIA	Kg	Sub	11	€/u.
10908	Yellow	7,5A	0,01	20	-	0,30€
10909	Pink	10A	0,01	20	1000	0,30€
10910	Blue	15A	0,01	20	-	0,30€



STANDARD XXA

REF.	COLOR	POTENCIA	Kg	Sub	11	€/u.
10916	Brown	7,5A	0,01	20	-	0,30€
10917	Red	10A	0,01	20	4000	0,30€
10918	Blue	15A	0,01	20	3500	0,30€



MINI XXA

REF.	COLOR	POTENCIA	Kg	Sub	11	€/u.
10911	Yellow	20A	0,01	20	1000	0,30€
10912	Grey	25A	0,01	20	-	0,25€
10913	Green	30A	0,01	20	-	0,30€



STANDARD XXA

REF.	COLOR	POTENCIA	Kg	Sub	11	€/u.
10919	Yellow	20A	0,01	20	2000	0,30€
10920	Grey	25A	0,01	20	2000	0,25€
10921	Green	30A	0,01	20	2000	0,30€

ESTUCHE DE TERMINALES

52053 45,00€

0,55 6 24 576
Kg SUB 11



	RV1.25-4S	RV2-4S	RV2-6S	RV5.5-6S	RV5.5-5S	BV5.5
50 PCS	50 PCS	30 PCS	20 PCS	20 PCS	15 PCS	
	BV2	BV1.25	RV2-5S	SV1-4S	SV2-4S	FDD1.25-250
25 PCS	30 PCS	40 PCS	50 PCS	40 PCS	45 PCS	
	MDD1.25-250	FDD2-250	MDD2-250	FDD5.5-250	MDD5.5-250	FDFN1.25-250
50 PCS	40 PCS	50 PCS	25 PCS	30 PCS	25 PCS	

DESPIECE DISPONIBLE



635 PCS



REF.	COLOR	POTENCIA	Kg	Sub	11	€/u.
10885	Red	RV1.25-4S	0,01	20	-	0,20€
10886	Blue	RV2-4S	0,01	20	-	0,20€
10887	Yellow	RV2-6S	0,01	20	-	0,25€
10888	Green	RV5.5-6S	0,01	20	-	0,30€
10889	Orange	RV5.5-5S	0,01	20	-	0,30€
10893	Blue	RV2-5S	0,01	20	-	0,25€



REF.	COLOR	POTENCIA	Kg	Sub	11	€/u.
10894	Red	SV1-4S	0,01	20	-	0,20€
10895	Blue	SV2-4S	0,01	20	-	0,20€



REF.	COLOR	POTENCIA	Kg	Sub	11	€/u.
10890	Yellow	BV5.5	0,01	20	-	0,35€
10891	Blue	BV2	0,01	20	-	0,25€
10892	Red	BV1.25	0,01	20	-	0,30€



REF.	COLOR	POTENCIA	Kg	Sub	11	€/u.
10896	Red	FDD1.25-250	0,01	20	2000	0,30€
10898	Blue	FDD2-250	0,01	20	1500	0,30€
10900	Yellow	FDD5.5-250	0,01	20	2000	0,30€



REF.	COLOR	POTENCIA	Kg	Sub	11	€/u.
10902	Purple	FDFN 1.25-250	0,01	20	2000	0,30€



REF.	COLOR	POTENCIA	Kg	Sub	11	€/u.
10897	Red	MDD1.25-250	0,01	20	-	0,30€
10899	Blue	MDD2-250	0,01	20	3000	0,30€
10901	Yellow	MDD5.5-250	0,01	20	-	0,25€

ALICATES PARA TERMINALES

VER PÁG. 57



ESTUCHES DE CLIPS PLÁSTICOS

UNIDADES EN EL ESTUCHE

UNIDADES POR BOLSA RECAMBIO

BOLSAS POR SUBCAJA/CAJA

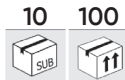

DESPIECE DISPONIBLE

PARA MAZDA

52896 26,00€



190 PCS

 13110 15 15 1,85€ OE 6508197AA	 13111 10 10 1,20€ OE B1016825200	 13112 6 6 1,65€ OE B09251833	 13113 20 20 2,20€ OE 992640543A	 13114 20 20 2,20€ OE B45556741	 13115 30 30 2,50€ OE G03158762
 13104 8 8 1,90€ OE 2042301	 13105 15 15 2,50€ OE 999100402	 13106 8 8 2,00€ OE B0016830200	 13107 8 8 2,15€ OE N30413356A	 13108 20 20 1,90€ OE 992640543A	 13109 30 30 2,90€ OE 99249051B



PARA TOYOTA / LEXUS

52886 18,00€



89 PCS

 13002 8 8 1,45€ OE 9018906001	 13003 5 4 1,70€ OE 9046707138	 13004 10 10 1,85€ OE 9046707117	 13005 10 10 1,25€ OE 9046709138	 13006 5 5 1,40€ OE 9046709101	 13007 10 10 1,30€ OE 75521611000
 13008 8 8 2,25€ OE 7503933060	 13009 4 4 1,65€ OE 9017905060	 13010 8 8 1,75€ OE 677711250	 13011 5 5 1,15€ OE 9046708124	 13012 8 8 1,80€ OE 7539533030	 13013 8 8 1,75€ OE 9046711063



PARA HONDA

52887 22,00€



150 PCS

 13014 12 12 1,45€ OE 75103SJ4003	 13015 5 5 1,20€ OE 90675SB003	 13016 6 6 1,15€ OE 91566SP0003	 13017 25 25 2,60€ OE 91513SE003	 13018 25 25 1,45€ OE 91530ST5003	 13019 15 15 1,75€ OE 90687SA50030
 13020 8 8 1,70€ OE 91620SR2003	 13021 8 8 1,30€ OE 38529689A6300	 13022 10 10 2,10€ OE 90683SA5003	 13023 10 10 1,50€ OE 90672671003	 13024 18 18 2,45€ OE 91534SE0000	 13025 8 8 1,50€ OE 34355SD2003



PARA PEUGEOT / CITROËN

52899 34,00€

0,50	6	24	336
Kg	Sub	Box	Tray

345
PCS



 13128 50 50 1,85€ OE 947098	 13129 20 20 2,00€ OE 856535	 13130 20 20 3,75€ OE 6991W4	 13131 20 20 3,45€ OE 6991W4	 13132 25 25 2,65€ OE 694143	 13133 35 35 3,45€ OE 743707
 13134 30 30 3,95€ OE 7703074022	 13135 35 35 3,45€ OE 7703077059	 13136 15 15 2,60€ OE 698317	 13137 25 25 2,25€ OE 699502	 13138 30 30 2,85€ OE 6995X3	 13139 40 40 3,85€ OE 69945

PARA FIAT

52900 34,00€

0,50	6	24	336
Kg	Sub	Box	Tray

308
PCS



 13140 30 30 2,65€ OE 14591784	 13141 20 10 1,80€ OE 1459487	 13142 25 25 3,10€ OE 1300433650	 13143 8 8 1,95€ OE 71717421	 13144 25 25 2,20€ OE 82456515	 13145 25 25 3,85€ OE 5751139
 13146 20 8 4,50€ OE 46306526	 13147 25 25 3,10€ OE 14591687	 13148 25 25 3,30€ OE 14592387	 13149 25 25 3,10€ OE 83468473	 13150 30 30 2,25€ OE 83468473	 13151 50 50 5,35€ OE 7677865

PARA VOLVO

52901 34,00€

0,48	6	24	216
Kg	Sub	Box	Tray

350
PCS



 13152 25 25 3,05€ OE 8099905N07	 13153 30 30 3,10€ OE 4292906	 13154 20 20 3,20€ OE 12681763	 13155 40 40 5,60€ OE 51131804205	 13156 40 40 3,30€ OE 947098	 13157 40 40 3,85€ OE 591740
 13158 25 25 3,75€ OE 6384801G00	 13159 20 20 3,20€ OE 9133417	 13160 40 40 5,00€ OE 9133073	 13161 30 30 3,55€ OE 3272075327462B	 13162 20 20 2,60€ OE 327462A	 13163 20 20 2,80€ OE 3923712

ESTUCHES DE CLIPS PLÁSTICOS

PARA VOLSKWAGEN

52889 19,00€

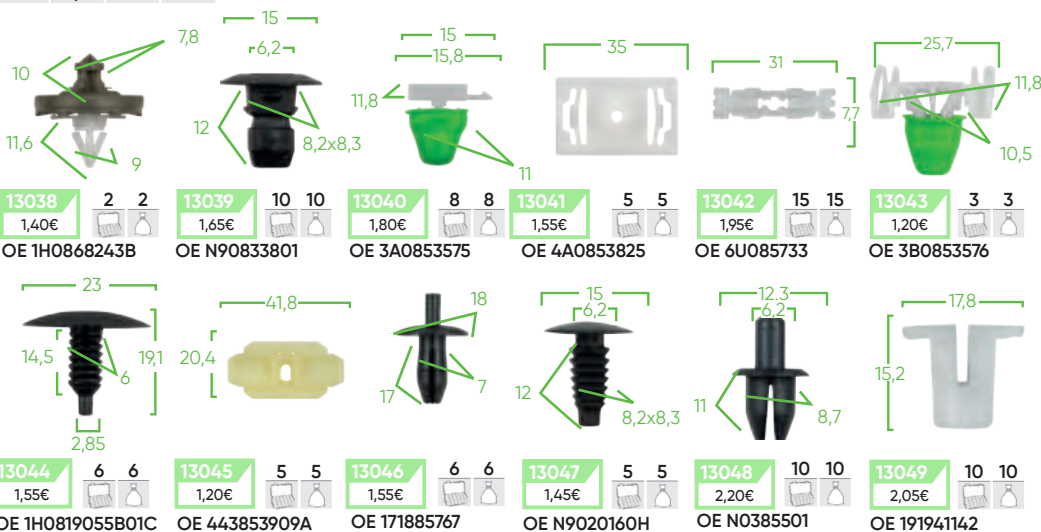

85 PCS



PARA BMW

52892 22,00€

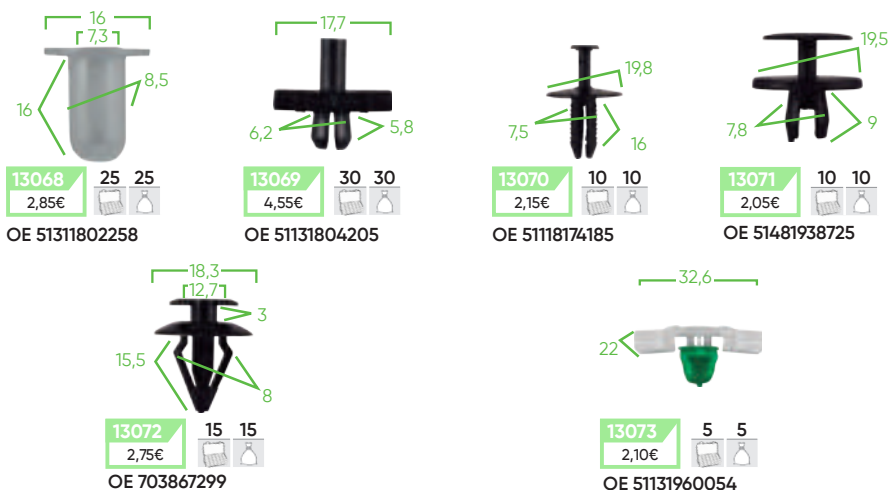
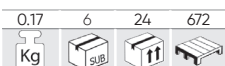

95 PCS



PARA NISSAN

52894 22,00€

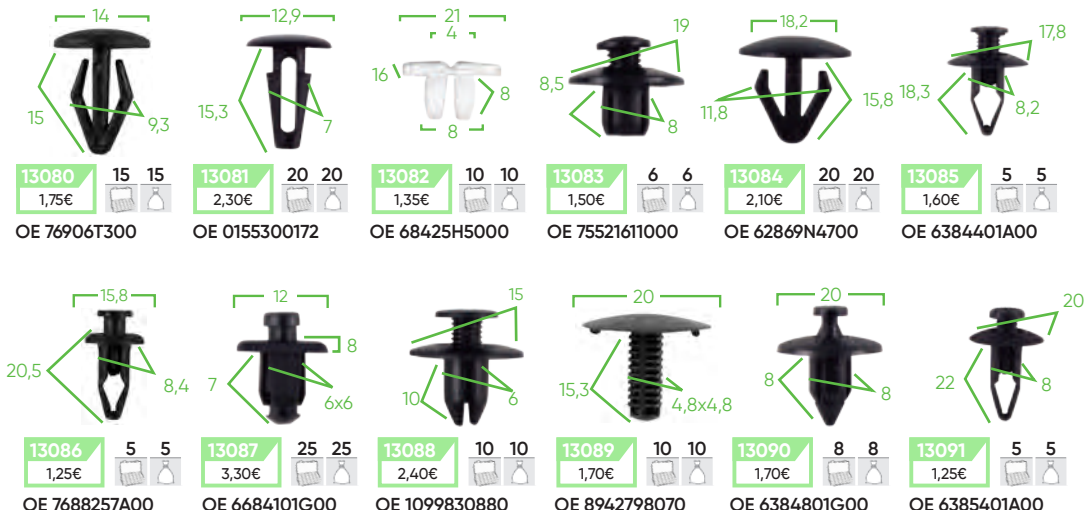

139 PCS



ESTUCHES DE CLIPS PLÁSTICOS

UNIDADES EN EL ESTUCHE



UNIDADES POR BOLSA RECAMBIO



BOLSAS POR SUBCAJA/CAJA

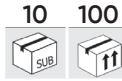

DESPIECE DISPONIBLE

PARA AUDI

52890 22,00€

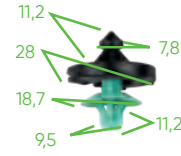
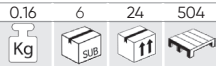

13052 3 3
1,25€
OE 1H0868243B

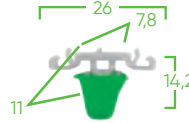

13054 5 5
2,35€

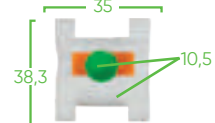

13055 3 3
3,00€
OE 3A0853575

31 PCS

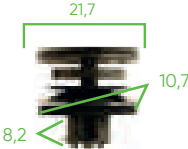

13050 5 5
1,55€
OE 3B0868243



13051 5 5
1,50€
OE 1H0867199A

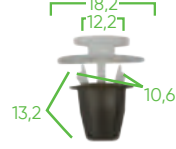

13053 10 10
2,80€
OE 357853575

PARA FORD

52891 28,00€

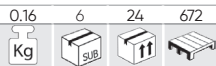

13056 8 8
1,55€
OE 388577S

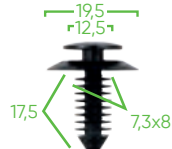

13057 5 5
1,50€
OE N801925S



13058 20 20
2,20€
OE N806289S

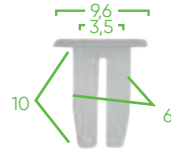

13059 20 20
2,35€
OE N379830S

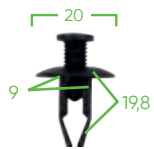

13060 5 5
1,60€
OE 1007932



13061 20 20
2,65€
OE 16500308

169 PCS

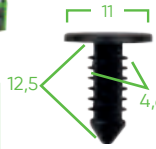

13062 20 20
2,35€
OE N803170S

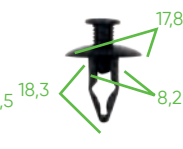

13063 6 6
1,15€
OE W706713S300

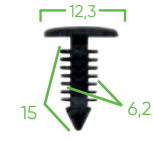

13064 20 20
2,60€
OE N388246S

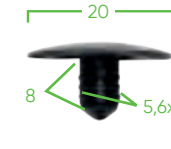

13065 15 15
2,00€
OE F22Z16774A

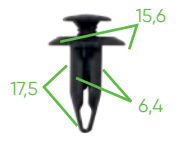

13066 5 5
2,25€
OE 1673046

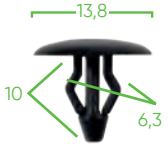

13067 25 25
2,55€
OE FICZ16674A

PARA MERCEDES BENZ

52893 26,00€

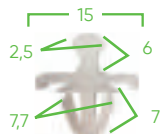
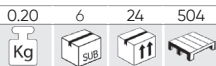

13074 30 30
4,65€
OE A0019884481



13075 20 20
5,35€
OE A0019882981



13076 15 15
3,90€
OE A1249900492



13077 4 4
2,55€
OE A0019888081

95 PCS

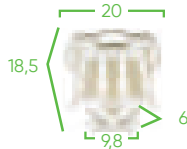

13078 6 6
2,55€
OE A1249880492

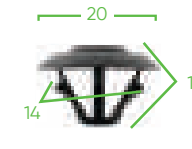

13079 20 20
3,35€
OE A0019880325

ESTUCHES DE CLIPS PLÁSTICOS

PARA RENAULT

52897 38,00€

0,43	6	24	336
Kg	Sub	11	



13116 5,45€ 50 50

OE 7703077421



13117 3,65€ 50 50

OE 7703074022



13118 15,90€ 60 60

OE 7703081184

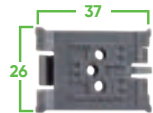

13119 5,60€ 15 15



13120 5,50€ 60 60

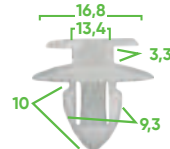

13121 8,75€ 65 65

OE 7703077059

300 PCS



PARA MITSUBISHI

52895 22,00€

0,19	6	24	1500
Kg	Sub	11	

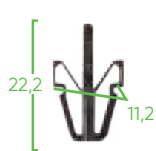

13092 1,65€ 15 15

OE 8942180270

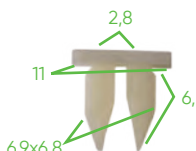

13093 2,95€ 30 30

OE 9018905013

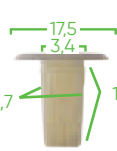

13094 1,50€ 10 10

OE MU480033



13095 1,20€ 8 6

OE 128100231



13096 1,70€ 8 8

OE MU480034



13097 1,20€ 3 3

OE MR138807

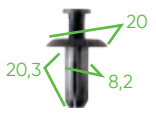

13098 1,65€ 4 4

OE MB253964

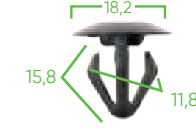

13099 2,75€ 30 30

OE HB121467



13100 1,20€ 3 3

OE MB271999



13101 1,50€ 8 8

OE MB696120

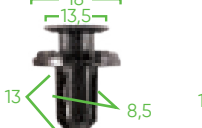

13102 1,60€ 5 5

OE MR200300



13103 1,80€ 10 10

OE MB846992

132 PCS



PARA VAUXHALL / OPEL

52898 36,00€

0,45	6	24	360
Kg	Sub	11	



13122 1,95€ 20 20

OE 90218614

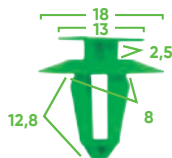

13123 5,35€ 40 40

OE 174864



13124 8,20€ 100 100

OE N0385501

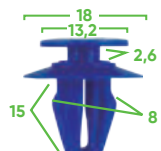

13125 5,95€ 50 50

OE 2345959



13126 1,55€ 50 50

OE 2240582



13127 5,60€ 40 40

OE 180942

300 PCS



ESTUCHES DE CLIPS PLÁSTICOS



UNIVERSAL

52888 24,00€

0,17 6 24 672
Kg SUB 11 1

128 PCS

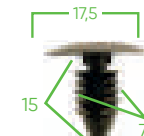
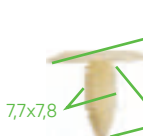
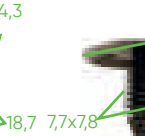
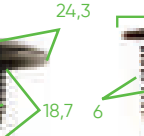
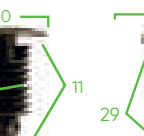
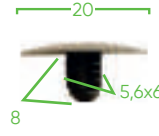
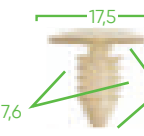
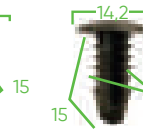
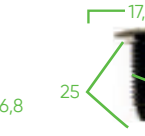

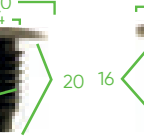
 17,5 17 7,5 13026 8 8 1,55€ OE 388577S	 17,5 15 7,6 7,7x7,8 13027 10 10 1,85€ GENERAL USE	 24,3 18,7 7,7x7,8 13028 6 6 1,45€ OE 6003423	 24,3 18,7 7,7x7,8 13029 6 6 1,65€ VW: N989022 CHRYSLER: 6003349 FORD: 385661	 10 11 6 13030 25 25 2,80€ GM: 20699808 CHRYSLER: 6502328	 21 18 11,5 29 13031 4 4 1,85€ FORD: N804379S
 20 8 5,6x6 13032 15 15 2,00€ MAZDA: 6508197AA FORD: F22Z16774A	 17,5 15 7,6 13033 10 10 1,60€ GM: 16674629 FORD: N8061135	 14,2 15 6,8 13034 20 20 2,65€ NISSAN: 0153301781	 17,6 25 7,5 13035 6 6 1,65€ GM: 10124502 BMW: 52201964201 LAND ROVER: DZM100080	 20 16 9,2 20 13036 6 6 1,40€ VW: N9020160H FORD: 6998849 BMW: 51471904317 OPEL: 2207713	 16 7x7 13037 12 12 2,10€ GENERAL USE

PARA BMW MINI PARA TAPICERÍA

53720 19,00€

0,20 6 24 672
Kg SUB 11 1

112 PCS



 20 10 14 14447 7 6 1,45€ OE 51471911992	 15 7,3 15 14449 13 10 2,20€ OE A0009905492	 18 6,7 17,8 14471 5 5 1,90€ OE 51717002953	 22 10 10 14472 5 5 1,35€ OE 51489119216	 18,5 7,5 16 14474 8 8 1,50€ OE 51118174185	 24 5 10 14475 6 6 1,65€ OE 2019900050
 12 11,5 20 7,2 14476 9 9 2,05€ OE 51481915964	 9,9x9,6 14 6,6x7,2 14477 15 15 2,45€ OE 0009881625	 7x6,7 14 14478 15 15 4,05€ OE 7146976114	 20 10 14,5 14479 6 6 1,65€ OE 91503SP0003	 10 5 11,6 14480 15 15 2,05€	 15 8,8 8 14481 8 8 1,70€ OE 51161943122

PARA BMW MINI PARA PANEL DE PUERTA / MOLDURA

53719 19,00€

0,15 6 24 672
Kg SUB 11 1

92 PCS

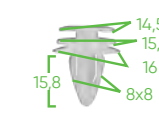
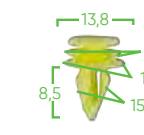
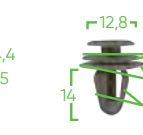
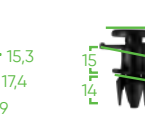
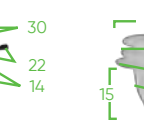
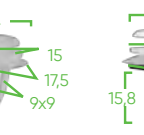
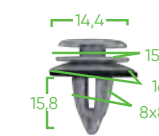
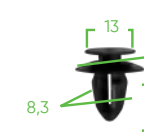
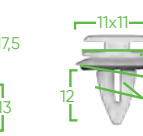
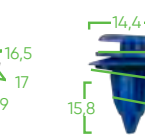
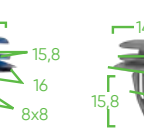
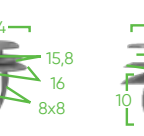

 14,5 15,8 16 15,8 8x8 14359 8 4 1,05€ OE 51418224768	 13,8 14,4 15,5 15,7 8,5 14458 8 8 1,70€	 12,8 15,3 17,4 9 14 14459 6 6 1,45€	 30 15 22 14 15 14 14460 2 2 1,15€ OE 7147122912	 14 15 17,5 9x9 14461 8 8 1,35€ OE 51411973500	 14,4 15,8 16 8x8 14462 8 8 1,65€
 14,4 15,8 16 8x8 15,8 14463 8 8 1,65€	 13 17,5 13 8,3 14464 10 10 1,50€ OE 611769	 11x11 16,5 17 9 12 14465 10 10 2,00€ OE 7147145753	 14,4 15,8 16 8x8 15,8 14466 8 8 1,65€	 14,4 15,8 17,5 8x8 15,8 14468 8 8 1,30€	 14,5 16 17,5 7,7 10 14469 8 8 1,45€ OE 7147133419

ESTUCHES DE CLIPS PLÁSTICOS

UNIDADES EN EL ESTUCHE



UNIDADES POR BOLSA RECAMBIO



BOLSAS POR SUBCAJA/CAJA

10 100

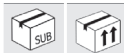

DESPIECE DISPONIBLE

PARA MERCEDES-BENZ PARA TAPICERÍA

53718 19,00€

0.20	6	24	672
Kg			

 9	 5	 11,3	 9	 7,3	 6
14422 6 6 1,50€	14446 20 20 2,80€	14447 6 6 1,45€	14448 12 12 2,05€	14449 10 10 2,20€	14450 12 12 2,15€
OE A0009913940	OE 9903492	OE 51471911992	OE N105835019B9	OE A0009905492	OE N0385012
 8,7	 6	 4,8	 6	 8	 7,6x7,6
14451 12 12 2,15€	14452 25 25 2,55€	14453 20 20 3,05€	14455 12 12 2,10€	14456 6 6 1,35€	14457 10 10 1,70€
OE A1239900092					OE A1249900492

151 PCS



PARA MERCEDES-BENZ PARA PANEL DE PUERTA / MOLDURA

53717 19,00€

0.15	6	24	672
Kg			

 9	 8,1x8,9	 9x8,5	 9x8,5	 8x8	 8
14434 8 8 1,60€	14435 6 6 1,45€	14436 8 8 1,70€	14437 6 6 1,45€	14438 8 8 1,35€	14439 8 8 1,75€
OE A0009910198		OE A0019912698	OE A0089880978	OE 0069884378	
 9,3	 8	 9x8,5	 8,2x8,2	 7,7	 7,2x8
14440 8 8 1,75€	14441 10 10 1,65€	14442 6 6 1,45€	14443 8 8 1,45€	14444 10 10 1,90€	14445 10 10 1,45€
OE 0019884981			OE 0019886081		

96 PCS



PARA VAG / SEAT / SKODA PARA PUERTA / MOLDURA / TAPICERÍA

53716 19,00€

0.15	6	24	672
Kg			

 9	 5,7	 12,5	 30	 4	 12
14422 6 6 1,50€	14423 15 15 3,55€	14424 7 7 1,85€	14425 2 2 2,05€	14426 8 8 1,90€	14427 8 4 1,20€
OE A0009913940	OE 6E0837732	OE 6Q0868243	OE 171201969	OE 4D0807300	
 8,15	 11	 25	 10,7	 5	
14428 12 12 1,40€	14429 6 6 1,80€	14430 3 3 2,25€	14431 2 2 1,45€	14432 10 10 1,45€	
OE 251823717		OE 8E0821989A	OE 3B0868243	OE 1H0823717	

79 PCS



ESTUCHES DE CLIPS PLÁSTICOS

PARA PEUGEOT / CITROËN PARA TAPICERÍA

53715 19,00€

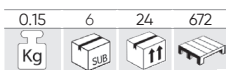

110 PCS



14410 10 10
1,85€



14411 10 5
1,70€

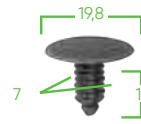

14412 10 10
1,70€



14413 10 10
3,25€



14414 10 10
1,70€
OE 2346824



14415 10 10
1,70€
OE A1249900492

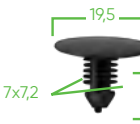

14416 10 5
1,25€
OE 6992C6



14419 15 15
1,95€



14420 15 15
1,50€



14421 10 10
2,45€
OE 14093311

PARA PEUGEOT / CITROËN PARA PANEL DE PUERTA

53713 16,00€



93 PCS



14350 6 6
1,80€
OE 6991Y8

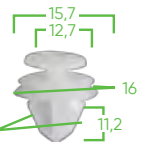

14358 10 10
1,70€
PEUGEOT: 6991Y8
CITROËN: 6991Y8
FIAT: 9654280780
RENAULT: 7703077469

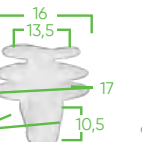

14387 8 8
1,45€

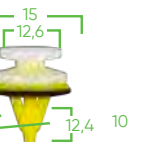

14388 8 8
2,05€
OE 7703077250



14389 6 6
1,25€
OE 6995A3

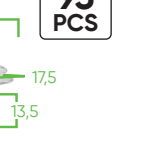

14390 6 6
1,35€



14391 15 15
2,15€

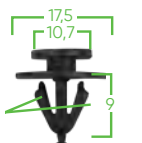

14392 6 6
1,35€

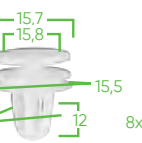

14393 8 8
1,50€

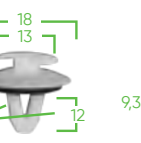

14395 8 8
1,65€

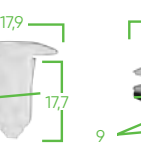

14396 6 6
1,20€

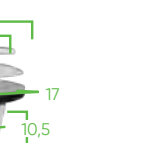

14397 6 6
1,45€

PARA PEUGEOT / CITROËN PARA MOLDURA

53714 16,00€

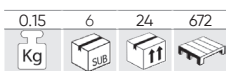

80 PCS

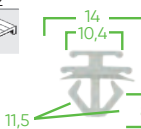

14398 8 8
1,30€
OE 6995X3

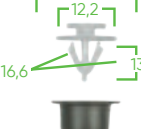

14399 6 6
1,90€
OE 129943

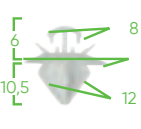

14402 8 8
1,50€
OE 856548

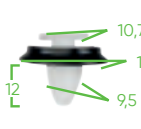

14404 8 8
2,10€
OE 71728806



14405 16 8
1,45€
OE 968865987703



14406 10 10
1,55€
OE 856540



14408 10 10
1,45€
OE 856534

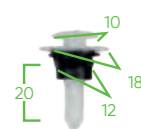

14409 8 8
1,35€
OE 357853586

ALICATE PARA EXTRACCIÓN DE GRAPAS DE CARROCERÍA

53385 19,30€

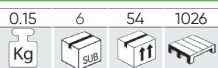

IVA no incluido

SET DE 2 PALANCAS EXTRACCIÓN GRAPAS

52851 9,65€

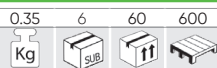

JBM / www.jbmcamp.com

SET DE 6 PALANCAS

53110 27,30€



6 PCS

5"x8.5 / 5"x10.3
5"x4.5 / 15"x8.5
15"x10.3 / 15"x4.5mm



343

PARA RENAULT / DACIA PARA TAPICERÍA

53712 16,00€

0,15	6	24	672
Kg	Sub	Paq	Paq

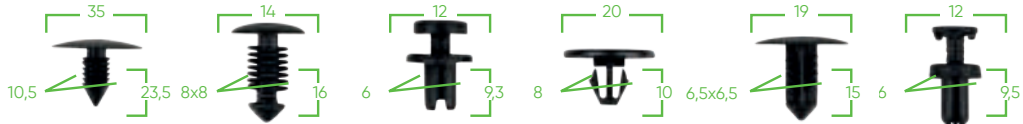

14374 1,70€ OE 7703077435	14375 1,85€ OE 7703077435	14376 2,60€ OE 7L6868307	14377 1,90€ OE 7703077435	14378 1,90€ OE 7703077117	14379 1,45€ OE 7703077117
--	--	---------------------------------------	--	--	--

14381 1,70€ OE 7703072360	14383 1,35€ OE 7703072360	14382 1,85€ OE 7703077153	14384 2,10€ OE W705956S300	14416 1,25€ OE 6992C6
--	--	--	---	------------------------------------



PARA RENAULT / DACIA PARA MOLDURA

53711 16,00€

0,20	6	24	672
Kg	Sub	Paq	Paq

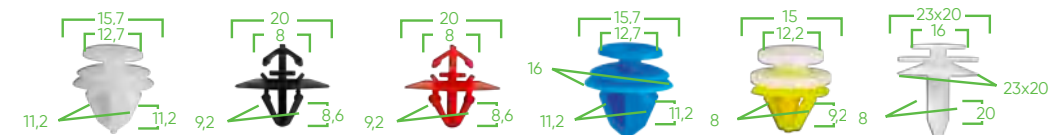

14358 1,70€ PEUGEOT: 6991Y8 CITROËN: 6991Y8 FIAT: 9654280780 RENAULT: 703077469	14364 1,90€ OPEL: 7701470779 NISSAN: 7703077421 RENAULT: 7703077421	14365 1,90€ OPEL: 7701470779 NISSAN: 7703077421 RENAULT: 7703077421 IVECO: 500326896	14366 1,45€ RENAULT: 7703077368 OPEL: 4430858	14356 1,90€ OE 7L5853994	14367 1,30€ OE 7L5853994
---	--	--	---	---------------------------------------	---------------------------------------

14368 1,45€ OE 7701061797	14369 4,95€ OE 7701061797	14371 3,00€ OE 7701061797	14370 3,00€ OE 7701061797	14372 1,20€ OE 7701061797	14373 1,35€ OE 7701061797
--	--	--	--	--	--



PARA RENAULT / DACIA PARA PANEL DE PUERTA

53710 16,00€

0,20	6	24	672
Kg	Sub	Paq	Paq

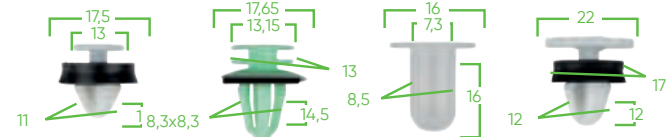

14350 1,80€ OE 6991Y8	14351 1,65€ OE 51447780135	14352 1,30€ OE 51447780135	14353 2,10€ OE 7703077476
------------------------------------	---	---	--

14355 1,70€ OE 7703077354	14356 1,90€ OPEL: 4430858 RENAULT: 7703077368	14357 1,90€ OE 7703077430	14358 1,70€ OE 51418224768
--	---	--	---

14359 1,05€ OE 7703077469	14368 1,45€ OE 7703077469	14359 1,05€ OE 7703077469
--	--	--



PÓSTER CLIPS

15001 3,00€

- Conjunto de 2 pósters informativos de los clips plásticos JBM. Con toda la información de cada clip (referencia, precio, medidas).



330x1000mm



JBM®

ROPA LABORAL

346 CHALECOS / CHAQUETAS

CHALECOS JBM

TALLA L

70002 37,50€

0.40 - 5 200
Kg SUB

TALLA S

70013 44,00€

0.30 - 10 240
Kg SUB

TALLA L

70015 44,00€

0.30 - 10 240
Kg SUB

TALLA XL

70003 37,50€

0.40 - 5 200
Kg SUB

TALLA M

70014 44,00€

0.30 - 10 240
Kg SUB

TALLA XL

70016 44,00€

0.35 - 10 240
Kg SUB

TALLA XL

70009 37,50€

0.40 - 5 180
Kg SUB

TALLA XXL

70017 44,00€

0.35 - 10 240
Kg SUB



70002, 70003



2 BOLSILLOS INTERIORES DE GRAN CAPACIDAD

70007, 70009



2 BOLSILLOS LATERALES

70013, 70014, 70015, 70016, 70017



Resistente al frío

Térmica

Ligera

CHAQUETAS JBM

TALLA L

70005 42,00€

0.70 - 5 140
Kg SUB

70011 42,00€

0.60 - 5 120
Kg SUB

TALLA XL

70012 42,00€

0.70 - 5 120
Kg SUB



CUELLO ELEVADO ALTO Y CON CREMALLERA DELANTE



3 BOLSILLOS EXTERIORES



Resistente al frío

Térmica

Ligera



490mm

PERCHA

13929 3,45€

0.10 - - 280
Kg SUB



EXPOSITOR JBM

METEXP 62,00€

6.00 - 1 25
Kg SUB



PROMOCIONALES

348 PRODUCTOS PROMOCIONALES
352 EXPOSITORES Y ACCESORIOS
354 PACKAGING

CÁMARA DEPORTIVA

53865 48,00€

0,30 - 36 432



- ✓ Una **carcasa resistente al agua** que le permite uso hasta **30 metros bajo el agua**.
- ✓ **Pantalla LTPS LCD** de alta definición.
- ✓ Batería fácil de desmontar.
- ✓ Grabación de video digital, fotos, visualización de video y grabación de audio.
- ✓ **Lente angular HD de 120°**.
- ✓ **Cámara web**.
- ✓ Admite tarjetas de almacenamiento de hasta **64GB**.
- ✓ **Múltiples formatos** de grabación.
- ✓ **Detección de movimiento y grabación cíclica**.



GRABACIÓN DE ALTA DEFINICIÓN

DISEÑADO PARA:

- Deportes al aire libre
- Grabar des del vehículo
- Hacer fotos
- Sondeo en aguas profundas



ACCESORIOS:



SILLA GIRATORIA

53956 353,00€

21,50 - 1 4



- ✓ **Material:** Poliuretano
- ✓ **Grosor estructura de acero:** 1,2cm
- ✓ **Espuma del asiento:** Espuma moldeada
- ✓ **Espuma del respaldo:** Espuma primaria
- ✓ **Apoyabrazos:** 2D
- ✓ **Piston elevador de gas:** Clase 3
- ✓ **Base de nylon:** 350mm

COJÍN REPOSACABEZAS

MEDIDAS 70X55X126-136CM

200Kg



PATAS PARA SILLA GIRATORIA

15256 1,85 Kg
36,00€

REPOSABRAZOS DERECHO

15257 1,35 Kg
27,50€

REPOSABRAZOS IZQUIERDO

15258 1,35 Kg
27,50€

AMORTIGUADOR

15259 0,85 Kg
18,00€

SET DE 5 RUEDAS

15260 0,60 Kg
22,50€

CARPA STAND JBM 3x3m

53973 284,00€

18,40 - 1 31



LATERAL PARA REF. 53973

15152 160,00€

2,25 - 5 -



- Consta de dos partes:
- Parte lateral que cubre 3/4 partes de la carpa.
 - Parte delantera que cubre 1/4 parte de la carpa. Con cremallera vertical a modo de puerta.



INCLUYE FUNDA PARA CARPA:

14347 36,50€

0,60 - 5 -

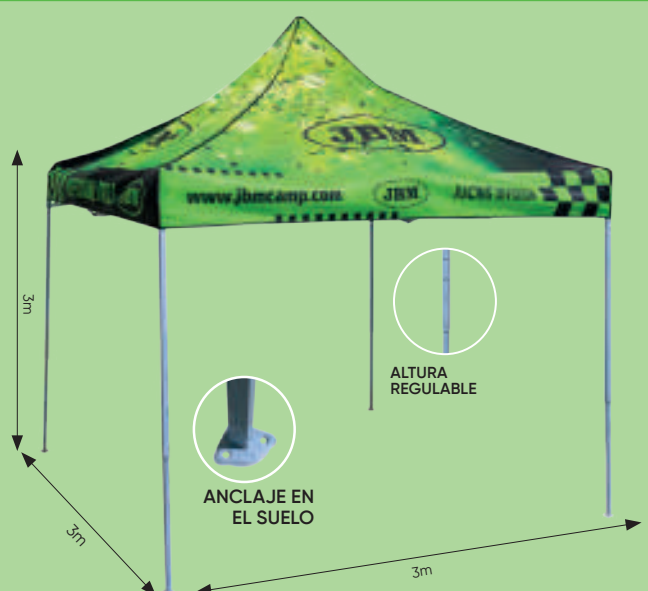

ROBOT ASPIRADOR

54020 288,00€



Este robot inteligente realiza de forma automática tareas de **aspiración y fregado**. Gracias a su sistema de mapeo inteligente puede realizar una limpieza exhaustiva de la zona de trabajo. Es altamente configurable ya que le permite elegir entre diferentes modos de funcionamiento, ajustar niveles de aspiración y humedad y programar tareas para horas determinadas.



CONEXIÓN APP



ESTACIÓN BASE PARA REF.54020

15346 24,00€

TRANSFORMADOR DE CORRIENTE

15349 8,50€

4-5H 100-180min 14.8V 2600mAh



3,4kg 68 dB 20cm/s 1200 Pa

20W

Máxima superficie cubierta
Maximum covered area
120m²

Capacidad tanque de agua
Water tank capacity
300ml

Capacidad del depósito de polvo
Dust box capacity
300ml

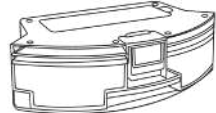

CEPILLO LATERAL IZQUIERDO

15340 5,50€



CEPILLO LATERAL DERECHO

15341 5,50€

CEPILLO PRINCIPAL

15342 9,00€

FILTRO HEPA

15343 9,50€

CEPILLO DE LIMPIEZA

15344 6,50€

JUEGO DE 5 MOPAS

15345 10,50€

MOCHILA JBM

54043 48,00€

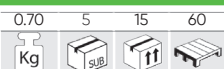

- ✓ **Espacio de almacenamiento:** Con un total de dos compartimentos tiene capacidad para ordenadores portátiles de menos de 17.3 pulgadas y tablets, entre otros.
- ✓ **Material:** Poliuretano, es una mochila impermeable, sólida y resistente
- ✓ **Ligera y cómoda:** Diseño de malla de esponja cómoda y transpirable de la espalda y las correas.



CAMISETA POLO JBM

REF.	TALLA	Kg	Sub	Up	€
13243	M	0,25	100	600	12,50€
13244	L	0,26	100	600	12,50€
13245	XL	0,28	100	600	12,50€



BOLSA PROMOCIONAL JBM

13968 1,35€

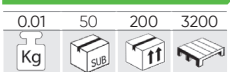

TAZA JBM

54076 9,00€



IVA no incluido

BOLÍGRAFO DE 4 COLORES PUBLICITARIO JBM

53533 1,50€

0.01	50	1000	12000
Kg	Sub	Up	Down



- Bolígrafo de 4 colores: azul, rojo, negro, verde.



CON PUNTERO TRASERO DE GOMA PARA ESCRIBIR EN PANTALLAS TÁCTILES

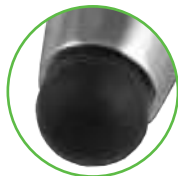

PANTALLA DISTRIBUIDOR JBM

15789 2.545,00€

40.50	-	1	6
Kg	Sub	Up	Down

La pantalla promocional JBM es el futuro de la publicidad de tu negocio. Dispone de un panel LCD de 43" con tecnología LED, gracias a su diseño será el centro de atención, para impactar a los clientes potenciales. Las imágenes y vídeos en constante cambio garantizarán una fuerte atracción sobre el público. A diferencia de la publicidad convencional en vallas, rótulos, etc; la publicidad en las pantallas LED es muy dinámica. Gracias a sus características aportará grandes beneficios a tu tienda.



FREIDORA DE AIRE

54171 138,00€

4.90	-	2	18
Kg	Sub	Up	Down

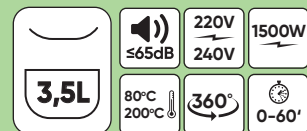

BICICLETA ESTÁTICA

53930 276,00€

29.00	-	1	5
Kg	Sub	Up	Down

- Tiempo: 0:00~99:59 min
- Distancia: 0.00~9999 ml (km)
- Distancia total: 0.00~9999 ml (km)
- Velocidad: 0.0~9999
- Calorías: 0.0~9999 kcal
- Pulso: 40~240 bpm
- Batería: tamaño-AAA *2



SILLÍN DE GRAN COMODIDAD



CON RUEDAS PARA FACILITAR SU TRANSPORTE

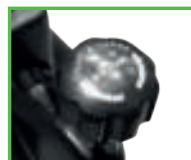

AJUSTE DE FUERZA



BUEN AGARRE



FUNCIONES DE LA COMPUTADORA:

- TIEMPO
- VELOCIDAD
- DISTANCIA
- CALORIAS
- ODÓMETRO
- PULSO
- ESCANEO

PATINETE DE 2 RUEDAS SCOOTER

53504 38,00€

3.50	-	6	36
Kg	Sub	ff	ff

77mm 100mm



CINTA DE CORRER

53934 690,00€

0.25	10	40	1480
Kg	Sub	ff	ff

1160mm 1450mm 675mm

110 KG

- Pantalla: 3.5" LED
- Función: Corriendo, Masaje, Sit-up
- Potencia nominal: 550W
- Potencia máxima: 1500W (2.0HP)
- Velocidad: niveles 1.0 - 12 (velocidad máxima 9.5 km/h)
- Tamaño de plegado: 970x675x1275 mm

FUNCIONES DE LA PANTALLA:

- TIEMPO
- DISTANCIA
- VELOCIDAD
- CALORIAS
- PULSO

PLEGABLE



BARBACOA CON PARRILLA

53931 104,00€

6.10	-	1	18
Kg	Sub	ff	ff



- Material: hierro y alambre.
- Grosor: 0.4mm.
- Acabado: pintura anticorrosiva negra.
- Parrilla de cocina: 43x40cm, cromada.
- Parrilla de carbón: 36x36cm, zincada.
- Altura: 59 cm.
- Patas: de acero inoxidable 430, 19mm de diámetro.



UNA PARRILLA DE COCINA, UNA PARRILLA DE CARBÓN Y UNA PARRILLA PARA CALENTAR

ESCAPE DE HUMO EN LA TAPA

810mm 450mm



TAPA CON RECUBRIMIENTO DE PINTURA ANTICORROSIVA



PATAS DE ACERO INOXIDABLE

JAMONERO

14975 64,00€

2.95	-	4	80
Kg	Sub	ff	ff

- Dimensiones: 500x330x440mm
- Peso: 2,18kg



SET DE 3 CUCHILLOS

53511 23,00€

0.65	5	20	360
Kg	Sub	ff	ff



3 PCS

BOLSA NEVERA JBM

53949 4,50€

0.10	-	15	540
Kg	Sub	ff	ff

350mm 675mm 675mm



CUBERTERÍA

53512 41,00€

1.90	-	12	144
Kg	Sub	ff	ff



24 PCS

PARAGUAS PROMOCIONAL JBM

52857 7,50€

0.31	10	60	600
Kg	Sub	ff	ff

84mm



COLLAR PERLA

53513 9,00€

0.05	9	495	5940
Kg	Sub	ff	ff



SET DE 2 TOALLAS

53510 24,00€

0.65	-	25	100
Kg	Sub	ff	ff



2 PCS

IVA no incluido

JBM www.jbmcamp.com

351

EXPOSITOR DE HERRAMIENTAS VACÍO

53877 430,50€

42,00	-	1	-
Kg	Sub	Paq	Paq

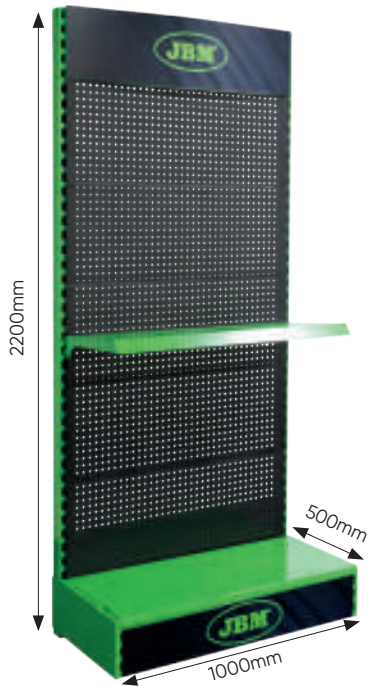

CONTIENE

14945 x1



11318 x20



14380 x1

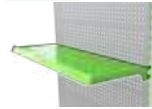

14946 x1



DESPIECE EXPOSITORES

14946 58,00€

CABEZAL PARA EXPOSITOR DE HERRAMIENTAS

3,40	-	1	48
Kg	Sub	Paq	Paq

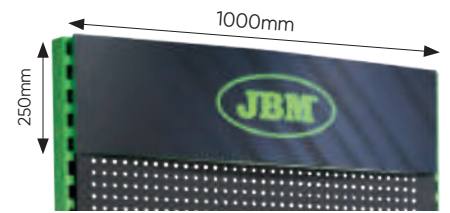

14947 201,50€

CABEZAL CON ILUMINACION PARA EXPOSITOR DE HERRAMIENTAS

8,55	-	1	6
Kg	Sub	Paq	Paq

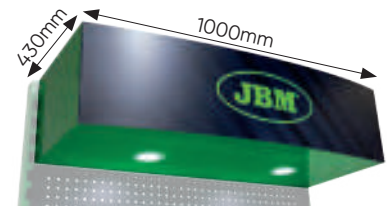

14380 51,00€

BANDEJA PARA EXPOSITOR DE HERRAMIENTAS 53877

5,00	-	1	27
Kg	Sub	Paq	Paq

2 posiciones

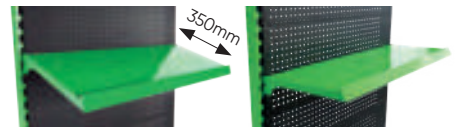

EXPOSITOR DE HERRAMIENTAS + CABEZAL CON ILUMINACIÓN

53878 574,00€

52,15	-	1	-
Kg	Sub	Paq	Paq



EXPOSITOR + CABEZAL CON ILUMINACIÓN Y PUERTAS

53879 838,50€

83,25	-	1	-
Kg	Sub	Paq	Paq



CONTIENE

14945 x1



14380 x1

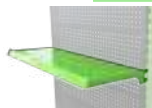

14947 x1



11318 x20



CONTIENE

14945 x1



14948 x1



11318 x20



14996 x1

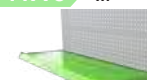

14947 x1



14996 65,00€

BANDEJA PARA EXPOSITOR DE HERRAMIENTAS CON PUERTA

5,00	-	1	33
Kg	Sub	Paq	Paq

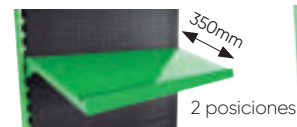

2 posiciones



14948 251,50€

CONJUNTO DE DOS PUERTAS PARA EXPOSITOR DE HERRAMIENTAS

31,10	-	1	40
Kg	Sub	Paq	Paq

14945 303,50€

EXPOSITOR DE HERRAMIENTAS

37,80	-	1	14
Kg	Sub	Paq	Paq



BANDEJA SOPORTE

14622

17,00€

PARA REF. 60001, 60003, 60004, 60020

0,95	-	10	360
Kg	Sub	ff	ff

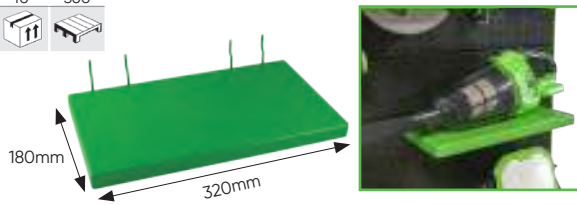

14624

17,00€

PARA REF. 60007, 60010, 60011

0,65	-	10	300
Kg	Sub	ff	ff

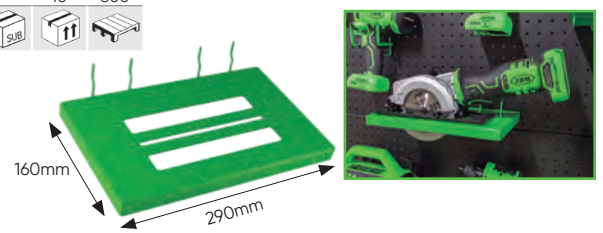

GANCHOS

14626

7,00€

PARA REF. 60023

0,10	-	10	-
Kg	Sub	ff	ff

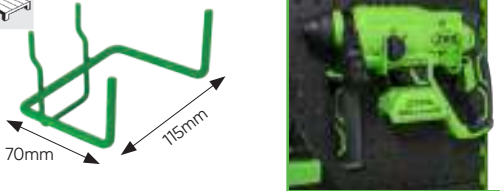

14623

8,00€

PARA REF. 60005, 60006, 60018

0,10	-	10	800
Kg	Sub	ff	ff

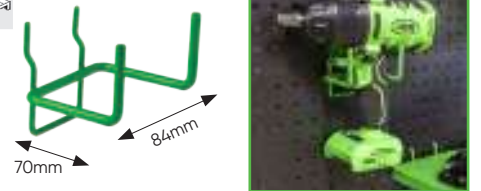

GANCHOS

DE PUNTA

11318

2,50€

0,04	20	600	-
Kg	Sub	ff	ff



DE PUNTA CERRADA

51315

2,50€

0,02	20	320	44800
Kg	Sub	ff	ff



PARA HERRAMIENTA NEUMÁTICA

14034

9,00€

0,20	20	80	1920
Kg	Sub	ff	ff



SOPORTE PARA REF. 60008, 60009

14625

14,00€

0,50	-	10	700
Kg	Sub	ff	ff

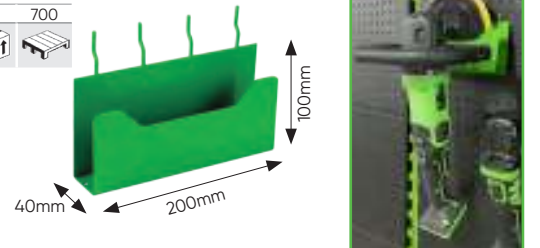

EXPOSITOR DE HERRAMIENTA NEUMÁTICA

53492

380,00€

HERRAMIENTAS NO INCLUIDAS

13,00	-	1	7
Kg	Sub	ff	ff



EXPOSITOR DE ALFOMBRAS JBM

METEXP

62,00€

6,00	-	1	25
Kg	Sub	ff	ff



IVA no incluido

POSTE DE SEPARACIÓN CON CINTA RETRÁCTIL

53914 75,00€

8.50	-	5	90
Kg	sub	ff	



- Material: Acero
- Diámetro del tubo: 63mm
- Diámetro de la base: 320mm
- Altura: 910mm

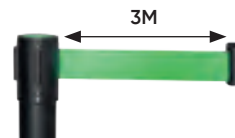

- Salida de cinta en 4 direcciones
- Largo de la cinta: 3m
- Ancho de cinta: 48mm

SALIDA DE CINTA EN 4 DIRECCIONES

CAJAS PARA DESPIECE HERRAMIENTA MANUAL

REF.	cm	Kg	ff	€
14922	14,5x9x10	0,10	100	0,84€
14923	17,5x9x7	0,10	100	0,84€
14924	24x11x7	0,10	100	0,84€
14925	31,5x13x4	0,10	100	0,84€
14926	32x8,5x7	0,10	100	1,05€



PRECINTO DE GARANTÍA JBM

14807 11,00€

0.45	6	24	864
Kg	sub	ff	

- 75mm ancho x 125m largo
- Fabricado en Polipropileno
- Adhesivo solvente
- Grosor: 28 micras



MULTI IDIOMA

CAJA CARTÓN LOTE PROMOCIONAL NAVIDAD

REF.	cm	Kg	ff	€
14976	80x31x61	2,20	1 80	18,84€
15056	40x30x61	1,60	1 70	11,70€
13717	76x14x29	0,90	1 200	7,65€
14083	80x28x49	1,80	1 100	13,20€



14083



13717



14976



15056



CAJAS DE CARTÓN JBM



12950



14189

14507

REF.	cm	Kg	ff	€
11330	19x10x11	0,05	50 4.200	0,57€
12952	40x30x20	0,40	30 360	1,92€
15051	40x32x30	0,40	20 160	1,92€
14974	54x24x40	0,65	20 150	2,28€
13217	57x30x25	0,55	15 150	1,31€
12950	60x40x30	0,80	15 75	3,45€

REF.	DESCRIPCIÓN	Kg	ff	€
14189	Pallet box americano triple canal 120x80x100cm	10	1 40	52,00€
14507	Pallet box europeo 120x98x80cm	8	1 40	50,00€















LEYENDA



CARACTERÍSTICAS GENERALES







							
Peso kilogramos	Cantidad por subcaja	Cantidad por expositor	Cantidad por bolsa	Cantidad por caja	Cantidad de bolsas por caja	Cantidad por palet	Blister
							
Imantado	Peso que soporta el artículo	Nivel de ruido (decibelios)	Peso	Zoom	Conexión bluetooth	conexión USB	

MATERIALES

							
Madera	Acero	PVC	Cromado	Latón	Cobre	Neodimio	Aluminio
							
Nylon	Polipropileno	Albañilería	Cincado	Cromo vanadio	Cromo molibdeno		



HERRAMIENTAS

							
Vaso cuadrado	Vaso 12 cantos	Vaso hexagonal	Vaso punta XZN	Vaso twist	Vaso spline	Punta slotted	Punta ribe
							
Punta phillips	Punta pozidriv	Cuatri punta	Punta torx inviolable	Punta inviolable - XZN	Punta torx	Tri punta	Punta TS 5 puntas
							
Punta de 12 cantos	Punta tensor	Allen inviolable	Punta mariposa	Punta allen	Punta allen inviolable	Cabota normal	Cabota redonda



PRODUCTOS NEUMÁTICOS

							
Revoluciones por minuto general	Revoluciones por minuto adelante	Revoluciones por minuto inversa	Newtonmetro(Nm) / Kilogramos(Kg)	Libra por pulgada cuadrada	Unidad de presión (Bar)	Entrada de aire	Salida trasera
							
Salida trasera de 360°	Salida delantera	Salida delantera	Salida delantera	Medidas	Mango ergonómico	Órbita del disco	Diámetro de disco
							
Tamaño broca	Medida entrada taladro	Movimientos en 360°	N° de velocidades	Caballos de fuerza	Mecanismo doble martillo	Ángulo de 90°	

LEYENDA



ILUMINACIÓN

Tipo de Led: SMD	Tipo de Led: COB	Tipo de Led: Cree XP-E	Cantidad / potencia Leds	Cantidad de Leds	Distancia de iluminación	3 intensidades de luz	Flujo luminoso (Lumen)
Luz dispersa	Luz concentrada	Cantidad de tipos de flash	Potencia Volts/Watts	Duración de la batería	Duración de carga	Tipo de batería	Cantidad de pilas AAA
Transformador / toma de pared	Cargador con USB	Toma de mechero	Base reclinable	Base reclinable	Colgador	Colgador giratorio	Largo de cable



CERTIFICADOS

Certificado CE

Normativa herramientas aisladas

Normativa conforme a los guantes de protección



UTILLAJE



Compresor de muelles



Desmontaje de amortiguadores



ACCESORIOS LUBRICANTES



Capacidad de embudo



Caudal



ÍNDICE NUMÉRICO

REF.	Pg.	PVP	REF.	Pg.	PVP	REF.	Pg.	PVP	REF.	Pg.	PVP
10054	192	2,90€	10569	38	4,50€	10674	205	9,50€	10831	329	0,20€
10055	192	3,90€	10570	38	4,50€	10675	205	9,50€	10832	329	0,20€
10485	193	8,10€	10571	38	5,00€	10720	280	24,50€	10833	329	0,20€
10486	193	8,00€	10579	38	3,00€	10721	280	19,00€	10834	329	0,25€
10494	193	6,50€	10580	38	3,10€	10722	280	24,50€	10835	329	0,25€
10495	193	3,00€	10581	38	3,40€	10723	280	29,50€	10836	329	0,30€
10496	193	3,00€	10582	38	4,00€	10724	280	29,50€	10837	329	0,30€
10497	193	3,00€	10583	38	4,15€	10731	79	17,60€	10838	329	0,30€
10498	193	3,00€	10584	38	5,05€	10732	79	18,70€	10839	329	0,40€
10499	193	3,00€	10585	38	6,75€	10733	79	17,50€	10840	329	0,35€
10500	193	3,00€	10586	38	7,60€	10735	79	20,30€	10868	333	0,30€
10501	193	8,10€	10587	38	9,80€	10750	124	13,00€	10869	333	0,30€
10502	193	3,50€	10588	38	10,50€	10751	124	15,00€	10870	333	0,45€
10527	36	13,10€	10589	38	2,00€	10761	280	16,00€	10871	333	0,30€
10528	36	15,80€	10590	38	2,40€	10762	280	23,50€	10872	333	0,40€
10529	36	18,00€	10591	40	2,50€	10766	124,130	1,59€	10873	333	0,45€
10530	36	28,70€	10592	40	2,55€	10767	252	21,00€	10874	333	0,30€
10531	37	3,00€	10593	40	3,15€	10768	261	113,00€	10875	333	0,40€
10532	37	2,70€	10594	40	3,20€	10769	261	21,00€	10876	333	0,45€
10533	37	3,00€	10595	40	3,35€	10770	261	6,00€	10877	327	0,25€
10534	37	3,25€	10596	40	4,25€	10772	328	0,05€	10878	327	0,30€
10535	37	3,50€	10597	40	4,50€	10773	328	0,10€	10879	327	0,20€
10536	37	3,65€	10598	40	4,60€	10774	328	0,10€	10880	327	0,20€
10537	37	3,90€	10599	40	6,00€	10775	328	0,15€	10881	327	0,25€
10538	37	4,30€	10600	40	6,25€	10776	328	0,20€	10882	325	0,25€
10539	37	4,75€	10601	40	6,50€	10777	328	0,20€	10883	325	0,25€
10540	37	5,25€	10602	40	7,05€	10778	328	0,35€	10884	325	0,25€
10541	37	5,55€	10603	40	2,10€	10779	326,328	0,05€	10885	335	0,20€
10542	37	5,85€	10604	40	2,25€	10780	326,328	0,05€	10886	335	0,20€
10543	37	7,00€	10617	36	14,10€	10781	326,328	0,05€	10887	335	0,25€
10544	37	8,10€	10618	36	15,10€	10782	328	0,05€	10888	335	0,30€
10545	37	9,75€	10619	36	15,70€	10783	328	0,05€	10889	335	0,30€
10546	37	11,60€	10620	36	16,20€	10784	326	0,05€	10890	335	0,35€
10547	37	13,50€	10621	36	9,50€	10785	326,328	0,10€	10891	335	0,25€
10548	37	1,75€	10622	36	10,00€	10786	326,328	0,15€	10892	335	0,30€
10549	37	2,00€	10623	36	12,60€	10787	328	0,05€	10893	335	0,25€
10550	37	2,15€	10624	36	13,50€	10788	328	0,05€	10894	335	0,20€
10551	37	2,15€	10625	36	15,70€	10789	328	0,05€	10895	335	0,20€
10552	34	7,10€	10626	36	17,80€	10790	328	0,05€	10896	335	0,30€
10553	34	7,35€	10627	39	2,80€	10791	328	0,05€	10897	335	0,30€
10554	34	7,50€	10628	39	3,10€	10792	328	0,05€	10898	335	0,30€
10555	34	7,80€	10629	39	3,65€	10793	325	0,25€	10899	335	0,30€
10556	34	8,10€	10630	39	3,90€	10794	325	0,40€	10900	335	0,30€
10557	34	8,10€	10631	39	4,20€	10795	325	0,60€	10901	335	0,25€
10558	34	9,35€	10632	39	5,30€	10805	326	0,10€	10902	335	0,30€
10559	34	9,50€	10633	39	6,60€	10812	326	0,30€	10905	335	0,25€
10560	34	10,60€	10634	39	7,80€	10813	326	0,30€	10906	335	0,25€
10561	34	11,00€	10635	39	8,15€	10823	329	0,20€	10907	335	0,25€
10562	34	12,30€	10636	39	8,80€	10824	329	0,20€	10908	335	0,30€
10563	34	12,50€	10637	39	12,10€	10825	329	0,20€	10909	335	0,30€
10564	38	2,50€	10638	39	12,70€	10826	329	0,40€	10910	335	0,30€
10565	38	3,50€	10639	261	10,90€	10827	329	0,60€	10911	335	0,30€
10566	38	3,50€	10671	270	15,20€	10828	329	0,45€	10912	335	0,25€
10567	38	3,50€	10672	205	9,50€	10829	329	0,20€	10913	335	0,30€
10568	38	4,00€	10673	205	9,50€	10830	329	0,20€	10914	335	0,25€

REF.	Pg.	PVP	REF.	Pg.	PVP	REF.	Pg.	PVP	REF.	Pg.	PVP
10915	334,335	0,25€	11152	155	57,00€	11318	353,352	2,50€	11891	313	0,50€
10916	335	0,30€	11153	154,155	23,40€	11323	267	16,00€	11892	270	12,50€
10917	334,335	0,30€	11154	155	21,70€	11324	124	17,50€	11893	190	7,00€
10918	334,335	0,30€	11155	154,155	24,40€	11325	124	17,50€	11894	190	7,00€
10919	334,335	0,30€	11156	155	28,90€	11328	298	4,00€	11895	190	8,65€
10920	334,335	0,25€	11157	155	26,60€	11329	276	564,00€	11896	190	8,80€
10921	334,335	0,30€	11158	154,155	28,50€	11330	354	0,57€	11897	172	155,00€
10923	119	1,10€	11159	155	30,30€	11360	28	2,60€	11900	310	3,50€
10925	252	18,00€	11160	155	27,00€	11362	28	5,20€	11901	310	2,50€
10945	298	2,30€	11161	155	32,30€	11363	28	3,90€	11902	310	3,50€
10953	195	12,50€	11162	155	29,10€	11364	28	4,50€	11903	310	5,00€
10955	178	11,00€	11163	155	32,70€	11365	28	9,40€	11904	310	2,00€
10961	120	13,00€	11164	155	30,70€	11374	178	5,50€	11905	310	1,50€
10962	264	85,00€	11165	155	34,60€	11375	178	6,50€	11906	310	8,50€
10964	172	9,00€	11166	155	30,90€	11376	178	5,50€	11907	310	11,00€
10965	172	6,00€	11167	155	38,00€	11377	178	5,50€	11938	152	47,00€
10966	172	13,50€	11168	155	41,00€	11378	178	6,50€	11939	261	63,00€
10993	269	117,00€	11169	155	39,20€	11379	178	6,00€	11945	54	7,00€
11093	120	4,00€	11170	155	40,00€	11380	178	6,50€	11946	54	4,50€
11095	280	31,00€	11171	155	51,00€	11381	178	6,50€	11947	54	19,00€
11098	280	57,00€	11172	155	48,00€	11382	178	6,00€	11950	269	18,00€
11100	279	24,30€	11173	155	47,00€	11383	178	6,00€	11956	137	5,50€
11101	279	154,00€	11174	155	47,00€	11384	178	6,00€	11957	137	5,50€
11102	279	6,60€	11175	155	49,00€	11385	178	5,50€	11959	168	10,50€
11103	124	6,00€	11176	155	56,00€	11386	178	6,00€	11960	309,310	1,50€
11106	180	3,00€	11177	155	55,00€	11387	178	6,00€	11962	150,154	7,50€
11107	120	4,50€	11178	155	53,00€	11388	178	6,00€	11963	154	9,00€
11121	150,155	4,10€	11179	155	65,00€	11389	178	6,00€	11964	154	12,50€
	150,155	5,45€	11180	155	59,00€	11390	178	6,00€	11965	154	16,00€
11123	150,155	6,50€	11181	155	65,00€	11391	178	6,50€	11966	154	18,00€
11124	156	7,65€	11182	155	73,00€	11392	178	6,00€	11967	154	18,00€
11125	156	8,50€	11183	155	70,00€	11393	178	6,00€	11971	85	3,10€
11126	155	11,20€	11184	155	87,00€	11394	178	6,00€	11974	278	1,80€
11127	155	13,80€	11185	155	97,00€	11541	161	11,00€	11975	278	1,80€
11128	155	14,10€	11186	155	91,00€	11542	161	11,00€	11976	278	1,80€
11129	155	14,10€	11187	155	98,00€	11543	161	11,00€	11977	278	1,80€
11130	155	13,10€	11188	155	103,00€	11544	161	7,00€	11978	278	1,80€
11131	155	14,10€	11189	155	121,00€	11545	161	11,00€	11979	278	1,80€
11132	155	13,70€	11190	155	138,00€	11546	161	12,00€	11980	278	1,80€
11133	155	12,00€	11191	155	149,00€	11547	161	12,00€	11981	278	1,80€
11134	155	15,00€	11192	155	152,00€	11613	155	11,00€	11982	278	1,80€
11135	155	17,20€	11193	155	183,00€	11614	155	13,00€	11983	278	1,80€
11136	155	15,30€	11194	155	176,00€	11615	155	14,20€	11989	120	2,00€
11137	155	18,20€	11195	150,155	3,70€	11616	155	18,10€	11990	150,152	15,30€
11138	155	18,00€	11212	46	5,00€	11617	155	18,70€	11992	276	65,00€
11139	155	18,80€	11213	46	10,60€	11618	155	18,80€	11994	79	33,00€
11140	155	20,40€	11214	46	12,50€	11619	155	19,50€	11996	79	48,00€
11141	155	18,60€	11219	276	659,00€	11621	155	359,00€	11997	79	39,00€
11142	155	21,30€	11244	40	8,50€	11622	155	399,00€	11998	79	49,00€
11143	155	26,40€	11245	40	9,15€	11623	155	489,00€	12009	139	11,00€
11144	155	33,30€	11246	40	12,40€	11624	155	189,00€	12022	167,270	33,70€
11145	155	35,30€	11247	40	14,00€	11625	155	282,00€	12029	30,196	5,50€
11146	155	37,30€	11248	40	14,60€	11628	151	9,50€	12030	30,196	6,50€
11147	155	41,00€	11249	40	26,50€	11867	256	9,00€	12031	150,151,155	15,00€
11148	155	47,00€	11313	81	54,00€	11878	211	4,10€	12032	267	7,50€
11149	155	45,00€	11314	151	13,00€	11879	211	5,10€	12044	255	147,00€
11150	155	55,00€	11315	151	8,50€	11880	211	10,50€	12046	264	385,00€
11151	155	57,00€	11316	151	8,50€	11890	313	0,55€	12055	294	20,00€

REF.	Pg.	PVP	REF.	Pg.	PVP	REF.	Pg.	PVP	REF.	Pg.	PVP
12056	252	57,00€	12974	175	21,00€	13049	338	2,05€	13108	336	1,90€
12060	47	2,50€	12975	175	23,00€	13050	339	1,55€	13109	336	2,90€
12061	155	9,50€	12977	208	36,50€	13051	339	1,50€	13110	336	1,85€
12062	150, 151, 155	9,50€	12984	155	379,00€	13053	339	2,80€	13111	336	1,20€
12063	150, 151, 155	9,50€	12987	142	1,50€	13054	339	2,35€	13112	336	1,65€
12064	155,150	9,00€	12988	148	12,00€	13055	339	3,00€	13113	336	2,20€
12065	150, 151, 155	9,00€	12995	54	7,00€	13056	339	1,55€	13114	336	2,20€
12066	150, 151, 155	9,00€	12996	54	7,00€	13057	339	1,50€	13115	336	2,50€
12067	155,150	9,50€	12997	54	7,50€	13058	339	2,20€	13116	340	5,45€
12068	150, 151, 155	9,50€	12998	54	9,00€	13059	339	2,35€	13117	340	3,65€
12069	150, 151, 155	9,50€	12999	54	9,50€	13060	339	1,60€	13118	340	15,90€
12070	150, 151, 155	10,50€	13002	336	1,45€	13061	339	2,65€	13119	340	5,60€
12071	150, 151, 155	11,00€	13003	336	1,70€	13062	339	2,35€	13120	340	5,50€
12072	150, 151, 155	12,00€	13004	336	1,85€	13063	339	1,15€	13121	340	8,75€
12074	150,152	11,50€	13005	336	1,25€	13064	339	2,60€	13122	340	1,95€
12075	150,152	15,50€	13006	336	1,40€	13065	339	2,00€	13123	340	5,35€
12200	208	14,50€	13007	336	1,30€	13066	339	2,25€	13124	340	8,20€
12889	270	12,00€	13008	336	2,25€	13067	339	2,55€	13125	340	5,95€
12901	185	5,20€	13009	336	1,65€	13068	338	2,85€	13126	340	1,55€
12902	309	4,50€	13010	336	1,75€	13069	338	4,55€	13127	340	5,60€
12908	309	4,50€	13011	336	1,15€	13070	338	2,15€	13128	337	1,85€
12910	309	4,40€	13012	336	1,80€	13071	338	2,05€	13129	337	2,00€
12915	309	12,40€	13013	336	1,75€	13072	338	2,75€	13130	337	3,75€
12920	309	7,80€	13014	336	1,45€	13073	338	2,10€	13131	337	3,45€
12923	309	9,50€	13015	336	1,20€	13074	339	4,65€	13132	337	2,65€
12924	309	4,10€	13016	336	1,15€	13075	339	5,35€	13133	337	3,45€
12925	309	10,70€	13017	336	2,60€	13076	339	3,90€	13134	337	3,95€
12926	200	21,50€	13018	336	1,45€	13077	339	2,55€	13135	337	3,45€
12927	200	21,50€	13019	336	1,75€	13078	339	2,55€	13136	337	2,60€
12928	200	22,00€	13020	336	1,70€	13079	339	3,35€	13137	337	2,25€
12929	200	23,00€	13021	336	1,30€	13080	338	1,75€	13138	337	2,85€
12930	200	23,50€	13022	336	2,10€	13081	338	2,30€	13139	337	3,85€
12931	153	7,50€	13023	336	1,50€	13082	338	1,35€	13140	337	2,65€
12932	153	7,50€	13024	336	2,45€	13083	338	1,50€	13141	337	1,80€
12933	153	8,00€	13025	336	1,50€	13084	338	2,10€	13142	337	3,10€
12934	153	7,50€	13026	341	1,55€	13085	338	1,60€	13143	337	1,95€
12935	153	8,00€	13027	341	1,85€	13086	338	1,25€	13144	337	2,20€
12936	153	8,50€	13028	341	1,45€	13087	338	3,30€	13145	337	3,85€
12937	150,152	9,50€	13029	341	1,65€	13088	338	2,40€	13146	337	4,50€
12938	153	10,00€	13030	341	2,80€	13089	338	1,70€	13147	337	3,10€
12939	153	10,00€	13031	341	1,85€	13090	338	1,70€	13148	337	3,30€
12940	153	10,00€	13032	341	2,00€	13091	338	1,25€	13149	337	3,10€
12941	153	10,00€	13033	341	1,60€	13092	340	1,65€	13150	337	2,25€
12942	153	10,00€	13034	341	2,65€	13093	340	2,95€	13151	337	5,35€
12943	153	10,00€	13035	341	1,65€	13094	340	1,50€	13152	337	3,05€
12944	153	10,00€	13036	341	1,40€	13095	340	1,20€	13153	337	3,10€
12945	153	10,50€	13037	341	2,10€	13096	340	1,70€	13154	337	3,20€
12950	354	3,45€	13038	338	1,40€	13097	340	1,20€	13155	337	5,60€
12952	354	1,92€	13039	338	1,65€	13098	340	1,65€	13156	337	3,30€
12954	335	0,25€	13040	338	1,80€	13099	340	2,75€	13157	337	3,85€
12955	160	27,80€	13041	338	1,55€	13100	340	1,20€	13158	337	3,75€
12956	160	45,00€	13042	338	1,95€	13101	340	1,50€	13159	337	3,20€
12957	160	27,80€	13043	338	1,20€	13102	340	1,60€	13160	337	5,00€
12958	160	27,80€	13044	338	1,55€	13103	340	1,80€	13161	337	3,55€
12959	160	27,80€	13045	338	1,20€	13104	336	1,90€	13162	337	2,60€
12960	160	27,80€	13046	338	1,55€	13105	336	2,50€	13163	337	2,80€
12961	160	27,80€	13047	338	1,45€	13106	336	2,00€	13217	354	1,31€
12973	310	1,00€	13048	338	2,20€	13107	336	2,15€	13226	49	4,50€

REF.	Pg.	PVP	REF.	Pg.	PVP	REF.	Pg.	PVP	REF.	Pg.	PVP
13227	49	4,50€	13497	35	7,50€	13817	138	17,00€	13961	330	9,25€
13228	49	4,50€	13498	35	8,50€	13818	138	20,50€	13962	330	1,76€
13229	49	4,50€	13499	139	12,50€	13822	329	11,00€	13963	330	12,40€
13230	49	4,50€	13500	139	12,90€	13823	329	6,00€	13964	330	15,00€
13231	49	4,50€	13667	49,79	17,60€	13824	329	8,00€	13965	330	1,50€
13232	49	4,50€	13668	79	18,70€	13825	329	11,50€	13966	330	12,90€
13234	255	224,50€	13669	57	18,00€	13826	329	13,00€	13967	330	4,65€
13235	327	0,15€	13672	267	220,00€	13827	329	15,00€	13968	349	1,35€
13236	327	0,15€	13674	50,327	0,50€	13828	329	11,50€	13969	181	19,00€
13237	327	0,15€	13675	50,327	0,50€	13829	329	10,50€	13982	252	4,00€
13238	327	0,20€	13676	50,327	0,50€	13830	329	10,50€	14004	153	9,50€
13239	327	0,20€	13677	50,327	0,50€	13831	329	12,60€	14005	153	10,50€
13240	327	0,40€	13678	50,327	0,50€	13832	329	13,00€	14006	153	9,50€
13241	327	0,55€	13680	152	15,50€	13833	329	9,00€	14007	153	9,50€
13243	349	12,50€	13681	152	15,50€	13836	260	9,00€	14008	153	9,50€
13244	349	12,50€	13682	152	15,50€	13839	120	8,50€	14009	153	9,50€
13245	349	12,50€	13683	152	15,50€	13842	160	8,50€	14010	153	11,00€
13447	36	16,50€	13684	152	15,50€	13843	160	7,00€	14011	153	11,00€
13448	36	17,50€	13685	152	15,50€	13844	160	9,00€	14013	138	3,50€
13449	36	20,00€	13686	152	15,50€	13845	160	8,00€	14014	253	6,00€
13450	36	23,00€	13687	152	15,50€	13853	260	122,00€	14015	253	6,00€
13451	36	28,00€	13688	152	15,50€	13856	180	7,80€	14016	253	6,00€
13452	36	29,50€	13689	152	15,50€	13859	154	16,00€	14026	54	5,50€
13453	34	9,00€	13704	204	21,00€	13870	265	82,00€	14027	54	5,60€
13454	34	9,50€	13707	61	14,00€	13874	154	17,50€	14028	54	7,00€
13455	34	10,50€	13708	61	14,00€	13875	154	18,50€	14029	54	8,50€
13456	34	11,50€	13709	61	14,00€	13876	154	18,50€	14030	54	9,50€
13457	34	12,00€	13710	61	14,00€	13877	154	18,50€	14031	115,120	7,90€
13460	34	15,00€	13712	61	14,00€	13879	314	1,38€	14032	120	12,00€
13462	34	17,00€	13717	354	7,65€	13880	314	1,50€	14033	120	4,50€
13463	35	5,30€	13723	155	18,50€	13923	79	7,45€	14034	353	9,00€
13464	35	5,30€	13724	155	19,20€	13929	346	3,45€	14049	63	8,00€
13465	35	5,55€	13725	155	19,20€	13930	148	1,50€	14050	63	10,50€
13466	35	5,55€	13726	155	19,00€	13931	148	2,50€	14051	63	18,00€
13467	35	6,00€	13727	155	18,70€	13932	148	2,50€	14052	63	19,50€
13468	35	6,25€	13728	155	18,50€	13933	148	2,00€	14059	73	62,00€
13469	35	6,25€	13729	155	22,00€	13934	148	2,50€	14060	73	65,00€
13470	35	6,60€	13730	155	22,00€	13935	148	2,50€	14061	73	93,00€
13471	35	6,90€	13731	155	21,60€	13936	148	3,50€	14062	73	100,00€
13472	35	7,25€	13732	155	21,60€	13937	148	4,00€	14063	73	119,00€
13473	35	8,10€	13733	155	24,90€	13938	148	3,50€	14064	73	39,50€
13474	35	8,70€	13734	155	25,70€	13939	148	4,00€	14068	260	13,00€
13475	35	9,10€	13735	155	25,80€	13945	330	7,40€	14069	260	13,00€
13476	35	9,60€	13736	155	25,90€	13946	330	6,70€	14070	260	116,00€
13477	35	9,85€	13738	314	3,50€	13947	330	5,85€	14071	260	21,50€
13478	35	12,20€	13739	314	5,50€	13948	330	5,00€	14072	260	21,50€
13479	35	13,10€	13740	314	5,50€	13949	330	6,50€	14073	260	128,00€
13480	35	15,50€	13741	313	21,00€	13950	330	7,80€	14075	148	2,00€
13481	35	15,80€	13745	155	25,20€	13951	330	5,15€	14076	148	1,50€
13482	35	22,10€	13746	155	25,40€	13952	330	10,90€	14077	148	4,50€
13483	35	25,50€	13747	155	25,40€	13953	330	8,00€	14078	148	4,00€
13484	35	27,20€	13748	155	24,90€	13954	330	12,70€	14081	276	12,60€
13491	35	5,30€	13805	310	10,50€	13955	330	4,95€	14083	354	13,20€
13492	35	5,35€	13806	310	10,50€	13956	330	4,30€	14090	267	103,00€
13493	35	5,50€	13809	148	18,50€	13957	330	9,70€	14103	164	32,40€
13494	35	6,00€	13810	148	20,50€	13958	330	5,45€	14104	164	32,40€
13495	35	6,40€	13813	163	7,00€	13959	330	10,10€	14105	164	32,40€
13496	35	6,60€	13814	163	11,00€	13960	330	9,65€	14106	164	32,40€

REF.	Pg.	PVP	REF.	Pg.	PVP	REF.	Pg.	PVP	REF.	Pg.	PVP
14107	164	32,40€	14192	148	4,00€	14365	344	1,90€	14432	342	1,45€
14108	164	32,40€	14193	148	4,00€	14366	344	1,45€	14434	342	1,60€
14109	276	29,00€	14195	147	4,00€	14367	344	1,30€	14435	342	1,45€
14110	276	110,00€	14196	147	4,00€	14368	344	1,45€	14436	342	1,70€
14114	79	19,30€	14197	147	4,50€	14369	344	4,95€	14437	342	1,45€
14118	302	26,00€	14198	147	4,00€	14370	344	3,00€	14438	342	1,35€
14120	132	22,00€	14199	147	4,00€	14371	344	3,00€	14439	342	1,75€
14121	132	26,00€	14200	147	4,50€	14372	344	1,20€	14440	342	1,75€
14122	133	34,00€	14201	147	4,00€	14373	344	1,35€	14441	342	1,65€
14123	133	33,00€	14202	147	4,00€	14374	344	1,70€	14442	342	1,45€
14124	135	20,50€	14203	147	4,50€	14375	344	1,85€	14443	342	1,45€
14125	135	19,50€	14204	147	1,50€	14376	344	2,60€	14444	342	1,90€
14126	136	54,00€	14205	147	1,50€	14377	344	1,90€	14445	342	1,45€
14127	135	32,50€	14206	147	1,50€	14378	344	1,90€	14446	342	2,80€
14128	136	13,50€	14207	147	1,50€	14379	344	1,45€	14447	341,342	1,45€
14129	135	12,50€	14208	147	1,50€	14380	352	51,00€	14448	342	2,05€
14130	134	21,00€	14209	147	1,50€	14381	344	1,70€	14449	341,342	2,20€
14131	134	24,00€	14211	192	11,00€	14382	344	1,85€	14450	342	2,15€
14132	135	21,50€	14212	192	12,00€	14383	344	1,35€	14451	342	2,15€
14133	136	16,50€	14213	192	12,00€	14384	344	2,10€	14452	342	2,55€
14134	136	17,50€	14214	192	14,00€	14387	343	1,45€	14453	342	3,05€
14135	137	12,50€	14286	139,161	2,99€	14388	343	2,05€	14455	342	2,10€
14136	138	12,00€	14287	139,161	2,99€	14389	343	1,25€	14456	342	1,35€
14137	138	131,00€	14288	139,161	6,00€	14390	343	1,35€	14457	342	1,70€
14141	73	105,00€	14289	139,161	6,10€	14391	343	2,15€	14458	341	1,70€
14142	73,175	109,00€	14291	269	87,00€	14392	343	1,35€	14459	341	1,45€
14143	73	124,00€	14296	66,67,68, 69,73,74,76	118,00€	14393	343	1,50€	14460	341	1,15€
14144	73	304,00€	14297	66,67,68, 69,74,76	87,00€	14395	343	1,65€	14461	341	1,35€
14145	272	8,50€	14298	66,67,68, 69,74,76	51,50€	14396	343	1,20€	14462	341	1,65€
14146	272	8,00€	14299	66,67,68, 69,74,76	87,00€	14397	343	1,45€	14463	341	1,65€
14147	272	25,00€	14300	207	19,00€	14398	343	1,30€	14464	341	1,50€
14148	272	25,00€	14301	207	19,00€	14399	343	1,90€	14465	341	2,00€
14153	134	20,50€	14314	147	5,00€	14402	343	1,50€	14466	341	1,65€
14154	139	42,00€	14315	147	4,50€	14404	343	2,10€	14468	341	1,30€
14157	138,210	8,30€	14330	139	3,50€	14405	343	1,45€	14469	341	1,45€
14158	138,210	9,95€	14336	134	58,00€	14406	343	1,55€	14471	341	1,90€
14159	138,210	12,60€	14340	191	10,50€	14408	343	1,45€	14472	341	1,35€
14160	138,210	12,80€	14341	191	10,50€	14409	343	1,35€	14473	251	46,00€
14161	138,210	13,70€	14342	191	10,50€	14410	343	1,85€	14474	341	1,50€
14162	139	25,50€	14343	191	10,50€	14411	343	1,70€	14475	341	1,65€
14163	139	25,50€	14344	191	11,00€	14412	343	1,70€	14476	341	2,05€
14164	139	25,50€	14345	191	11,00€	14413	343	3,25€	14477	341	2,45€
14165	132	26,50€	14346	191	11,00€	14414	343	1,70€	14478	341	4,05€
14167	62	2,50€	14347	348	36,50€	14415	343	1,70€	14479	341	1,65€
14168	145	7,00€	14348	186	12,50€	14416	343,344	1,25€	14480	341	2,05€
14169	147	3,00€	14349	186	20,50€	14419	343	1,95€	14481	341	1,70€
14172	151	8,50€	14350	343,344	1,80€	14420	343	1,50€	14507	354	50,00€
14173	151	9,50€	14351	344	1,65€	14421	343	2,45€	14534	144	16,50€
14177	151	9,50€	14352	344	1,30€	14422	342	1,50€	14560	144	8,80€
14178	151	9,50€	14353	344	2,10€	14423	342	3,55€	14561	144	8,80€
14179	60	8,50€	14354	80	14,00€	14424	342	1,85€	14563	209	18,00€
14180	60	7,90€	14355	344	1,70€	14425	342	2,05€	14564	161	9,20€
14183	44	31,00€	14356	344	1,90€	14426	342	1,90€	14565	161	26,70€
14187	208	6,00€	14357	344	1,90€	14427	342	1,20€	14566	161	16,70€
14188	141	0,50€	14358	343,344	1,70€	14428	342	1,40€	14567	161	38,00€
14189	354	52,00€	14359	341,344	1,05€	14429	342	1,80€	14568	161	9,20€
14190	148	2,00€	14364	344	1,90€	14430	342	2,25€	14569	161	9,20€
14191	148	2,00€				14431	342	1,45€	14570	161	4,05€

REF.	Pg.	PVP	REF.	Pg.	PVP	REF.	Pg.	PVP	REF.	Pg.	PVP
14571	161	9,20€	14660	94	83,00€	14733	150,155	4,30€	14838	93,109	3,40€
14573	161	4,05€	14661	94	9,00€	14734	150,155	5,40€	14839	93,109	4,70€
14578	80	12,50€	14662	94	2,50€	14735	150	6,50€	14840	93,109	3,35€
14580	80	41,00€	14663	94	2,50€	14736	151,155	5,00€	14841	93,109	2,58€
14583	132	6,00€	14664	95	100,00€	14737	151,155	5,00€	14842	93,109	9,50€
14589	267	2,50€	14665	95	8,80€	14738	155	5,50€	14843	110	0,50€
14594	207,331	2,00€	14666	95	97,00€	14739	155	5,50€	14844	110	0,50€
14595	207,331	1,50€	14667	95	8,80€	14740	155	5,55€	14845	110	0,50€
14596	207,331	2,00€	14668	95	7,70€	14741	155	5,55€	14846	110	0,50€
14597	207,331	7,60€	14670	95	4,50€	14742	155	5,55€	14847	110	0,50€
14598	207,331	17,80€	14671	96	44,00€	14743	155	5,15€	14848	110	0,50€
14599	207,331	4,50€	14672	96	5,00€	14744	155	5,35€	14849	110	1,00€
14600	207,331	9,50€	14674	96	73,00€	14745	155	6,25€	14850	110	1,00€
14601	207,331	11,00€	14675	88,90	17,00€	14746	155	6,40€	14851	110	1,00€
14602	207,331	11,00€	14676	88,90	36,50€	14747	155	7,10€	14852	110	1,00€
14611	197	12,00€	14677	88,90	9,00€	14748	155	8,30€	14853	110	1,00€
14612	197	11,00€	14678	88,90	86,00€	14749	28,154	2,00€	14854	110	1,00€
14613	197	13,50€	14679	88,90	9,50€	14750	28,154	2,00€	14855	110	1,00€
14615	261	9,50€	14680	95	17,00€	14751	28,154	4,00€	14856	110	1,00€
14616	266	96,00€	14681	95	108,00€	14752	28,154	4,00€	14857	110	1,50€
14618	133	19,00€	14682	95	9,00€	14753	129	13,00€	14858	110	1,50€
14622	107,353	17,00€	14683	95	86,00€	14755	272	134,00€	14859	110	1,50€
14623	107,353	8,00€	14684	94	3,00€	14756	272	15,20€	14860	110	2,00€
14624	107,353	17,00€	14685	94	5,00€	14757	272	15,20€	14861	110	2,00€
14625	107,353	14,00€	14686	94	73,00€	14758	272	18,00€	14862	110	2,00€
14626	107,353	7,00€	14687	94	35,00€	14759	272	18,00€	14863	110	2,50€
14628	101	2,50€	14691	97	167,00€	14765	91	97,00€	14864	110	2,50€
14629	101	4,00€	14692	97	5,50€	14766	92	3,15€	14865	110	2,50€
14630	101	22,00€	14693	93	3,50€	14767	92	2,34€	14866	110	3,00€
14631	101	3,50€	14694	93	11,50€	14768	95	28,80€	14867	110	3,00€
14632	101	3,50€	14695	93	4,00€	14769	88,90	37,75€	14868	110	0,55€
14633	132	22,50€	14696	93	18,00€	14770	95	40,00€	14869	110	0,60€
14634	101	36,50€	14697	93	8,00€	14771	146,283	10,50€	14870	110	1,00€
14635	101	10,00€	14698	93	1,00€	14772	146	8,50€	14871	110	1,00€
14636	102	30,00€	14699	93	30,00€	14774	283	10,50€	14872	110	1,00€
14637	91	15,50€	14700	93	2,50€	14775	322	30,50€	14873	110	1,00€
14638	91	7,00€	14701	93	2,50€	14779	135	33,00€	14874	110	1,00€
14639	266	195,00€	14702	93	92,00€	14781	319	9,90€	14875	110	1,50€
14640	91	8,00€	14703	251	13,00€	14783	80	5,50€	14876	110	1,50€
14641	91	18,50€	14706	269	8,90€	14785	270	3,50€	14877	110	1,50€
14642	91	83,00€	14708	261	59,00€	14793	319	12,00€	14878	110	2,00€
14643	92	24,50€	14709	260	122,00€	14802	322	44,00€	14879	110	2,00€
14644	92	8,00€	14710	161	3,50€	14803	322	43,00€	14880	110	2,50€
14645	92	45,00€	14711	161	3,75€	14807	354	11,00€	14881	110	2,50€
14646	92	110,00€	14712	161	4,00€	14808	92	3,05€	14882	110	3,00€
14647	96	3,00€	14713	161	4,25€	14825	109	1,50€	14883	110	3,50€
14648	88,90	106,00€	14714	161	4,50€	14826	109	1,50€	14884	110	3,65€
14649	96	50,00€	14715	161	4,75€	14827	109	2,00€	14885	110	4,00€
14650	96	5,00€	14723	154	18,00€	14828	109	1,50€	14886	110	4,60€
14651	96	86,00€	14724	154	18,50€	14829	109	1,50€	14887	110	5,00€
14652	92	47,00€	14725	154	18,50€	14830	109	1,50€	14888	110	6,00€
14653	92	5,25€	14726	154	17,50€	14831	109	1,50€	14889	110	6,50€
14654	92	104,00€	14727	269	108,00€	14832	109	2,00€	14890	110	7,00€
14655	92	5,95€	14728	150,155	3,80€	14833	109	2,05€	14891	110	7,50€
14656	92	4,50€	14729	150,155	3,80€	14834	109	2,50€	14892	110	8,00€
14657	92	4,50€	14730	150,155	3,80€	14835	109	3,00€	14893	92,112	2,00€
14658	94	45,00€	14731	150,155	3,80€	14836	109	3,50€	14894	112	1,20€
14659	94	5,00€	14732	150,155	3,80€	14837	93,109	3,30€	14895	112	1,90€

REF.	Pg.	PVP	REF.	Pg.	PVP	REF.	Pg.	PVP	REF.	Pg.	PVP
14896	112	2,10€	14962	96	6,50€	15051	354	1,92€	15144	82	30,00€
14897	112	0,88€	14963	96	7,50€	15052	208	3,00€	15145	82	20,45€
14898	112	0,98€	14964	94	8,00€	15053	208	10,50€	15146	82	16,20€
14899	112	0,88€	14965	94	8,50€	15054	208	34,00€	15147	53	5,00€
14900	92,112	0,98€	14966	97	7,50€	15056	354	11,70€	15148	53	5,00€
14901	111	3,60€	14967	93	5,50€	15058	80	7,50€	15149	53	5,00€
14902	111	4,65€	14968	93	6,00€	15059	319	10,00€	15151	101	10,50€
14903	111	5,25€	14970	150	2,50€	15062	319	1,00€	15152	348	160,00€
14904	111	6,85€	14971	150	2,50€	15065	80	6,50€	15153	292	2,50€
14905	111	8,50€	14972	150	3,50€	15068	80	15,20€	15154	292	7,50€
14906	111	10,20€	14973	150	11,50€	15069	80	32,80€	15155	67,77	59,00€
14907	109	0,50€	14974	354	2,28€	15070	75	0,50€	15156	39,77	70,00€
14908	109	0,60€	14975	351	64,00€	15071	74	0,60€	15157	77	42,00€
14909	109	0,80€	14976	354	18,84€	15072	74	0,70€	15158	77	59,00€
14910	109	1,00€	14978	54	7,50€	15073	74	1,00€	15159	77	44,00€
14911	109	1,30€	14979	54	9,00€	15074	74	1,00€	15160	77	42,00€
14912	109	1,55€	14980	54	13,00€	15075	74	1,20€	15161	67,77	62,00€
14913	109	1,90€	14981	54	22,50€	15076	74	3,50€	15162	32,78,289	30,20€
14914	109	2,10€	14982	54	27,50€	15083	75	8,50€	15206	39	15,00€
14915	109	2,65€	14985	96,112	6,00€	15084	75,181	68,00€	15207	39	16,50€
14916	109	2,95€	14986	96,112	4,00€	15085	270	156,00€	15208	39	17,00€
14917	109	3,45€	14987	97,112	8,50€	15093	262	38,00€	15209	39	18,00€
14918	301,320	0,23€	14988	96,112	8,00€	15094	262	39,50€	15227	32	3,50€
14919	301,320	0,45€	14989	96,112	6,00€	15095	262	13,00€	15228	32	4,00€
14920	109	2,50€	14990	97,112	10,50€	15096	262	40,00€	15229	32	5,00€
14922	354	0,84€	14991	95,112	2,00€	15098	104	11,50€	15230	32	5,00€
14923	354	0,84€	14992	178	8,50€	15099	104	5,50€	15231	32	3,50€
14924	354	0,84€	14993	95,112	5,00€	15100	104	70,00€	15232	32	4,00€
14925	354	0,84€	14994	95,112	3,50€	15101	104	11,00€	15233	32	5,00€
14926	354	1,05€	14995	95,112	8,00€	15102	104	40,00€	15234	32	3,00€
14929	264	35,00€	14996	352	65,00€	15103	104	20,50€	15237	277	12,00€
14930	182	9,50€	15001	344	3,00€	15104	104	31,50€	15238	277	5,00€
14931	182	8,00€	15010	214	16,50€	15105	104	30,00€	15239	277	5,50€
14932	182	9,50€	15011	214	18,00€	15106	104	15,00€	15240	277	9,50€
14933	182	9,50€	15012	214	31,50€	15107	105	4,00€	15241	277	65,00€
14934	111	4,25€	15014	92,112	20,00€	15108	105	2,16€	15242	277	2,50€
14935	111	8,45€	15018	75,253	46,00€	15109	105	25,50€	15243	277	4,00€
14936	94	27,50€	15023	80	12,50€	15110	105	6,55€	15244	277	2,00€
14937	253	9,50€	15024	80	15,00€	15111	105	30,40€	15245	277	7,50€
14938	270	42,00€	15025	80	12,50€	15112	105	3,25€	15246	277	108,00€
14939	270	57,00€	15026	80	15,00€	15113	105	11,80€	15247	277	2,50€
14940	270	248,00€	15030	80	8,00€	15114	104	6,00€	15248	277	2,50€
14945	352	303,50€	15033	80	6,00€	15115	104	8,50€	15249	277	5,00€
14946	352	58,00€	15034	80	57,00€	15116	104	29,50€	15250	277	4,50€
14947	352	201,50€	15035	80	8,50€	15117	104	29,50€	15251	277	15,00€
14948	352	251,50€	15036	80	8,50€	15118	104	52,00€	15253	196,202	62,00€
14950	101	6,50€	15037	80	8,00€	15119	104	10,00€	15254	91	12,50€
14951	101	9,50€	15038	80	34,50€	15120	104	6,50€	15255	265	114,00€
14952	101	19,00€	15040	80	12,50€	15121	104	12,00€	15256	348	36,00€
14953	101	8,50€	15041	80	15,00€	15122	35,67,77	74,00€	15257	348	27,50€
14954	92	14,50€	15042	80	7,50€	15123	251	32,00€	15258	348	27,50€
14955	96	7,50€	15043	266	195,00€	15124	102	9,50€	15259	348	18,00€
14956	92	4,40€	15044	266	259,00€	15125	102	23,00€	15260	348	22,50€
14957	92	4,10€	15046	266	47,00€	15126	99	19,50€	15276	98	46,00€
14958	94	22,00€	15047	266	47,00€	15127	99	29,00€	15277	98	9,00€
14959	94	10,00€	15048	266	5,00€	15138	51	10,50€	15278	98	3,50€
14960	95	3,85€	15049	102	37,40€	15139	51	12,00€	15279	98	69,00€
14961	95	3,95€	15050	80	9,50€	15140	51	13,50€	15280	98	91,00€

REF.	Pg.	PVP	REF.	Pg.	PVP	REF.	Pg.	PVP	REF.	Pg.	PVP
15282	253	15,00€	15398	282	75,00€	15500	178	10,00€	15732	70,76	293,50€
15283	253	27,50€	15399	282	117,00€	15501	178	10,00€	15733	70,76	113,00€
15300	309	5,00€	15424	106,281	105,00€	15502	178	10,00€	15734	70,76	288,50€
15305	253	19,50€	15425	106,281	50,00€	15503	178	11,00€	15735	76	38,00€
15306	253	27,50€	15426	106,281	10,00€	15504	178	10,00€	15736	76	488,50€
15307	253	39,60€	15427	106,281	9,00€	15505	178	4,00€	15737	48,78	45,00€
15308	253	7,00€	15428	106,281	238,00€	15506	178	4,00€	15765	101	14,00€
15309	253	17,00€	15429	106,281	23,50€	15507	178	4,50€	15781	272	19,84€
15310	253	11,50€	15430	106,281	83,00€	15508	178	4,50€	15782	272	16,00€
15311	253	11,50€	15431	106,281	241,00€	15509	178	5,00€	15789	350	2.545,00€
15312	253	11,50€	15432	106,281	18,50€	15510	178	5,00€	15799	46,79	28,30€
15313	80	14,00€	15433	106,281	197,00€	15511	178	8,00€	15866	293	32,00€
15315	78	28,20€	15434	106,281	147,00€	15514	67,78	9,35€	15874	249	6,50€
15316	36,77	58,00€	15435	106,281	24,50€	15515	36	15,50€	15905	296	16,50€
15317	309	4,50€	15436	106,281	97,00€	15516	36	19,00€	15906	296	28,50€
15318	253	17,00€	15437	106,281	305,50€	15517	36	22,50€	15907	296	12,00€
15320	98	1,00€	15438	106,281	31,00€	15526	264	48,00€	15908	296	14,50€
15321	98	3,00€	15439	106,281	52,00€	15527	264	276,00€	15909	296	21,50€
15322	98	3,50€	15440	99	33,00€	15528	264	39,00€	15910	296	16,50€
15323	98	24,00€	15454	58,77	35,40€	15530	93	7,50€	15911	296	30,50€
15324	98	18,00€	15460	287	5,00€	15531	93	5,00€	15912	296	35,50€
15325	98	3,50€	15462	105	7,50€	15532	93	98,00€	15913	296	7,50€
15326	98	1,00€	15463	105	114,00€	15533	93	4,50€	15914	296	7,50€
15327	98	5,50€	15464	105	6,50€	15534	93	4,50€	15980	250	55,00€
15328	35	6,00€	15465	105	11,50€	15535	93	3,50€	15981	250	181,00€
15329	35	5,50€	15466	105	6,50€	15536	93	14,50€	15982	250	73,00€
15330	35	5,50€	15467	105	14,00€	15537	93	6,00€	15983	250	11,50€
15331	35	5,50€	15468	105	2,50€	15538	93	17,00€	15984	250	48,00€
15332	35	6,00€	15469	105	9,50€	15539	255	104,00€	16020	37	17,00€
15333	35	6,50€	15470	105	7,50€	15541	77	27,60€	16021	37	19,50€
15334	35	7,00€	15471	105	20,10€	15542	255	45,00€	16022	37	23,00€
15335	35	7,50€	15472	105	19,00€	15550	253	6,00€	16023	37	26,50€
15336	35	8,00€	15473	105	13,70€	15551	253	6,00€	16024	37	34,50€
15337	35	8,50€	15474	105	8,50€	15552	172	181,00€	16025	37	37,50€
15338	35	9,00€	15475	105	8,50€	15553	250	108,00€	16052	120,123	2,09€
15339	35	9,50€	15476	105	11,00€	15564	133	11,90€	16053	120,123	2,85€
15340	349	5,50€	15477	105	5,70€	15631	251	98,00€	16111	79	19,20€
15341	349	5,50€	15478	105	3,60€	15632	34	9,35€	16130	287	290,00€
15342	349	9,00€	15480	255	0,99€	15633	34	9,50€	16138	106	7,45€
15343	349	9,50€	15481	103	4,50€	15634	34	10,60	16139	106	14,20€
15344	349	6,50€	15482	103	4,00€	15635	34	11,00€	16140	106	14,20€
15345	349	10,50€	15483	103	4,00€	15636	34	12,30€	16141	106	4,45€
15346	349	24,00€	15484	103	5,50€	15637	34	12,50€	16142	106	10,80€
15349	349	8,50€	15485	103	4,00€	15681	55,78	134,00€	16143	106	2,06€
15375	161	28,00€	15486	103	9,00€	15671	297	20,50€	16144	106	12,80€
15380	99	169,00€	15487	103	59,00€	15706	55,78	31,00€	16145	106	79,00€
15381	99	5,50€	15488	103	4,00€	15708	58	10,00€	16146	106	4,45€
15382	99	42,00€	15489	103	10,50€	15710	58	10,00€	16147	106	13,00€
15385	122	18,00€	15490	103	4,00€	15719	100	11,00€	16148	106	35,40€
15388	282	33,00€	15491	103	4,00€	15720	100	59,00€	16149	106	38,60€
15389	282	18,50€	15492	103	5,00€	15721	100	46,00€	16150	100	7,90€
15390	282	43,00€	15493	103	4,50€	15722	100	4,25€	16151	89	50,00€
15391	282	13,50€	15494	178	12,50€	15723	100	2,21€	16152	89	25,10€
15392	282	17,50€	15495	178	12,50€	15724	100	2,82€	16153	89	81,00€
15393	282	12,50€	15496	178	11,50€	15725	100	1,86€	16154	89	34,10€
15394	282	26,00€	15497	178	11,00€	15726	100	2,82€	16155	89	34,10€
15395	282	3,50€	15498	178	11,50€	15730	70,76	289,00€	16156	89	12,60€
15396	300	2,04€	15499	178	11,00€	15731	70,76	214,00€	16157	89	59,00€

REF.	Pg.	PVP	REF.	Pg.	PVP	REF.	Pg.	PVP	REF.	Pg.	PVP
16158	128	9,00€	50765	308	0,58€	50935	252	595,00€	51259	193	58,00€
16160	106	3,99€	50766	308	0,68€	50937	204	10,50€	51260	25	37,00€
16161	80	17,50€	50767	308	0,78€	50942	274,288	28,00€	51261	25	36,00€
16162	80	35,10€	50768	308	0,88€	50957	295	22,00€	51262	203	51,00€
16163	80	10,20€	50771	308	0,29€	50959	295,328	12,00€	51262R	203	14,00€
16165	280	2,00€	50774	308	0,57€	50960	295	18,30€	51266	301	28,00€
16166	280	23,50€	50776	308	0,76€	50966	300,317	4,00€	51272	55	7,50€
16167	280	7,00€	50778	308	0,10€	50980	30	22,00€	51277	144	64,00€
16168	280	5,00€	50779	308	0,19€	50982	30	22,00€	51283	174	78,00€
16169	280	1,50€	50780	308	0,29€	50983	27	48,00€	51305	52	28,90€
16170	280	1,50€	50781	308	0,38€	50985	27	59,00€	51306	52	28,10€
16171	280	20,50€	50782	308	0,49€	51017	58	6,80€	51307	52	29,70€
16172	280	22,50€	50783	314	0,58€	51018	58	7,05€	51315	353	2,50€
16173	280	3,00€	50784	308	0,68€	51020	58	6,65€	51318	34	98,00€
16188	80	39,60€	50785	308	0,78€	51021	58	7,05€	51326	119	4,40€
16198	287	5,00€	50786	308	0,88€	51028	154	163,00€	51332	178	98,00€
54294	317	8,80€	50787	214	8,00€	51033	283	98,00€	51333	28	18,00€
50400	169	168,00€	50788	214	14,50€	51035	82	799,00€	51336	151	29,30€
50403	169	98,00€	50789	214	29,00€	51050	295	285,00€	51337	182	50,00€
50409	170	26,00€	50790	214	29,00€	51051	295	34,80€	51338	203	53,00€
50410	169	168,00€	50792	188	105,00€	51055	308	0,98€	51338R	203	14,00€
50431	129	3,80€	50793	188	94,00€	51056	308	0,75€	51340	245	39,30€
50517	293	129,00€	50797	256,292	490,00€	51059	175	99,00€	51341	142,214	35,00€
50518	293	169,00€	50807	207,332	38,00€	51119	187	62,00€	51347	212	9,90€
50523	129	4,70€	50808	85	77,00€	51120	210	41,00€	51349	200	37,30€
50524	129	4,70€	50815	261	88,00€	51121	211	27,30€	51352	179	9,80€
50525	300	1,00€	50816	261	88,00€	51123	196	91,00€	51353	179	11,50€
50526	300	4,80€	50818	261	198,00€	51124	197	88,00€	51354	180	13,20€
50551	130	350,00€	50819	262	28,00€	51125	196	88,00€	51355	62,310	19,00€
50560	37	38,60€	50820	262	34,50€	51126	198	18,00€	51356	258	48,00€
50561	38	19,20€	50821	262	47,00€	51127	203	56,00€	51358	312	7,50€
50562	39	23,50€	50822	262	59,00€	51127R	203	14,00€	51359	312	9,00€
50564	38	30,00€	50823	262	94,00€	51131	161	61,00€	51360	162	8,05€
50567	58	9,60€	50824	262	88,00€	51140	201,237	64,00€	51361	162	9,80€
50577	164	12,60€	50825	262	154,00€	51206	132	228,00€	51362	312	3,00€
50585	306	14,70€	50827	211,267	387,00€	51207	132	289,00€	51363	272	114,00€
50600	308	0,60€	50830	264	560,00€	51210	133	650,00€	51364	201	26,00€
50601	308	0,29€	50831	267	460,00€	51211	133	560,00€	51365	272	118,00€
50622	36	64,00€	50835	265	290,00€	51212	133	488,00€	51368	194	19,00€
50623	24	60,00€	50836	268	148,00€	51213	133	690,00€	51369	194	28,00€
50630	269	590,00€	50838	268	299,00€	51214	135	148,00€	51383	144	11,10€
50631	267	68,00€	50839	270	180,00€	51215	135	119,00€	51384	25	34,00€
50632	279	298,00€	50840	268	138,00€	51216	136	650,00€	51385	142	4,55€
50644	301	11,60€	50843	85	79,00€	51218	135	288,00€	51386	142	5,95€
50651	332	16,50€	50844	85	65,00€	51219	136	222,00€	51387	142	3,25€
50652	332	16,50€	50852	257	24,50€	51220	135	240,00€	51388	136	22,00€
50654	300,317	4,00€	50901	162	16,00€	51221	134	199,00€	51389	136	22,00€
50656	172	290,00€	50902	42	13,00€	51222	134	128,00€	51390	136	22,00€
50717	301	21,90€	50903	162	30,80€	51225	135	198,00€	51391	136	22,00€
50724	204	28,00€	50910	128	45,00€	51226	136	233,00€	51392	136	34,00€
50731	254	68,00€	50911	269	788,00€	51227	136	193,00€	51393	136	34,00€
50751	143,257	43,00€	50913	172	195,00€	51235	273	49,00€	51398N	316	1,74€
50754	36	98,00€	50915	129	4,20€	51238	272	138,00€	51400	182	17,00€
50760	308	0,10€	50916	170	0,88€	51239	272	159,00€	51401	182	22,00€
50761	308	0,19€	50917	252	271,00€	51245	137	99,00€	51402	182	20,50€
50762	308	0,29€	50918	252	341,00€	51246	303,318	6,40€	51403	182	17,50€
50763	308	0,38€	50923	167,270	454,00€	51253	252	41,00€	51405	52	21,10€
50764	308	0,49€	50924	249	342,00€	51258	119	0,15€	51406	52	29,20€

REF.	Pg.	PVP	REF.	Pg.	PVP	REF.	Pg.	PVP	REF.	Pg.	PVP
51409	25	36,00€	51656	81	3,65€	51816	273	49,00€	51967	125	16,00€
51410	25	36,00€	51657	81	5,85€	51817	300,317	4,50€	51968	125	16,00€
51412	303	2,10€	51658	81	4,50€	51818	19	95,00€	51969	124	14,00€
51414	194	14,00€	51659	36	59,00€	51819	16	48,00€	51972	57	12,00€
51416	311	12,00€	51661	53,311	12,00€	51824	170	36,80€	51973	305	45,00€
51419	81	2,79€	51674	46	7,75€	51830	204	94,00€	51975	81	2,27€
51422	81	2,97€	51680	298	2,40€	51831	276	24,00€	51976	81	1,63€
51439	136	26,00€	51681	298	4,50€	51832	162	18,00€	51978	169	84,00€
51440	136	28,00€	51691	298	2,40€	51837	280	195,00€	51980	143	15,00€
51441	136	26,00€	51692	298	3,25€	51838	280	667,00€	51981	143	21,50€
51442	136	28,00€	51693	298	3,55€	51839	176,275	24,00€	51982	293	120,00€
51443	142	5,50€	51694	298	3,55€	51842	273	6,90€	51983	293	180,00€
51444	142	5,05€	51696	298	3,55€	51843	330	0,19€	51984	293	190,00€
51445	142	5,05€	51697	300	0,80€	51853	47	18,00€	51985	170	84,00€
51447	54,80	16,00€	51703	314	10,50€	51855	23	378,00€	51986	215	11,90€
51448	54,80	52,00€	51705	314	8,45€	51858	305	15,00€	51989	216	49,00€
51452	268	69,00€	51706	313	22,80€	51859	276	3,80€	51991	195	48,00€
51456	81	550,00€	51707	313	9,05€	51861	136,314	199,00€	51995	60,61	24,50€
51479	55	31,80€	51708	313	14,20€	51863	305	54,00€	51998	190	38,00€
51488	245	16,00€	51709	313	14,70€	51864	40,78	64,00€	52009	32,289	36,00€
51489	245	12,00€	51710	313	17,80€	51886	128	44,00€	52010	198	80,00€
51490	196	36,00€	51711	313	21,20€	51889	115	49,00€	52012	205	68,00€
51491	186	154,00€	51712	313	8,65€	51890	41	92,00€	52016	187	2,10€
51493	185	68,00€	51713	313	13,10€	51893	189	690,00€	52017	187	2,40€
51494	183	107,00€	51714	313	15,80€	51895	261	99,00€	52018	187	2,60€
51495	191	59,00€	51715	313	20,30€	51896	187	82,00€	52019	187	3,20€
51496	192	8,00€	51716	313	23,60€	51897	187	122,00€	52021	187	3,40€
51500	194	29,00€	51717	313	11,20€	51898	187	139,00€	52022	187	4,50€
51501	195	38,00€	51718	313	14,80€	51899	187	137,00€	52023	187	6,60€
51504	46	8,50€	51719	313	22,00€	51901	265	999,00€	52024	187	10,60€
51525	55	9,80€	51720	313	23,50€	51902	195	84,00€	52025	187	13,00€
51526	55	9,80€	51721	313	25,00€	51905	262	34,50€	52026	162	31,80€
51528	40	49,00€	51722	313	13,10€	51906	262	39,00€	52027	324	14,00€
51529	38	59,00€	51723	313	18,70€	51907	262	48,00€	52028	326	15,20€
51546	330	0,19€	51724	313	24,40€	51908	309	44,00€	52029	326	14,00€
51554	330	0,28€	51725	313	28,30€	51909	44	2,46€	52030	329	98,00€
51573	119,302	2,50€	51726	313	31,40€	51918	46	12,50€	52031	328	44,00€
51574	84	52,00€	51727	313	49,00€	51919	205	89,00€	52032	329	28,00€
51575	84	317,00€	51737	82	699,00€	51920	215,332	18,00€	52033	333	43,00€
51576	81	125,00€	51738	82	850,00€	51923	179	12,50€	52043	327	16,50€
51600	84	109,00€	51741	311	0,50€	51925	300	1,00€	52044	325	19,00€
51604	308	0,98€	51742	311	0,50€	51927	246	25,00€	52047	129	3,30€
51612	129	5,95€	51743	311	0,55€	51928	256	14,00€	52048	129	3,95€
51613	129	2,90€	51745	316	0,70€	51929	129	22,00€	52049	48	14,00€
51614	129	3,60€	51746	30	12,00€	51930	24	39,00€	52050	61	98,00€
51615	129	5,95€	51750	269	299,00€	51934	179	11,50€	52052	58	53,00€
51616	23	378,00€	51751	270	99,00€	51935	302	135,00€	52053	335	45,00€
51622	171	25,30€	51785	316	0,75€	51936	302	135,00€	52054	335	17,00€
51632N	316	1,74€	51795	63	9,00€	51937	302	135,00€	52055	268	129,00€
51633	316	1,74€	51796	63	14,00€	51951	47	15,60€	52056	205	66,00€
51634	316	1,74€	51797	63	18,00€	51958	204	422,00€	52057	170	6,80€
51636N	316	1,54€	51798	63	39,60€	51960	124	34,00€	52058	170	4,50€
51638N	316	1,54€	51799	330	0,20€	51961	124	34,00€	52059	30	29,00€
51640N	316	1,54€	51801	53	62,00€	51962	123	25,00€	52060	30	32,00€
51642N	316	1,54€	51804	328	58,00€	51963	123	29,00€	52065	170	45,00€
51653	81	5,10€	51805	54,80	17,00€	51964	123	28,00€	52066	213	12,00€
51654	81	4,80€	51812	59	46,00€	51965	123	29,50€	52069	272	29,50€
51655	81	4,10€	51814	300	8,00€	51966	124	18,00€	52070	272	40,00€

REF.	Pg.	PVP	REF.	Pg.	PVP	REF.	Pg.	PVP	REF.	Pg.	PVP
52071	272	47,00€	52270	199	109,00€	52368	130	1,14€	52478	165	49,00€
52076	190	111,00€	52271	245	18,00€	52369	130	1,19€	52479	165	24,70€
52077	163	29,50€	52272	59	24,60€	52370	130	1,17€	52480	165	44,00€
52148	85	82,00€	52273	185	44,00€	52373	81	252,00€	52481	165	52,00€
52149	293	230,00€	52275	176	38,00€	52375	123	38,00€	52482	165	44,00€
52152	57	13,50€	52293	193	98,00€	52378	142,214	10,00€	52483	165	41,00€
52153	190	46,00€	52295	166	6,50€	52381	144	20,50€	52484	165	66,00€
52156	140	140,00€	52296	198	119,00€	52382	274,288	19,50€	52485	165	51,00€
52157	141	48,00€	52297	198	172,00€	52384	117	29,00€	52486	165	62,00€
52158	328	38,50€	52298	198	177,00€	52385	164	251,00€	52487	165	63,00€
52159	141	64,00€	52302	125	25,40€	52386	164	23,60€	52488	188	28,00€
52160	141	48,00€	52303	126	26,40€	52387	164	24,50€	52489	189	58,00€
52162	71,275,290	38,00€	52304	262	84,00€	52390	165	35,20€	52490	144	6,65€
52163	330	95,00€	52305	190	106,00€	52391	258	5,00€	52491	144	10,50€
52165	140	118,00€	52308	86	440,00€	52393	74	1.180,00€	52493	300,320	4,50€
52167	140	48,00€	52309	86	941,00€	52412	59	5,00€	52494	200	227,00€
52169	43	25,00€	52310	316	3,65€	52414	126	19,00€	52495	206	14,50€
52170	43	16,00€	52311	179	19,00€	52415	126	19,00€	52497	213	26,80€
52171	141	39,00€	52312	179	9,00€	52416	180	14,00€	52498	256	58,00€
52172	74	780,00€	52313	179	8,00€	52417	180	28,00€	52500	42	19,00€
52180	46	19,00€	52314	179	26,60€	52418	23	164,00€	52502	165	31,40€
52181	46	22,50€	52315	176	16,00€	52419	81	80,00€	52503	165	32,50€
52182	46	24,00€	52316	192	18,90€	52420	81	108,00€	52504	165	27,60€
52183	46	26,20€	52317	192	19,90€	52421	81	172,00€	52505	164	20,80€
52184	46	43,00€	52318	194	73,00€	52422	160	24,70€	52506	164	16,00€
52185	46	55,00€	52319	215	8,80€	52424	63	64,00€	52507	165	30,10€
52186	46	72,00€	52320	30	22,00€	52425	46	33,30€	52508	61	38,40€
52187	305	21,80€	52321	167	8,80€	52426	46	52,00€	52509	61	36,20€
52188	47	15,50€	52327	167	12,00€	52427	46	64,00€	52511	165	42,00€
52190	194	8,00€	52328	176	99,00€	52428	252	43,00€	52512	164	50,00€
52191	176	198,00€	52329	252	36,40€	52430	318	10,90€	52514	270	84,00€
52195	279	170,00€	52330	174	99,00€	52432	199	35,00€	52515	62,216	9,10€
52197	52	36,30€	52331	140	201,00€	52433	204	4,80€	52516	214	28,00€
52198	29	37,70€	52337	150	65,00€	52434	176	125,00€	52517	214	6,00€
52200	294	88,00€	52338	151	41,00€	52436	276	680,00€	52518	179	115,00€
52201	294	66,00€	52339	153	61,00€	52439	274	227,00€	52519	32,289	25,50€
52202	294	88,00€	52340	153	58,00€	52450	275	105,00€	52521	32,289	125,00€
52207	51	24,20€	52341	150	58,00€	52451	39	42,00€	52524	54	51,00€
52227	211	247,00€	52342	151	63,00€	52452	249	8,00€	52525	54	13,80€
52230	172	398,00€	52343	152	52,00€	52453	249	21,00€	52526	54	28,40€
52231	275	49,00€	52344	153	197,00€	52454	202	12,90€	52527	141	82,00€
52233	273	328,00€	52345	150	109,00€	52455	176	16,00€	52528	137	49,00€
52235	64	11,00€	52346	150	103,00€	52456	123	36,00€	52530	306	14,00€
52236	64	13,30€	52347	154	158,00€	52458	128	58,00€	52533	166	10,00€
52237	64	18,10€	52348	154	179,00€	52460	47	16,60€	52534	306	15,00€
52238	64	24,90€	52349	64	22,10€	52461	47	25,70€	52535	306	16,50€
52241	265	1.690,00€	52350	64	22,60€	52462	49	25,30€	52536	114	57,00€
52242	258	12,00€	52351	64	25,40€	52463	49	26,10€	52538	28	62,00€
52243	258	8,50€	52352	64	32,40€	52464	49	42,00€	52539	28	59,00€
52244	169	84,00€	52353	64	33,40€	52466	214	11,00€	52540	171	221,00€
52251	305	21,80€	52354	64	34,40€	52467	214	10,30€	52541	196	45,00€
52254	120	64,00€	52355	64	36,60€	52468	55	5,90€	52542	85	109,00€
52259	300	3,75€	52357	64	54,00€	52472	55	4,90€	52543	143	182,00€
52262	166	7,50€	52358	64	63,00€	52473	55	9,90€	52544	154	93,00€
52263	166	13,50€	52362	130	1,23€	52474	165	68,00€	52545	154	177,00€
52264	166	18,60€	52363	130	1,23€	52475	165	62,00€	52546	153	39,60€
52265	166	30,50€	52364	130	2,86€	52476	165	50,00€	52547	150	96,00€
52269	180	7,00€	52365	130	2,46€	52477	165	70,00€	52550	27	92,00€

REF.	Pg.	PVP	REF.	Pg.	PVP	REF.	Pg.	PVP	REF.	Pg.	PVP
52551	201	151,00€	52642	196	32,00€	52729	198	128,00€	52813	185	79,00€
52552	313	128,00€	52643	278	596,00€	52730	198	288,00€	52814	134	528,00€
52555	119	2,38€	52644	314	8,80€	52731	198	38,00€	52815	190	110,00€
52558	119	2,38€	52645	313	0,55€	52732	198	58,00€	52816	190	28,10€
52565	46	11,50€	52646	313	0,50€	52733	198	98,00€	52817	190	23,50€
52566	125	28,00€	52648	143	9,00€	52734	210	51,00€	52818	310	148,00€
52567	125	29,00€	52649	311	5,00€	52735	148	4,85€	52819	246	22,00€
52568	126	28,00€	52650	311	5,00€	52736	148	5,35€	52821	183	28,80€
52569	126	28,00€	52652	310	2,80€	52737	148	5,50€	52822	186	32,00€
52570	316	2,60€	52653	310	3,00€	52738	316	5,00€	52823	191	124,00€
52571	316	2,60€	52655	312	39,70€	52739	316	5,00€	52827	124	46,00€
52572	316	2,60€	52656	312	39,50€	52740	120	690,00€	52828	124	43,00€
52573	316	2,60€	52657	312	37,50€	52742	305	64,00€	52829	314	19,00€
52574	137	69,00€	52658	312	39,70€	52749	168	79,00€	52830	47	24,00€
52575	50,137	119,00€	52659	312	39,70€	52753	27	107,00€	52831	47	18,00€
52583	204	8,50€	52660	313	126,00€	52754	188	54,00€	52832	193	75,00€
52587	52	39,90€	52661	313	290,00€	52757	216	16,00€	52833	192	39,30€
52588	52	45,00€	52662	310	36,50€	52758	139	88,00€	52834	199	195,00€
52589	166	13,00€	52663	310	30,00€	52760	62,216	4,10€	52835	199	272,00€
52591	211	12,00€	52664	312	168,00€	52761	57	8,00€	52836	120	1.100,00€
52592	211	22,00€	52665	308	0,37€	52762	57	9,00€	52838	128	56,00€
52593	211	34,00€	52666	308	0,36€	52765	166	21,70€	52839	64, 128	64,00€
52595	49	64,00€	52667	308	0,76€	52768	299	13,80€	52842	311	11,00€
52596	49	114,00€	52668	308	1,49€	52769	299	14,50€	52843	124	31,60€
52597	49	146,00€	52669	308	2,22€	52770	299	23,00€	52845	270	170,00€
52598	106,281	1.080,00€	52670	308	2,95€	52771	299	23,40€	52846	59	37,80€
52599	189	230,00€	52671	308	3,70€	52772	299	13,90€	52847	59	41,00€
52600	287	884,00€	52672	308	4,45€	52773	299	14,60€	52848	128	88,00€
52601	252	397,00€	52673	310	18,00€	52774	299	14,80€	52849	202	8,50€
52603	26	74,00€	52675	139	84,00€	52775	299	15,20€	52850	210	7,80€
52604	26	78,00€	52676	139	98,00€	52776	299	13,80€	52851	163,343	9,65€
52605	26	76,00€	52677	180	17,00€	52777	299	15,50€	52852	62	6,80€
52606	26	88,00€	52678	180	18,00€	52778	299	14,60€	52857	351	7,50€
52607	181	49,00€	52685	188	88,00€	52779	299	17,10€	52858	184	298,00€
52608	181	44,00€	52687	208	168,00€	52780	299	13,90€	52862	130	1,15€
52609	50	29,00€	52690	193	54,00€	52781	299	14,60€	52864	130	1,20€
52615	179	112,00€	52691	192	54,00€	52782	299	14,80€	52866	130	0,25€
52616	246	44,00€	52692	268	129,00€	52783	299	15,20€	52869	86	52,00€
52617	182	7,00€	52693	210	24,50€	52786	56	14,60€	52870	86	100,00€
52618	301	29,00€	52694	150	49,00€	52787	144	9,00€	52871	86	248,00€
52619	61	23,10€	52696	210	12,00€	52788	162	39,00€	52873	204	11,00€
52620	213	8,80€	52697	210	16,00€	52789	256	15,20€	52874	195	82,00€
52621	215	11,00€	52699	196	22,00€	52791	60,61	18,00€	52875	195	79,00€
52624	194	28,00€	52700	192	20,50€	52794	204	28,00€	52876	160	182,00€
52625	62,176	9,00€	52703	327	22,00€	52795	300	5,80€	52877	56	15,80€
52626	196	46,00€	52711	327	27,50€	52796	205	98,00€	52878	56	11,20€
52627	196	120,00€	52713	19	89,00€	52797	255	198,00€	52879	56	10,10€
52628	256	26,50€	52714	29	15,70€	52798	144	18,00€	52880	53,311	42,00€
52629	184	99,00€	52715	29	10,00€	52801	186,256	26,00€	52881	53,311	17,00€
52633	310	1,00€	52716	29	15,90€	52802	191	54,00€	52882	160	14,00€
52634	81	5,25€	52717	29	11,00€	52804	248	343,00€	52883	116	38,00€
52635	81	4,80€	52718	141	48,00€	52805	248	426,00€	52884	273	73,00€
52636	174	114,00€	52719	330	0,19€	52806	248	742,00€	52885	62	18,00€
52637	202	48,00€	52722	18	87,00€	52807	248	1.714,00€	52886	336	18,00€
52638	62	9,95€	52724	138	381,00€	52809	179	8,50€	52887	336	22,00€
52639	195	123,00€	52725	138	349,00€	52810	153	9,00€	52888	341	24,00€
52640	195	52,00€	52727	198	34,60€	52811	153	9,90€	52889	338	19,00€
52641	195	55,00€	52728	198	68,00€	52812	61	65,00€	52890	339	22,00€

REF.	Pg.	PVP	REF.	Pg.	PVP	REF.	Pg.	PVP	REF.	Pg.	PVP
52891	339	28,00€	52957	57	23,80€	53058	200	193,00€	53141	137	68,00€
52892	338	22,00€	52958	57	28,20€	53059	201	52,00€	53144	257	18,00€
52893	339	26,00€	52959	57	42,00€	53060	151	34,90€	53145	278	39,20€
52894	338	22,00€	52960	57	46,00€	53062	197	99,00€	53146	198	30,50€
52895	340	22,00€	52962	190	42,00€	53063	144	36,70€	53147	142	41,00€
52896	336	26,00€	52963	254	49,00€	53064	144	37,40€	53150	309	24,00€
52897	340	38,00€	52964	58	9,45€	53065	144	36,90€	53151	127	14,00€
52898	340	36,00€	52965	58	9,20€	53066	144	61,00€	53154	31,288	462,00€
52899	337	34,00€	52966	58	9,45€	53067	144	61,00€	53156	29	26,20€
52900	337	34,00€	52967	58	9,40€	53068	144	63,00€	53159	20	289,00€
52901	337	34,00€	52969	151	20,70€	53069	183	98,00€	53162	278	60,00€
52902	287	970,00€	52973	38	59,00€	53070	64	16,20€	53164	32,289	16,50€
52903	287	1.100,00€	52977	162	137,00€	53071	64	26,10€	53165	32,289	19,60€
52904	204	61,00€	52980	279	480,00€	53072	64	31,60€	53166	283	10,50€
52905	56	28,00€	52982	164	53,00€	53073	64	50,00€	53167	283	12,50€
52906	175	38,00€	52985	267	598,00€	53074	15	78,00€	53168	283	19,00€
52908	29	17,00€	52987	116	20,00€	53077	152	62,00€	53177	299	11,90€
52909	29	12,50€	52991	258	10,50€	53078	249	18,00€	53178	299	12,20€
52910	124	39,00€	52992	258	18,00€	53079	168	89,00€	53179	299	12,20€
52912	40,78	91,00€	52998	166	48,00€	53080	168	99,00€	53180	299	12,20€
52913	203	292,00€	52999	266	168,00€	53081	203	115,00€	53181	299	11,90€
52914	156	223,00€	53001	206	242,00€	53082	203	148,00€	53182	299	12,20€
52915	156	199,00€	53007	130	0,42€	53083	48	64,00€	53183	299	12,70€
52916	156	218,00€	53008	179	15,50€	53084	30	24,00€	53184	299	12,20€
52917	156	122,00€	53009	184	42,00€	53085	119	30,00€	53185	299	13,20€
52918	156	146,00€	53010	42	18,00€	53086	216	9,00€	53186	299	13,20€
52919	156	181,00€	53017	34	57,00€	53087	299	11,20€	53187	258	39,00€
52920	156	155,00€	53018	36	119,00€	53088	299	11,50€	53188	258	7,00€
52921	156	117,00€	53025	44	3,50€	53089	299	11,50€	53189	284	128,00€
52922	156	180,00€	53026	44	5,80€	53090	299	11,50€	53190	284	98,00€
52923	156	59,00€	53027	44	9,00€	53091	299	10,20€	53191	171	14,80€
52924	157	52,00€	53028	275	5,80€	53092	299	10,30€	53192	171	52,00€
52925	157	176,00€	53029	275	6,80€	53093	299	10,30€	53196	213	33,00€
52926	157	201,00€	53030	275	12,00€	53094	299	10,20€	53197	152	46,00€
52927	157	59,00€	53031	86	59,00€	53095	48	20,50€	53198	258	9,50€
52928	157	172,00€	53032	86	126,00€	53096	216	28,80€	53200	263	69,00€
52929	157	185,00€	53033	305	21,50€	53102	17	36,00€	53202	145	15,70€
52930	157	117,00€	53037	313	0,50€	53104	25	34,00€	53203	130	0,46€
52931	157	45,00€	53038	313	0,50€	53105	25	37,00€	53204	145	81,00€
52932	157	45,00€	53039	313	0,50€	53106	19	99,00€	53205	144	19,00€
52933	157	194,00€	53040	313	0,50€	53108	18	92,00€	53206	180	38,20€
52934	158	102,00€	53041	187	37,60€	53110	163,343	27,30€	53207	191	118,00€
52935	158	94,00€	53042	204	9,90€	53111	277	19,00€	53208	191	126,00€
52936	158	199,00€	53043	152	53,00€	53112	260	298,00€	53209	273	8,50€
52937	158	265,00€	53044	153	121,00€	53118	211	231,00€	53210	64	48,00€
52938	158	199,00€	53045	126	35,00€	53119	160	52,00€	53211	85	75,00€
52939	158	28,00€	53046	126	39,00€	53120	48	6,00€	53212	14	149,00€
52940	158	235,00€	53047	126	330,00€	53121	48	7,35€	53214	248	285,00€
52941	158	70,00€	53048	126	89,00€	53122	48	9,50€	53215	257	19,00€
52942	158	105,00€	53049	125	89,00€	53124	167	287,00€	53216	115	49,00€
52943	158	75,00€	53051	126	158,00€	53125	167	477,00€	53217	116	47,00€
52944	158	110,00€	53052	126	158,00€	53126	169	243,00€	53218	263	26,00€
52945	158	281,00€	53053	194	12,00€	53127	30	12,00€	53219	16	49,00€
52952	274,288	74,00€	53054	216	6,00€	53129	200	84,00€	53220	279	260,00€
52953	142	38,00€	53055	215	33,00€	53134	169	144,00€	53221	301	4,75€
52955	57	19,80€	53056	200	127,00€	53137	137	38,00€	53222	84	57,00€
52956	57	19,60€	53057	206	149,00€	53140	138	98,00€	53224	160	142,00€

REF.	Pg.	PVP	REF.	Pg.	PVP	REF.	Pg.	PVP	REF.	Pg.	PVP
53225	55	3,50€	53297	233	45,00€	53366	326	14,00€	53443	300	7,55€
53226	171	14,90€	53298	234	91,00€	53367	334	9,50€	53444	22	195,00€
53227	119	28,00€	53299	234	291,00€	53368	334	9,00€	53445	189	17,10€
53229	329	38,70€	53300	234	41,00€	53369	326	14,00€	53449	143	14,00€
53230	163	19,70€	53301	235	44,00€	53370	324	26,00€	53450	143	28,30€
53232	163	39,00€	53302	236	44,00€	53371	325	29,00€	53452	234	26,50€
53235	182	10,40€	53303	236	89,00€	53372	324	26,00€	53453	254	7,00€
53236	182	11,50€	53304	236	279,00€	53373	331	14,50€	53456	207	98,00€
53237	182	12,90€	53305	236	136,00€	53374	332	10,00€	53459	207	66,00€
53238	182	18,40€	53306	240	53,00€	53376	332	10,50€	53463	202	98,00€
53240	212	58,00€	53307	237	38,50€	53377	328	20,00€	53464	184,330	153,00€
53241	306	9,00€	53308	241	55,00€	53378	334	13,00€	53468	54	8,50€
53246	269	1.144,00€	53309	240	285,00€	53380	335	11,50€	53469	73	613,00€
53249	212	192,00€	53310	239	498,00€	53381	331	14,50€	53470	154	176,00€
53250	197	85,00€	53311	238	97,00€	53382	331	11,00€	53472	182	12,00€
53251	210	88,00€	53312	239	127,00€	53383	331	11,50€	53473	182	36,00€
53253	107	98,00€	53313	238	139,00€	53384	196	165,00€	53474	212	94,00€
53256	309	34,00€	53314	238	98,00€	53385	56,343	19,30€	53477	213	36,10€
53258	107	67,00€	53315	244	285,00€	53388	198	90,00€	53478	54	4,55€
53259	218	97,00€	53316	237	34,00€	53389	58	31,50€	53479	54	6,40€
53260	218	168,00€	53317	246	34,00€	53390	60	34,50€	53480	54	19,90€
53261	218	214,00€	53318	245	24,00€	53391	199	86,00€	53481	54	27,40€
53262	218	251,00€	53319	240	18,00€	53393	199	118,00€	53484	276	615,00€
53263	219	57,00€	53320	245	12,00€	53394	211	598,00€	53485	209	140,00€
53264	220	143,00€	53321	246	10,50€	53395	213	16,00€	53486	160	29,30€
53265	219	195,00€	53324	233	12,50€	53396	60	18,30€	53487	61	16,70€
53266	220	224,00€	53325	246	7,50€	53399	45	3,50€	53488	194	61,00€
53267	220	277,00€	53326	226	16,00€	53400	45	5,70€	53489	188	68,00€
53268	221	92,00€	53327	226	11,00€	53401	45	7,40€	53490	189	275,00€
53269	220	50,00€	53328	191	76,00€	53402	45	9,60€	53492	142,353	380,00€
53270	222	70,00€	53330	186	38,00€	53403	45	6,50€	53499	207	29,00€
53271	222	227,00€	53331	50	31,80€	53404	45	6,50€	53500	207	29,00€
53272	222	195,00€	53332	50	34,50€	53405	45	5,30€	53501	184	24,00€
53273	223	75,00€	53339	47	9,50€	53406	45	8,55€	53502	192	38,70€
53274	225	30,50€	53340	329	86,00€	53407	45	12,70€	53503	275	12,00€
53275	228	35,50€	53343	137	285,00€	53408	45	19,30€	53504	351	38,00€
53276	225	160,00€	53344	137	295,00€	53409	45	9,00€	53505	120	77,00€
53277	223	45,00€	53346	52	18,00€	53410	206	92,00€	53506	120	36,00€
53278	224	143,00€	53347	209	100,00€	53411	56	5,00€	53507	302	24,00€
53279	226	97,00€	53348	324	14,00€	53412	56	4,00€	53508	302	14,00€
53280	226	112,00€	53349	324	14,00€	53414	162	49,00€	53509	73	482,00€
53281	225	55,00€	53350	324	14,00€	53415	162	188,00€	53510	351	24,00€
53282	225	48,00€	53351	325	12,50€	53416	143	14,10€	53511	351	23,00€
53283	227	92,00€	53352	325	12,00€	53417	143	26,30€	53512	351	41,00€
53284	224	306,00€	53353	331	18,00€	53418	143	16,90€	53513	351	9,00€
53285	227	56,00€	53354	326	14,00€	53419	311	9,70€	53514	73	990,00€
53286	227	87,00€	53355	334	11,50€	53420	40	72,00€	53517	56	9,50€
53287	227	245,00€	53356	334	11,50€	53421	260	298,00€	53518	249	3,50€
53288	228	72,00€	53357	272,334	7,00€	53422	260	368,00€	53519	114	42,00€
53289	229	45,00€	53358	334	11,50€	53423	269	199,00€	53520	132	228,00€
53290	229	51,00€	53359	333	16,00€	53426	188	39,80€	53522	184	24,00€
53291	229	68,00€	53360	327	18,00€	53427	119	5,00€	53523	229	91,00€
53292	230	116,00€	53361	327	24,00€	53428	125	18,00€	53524	63	51,00€
53293	231	134,00€	53362	326	14,00€	53429	125	18,00€	53525	213	12,00€
53294	233	119,00€	53363	325	34,00€	53430	158	286,00€	53526	283,292	168,00€
53295	232	77,00€	53364	325	16,00€	53434	333	18,00€	53530	116,208	46,00€
53296	233	60,00€	53365	327	14,00€	53441	179	9,80€	53531	150	109,00€

REF.	Pg.	PVP	REF.	Pg.	PVP	REF.	Pg.	PVP	REF.	Pg.	PVP
53532	146,292	119,00€	53603	57	45,00€	53662	209	89,00€	53727	23	198,00€
53533	350	1,50€	53604	57	118,00€	53663	212	8,00€	53728	23	198,00€
53536	129	34,00€	53605	312	141,00€	53664	194	38,00€	53729	213	19,10€
53537	181	14,50€	53606	145	55,00€	53665	215	19,00€	53733	132	238,00€
53538	181	14,50€	53607	145	292,00€	53666	215	28,00€	53734	114	23,70€
53539	208	78,00€	53608	132	98,00€	53667	30	32,00€	53735	181	44,00€
53540	298	23,00€	53609	250	190,00€	53668	30	34,00€	53736	168	98,00€
53541	138	168,00€	53610	250	294,00€	53669	206	45,00€	53737	41	12,50€
53542	138	980,00€	53611	144	27,50€	53670	180	29,50€	53738	41	10,90€
53543	284	13,80€	53612	249	96,00€	53671	51,79	41,00€	53739	41	10,50€
53545	163	35,70€	53613	44	19,50€	53672	83	440,00€	53740	41	9,10€
53547	58	14,70€	53614	44	21,50€	53673	161	80,00€	53741	181	14,00€
53548	58	15,60€	53615	44	34,60€	53674	82	447,00€	53743	28,154	39,70€
53549	58	14,30€	53616	44	10,40€	53675	164	50,00€	53744	151	63,00€
53550	58	14,70€	53617	44	9,25€	53676	164	44,00€	53745	307	6,40€
53551	317	18,95€	53618	44	13,90€	53677	164	55,00€	53746	307	6,40€
53552	317	18,95€	53620	80	88,00€	53678	164	52,00€	53747	307	6,40€
53553	317	18,95€	53621	298	2,50€	53681	134	743,00€	53748	307	6,60€
53556	73	990,00€	53622	298	2,50€	53682	268	98,00€	53749	307	6,70€
53557	73	990,00€	53623	298	2,50€	53683	174	116,00€	53750	307	6,70€
53561	302	28,00€	53624	298	2,50€	53684	266	1.880,00€	53751	307	6,80€
53565	84	258,00€	53625	141	68,00€	53685	168	310,00€	53752	307	6,95€
53566	254	32,00€	53626	140,161	18,00€	53686	69	890,00€	53753	307	7,10€
53567	136,166	43,00€	53627	254	22,50€	53687	272	298,00€	53754	307	7,40€
53568	118	12,00€	53629	147	14,30€	53688	272	495,00€	53755	307	7,50€
53569	118	18,00€	53630	147	18,80€	53689	133	238,00€	53756	307	7,90€
53570	121	154,00€	53631	147	33,50€	53690	122	34,00€	53757	307	7,90€
53572	138,210	348,00€	53632	147	46,00€	53691	122	36,00€	53758	307	8,20€
53573	141	36,00€	53633	147	46,00€	53693	314	521,00€	53759	307	8,50€
53574	28,42	47,00€	53634	147	63,00€	53694	42	18,40€	53760	307	9,60€
53575	43	16,00€	53635	202	85,00€	53695	314	504,00€	53761	69	680,00€
53576	139	189,00€	53636	302	22,00€	53696	215	22,00€	53762	69	680,00€
53577	73	990,00€	53637	210	85,00€	53697	250	398,00€	53763	68	890,00€
53578	73	990,00€	53638	202	243,00€	53698	314	717,00€	53764	68	680,00€
53579	73	990,00€	53639	63	28,60€	53701	197	188,00€	53765	68	890,00€
53580	73	990,00€	53640	63	34,40€	53702	107	28,50€	53766	68	680,00€
53581	146,292	115,00€	53641	63	41,00€	53703	107	41,00€	53767	69	890,00€
53582	146,292	179,00€	53642	63	54,00€	53704	107	42,00€	53768	69	680,00€
53583	146,292	170,00€	53643	63	92,00€	53705	170	80,00€	53769	72,230	178,00€
53584	283,292	119,00€	53644	251	1.238,00€	53706	224	98,00€	53770	72,242	198,00€
53585	283,292	168,00€	53645	251	268,00€	53707	121	153,00€	53771	72,243	158,00€
53586	283,292	158,00€	53646	139,140,161	62,00€	53708	66,68 69,74,76	325,00€	53772	72,243	229,00€
53587	151	44,00€	53647	14	96,00€	53710	344	16,00€	53773	72,241	298,00€
53588	132	164,00€	53648	224	107,00€	53711	344	16,00€	53774	72,242	190,00€
53589	62	12,00€	53649	228	89,00€	53712	344	16,00€	53775	72,244,245	1.109,00€
53590	266	1.190,00€	53650	186	47,00€	53713	343	16,00€	53776	116	19,10€
53591	56	5,50€	53651	235	91,00€	53714	343	16,00€	53777	270	4.352,00€
53592	257	25,00€	53652	191	53,00€	53715	343	19,00€	53778	300	4,50€
53593	145	41,00€	53653	231	207,00€	53716	342	19,00€	53779	263	36,00€
53594	147	54,00€	53654	63	81,00€	53717	342	19,00€	53780	117	14,50€
53595	147	61,00€	53655	213	12,00€	53718	342	19,00€	53781	319	18,00€
53596	318	3,65€	53656	278	198,00€	53719	341	19,00€	53782	107	14,00€
53597	318	3,70€	53657	278	248,00€	53720	341	19,00€	53784	135	148,00€
53598	318	3,95€	53658	278	99,00€	53723	309	68,00€	53785	318	4,80€
53599	207,331	30,30€	53659	278	121,00€	53724	276	46,00€	53786	322	98,00€
53600	284	13,80€	53660	279	146,00€	53725	260	248,00€	53787	319	0,98€
53602	57	30,50€	53661	69	890,00€	53726	133	128,00€	53787O	319	0,98€
									53791	320	4,80€

REF.	Pg.	PVP	REF.	Pg.	PVP	REF.	Pg.	PVP	REF.	Pg.	PVP
53794	320	28,00€	53877	352	430,50€	53951	72,245	1.794,00€	54023	51	13,50€
53796	322	76,00€	53878	352	574,00€	53952	72,245	1.794,00€	54024	51	17,90€
53797	319	0,10€	53879	352	838,50€	53953	16	29,00€	54028	50	28,00€
53798	320	1,95€	53880	270	598,00€	53954	41	8,50€	54029	50	28,00€
53802	322	120,00€	53881	146,292	79,00€	53955	41	10,00€	54030	50	18,80€
53803	320	0,90€	53882	146,292	79,00€	53956	348	353,00€	54031	50	19,30€
53804	320	0,80€	53883	53	18,40€	53957	319	0,26€	54032	35	84,00€
53805	322	220,00€	53884	53	30,20€	53958	214	6,50€	54033	136	49,00€
53806	322	250,00€	53885	53	35,70€	53959	319	0,98€	54034	7	178,00€
53808	321	16,50€	53886	53	20,30€	53960	319	0,98€	54035	10	149,00€
53809	321	8,00€	53887	53	30,30€	53961	319	0,98€	54036	11	99,00€
53811	321	8,90€	53888	53	37,90€	53964	305	9,65€	54037	12	88,00€
53812	321	23,50€	53893	319	5,00€	53965	305	25,80€	54038	13	88,00€
53820	280	388,00€	53895	262	107,00€	53967	60	10,20€	54039	122	154,00€
53822	320	2,50€	53896	262	127,00€	53968	261	49,00€	54040	274	240,00€
53824	320	2,85€	53897	262	140,00€	53969	268	96,00€	54041	35	198,00€
53826	319	16,00€	53898	262	148,00€	53970	286	3.790,00€	54042	303,318	13,00€
53827	320	14,00€	53900	68,80	890,00€	53971	286	468,00€	54043	349	48,00€
53828	320	6,00€	53901	68,80	680,00€	53972	203	550,00€	54044	127	99,00€
53829	320	14,00€	53902	319,320	25,00€	53973	348	284,00€	54045	7	179,00€
53830	320	1.300,00€	53903	214	59,00€	53974	117	38,00€	54046	10	150,00€
53832	320	1,81€	53904	69,80	890,00€	53976	60	9,00€	54047	11	100,00€
53835	321	16,00€	53905	60	7,30€	53977	277	17,50€	54048	12	89,00€
53836	321	16,00€	53906	60	8,65€	53978	175	38,90€	54049	13	88,00€
53838	322	38,00€	53908	60	7,25€	53979	40,80	34,60€	54050	255	980,00€
53839	321	0,25€	53909	60	9,70€	53980	40,80	34,60€	54051	257	39,00€
53840ES	321	6,00€	53910	333	19,00€	53981	277	143,00€	54052	287	1.100,00€
53844	319	2,80€	53911	60	8,80€	53982	277	219,00€	54053	287	248,00€
53845	263	64,00€	53912	67	1.280,00€	53983	167	215,00€	54054	287	268,00€
53849	256	16,10€	53913	67	1.280,00€	53984	317	8,80€	54055	287	220,00€
53850	93,109	14,90€	53914	321,354	75,00€	53985	317	8,80€	54056	287	260,00€
53851	110	88,00€	53915	24,210	65,00€	53986	317	8,80€	54057	287	248,00€
53852	92,110	207,00€	53916	319	3,80€	53987	288,321	9,50€	54058	287	348,00€
53853	110	14,40€	53917	42	9,00€	53988	152	101,00€	54059	287	428,00€
53854	110	27,00€	53919	304	81,00€	53992	333	18,00€	54060	42	6,00€
53855	110	24,80€	53921	169	39,00€	53993	48	77,00€	54061	42	6,00€
53856	92,110	62,00€	53922	169	29,00€	53997	189	48,00€	54066	34,78	83,00€
53857	91,92,111	27,00€	53927	273	66,00€	53999	111	2,00€	54067	286	599,00€
53858	91,92,111	28,80€	53928	21	278,00€	54000	111	2,50€	54068	178	198,00€
53859	92,111	67,00€	53929	273	95,00€	54001	264	285,00€	54069	202	29,50€
53860	92,109	3,65€	53930	350	276,00€	54002	111	3,00€	54070	43	18,00€
53861	92,109	5,45€	53931	351	104,00€	54003	187	104,00€	54071	43	26,50€
53862	254,319	6,00€	53932	57	8,00€	54004	118	23,00€	54072	303,318	38,50€
53863	254,319	3,00€	53934	351	690,00€	54005	41	14,00€	54073	304	70,00€
53864	309	138,00€	53939	66	1.280,00€	54006	69,71	680,00€	54074	304	18,50€
53865	348	48,00€	53940	71,288 290,321	13,20€	54008	111	3,50€	54076	349	9,00€
53866	75	424,00€	53941	71,288 290,321	6,05€	54010	111	4,50€	54078	125	68,00€
53867	74,80	1.095,00€	53942	71,288 290,321	0,50€	54011	111	5,00€	54079	37	83,00€
53868	66,80	1.090,00€	53943	43,77	21,50€	54013	309	35,00€	54081	39	28,00€
53869	67,80	990,00€	53944	43,77	19,50€	54015	60	10,20€	54082	9	188,00€
53870	67,80	990,00€	53945	43,77	18,90€	54016	209	76,00€	54083	51	9,75€
53871	35	60,00€	53946	319	0,83€	54017	166	12,00€	54084	51	13,10€
53872	292	118,00€	53947	282	145,00€	54018	51	9,85€	54085	51	17,80€
53873	253	285,00€	53948	282	324,00€	54019	51	17,90€	54086	51	9,25€
53874	253	398,00€	53949	351	4,50€	54020	349	288,00€	54087	51	17,30€
53875	246	134,00€	53950	351	4,50€	54021	51	13,50€	54088	122	132,00€
53876	238	64,00€				54022	51	9,95€	54089	48	17,50€

REF.	Pg.	PVP	REF.	Pg.	PVP	REF.	Pg.	PVP	REF.	Pg.	PVP
54090	24	56,00€	54159	39	47,00€	54217	235	104,00€	60011	96	175,00€
54091	31,288	441,00€	54160L	127	17,50€	54218	228	142,00€	60012	108	48,00€
54092	223	24,00€	54160R	127	17,50€	54219	221	60,00€	60013	108	80,00€
54093	31	441,00€	54161	127	90,00€	54220	187,222	197,00€	60015	108	138,00€
54097	37	38,90€	54162	127	81,00€	54221	235	111,00€	60016	108	49,00€
54099	48	13,80€	54163	127	80,00€	54222	219	59,00€	60017	108	64,00€
54100	251	265,00€	54164	25	34,00€	54223	231	149,00€	60018	88	306,00€
54101	34	61,00€	54166	304	32,40€	54224	231	64,50€	60019	95	178,00€
54102	297	60,00€	54168	15	49,00€	54225	230	133,00€	60020	94	175,00€
54105	15	33,00€	54169	304	13,80€	54226	244	71,00€	60022	97	470,00€
54106	18,41	89,00€	54170	304	16,50€	54227	221	122,00€	60023	93	212,00€
54108	18	66,00€	54171	350	138,00€	54228	219	187,00€	60024	91	190,00€
54109	17	34,00€	54172	123	81,00€	54229	281	48,00€	60025	91,108	31,60€
54110	35	46,00€	54173	123	87,00€	54230	281	68,00€	60026	91,108	37,90€
54111	163	4,75€	54174	37	139,00€	54231	281	138,00€	60027	103	99,00€
54112	163,197	18,00€	54175	270	34,00€	54232	281	248,00€	60028	92	142,00€
54113	163	7,65€	54176	293	188,00€	54233	290	1.856,00€	60029	104	240,00€
54114	71	248,00€	54177	317	18,95€	54234	71,290	1.856,00€	60030	105	112,00€
54115	39	26,80€	54178	317	18,95€	54235	71,290	1.856,00€	60031	104	142,00€
54116	17	66,00€	54179	317	18,95€	54236	71/290	1.856,00€	60032	99	123,00€
54117	34	74,00€	54180	296	2.400,00€	54237	70	1.887,00€	60033	93	104,00€
54119	39	78,00€	54181	249	25,10€	54238	70	1.887,00€	60034	90	320,00€
54120	37	59,00€	54182	249	34,70€	54239	70	1.887,00€	60035	102	30,00€
54122	115	38,00€	54183	249	38,20€	54240	70	1.887,00€	60037	98	222,00€
54123	115	40,00€	54184	249	44,00€	54241	71,290	120,00€	60038	99	255,00€
54124	115	47,00€	54185	296	390,00€	54245	183	580,00€	60039	103	265,00€
54125	284	152,00€	54186	183	320,00€	54246	294	104,00€	60040	105	440,00€
54126	43	39,00€	54187	37	39,30€	54247	294	99,00€	60041	98	77,00€
54128	104	10,50€	54188	316	19,00€	54248	145	58,00€	60042	100	106,00€
54129	71,290	110,00€	54189	316	19,00€	54249	145	103,00€	60043	100	123,00€
54130	71,290	58,00€	54190	316	19,00€	54250	8	188,00€	60044	89	478,00€
54131	290	58,00€	54191	316	19,00€	54251	139	43,00€	60044C	89	652,00€
54132	71,290	190,00€	54192	316	8,90€	54252	280	199,00€	60045	106	298,00€
54133	122	547,00€	54193	316	8,90€	54253	191	166,00€	70002	346	37,50€
54134	70	1.415,00€	54194	316	8,90€	54254	57	43,00€	70003	346	37,50€
54135	176	82,00€	54195	316	8,90€	54255	257	68,00€	70005	346	42,00€
54136	312	107,00€	54196	297	133,00€	54256	275	48,00€	70009	346	37,50€
54137	260	288,00€	54197	297	118,00€	54257	183,264	318,00€	70011	346	42,00€
54139	188	147,00€	54198	312	59,00€	54258	18	58,00€	70012	346	42,00€
54140	17	36,00€	54199	226	94,00€	54260	231	277,00€	70013	346	44,00€
54141	24	42,00€	54200	244	56,00€	54262	267	88,00€	70014	346	44,00€
54142	62	15,20€	54201	232	37,60€	54263	267	130,00€	70015	346	44,00€
54143	263	249,00€	54202	239	68,00€	54264	267	240,00€	70016	346	44,00€
54144	263	298,00€	54203	239	91,00€	54265	287	1.290,00€	70017	346	44,00€
54145	263	377,00€	54204	232	124,00€	54267	118	9,50€	90003	143	35,20€
54146	263	492,00€	54205	237	49,00€	54270	121	42,00€	90004	143	25,80€
54147	263	198,00€	54206	221	113,00€	54271	121	54,00€	JBMW-BEXP	307	24,50€
54149	38	60,00€	54207	223	38,90€	54299	201	227,00€	METEXP	306,346,353	62,00€
54150	38	23,50€	54208	232	76,00€	60001	101	88,00€	SERIE124	314	710,00€
54151	317	10,90€	54209	232	29,70€	60003	101	110,00€	SERIE262	140,161	199,00€
54152	317	10,90€	54210	230	84,00€	60004	102	79,00€			
54153	317	10,90€	54211	231	74,00€	60005	91	132,00€			
54154	25	37,50€	54212	240	39,40€	60006	92	182,00€			
54155	317	8,80€	54213	238	19,80€	60007	96	170,00€			
54156	317	8,80€	54214	237	96,00€	60008	92	141,00€			
54157	317	8,80€	54215	241	57,00€	60009	94	168,00€			
54158	77	38,00€	54216	234	49,00€	60010	95	170,00€			

SUSCRÍBETE A JBM

Te hacemos llegar las noticias de JBM en formato impreso o digital para que puedas estar al día sobre nuestros avances en el sector.



**¡Todas las novedades
a un clic!**

NOVEDADES

Consulta en nuestro folleto semanal las nuevas adiciones en el stock de JBM. Productos nuevos, ofertas, reposiciones... ¡Todas las novedades!

NEWSLETTER

¡No te pierdas ninguna oferta de JBM! Recibe por correo nuestro boletín semanal con todas las novedades y actualizaciones de stock. ¡Inscríbete ahora!

WHATSAPP

Sé el primero en conocer las promociones más recientes. ¡Ahora las novedades en tu WhatsApp!



Contacta con nosotros y te informaremos sobre cómo darte de alta en cualquiera de nuestros canales de comunicación.

jbm@jbmcamp.com

+34 972 40 57 21 / +34 972 24 55 33



+34 680 240 104

Todas nuestras promociones y novedades a un click

Despiece de cualquier producto JBM

Encuentra tu kit de calado con el código OEM

Pedidos directos a tu distribuidor

Descarga nuestros catálogos y folletos directos a tu móvil

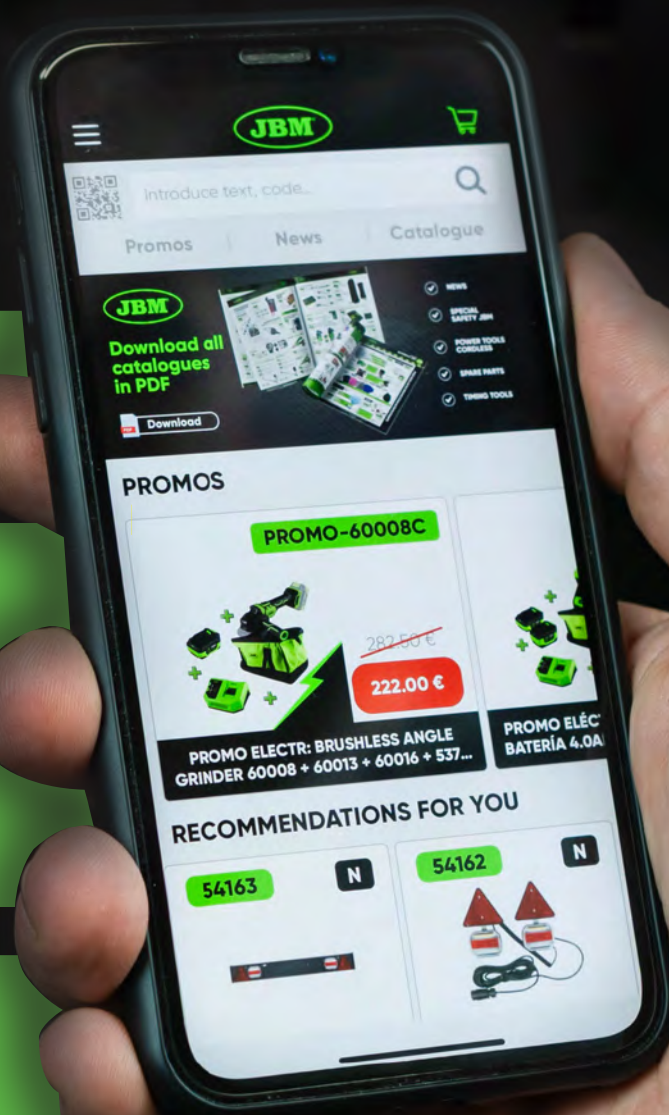



**JBM MÁS
CERCA**
DESCARGA NUESTRA APP





www.jbmcamp.com

 /JBMprofessionaltools

 @jbmtools

 jbmtools

 JBM Campllong S.L.U