





CATÁLOGO 2019 N°12

20
ANIVERSARIO

LUSAN FIJACIONES Y ANCLAJES S.L.

SEDE PRINCIPAL : C/Molinos, nº 20, CP. 29491 Algatocín (Málaga) SPAIN

DELEGACIÓN : Pol. Ind. Pla de la Bruguera, C/Solsonés nº 66

CP. 08211 Castellar del Vallès (Barcelona) SPAIN

E-mail: lusan@lusan.es Web: www.lusan.es





























CERTIFIED M.S.
EN ISO 9001:2015
154ESQS



FIJACIONES METÁLICAS

METAL ANCHORS / FIXATIONS MÉTALLIQUES / METALLFIXIERUNGEN

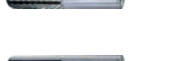
	FT	FIXBOLT TORNILLO 8.8 - CE OP. 12 SLEEVE ANCHOR WITH HEX. HEAD SCREW 8.8 GRADE - CE OP.12 CHEVILLE À DOUILLE AVEC VIS TÊTE HEXAGONALE CLASSE 8.8 - CE OP.12 HÜLSENANKER MIT SECHSKANTSCHRAUBE KLASSE 8.8 - CE OP.12		2-3
	FT2	FIXBOLT TORNILLO INOX. A-2 SLEEVE ANCHOR WITH HEX. HEAD SCREW 8.8 GRADE - CE OP.12 CHEVILLE À DOUILLE AVEC VIS TÊTE HEXAGONALE CLASSE 8.8 - CE OP.12 HÜLSENANKER MIT SECHSKANTSCHRAUBE KLASSE 8.8 - CE OP.12		3
	FT4	FIXBOLT TORNILLO INOX. A-4 SLEEVE ANCHOR WITH HEX. HEAD SCREW - STAINLESS STEEL AISI 316 CHEVILLE À DOUILLE AVEC VIS TÊTE HEXAGONALE EN ACIER INOX. A-4 HÜLSENANKER MIT SECHSKANTSCHRAUBE - EDELSTAHL A-4		4
	FT1	FIXBOLT TORNILLO DIN 7991 SLEEVE ANCHOR WITH SCREW DIN 7991 CHEVILLE À DOUILLE AVEC VIS DIN 7991 HÜLSENANKER MIT SCHRAUBE DIN 7991		4
	FT12	FIXBOLT TORNILLO DIN 7991 INOX. A-2 SLEEVE ANCHOR WITH SCREW DIN 7991 - S.S. AISI 304 CHEVILLE À DOUILLE AVEC VIS DIN 7991 - ACIER INOX. A-2 HÜLSENANKER MIT SCHRAUBE DIN 7991 - EDELSTAHL A-2		5
	FTI	FIXBOLT TORNILLO INVIOLEABLE TX SLEEVE ANCHOR WITH MUSHROOM TX HEAD SCREW 8.8 GRADE (ANTI-THEFT) CHEVILLE À DOUILLE AVEC VIS TÊTE RONDE TX 8.8 (CACHE-TÊTE INAMOVIBLE) HÜLSENANKER MIT RUNDKOPFSCHRAUBE TX 8.8 (INNENSECHSRUND)		5
	FA	FIXBOLT ARO SLEEVE ANCHOR EYE CHEVILLE À DOUILLE AVEC PITON HÜLSENANKER MIT AUGENSCHRAUBE		6
	FAE	FIXBOLT ARO ESTAMPADO FORGED SLEEVE ANCHOR EYE CHEVILLE À DOUILLE AVEC PITON FORGÉ HÜLSENANKER MIT GESCHMIEDETE AUGENSCHRAUBE		6
	FG	FIXBOLT GANCHO SLEEVE ANCHOR HOOK CHEVILLE À DOUILLE AVEC CROCHET HÜLSENANKER MIT HAKEN		7
	FGE	FIXBOLT GANCHO ESTAMPADO FORGED SLEEVE ANCHOR HOOK CHEVILLE À DOUILLE AVEC CROCHET FORGÉ HÜLSENANKER MIT GESCHMIEDETE HAKEN		7
	FA2	FIXBOLT ARO INOX. A-2 SLEEVE ANCHOR EYE - STAINLESS STEEL AISI 304 CHEVILLE À DOUILLE AVEC PITON - ACIER INOX. A-2 HÜLSENANKER MIT AUGENSCHRAUBE - EDELSTAHL A-2		8
	FG2	FIXBOLT GANCHO INOX. A-2 SLEEVE ANCHOR HOOK - STAINLESS STEEL AISI 304 CHEVILLE À DOUILLE AVEC CROCHET - ACIER INOX. A-2 HÜLSENANKER HAKEN - EDELSTAHL A-2		8
	SNZ	ANCLAJE ANILLA SN CINCADO WEDGE ANCHOR - ZINC PLATED GOIJON D'ANCRAGE EN ACIER ZINGUÉ ANKER MIT FEINBLECH VERZINKT		9
	SNH1	ANCLAJE ANILLA SN HOMOLOGADO - CE OP. 1 WEDGE ANCHOR - CE OPT.1 GOIJON D'ANCRAGE - CE OP.1 ANKER MIT FEINBLECH - CE OPT.1		10
	SPS	PROTECTOR SÍSMICO "SPS" "SPS" SEISMIC PROTECTOR PROTECTEUR SISMIQUE "SPS" SEISMISCHER PROTEKTOR "SPS"	NEW 	11
	SNH	ANCLAJE ANILLA SN HOMOLOGADO - CE OP. 7 WEDGE ANCHOR - CE OPT.7 GOIJON D'ANCRAGE - CE OP.7 ANKER MIT FEINBLECH - CE OPT.7		12
	SNA2	ANCLAJE ANILLA SN INOXIDABLE A-2 STAINLESS STEEL AISI 304 WEDGE ANCHOR GOIJON D'ANCRAGE EN ACIER INOX. A-2 ANKER MIT FEINBLECH - EDELSTAHL A-2		13
	SNA4	ANCLAJE ANILLA SN INOX. A-4 STAINLESS STEEL AISI 316 WEDGE ANCHOR GOIJON D'ANCRAGE EN ACIER INOX. A-4 ANKER MIT FEINBLECH - EDELSTAHL A-4		13
	SNHA4	ANCLAJE ANILLA SN INOX. A-4 HOMOLOGADO - CE OP. 7 STAINLESS STEEL AISI 316 WEDGE ANCHOR - CE OPT.7 GOIJON D'ANCRAGE EN ACIER INOX. A-4 - CE OP.7 ANKER MIT FEINBLECH - EDELSTAHL A-4 - CE OPT.7		14
	EM	EXPANSIONADOR MANUAL MANUAL SETTING TOOL OUTIL POUSSOIR WERKZEUG FÜR DIE MONTAGE DE DÜBELS, ZU HÄMMERN		15
	SHZ	ANCLAJE HEMBRA SH CINCADO ZINC PLATED DROP-IN ANCHOR CHEVILLE DE FRAPPE EN ACIER ZINGUÉ VERZINKTER DÜBEL MIT INNENKONUS, ZU HÄMMERN		15
	SHA2	ANCLAJE HEMBRA SH INOXIDABLE A-2 STAINLESS STEEL AISI 304 DROP IN ANCHOR CHEVILLE DE FRAPPE EN ACIER INOX. A-2 EDELSTAHL A-2 DÜBEL MIT INNENKONUS, ZU HÄMMERN		15





FIJACIONES METÁLICAS

METAL ANCHORS / FIXATIONS MÉTALLIQUES / METALLFIXIERUNGEN

	SHA4	ANCLAJE HEMBRA SH INOX. A-4 STAINLESS STEEL AISI 316 DROP IN ANCHOR CHEVILLE DE FRAPPE EN ACIER INOX. A-4 EDELSTAHL A-4 DÜBEL MIT INNENKONUS, ZU HÄMMERN	16
	TPE	TACO PARA PISCINA ESCAMOTEABLE RETRACTABLE POOL SET SET POUR PISCINE ESCAMOTABLE SCHWIMMBAD SET EINZIEHBAR	16
	TL	TACO DE LATÓN KNURLED BRASS ANCHOR CHEVILLE EN LAITON MOLETÉ GERANDELTER DÜBEL AUS MESSING	17
	TLC	TACO DE LATÓN CON COLLARÍN KNURLED BRASS ANCHOR WITH COLLARD CHEVILLE EN LAITON MOLETÉ AVEC COLLETTETTE GERANDELTER DÜBEL AUS MESSING MIT SAUM	17
	CP/CPM	CONJUNTO PARA PISCINA POOL SET SET POUR PISCINE SCHWIMMBAD SET	17
	MS/MS2	MANGUITO SEPARADOR REDONDO ROUNDED STEEL COUPLING NUT MANCHON CYLINDRIQUE RUNDENÜBERWURFMUTTERN	18
	MSE/MSE2	MANGUITO SEPARADOR HEXAGONAL HEXAGONAL STEEL COUPLING NUT MANCHON HEXAGONAL SECHSKANTÜBERWURFMUTTERN	18
	SZ1	ANCLAJE TORNILLO GRANDES CARGAS SZ1 - CE OPCIÓN 1 HIGHLOADS STEEL ANCHOR GRADE 8.8 - CE OPT.1 CHEVILLE POUR CHARGES LOURDES CLASSE 8.8 - CE OP.1 SCHWERLASTANKER KLASSE 8.8 - OPT.1	 19
	TH	TORNILLO DIRECTO HORMIGÓN DIRECT FIXING SCREW FOR CONCRETE VIS DE FIXATION DIRECTE POUR LE BÉTON GERADE-BETONSCHRAUBE	20
	THCP	TORNILLO DIRECTO HORMIGÓN C/PEQUEÑA DIRECT FIXING SCREW REDUCED HEAD FOR CONCRETE VIS DE FIXATION DIRECTE TÊTE REDUIT POUR LE BÉTON GERADE-BETONSCHRAUBE MIT ZYLINDERKOPF	 20
	THE	TORNILLO DIRECTO HORMIGÓN HEXAGONAL DIRECT FIXING SCREW FOR CONCRETE WITH HEXAGONAL HEAD VIS DE FIXATION DIRECTE POUR LE BÉTON AVEC TÊTE HEXAGONALE GERADE-SECHSKANTBETONSCHRAUBE	21
	THE4	TORNILLO DIRECTO HORMIGÓN HEXAGONAL INOX. A-4 STAINLESS STEEL AISI 316 DIRECT FIXING SCREW FOR CONCRETE WITH HEXAGONAL HEAD VIS DE FIXATION DIRECTE POUR LE BÉTON AVEC TÊTE HEXAGONALE INOX. A-4 GERADE-SECHSKANTBETONSCHRAUBE AUS EDELSTAHL A-4	21
	THEH	TLLO. DIRECTO HORMIGÓN HEX. HOMOLOGADO ZN - CE OP.1 ZINC PLATED HEX. CONCRETE SCREW - CE OPT.1 VIS DE FIXATION DIRECTE POUR LE BÉTON AVEC TÊTE HEX. - CE OPT.1 SECHSKANT-BETONSCHRAUBE VERZINKT - CE OPT.1	 22
	HXS	TORNILLO DIRECTO HORMIGÓN CABEZA AVELLANADA ZN - CE OP.1 ZINC PLATED FLAT CSK HEAD WITH RIBS CONCRETE SCREW - CE OPT.1 VIS ZINGUÉ À BÉTON BREVETÉ TÊTE FRAISÉE PLATE - CE OP.1 SENKKOPF-BETONSCHRAUBE MIT FRÄSRIPPEN, VERZINKT - CE OPT.1	 23
	HXB	TORNILLO DIRECTO HORMIGÓN DOBLE ROSCA ZN - CE OPCIÓN 1 ZP. DUAL TH-READ CONCRETE SCREW WITH NUT AND WASHER - CE OPT.1 VIS ZINGUÉ À BÉTON DOUBLE FILETAGE AVEC ÉCROU ET RONDELLE - CE OP.1 DOPPELGEWINDE-BETONSCHRAUBE MIT MUTTER UND SCHEIBE - CE OPT.1	 23
	HXT	TLLO. DIRECTO HORMIGÓN CABEZA ABOMBADA SST MUSH-ROOM HEAD CONCRETE SCREW, SST VIS À BÉTON BREVETÉ TÊTE RONDE SST RUNDKOPF-BETONSCHRAUBE SST	23
	MCT	CÁPSULA METAL + TORNILLO DIN 933 SLEEVE ANCHOR METAL WITH FIXED CONE - SCREW DIN 933 CHEVILLE À DOUILLE EN ACIER AVEC VIS DIN 933 HÜLSENANKER MIT SECHSKANTSCHRAUBE DIN 933	24
	MCA	CÁPSULA METAL ARO SLEEVE ANCHOR METAL WITH FIXED CONE - EYE BOLT CHEVILLE À DOUILLE EN ACIER AVEC PITON HÜLSENANKER MIT AUGENSCHRAUBE	24
	MCG	CÁPSULA METAL GANCHO SLEEVE ANCHOR METAL WITH FIXED CONE - HOOK BOLT CHEVILLE À DOUILLE EN ACIER AVEC CROCHET HÜLSENANKER MIT RUNDHAKEN	24
	MC	CÁPSULA METAL SLEEVE ANCHOR METAL WITH FIXED CONE CHEVILLE À DOUILLE EN ACIER HÜLSENANKER	24
	ZT	ZAMAK TORNILLO DIN 933 SLEEVE ANCHOR ZAMAK WITH FIXED CONE AND SCREW DIN 933 CHEVILLE À DOUILLE ZAMAK AVEC CÔNE FIXE ET VIS DIN 933 HÜLSENANKER MIT FESTEM KONUS UND SCHRAUBE DIN 933	25
	ZA	ZAMAK ARO SLEEVE ANCHOR ZAMAK WITH FIXED CONE AND EYE CHEVILLE À DOUILLE ZAMAK AVEC CÔNE FIXE ET PITON HÜLSENANKER MIT FESTEM KONUS UND AUGENSCHRAUBE	25





















FIJACIONES METÁLICAS

METAL ANCHORS / FIXATIONS MÉTALLIQUES / METALLFIXIERUNGEN

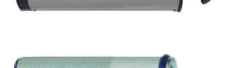
	ZG	ZAMAK GANCHO SLEEVE ANCHOR ZAMAK WITH FIXED CONE AND HOOK CHEVILLE À DOUILLE ZAMAK AVEC CÔNE FIXE ET CROCHET HÜLSENANKER MIT FESTEM KONUS UND RUNDHAKEN	25
	ZC	ZAMAK CÁPSULA SLEEVE ANCHOR ZAMAK WITH FIXED CONE CHEVILLE À DOUILLE ZAMAK AVEC CÔNE FIXE HÜLSENANKER MIT FESTEM KONUS	25
	EXPLAT	ANCLAJE EXPANDIBLE PARA CARTÓN-YESO CON TORNILLO COMBI PLASTERBOARD WALL ANCHOR CHEVILLE À DOUILLE POUR PLAQUES DE PLÂTRE HÜLSENANKER FÜR GIPSKARTON	26
	AP	ALICATES PARA ANCLAJES EN MATERIALES HUECOS TOOLS FOR HOLLOW WALL ANCHORS INSTALLING OUTILS POUR LA MISE EN ŒUVRE DES CHEVILLES POUR MURS VIDES WERKZEUGE FÜR DIE MONTAGE VON DÜBEL FÜR LEEEREN WÄNDEN	26







FIJACIONES QUÍMICAS

CHEMICAL ANCHORS / FIXATIONS CHIMIQUES / CHEMISCHE VERANKERUNGEN

	POLI	ANCLAJE RESINA POLIESTER - CE OP.7 POLYESTER RESIN ANCHOR CHEVILLE RÉSINE POLYESTER POLIESTERHARZ-ANKER		27
	POLIS	ANCLAJE RESINA POLIESTER SIN ESTIRENO - CE OP.7 FREE STYRENE POLYESTER RESIN ANCHOR CHEVILLE RÉSINE POLYESTER SANS STYRÈNE POLIESTERHARZ-ANKER STYROLFREI		27
	EPOX	ANCLAJE RESINA EPOXYACRILATO - CE OP.7 EPOXYACRYLATE RESIN ANCHOR CHEVILLE RÉSINE EPOXYACRYLATE EPOXIDHARZ-ANKER		27
	VINIE	ANCLAJE RESINA VINILESTER SIN ESTIRENO ECO - CE OP.7 FREE STYRENE VINYLESTER RESIN ANCHOR CHEVILLE RÉSINE VINILESTER SANS STYRÈNE VINILESTERHARZ-ANKER STYROLFREI		28
	VINI	ANC. RESINA VINILESTER SIN ESTIRENO PLUS - CE OP.1 FREE STYRENE VINYLESTER PLUS RESIN ANCHOR CHEVILLE RÉSINE VINILESTER PLUS SANS STYRÈNE VINILESTERPLUS-HARZ-ANKER STYROLFREI		28
	PSS / PSG	PISTOLAS PARA RESINA - SILICONA (280 - 310 ml.) HAND GUNS FOR RESIN - SILICONE PISTOLETS POUR RÉSINE - SILICONE HANDPISTOLE FÜR HARZ - SILIKON		29
	PRA / PR PRBE	PISTOLAS PARA RESINA (380 - 410 ml.) HAND GUNS FOR RESIN PISTOLETS POUR RÉSINE HANDPISTOLE FÜR HARZ	NUEVO	29
	MPCO MPSC	MALETÍN DE RESINA "TRAILBOX" TRAILBOX RESIN CASE MALETTE ET RÉSINE TRAILBOX TRAILBOX CASE FÜR HARZ		30
	MP / ME MPS / MV	MALETÍN DE RESINA PROFESIONAL PROFESSIONAL RESIN CASE MALETTE ET RÉSINE PROFESSIONNELLE PROFESSIONAL CASE FÜR HARZ		30
	BO / BO12	BOQUILLA PARA RESINA STATIC MIXER FOR CHEMICAL CARTRIDGES CANULE MÉLANGEUSE POUR RÉSINE STATISCHE MISCHER FÜR HARZ		31
	C1/C2/C3	CEPILLO LIMPIADOR BRUSH BROSSE KLEIDERBÜRSTE		31
	BOMBAP	BOMBA DE SOPLADO BLOWER PUMP POMPE SOUFFLANTE AUSBLASPUMPE		31
	SHR	ANCLAJE HEMBRA PARA RESINA STEEL BUSH WITH INTERNAL THREAD FOR CHEMICAL ANCHOR MANCHON AVEC FILETAGE INTÉRIEUR POUR ANCRAGE CHIMIQUE INNENGEWINDEHÜLSE FÜR CHEMISCHE VERANKERUNG		31
	TA / TAE	TAMICES PERFORATED SLEEVES FOR CHEMICAL ANCHOR PASSOIRES POUR ANCRAGE CHIMIQUE SIEBHÜLSE FÜR CHEMISCHE VERANKERUNG		32
	VRZ	VARILLA, TUERCA Y ARANDELA PARA RESINA ROD, NUT & WASHER FOR CHEMICAL ANCHOR TIGE FILETÉE, ÉCROU ET RONDELLE POUR ANCRAGE CHIMIQUE GEWINDESTANGE MIT SECHSKANTMÜTTER UND SCHEIBE FÜR CHEMISCHE VERANKERUNG		32
	SQR	CÁPSULA QUÍMICA ROTACIÓN SQR SPIN IN CHEMICAL ANCHOR CAPSULE SCÉLLEMENT CHIMIQUE PAR AMPOULE DE ROTATION VERBUNDANKER		33





FIJACIONES QUÍMICAS

CHEMICAL ANCHORS / FIXATIONS CHIMIQUES / CHEMISCHE VERANKERUNGEN

	SER	ESPÁRRAGO QUÍMICO ROTACIÓN SER CINCADO ZINC PLATED CHEMICAL ANCHOR STUD 45° SLICED, WITH NUT AND WASHER TIGE FILETÉE COUPÉE À 45° AVEC ÉCROU ET RONDELLE EN ACIER ZINGUÉ GEWINDESTANGE 45° GESCHNITTEN MIT SCHRAUBENMUTTER UND SCHEIBE		33
	SER4	ESPÁRRAGO QUÍMICO ROTACIÓN SER INOXIDABLE A-4 CHEMICAL ANCHOR STUD 45° SLICED, WITH NUT AND WASHER - SS. AISI 316 TIGE FILETÉE COUPÉE À 45° AVEC ÉCROU ET RONDELLE - ACIER INOX. A-4 GEWINDESTANGE 45° GESCHNITTEN MIT SCHEIBE EDELSTAHL A-4		33
	GAP	GRAPA VENTILADA INOXIDABLE A-2 STAINLESS STEEL, AISI 304 STAPLE CRAMPON POUR MORTIER EN ACIER INOX. A-2 HEFTKLAMMER AUS EDELSTAHL A-2		34
	GAS / GAD	GRAPA PARA AMORTERAR "Z" INOXIDABLE AISI 302 STAINLESS STEEL, AISI 302 STAPLE CRAMPON POUR MORTIER EN ACIER AISI 302 HEFTKLAMMER AUS EDELSTAHL AISI 302		34
	SPRAYZ / SPRAYA2	SPRAYS DE GALVANIZADO EN FRÍO - CINCADO / INOXIDABLE COLD GALVANIZING SPRAY SPRAY POUR GALVANISATION À FROID SPRAY FÜR COLD GALVANISIERTEM		35

FIJACIONES PARA ANDAMIOS Y SOLARES

SOLAR FASTENERS & SCAFFOLD ANCHORS / FIXATIONS SOLAIRES ET POUR ÉCHAFAUDAGES / SOLARBEFESTIGUNGS UND GERÜSTANKER

	AROZ	ARO ANDAMIO WELDED EYEBOLT FOR SCAFFOLDS PITON POUR FIXATION D'ÉCHAFAUDAGE GESCHWEISSTE RINGSCHRAUBE FÜR GERÜSTE		36
	TN14100	TACO NYLON PARA ARO ANDAMIO NYLON PLUG FOR SCAFFOLDS EYEBOLT CHEVILLE NYLON POUR FIXATION D'ÉCHAFAUDAGE NYLONDÜBEL FÜR GERÜSTE RINGSCHRAUBE		36
	TAA	TAPÓN DE NYLON PARA ARO ANDAMIO CAP FOR WALLPLUG BOUCHON POUR FORET KAPPE FÜR WANDSTECKLÖCHERN		36
	FHRC	FIXBOLT HEMBRILLA RABO DE CERDO SLEEVE ANCHOR BENT HOOK CHEVILLE À DOUILLE AVEC CROCHET PLIÉ HÜLSENANKER MIT VERBOGEN-HAKEN		36
	CESA2 FES212C	FIJACIONES PARA CAPTADORES TÉRMICOS Y FOTOVOLTAICOS ANCHORS FOR THERMAL COLLECTORS AND PHOTOVOLTAICS MODULES ANCRAGES POUR CAPTEURS THERMIQUES ET PHANNEAUX PHOTOVOLTAIQUES ANKER FÜR THERMISCHE KOLLEKTOREN UND PHOTOVOLTAIK MODULES		37

FIJACIONES DE NYLON

NYLON FIXINGS / FIXATIONS DE NYLON / NYLONFIXIERUNGEN

	BN/BB/BZ BR/BV/BA/BG	BRIDAS DE NYLON POLYAMIDA 6.6 NYLON CABLE TIES COLLIERS DE SERRAGE EN NYLON KABELBINDER AUS NYLON		38 - 39
	BRB / BRN	BRIDAS DE NYLON RECUPERABLES EN BLANCO Y NEGRO NYLON RECOVERABLE CABLE TIES COLLIERS RÉCUPÉRABLES EN NYLON LÖSBARE KABELBINDER AUS NYLON		40
	BS / BSP	BRIDAS DE SEGURIDAD DE POLIPROPILENO POLYPROPYLENE TAMPER EVIDENT SEALS SCÉLLÉS DE SÉCURITÉ EN POLYPROPILÈNE SICHERUNGSPLOMBE AUS POLYPROPYLEN		40
	TB / TBB TBG	TACO FIJACIÓN PARA BRIDAS DE NYLON NYLON CABLE TIES WALL PLUG TAGUET POUR COLLIER EN NYLON NYLONDÜBEL FÜR KABELBINDER		41
	BASEAD	BASE ADHESIVA PARA BRIDAS DE NYLON NYLON SQUARE BASE WITH DUAL-ADHESIVE EMBASE CARRÉE EN NYLON AVEC BI-ADHÉSIVE MONTAGESOCKEL VIERECKIG AUS NYLON GERICHTET MIT KLEBESTREIFEN		41
	TENSORE	TENSOR DE BRIDAS COLLAR FASTENING METAL PLIER TENSEUR DE COLLIER DE SERRAGE KABELSCHELLENZANGE AUS METAL		41
	BT / TBR	BRIDAS DE NYLON PARA TUBO NYLON PIPE FLANGE COLLIERS DE TUBE EN NYLON ROHRFLANSCH AUS NYLON		42
	ANU	ABRAZADERA DE NYLON UNIVERSAL UNIVERSAL NYLON PIPE FLANGE COLLIERS DE TUBE UNIVERSEL EN NYLON UNIVERSAL ROHRFLANSCH AUS NYLON	NOUEVO NEW	42

FIJACIONES DE NYLON
NYLON FIXINGS / FIXATIONS DE NYLON / NYLONFIXIERUNGEN



LUXRING / LUXRINGD
LUXRINGQ

ABRAZADERA DE NYLON "LUXRING"
PIPES NYLON WALL PLUG
TAQUET POUR TUBES EN NYLON
NYLONDÜBEL FÜR ROHRE

NUEVO
NEW

43



TN

TACO DE NYLON
NYLON PLUG
CHEVILLE NYLON
NYLONDÜBEL

44



TNC

TACO DE NYLON CON COLLARÍN
NYLON PLUG WITH COLLAR
CHEVILLE NYLON AVEC COLLERETE
NYLONDÜBEL MIT SAUM

44



GTX

TACO DE NYLON GTX
GTX NYLON PLUG
CHEVILLE NYLON GTX
NYLONDÜBEL GTX

45



TNU

TACO DE NYLON UNIVERSAL
UNIVERSAL NYLON PLUG
CHEVILLE NYLON UNIVERSELLE
NYLONDÜBEL UNIVERSAL

45



VZ

TACO DE NYLON VZ
VZ NYLON PLUG
CHEVILLE NYLON VZ
NYLONDÜBEL VZ

46



CLIPBOX

CLIPBOX VZ - TACO DE NYLON VZ CON TORNILLO
VZ CLIPBOX - VZ NYLON PLUG WITH SCREW
CLIPBOX VZ - CHEVILLE NYLON VZ AVEC VIS
CLIPBOX VZ - NYLONDÜBEL VZ MIT SCHRAUBE

46



VS

TACO DE NYLON NUDDO VS
VS MULTI-PURPOSE NYLON PLUG
CHEVILLE UNIVERSELLE RALLONGÉE EN NYLON VS
UNIVERSAL-LANGSCHAFTDÜBEL AUS NYLON VS

47



VSTC

TACO DE NYLON VS NUDDO + TORNILLO CÓNICO TX
VS MULTI-PURPOSE NYLON ANCHOR WITH COUNTERSUNK TX SCREW
CHEVILLE UNIVERSELLE RALLONGÉE EN NYLON VS AVEC VIS TX
UNIVERSAL-LANGSCHAFTDÜBEL AUS NYLON VS MIT SENKKOPF-HOLZSCHRAUBE



48



VSTCA4

TACO DE NYLON VS NUDDO + TLLC. CÓNICO TX INOXIDABLE A-4
VS MULTI-PURPOSE NYLON ANCHOR WITH COUNTERSUNK TX SCREW SS, AISI 316
CHEVILLE UNIVERSELLE RALLONGÉE EN NYLON VS AVEC VIS TX INOX. A-4
UNIVERSAL-LANGSCHAFTDÜBEL AUS NYLON VS MIT HOLZSCHRAUBE ED. A-4



48 - 49



VST

TACO DE NYLON VS NUDDO + TORNILLO HEXAGONAL TX
VS MULTI-PURPOSE NYLON ANCHOR WITH HEXAGONAL TX SCREW
CHEVILLE UNIVERSELLE RALLONGÉE EN NYLON VS AVEC VIS TX
UNIVERSAL-LANGSCHAFTDÜBEL AUS NYLON VS MIT SPECIAL-HOLZSCHRAUBE



49



VSTA4

TACO DE NYLON VS NUDDO + TLLC. HEXAGONAL TX INOXIDABLE A-4
VS MULTI-PURPOSE NYLON ANCHOR WITH HEXAGONAL TX SCREW - SS, AISI 316
CHEVILLE UNIVERSELLE RALLONGÉE EN NYLON VS AVEC VIS TX INOX. A-4
UNIVERSAL-LANGSCHAFTDÜBEL AUS NYLON VS MIT SPECIAL-HOLZSCHRAUBE ED. A-4



50



VSDR

TACO DE NYLON VS NUDDO + TORNILLO DOBLE ROSCA
VS MULTI-PURPOSE NYLON ANCHOR WITH SOCKET RECESS DUAL THREAD SCREW
CHEV. UNIVERSELLE RALLONGÉE EN NYLON VS AVEC VIS DOUBLE FILETAGE À SIX PANS CREUX
UNIVERSAL-LANGSCHAFTDÜBEL MIT INNENSECHSKANTSCHRAUBE MIT DOPPELTEN GEWINDE

50



VSDRA4

TACO DE NYLON VS NUDDO + TLLC. DOBLE ROSCA INOXIDABLE A-4
VS MULTI-PURPOSE NYLON ANCHOR WITH DUAL THREAD SCREW SS, AISI 316
CHEVILLE UNIVERSELLE RALLONGÉE EN NYLON VS AVEC VIS DOUBLE FILET INOX. A-4
UNIVERSAL-LANGSCHAFTDÜBEL VS MIT DOPPELTEN GEWINDE SCHRAUBE EDELSTAHL A-4

51



VSTI

TACO DE NYLON VS NUDDO + TORNILLO INVOLABLE TX
VS MULTI-PURPOSE NYLON ANCHOR WITH SECURITY TX SCREW
CHEVILLE UNIVERSELLE RALLONGÉE EN NYLON VS AVEC VIS INVOLABLE TX
UNIVERSAL-LANGSCHAFTDÜBEL AUS NYLON VS MIT SICHERHEITSSCHRAUBE



51



TNM

TACO DE NYLON PARA MARCOS
NYLON FRAME ANCHOR ASSEMBLED
CHEVILLE CADRE EN NYLON RALLONGÉE ASSEMBLÉE
LANGSCHAFTDÜBEL AUS NYLON FÜR FENSTERRAHMEN

52



TNT

TACO DE NYLON TRIPLE EXPANSIÓN
EXTENDED NYLON ANCHOR WITH SIX WINGS
CHEVILLE NYLON AVEC SIX AILETTES
NYLON-LANGSCHAFTDÜBEL MIT SECHS FLÜGEL

52



TNTT

TACO DE NYLON TRIPLE EXPANSIÓN + TORNILLO DIN 571 CINCADO
EXT. NYLON ANCHOR WITH SIX WINGS AND HEX. WOOD SCREW DIN 571
CHEVILLE NYLON AVEC SIX AILETTES ET VIS À BOIS TÊTE HEX. DIN 571
NYLON-LANGSCHAFTDÜBEL MIT SECHS FLÜGEL UND DIN 571

53



TNTTC

TACO DE NYLON TRIPLE EXPANSIÓN + TORNILLO CÓNICO PZ
EXT. NYLON ANCHOR WITH SIX WINGS AND COUNTERSUNK WOOD SCREW
CHEVILLE NYLON AVEC SIX AILETTES ET VIS CONIQUE
NYLON-LANGSCHAFTDÜBEL MIT SECHS FLÜGEL UND HOLZSCHRAUBE

53



TCC

TACO CLAVO CABEZA CÓNICA
NYLON FAST ANCHOR WITH COUNTERSUNK COLLAR
CHEVILLE PRÉMONTE À FRAPPER
NYLONDÜBEL MIT SENKSAUM, MIT VERZINKTER SENKKOPF-NAGELSCHRAUBE

54



TCCI

TACO CLAVO CABEZA CÓNICA INOXIDABLE A-2
NYLON FAST ANCHOR WITH COUNTERSUNK COLLAR - SS, AISI 304
CHEVILLE PRÉMONTE À FRAPPER - INOX A-2
NYLONDÜBEL MIT SENKSAUM, MIT SENKKOPF-NAGELSCHRAUBE - EDELSTAHL A-2

54



TCP

TACO CLAVO CABEZA PLANA
NYLON FAST ANCHOR WITH FLAT COLLAR
CHEVILLE PRÉMONTE CYLINDRIQUE À FRAPPER
NYLONDÜBEL MIT ZYLINDERSAUM, MIT VERZINKTER SENKKOPF-NAGELSCHRAUBE

55

FIJACIONES DE NYLON
NYLON FIXINGS / FIXATIONS DE NYLON / NYLONFIXIERUNGEN

















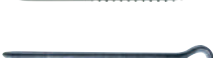





	TCA	TACO CLAVO ABRAZADERA NYLON FAST ANCHOR WITH DOUBLE THREAD CHEVILLE PRÉMONTE AVEC VIS POUR COLLIER ET CRAMPON NYLONDÜBEL MIT ZYLINDERSAUM, MIT VERZINKTER DOPPELGEWINDESCHRAUBE	55
	FN	TACO DE NYLON FN NYLON ANCHOR WITH STEEL CONICAL EXPANSION NUT CHEVILLE NYLON AVEC ÉCROU EN LAITON À EXPANSION NYLONDÜBEL MIT SPREIZ-SCHRAUBEN MUTTER AUS MESSING	56
	FNT	TACO DE NYLON FN + TORNILLO DIN 933 CINCADO NYLON ANCHOR WITH STEEL CONICAL EXPANSION NUT AND HEX. SCREW DIN 933 CHEVILLE NYLON AVEC ÉCROU EN LAITON À EXPANSION ET VIS TÊTE HEX. DIN 933 NYLONDÜBEL MIT SPREIZ-SCHRAUBEN MUTTER AUS MESSING UND DIN 933	56
	RASTREL	TACO RASTREL EXPRESS NAIL FOR LIGHT FASTENINGS CHEVILLE ÉLASTIQUE POUR FIXATION DE LITEAUX ELASTIC SPRUNGGELENK FÜR SCHELEN UND LEICHT FIXIEREN	56
	TPZ / TPN	TACO AUTOPERFORANTE PARA CARTÓN-YESO / NYLON Y ZAMAK SELF DRILLING ANCHOR FOR PLASTERBOARD CHEVILLE AUTOPERCEUSE POUR PLAQUES DE PLÂTRE SELBSTBOHRENDEN-DÜBEL FÜR GIPSKARTON	57
	TPA	TACO DE NYLON CON ALAS PARA CARTÓN-YESO WINGS ANCHOR FOR PLASTERBOARD CHEVILLE AVEC AILETTES POUR PLAQUES DE PLÂTRE DÜBEL FÜR GIPSKARTON MIT ZWEI FLÜGEL	57
	TP	TACO DE PLÁSTICO BLANCO WHITE WINGS PLASTIC PLUG CHEVILLE PLASTIQUE BLANC KUNSTSTOFF-DÜBEL WEISS	58
	BRS / BRG	BASCULANTES GRAVITY TOGGLES CHEVILLE BASCULENTE KIPPDÜBEL	58
	WC/WCA2/WCLA/FL FLA2/FLN/WCH	FIJACIONES PARA WC WC FIXATIONS FIXATIONS POUR WC BEFESTIGUNGEN FÜR WC	58
	EPA	ESPIGA PARA PANEL AISLANTE EPA EPA ANCHOR FOR INSULATING PANELS FIXING IN CONCRETE CHEVILLE POUR PANNEAUX D'ISOLATION SUR BÉTON EPA DÜBEL FÜR BEFESTIGUNG VON ISOLIERPLATTE AUF BETON EPA	59
	EPAM	ESPIGA PARA PANEL AISLANTE EPAM EPAM ANCHOR WITH NAIL FOR INSULATING PANELS FIXING IN CONCRETE CHEVILLE AVEC CLOU POUR PANNEAUX D'ISOLATION SUR BÉTON EPAM DÜBEL MIT NAGEL FÜR BEFESTIGUNG VON ISOLIERPLATTE AUF BETON EPAM	 59
	LU / LY	ARANDELA DE ACERO PARA PANEL AISLANTE STEEL LARGE WASHER FOR INSULATED PANELS FIXING RONDELLE EN ACIER POUR PANNEAUX D'ISOLATION SCHEIBE FÜR BEFESTIGUNG VON ISOLIERPLATTE	59

TORNILLERÍA
GENERAL FASTENERS / BOULONNERIE ET VISSERIE / ALLGEMEINE BEFESTIGUNGEN

















	7505AB	TORNILLO DIN 7505-A BICROMATADO PZ CHIPBOARD SCREW PZ YELLOW ZINC PLATED VIS À BOIS PZ BICHROMATÉ SENKKOPF-SPANPLATTENSCHRAUBE GELB VERZINKT	60-62
	7505ABT	TORNILLO DIN 7505-A AUTOPERFORANTE BICROMATADO TX MULTISCREW FLAT HEAD TX - YELLOW ZINC PLATED VIS À BOIS AUTOPERCEUSE TX BICHROMATÉ SENKKOPF-SPANPLATTENSCHRAUBE, INNENSECHSRUND, GELB VERZINKT - BOHRSCHRAUBEN	63
	MULTI+	TORNILLO DIN 7505-A AUTOPERFORANTE CINCADO PZ SELF-DRILLING CHIPBOARD SCREW PZ ZINC PLATED VIS À BOIS AUTOPERCEUSE EN ACIER ZINGUÉ SENKKOPF-SPANPLATTENSCHRAUBE VERZINKT - BOHRSCHRAUBEN	64
	7505BZ	TORNILLO DIN 7505-B CINCADO PZ CHIPBOARD SCREW PZ ZINC PLATED VIS À BOIS PZ EN ACIER ZINGUÉ SENKKOPF-SPANPLATTENSCHRAUBE VERZINKT	NUEVO NEW 64
	571Z	TORNILLO BARRAQUERO DIN 571 CINCADO HEXAGONAL HEAD WOOD SCREW ZINC PLATED TIRAFOND À VISSER AVEC TÊTE HEXAGONALE EN ACIER ZINGUÉ SECHSKANT-HOLZSCHRAUBE VERZINKT	65-66
	EDRT	ESPÁRRAGO DOBLE ROSCA CINCADO TX ZINC PLATED DOWEL SCREW WITH TX HEAD VIS COMBI AVEC SECTION HEXAGONALE TX EN ACIER ZINGUÉ VERZINKTE SCHRAUBE MIT DOPPELTEM GEWINDE	67
	DRZ	TORNILLO ABRAZADERA DOBLE ROSCA CINCADO DOUBLE THREADED SCREW ZINC PLATED VIS POUR COLLIER ET CRAMPON ZINGUÉ VERZINKTE VERBINDUNGSSCHRAUBE MIT DOPPELTEM GEWINDE	67
	TITMZ	TORNILLO INVIOLEABLE ROSCA MADERA CINCADO TX MUSHROOM HEAD GLOBE-RECESS WOOD SCREW ZINC PLATED VIS À BOIS TÊTE BOMBÉE À SIX LOBES EN ACIER ZINGUÉ RUNDKOPF-HOLZSCHRAUBE MIT INNERSECHSRUND VERZINKT	68

TORNILLERÍA

GENERAL FASTENERS / BOULONNERIE ET VISSERIE / ALLGEMEINE BEFESTIGUNGEN

	TMMN	TORNILLO ROSCA MADERA CINCADO NEGRO TX MUSH-ROOM HEAD GLOBE-RECESS WOOD SCREW BLACK ZINC PLATED VIS À BOIS TÊTE BOMBÉE À SIX LOBES EN ACIER ZINGUÉ NOIR RUNDKOPF-HOLZSCHRAUBE MIT INNERSECHSRUND SCHWARZ VERZINKT	68
	PLADUR	TORNILLO FOSFATADO PARA CARTÓN-YESO PHOSPHATED DRY WALL SCREW FOR PLASTERBOARD VIS POUR PLAQUES DE PLÂTRE EN ACIER PHOSPHATÉ PHOSPHATIERTER SCHWARZE TROPETEKOPFSCHRAUBE FÜR GIPSKARTON	69
	PLADURA	TLLO. AUTOOPERFORANTE FOSFATADO PARA CARTÓN-YESO SELF-DRILLING PHOSPHATED DRY WALL SCREW FOR PLASTERBOARD VIS AUTOPERCEUSE POUR PLAQUES DE PLÂTRE EN ACIER PHOSPHATÉ PHOSPHATIERTER SCHWARZE TROPETEKOPFSCHRAUBE FÜR GIPSKARTON	NUEVO NEW 69
	CCZ	CÁNCAMO CERRADO CINCADO EYE WOOD SCREW ZINC PLATED VIS OEILLET À BOIS EN ACIER ZINGUÉ HOLZ-AUGENSCHRAUBE VERZINKT	70
	CAZ	CÁNCAMO ABIERTO CINCADO HOOK WOOD SCREW ZINC PLATED VIS CROCHER ROND À BOIS EN ACIER ZINGUÉ HOLZSCHRAUBE MIT RUNDHAKEN VERZINKT	71
	AZ	ALCAYATA ROSCADA CINCADA "L" SHAPED WOOD SCREW ZINC PLATED VIS CROCHET DROIT À BOIS EN ACIER ZINGUÉ HOLZSCHRAUBE HAKEN VERZINKT	72
	94Z	PASADOR DIN 94 CINCADO ZINC PLATED SPLIT PINS DIN 94 GOUPILLE DIN 94 EN ACIER ZINGUÉ SPUNTE DIN 94 VERZINKT	73
	PRZ	PASADOR EN "R" CINCADO ZINC PLATED SPRING COOTERS FOR BOLT GOUPILLE BETA EN ACIER ZINGUÉ BETA-STIFT VERZINKT	74
	PAZ	PASADOR ANILLA CINCADO ZINC PLATED LINC PINS GOUPILLE ANNEUX EN ACIER ZINGUÉ KLAPPSTECKER VERZINKT	75
	PRD	PASADOR EN "R" DOBLE VUELTA CINCADO ZINC PLATED SPRING COOTERS DOUBLE LOOP FOR BOLT GOUPILLE BETA TORDU EN ACIER ZINGUÉ BETA-STIFT DOPPEL-LOOP VERZINKT	76
	PAC	PASADOR ANILLA CENTRO EJE - MEDIA LUNA CINCADO ZINC PLATED PIPE LINC PINS GOUPILLE POUR TUBES EN ACIER ZINGUÉ ROHRKLAPPSTECKER VERZINKT	76
	ESEZ	GANCHO EN "S" CINCADO ZINC PLATED "S" HOOK CROCHETS "S" EN ACIER ZINGUÉ "S" HAKEN VERZINKT	76
	HCZ / HCE HCA2	HEMBRILLAS CERRADAS ROSCA MÉTRICA EYE THREADS PITON VIS À OEILLET AUGENSCHRAUBE	77
	HAZ / HAE HAA2	HEMBRILLAS ABIERTAS ROSCA MÉTRICA HOOK THREADS PITON VIS À OEILLET OUVERT RUNDHAKEN	77
	9128Z	TORNILLO DIN 912 8.8 CINCADO CYLINDER HEAD HEXAGONAL RECESS SCREW DIN 912 8.8 - ZINC PLATED VIS FILETAGE MÉTRIQUE TÊTE CYLINDRIQUE À SIX PANS CREUX DIN 912 8.8 - ZINGUÉ ZYLINDERSCHRAUBE MIT INNENSECHSKANT DIN 912 8.8 - VERZINKT	78
	79911Z	TORNILLO DIN 7991 10.9 CINCADO HEXAGON SOCKET COUNTERSUNK HEAD SCREW 10.9 ZINC PLATED VIS FILETAGE MÉTRIQUE DIN 7991 10.9 EN ACIER ZINGUÉ SENKKOPFSCHRAUBE MIT INNENSECHSKANT DIN 7991 10.9 - VERZINKT	78
	9128TZ	TORNILLO DIN 912 8.8 CINCADO TX CYLINDER HEAD 6-LOBE RECESS SCREW DIN 912 8.8 - ZINC PLATED VIS FILETAGE MÉTRIQUE TÊTE CYLINDRIQUE TX DIN 912 8.8 EN ACIER ZINGUÉ ZYLINDERSCHRAUBE MIT INNENSECHSRUND DIN 912 8.8 - VERZINKT	79
	79918TZ	TORNILLO DIN 7991 8.8 TX CINCADO COUNTERSUNK HEAD 6-LOBE RECESS SCREW DIN 7991 8.8 - ZINC PLATED VIS FILETAGE MÉTRIQUE TÊTE FRAISÉE TX DIN 7991 8.8 EN ACIER ZINGUÉ SENKKOPFSCHRAUBE MIT INNENSECHSRUND DIN 7991 8.8 - VERZINKT	79
	6921Z	TLLO. CON VALONA DIN 6921 8.8 GRAFILADO CINCADO HEX. FLANGED WASHER HEAD WITH SERRATION SCREW DIN 6921 8.8 ZINC PLATED VIS TÊTE HEXAGONALE DIN 6921 8.8 EN ACIER ZINGUÉ SECHSKANTSCHRAUBE MIT GERÄNDELTER UNTEREGSCHEIBE DIN 6921 8.8 VERZINKT	79
	7380Z	TORNILLO ISO 7380 CINCADO HEXAGON SOCKET PAN-HEAD SCREW ISO 7380 ZINC PLATED VIS FILETAGE MÉTRIQUE TÊTE BOMBÉE À SIX PANS CREUX ISO 7380 EN ACIER ZINGUÉ / RUNDKOPFSCHRAUBE MIT INNENSECHSKANT ISO 7380 - VERZINKT	80
	7380TZ	TORNILLO ISO 7380 CINCADO TX 6-LOBE RECESS PAN-HEAD SCREW ISO 7380 ZINC PLATED VIS FILETAGE MÉTRIQUE TÊTE BOMBÉE TX ISO 7380 EN ACIER ZINGUÉ RUNDKOPFSCHRAUBE MIT INNENSECHSRUND ISO 7380 - VERZINKT	80
	7380AZ	TORNILLO CON VALONA ISO 7380-2 CINCADO HEXAGON SOCKET PAN-HEAD WITH WASHER SCREW ISO 7380-2 ZINC PLATED VIS F. MÉTRIQUE TÊTE BOMBÉE AVEC RONDELLE ISO 7380-2 EN ACIER ZINGUÉ RUNDKOPFSCHRAUBE MIT SCHEIBEN UND INNENSECHSKANT ISO 7380-2 - VERZINKT	80

TORNILLERÍA
GENERAL FASTENERS / BOULONNERIE ET VISSERIE / ALLGEMEINE BEFESTIGUNGEN

	6034Z	TORNILLO DIN 603 + TUERCA DIN 934 CINCADO MUSH-ROOM HEAD SQUARE NECK BOLT DIN 603 WITH NUT DIN 934 - ZINC PLATED BOULON TÊTE BOMBÉE TIGE À COLLET CARRÉ DIN 603 AVEC ECROU EN ACIER ZINGUÉ FLACHRUNDKOPF-BOLZENSCHAFT MIT VIERKANT DIN 603 UND MUTTER - VERZINKT	81
	9338Z	TORNILLO DIN 933 8.8 CINCADO HEXAGONAL HEAD SCREW DIN 933 8.8 GRADE - ZINC PLATED VIS TÊTE HEXAGONALE DIN 933 CLASSE 8.8 EN ACIER ZINGUÉ SECHSKANTSCHRAUBE DIN 933 KLASSE 8.8 - VERZINKT	82-83
	9318Z	TORNILLO DIN 931 8.8 CINCADO HEXAGONAL HEAD SCREW DIN 931 8.8 GRADE - ZINC PLATED VIS TÊTE HEXAGONALE DIN 931 CLASSE 8.8 EN ACIER ZINGUÉ SECHSKANTSCHRAUBE DIN 931 KLASSE 8.8 - VERZINKT	83
	84Z	TORNILLO DIN 84 CINCADO SCREW DIN 84 ZINC PLATED VIS FILETAGE MÉTRIQUE DIN 84 EN ACIER ZINGUÉ ZYLINDERKOPFSCHRAUBE DIN 84 VERZINKT	84
	7985Z	TORNILLO DIN 7985 CINCADO SCREW DIN 7985 ZINC PLATED VIS FILETAGE MÉTRIQUE DIN 7985 EN ACIER ZINGUÉ ZYLINDERKOPFSCHRAUBE DIN 7985 VERZINKT	85
	965Z	TORNILLO DIN 965 CINCADO SCREW DIN 965 ZINC PLATED VIS FILETAGE MÉTRIQUE DIN 965 EN ACIER ZINGUÉ ZYLINDERKOPFSCHRAUBE DIN 965 VERZINKT	86
	B963Z	TORNILLO DIN 963 CINCADO + DIN 934 Y DIN 125 ZINC PLATED SCREW DIN 963 WITH NUT & WASHER VIS FILETAGE MÉTRIQUE DIN 963 AVEC ECROU ET RONDELLE EN ACIER ZINGUÉ SECHKOPFSCHRAUBE DIN 963 MIT MUTTER UND SCHEIBEN - VERZINKT	87
	TIRADOR	TORNILLO TIRADOR COMBI CINCADO PZ COMBI RECESS PAN WASHER HEAD SCREW ZINC PLATED VIS AVEC RONDELLE INTÉGRÉE EMPREINTE PZ COMBI EN ACIER ZINGUÉ LINSENKOPFSCHRAUBE VERZINKT MIT KREUZSCHLITZ PZ COMBI	87
	TTC445	TORNILLO TIRADOR CORTABLE COMBI CINCADO PZ COMBI RECESS BRAKE-OFF PAN WASHER HEAD SCREW ZINC PLATED VIS AVEC RONDELLE INTÉGRÉE PZ COMBI EN ACIER ZINGUÉ LINSENKOPFSCHRAUBE VERZINKT MIT UNTEREGGSCHIBE UND KREUZSCHLITZ PZ COMBI	87
	BH933Z	TLLO. DIN 933 8.8 CINCADO + DIN 934 Y DIN 125 ZINC PLATED SCREW DIN 933 WITH NUT & WASHER VIS DIN 933 AVEC ECROU ET RONDELLE EN ACIER ZINGUÉ SECHKANTSCHRAUBE DIN 933 MIT MUTTER UND SCHEIBEN - VERZINKT	88
	BH84Z	TLLO. DIN 84 CINCADO + DIN 934 Y DIN 125 ZINC PLATED SCREW DIN 84 WITH NUT & WASHER VIS DIN 84 AVEC ECROU ET RONDELLE EN ACIER ZINGUÉ SECHKANTSCHRAUBE DIN 84 MIT MUTTER UND SCHEIBEN	88
	AZ	ARANDELA DE CARROCERO CINCADA ZINC PLATED WIDE WASHER RONDELLE DE CARROSSERIE EN ACIER ZINGUÉ KAROSSERIESCHEIBEN VERZINKT	89
	934Z/985Z/6923Z/1587Z/315Z 975Z/9759Z/125Z/9021Z/127Z	VARILLAS ROSCADAS, TUERCAS Y ARANDELAS THREADED RODS, NUTS AND WASHERS TIGES FILETÉES, ÉCROUS ET RONDELLES GEWINDESTANGEN, MUTTERN UND SCHEIBEN	89-91
	7504K	TORNILLO AUTOOPERFORANTE DIN 7504-K CINCADO HEX. FLAT WASHER HEAD SELF DRILLING SCREW WITH UNDERCUT DIN 7504-K ZINC PLATED VIS AUTOOPERCEUSE TÊTE HEX. À RONDELLE INTÉGRÉE DIN 7504-K EN ACIER ZINGUÉ SECHKANT-BOHRSCHEIBE MIT INTEGRIERTER UNTERLEGGSCHIBE DIN 7504-K VERZINKT	92
	7504KA	TORNILLO AUTOOPERFORANTE DIN 7504-K CINCADO + ARANDELA EPDM HEX. HEAD SELF DRILLING SCREW DIN 7504-K ZINC PLATED WITH EPDM WASHER VIS AUTOOPERCEUSE TÊTE HEX. DIN 7504-K EN ACIER ZINGUÉ AVEC RONDELLE VULCANISÉ SECHKANT-BOHRSCHEIBE DIN 7504-K VERZINKT MIT SCHEIBE EPDM	93
	7504KR	TLLO. AUTOOPERFORANTE DIN 7504-K P/REDUCIDA CINCADO ZINC PLATED SELF DRILLING SCREW WITH REDUCED POINT DIN 7504-K VIS AUTOOPERCEUSE AVEC POINTE RÉDUITE DIN 7504-K EN ACIER ZINGUÉ SECHKANT-BOHRSCHEIBE MIT REDUZIERTEM BOHRSPITZE DIN 7504-K VERZINKT	NUEVO NEW 94
	7504KRA	TLLO. AUTOP. DIN 7504-K P/REDUCIDA CINCADO + EPDM Ø16 ZINC PLATED SELF DRILLING SCREW WITH RED. POINT DIN 7504-K + EPDM Ø16 VIS AUTOOPERCEUSE AVEC POINTE RÉD. DIN 7504-K EN ACIER ZINGUÉ + EPDM Ø16 BOHRSCHEIBE MIT REDUZIERTEM BOHRSPITZE DIN 7504-K VERZINKT + EPDM Ø16	NUEVO NEW 94
	7504KBI	TLLO. DIN 7504-K BIMETAL P. N°3 - INOX. A2 / ACERO CARBONO BIMETAL SELF DRILLING SCREW POINT 3 VIS AUTOOPERCEUSE POINTE 3 BI-MÉTAL BIMETALL SECHKANT-BOHRSCHEIBE SPITZE 3	NUEVO NEW 94
	FSTZ	TLLO. AUTOOPERFORANTE CABEZA PLANA CINCADO SELF DRILLING SCREW FLAT PAN HEAD ZINC PLATED VIS AUTOOPERCEUSE TÊTE BOMBÉE PLATE EN ACIER ZINGUÉ FLACHKOPF-BOHRSCHEIBE KREUZSCHLITZ VERZINKT	95
	FSTP	TLLO. AUTOOPERFORANTE CABEZA EXTRAPLANA CINCADO SELF DRILLING SCREW FLAT PAN HEAD ZINC PLATED VIS AUTOOPERCEUSE TÊTE BOMBÉE PLATE EN ACIER ZINGUÉ FLACHKOPF-BOHRSCHEIBE KREUZSCHLITZ VERZINKT	NUEVO NEW 95
	FSTPN	TLLO. AUTOOPERFORANTE C/EXTRAPLANA CINCADO NEGRO SELF DRILLING SCREW FLAT PAN HEAD BLACK ZINC PLATED VIS AUTOOPERCEUSE TÊTE BOMBÉE PLATE EN ACIER ZINGUÉ NOIR FLACHKOPF-BOHRSCHEIBE KREUZSCHLITZ SCHWARZ VERZINKT	NUEVO NEW 95
	FSTPLB	TLLO. AUTOOPERFORANTE C/EXTRAPLANA LACADO BLANCO SELF DRILLING SCREW FLAT PAN HEAD WHITE LACQUERED VIS AUTOOPERCEUSE TÊTE BOMBÉE PLATE EN ACIER LAQUÉ BLANC FLACHKOPF-BOHRSCHEIBE KREUZSCHLITZ SCHWARZ WEISS GESTRICHENEN	NUEVO NEW 95



















TORNILLERÍA

GENERAL FASTENERS / BOULONNERIE ET VISSERIE / ALLGEMEINE BEFESTIGUNGEN

	7504N	TORNILLO AUTOPERFORANTE DIN 7504-N CINCADO PAN HEAD SELF DRILLING SCREW DIN 7504-N ZINC PLATED VIS AUTOPERCEUSE TÊTE CYLINDRIQUE DIN 7504-N EN ACIER ZINGUÉ ZYLINDERKOPF-BOHRSCHEIBE DIN 7504-N VERZINKT	96
	7504P	TORNILLO AUTOPERFORANTE DIN 7504-P CINCADO FLAT CSK HEAD SELF DRILLING SCREW DIN 7504-P ZINC PLATED VIS AUTOPERCEUSE TÊTE FRAISÉE PLATE DIN 7504-P EN ACIER ZINGUÉ SENKKOPF-BOHRSCHEIBE DIN 7504-P VERZINKT	97
	7504NT	TORNILLO AUTOPERFORANTE DIN 7504-N CINCADO TX PAN HEAD 6-LOBE RECESS SELF DRILL. SCREW DIN 7504-N TX ZINC PLATED VIS AUTOP. EMPREINTE À SIX LOBES DIN 7504-N TX EN ACIER ZINGUÉ ZYLINDERKOPF-BOHRSCHEIBE, EINSATZGEHÄRTET, DIN 7504-N TX VERZINKT	99
	7504PT	TORNILLO AUTOPERFORANTE DIN 7504-P CINCADO TX SELF DRILLING SCREW RECESS SELF DRILLING SCREW DIN 7504-P TX ZINC PLATED VIS AUTOP. EMPREINTE À SIX LOBES DIN 7504-P TX EN ACIER ZINGUÉ SENKKOPF-BOHRSCHEIBE INNENSECHSRUND, DIN 7504-P TX VERZINKT	99
	7504PAT	TORNILLO DIN 7504-P CINCADO TX CON ALAS FLAT CSK. HEAD TX SELF DRILLING SCREW WITH WINGS DIN 7504-P TX ZINC PLATED VIS AUTOP. EMPREINTE À SIX LOBES AVEC AILETTES DIN 7504-P TX EN ACIER ZINGUÉ SENKKOPF-BOHRSCHEIBE MIT FLÜGEL INNENSECHSRUND, DIN 7504-P TX VERZINKT	NUEVO NEW 100
	TPSA3	TORNILLO PANEL SANDWICH PUNTA BROCA N°3 + EPDM Ø16 SELF DRILLING SCREW POINT N°3 FOR SANDWICH PANELS + EPDM Ø16 VIS AUTOPERCEUSE POINTE N°3 POUR PANNEAU SANDWICH + EPDM Ø16 SECHSKANT-BOHRSCHEIBE SPITZE N°3 + EPDM Ø16	100
	TV	TLLO. VIGA AUTOPERFORANTE PUNTA BROCA N°5 CINCADO SELF DRILLING SCREW POINT N°5 ZINC PLATED VIS AUTOPERCEUSE POINTE N°5 EN ACIER ZINGUÉ SECHSKANT-BOHRSCHEIBE SPITZE N°5	101
	TVA	TLLO. VIGA AUTOPERFORANTE PUNTA BROCA N°5 CINCADO + EPDM SELF DRILLING SCREW POINT N°5 ZINC PLATED + EPDM WASHER VIS AUTOPERCEUSE POINTE N°5 EN ACIER ZINGUÉ + RONDELLE EPDM SECHSKANT-BOHRSCHEIBE SPITZE N°5 + SCHEIBE EPDM	101
	HO76	TLLO. AUTORROSCANTE DE ACERO CEMENTADO HORMIGÓN CONCRETE SELF-TAPPING SCREW - HARDENED STEEL VIS AUTOTARAUDEUSE EN ACIER CÉMENTE POUR BÉTON BETONBLECHSCHRAUBE EINSATZGEHÄRTET	NUEVO NEW 102
	HO76A	TLLO. AUTOR. DE ACERO CEMENTADO HORMIGÓN + EPDM Ø16 CONCRETE SELF-TAPPING SCREW WITH EPDM WASHER - HARDENED STEEL VIS AUTOTARAUDEUSE EN ACIER CÉMENTE POUR BÉTON AVEC RONDELLE EPDM BETONBLECHSCHRAUBE EINSATZGEHÄRTET MIT SCHEIBE EPDM	NUEVO NEW 102
	EPDM/EPDMA/EPDMA2/DVGR DVMA/DVOX/DVVE/DVAZ/DVAL	ARANDELA EPDM EPDM WASHER RONDELLE AVEC GUARNITURE EN EPDM D'ÉTANCHÉITÉ SCHEIBE MIT EPDM DICHTUNG	103
	AR	ARANDELA ROMBO CINCADA POLIETILENO ZINC PLATED STEEL RHOMBOIDAL GASKET WITH PE FOAM RONDELLE RHOMBOÏDALE EN ACIER ZINGUÉ AVEC GUARNITURE EN POLYÉTHYLÈNE VERZINKTE RHOMBUSFÖRMIGE SCHEIBE MIT SCHAUMSTOFFDICHTUNG	103
	ANP/ANPA2/ANPA/ANPG ANPM/ANPO/AMPT	ARANDELA EPDM PARAGUAS EPDM UMBRELLA GASKET ASSEMBLED WITH METAL WASHER RONDELLE EN EPDM AVEC RONDELLE MÉTALLIQUE LINSSENSCHEIBE AUS EPDM MIT STAHLSCHEIBE MONTIERT	104
	AEZN/AEGR/AEMA/AEOX/AEVE AEAZ/AEFU/AEBL/AEAN	ARANDELA GRECADA ACERO-POLIETILENO METAL CAP FOR ROOFING WITH POLYETHYLENE SEALING GASKET CAVALIER AVEC GUARNITURE EN POLYÉTHYLÈNE EXPANSÉ KALOTTE MIT SCHAUMSTOFFDICHTUNG	104
	TEQ	TAPÓN ENVOLVENTE HEXAGONAL HEXAGONAL PLASTIC CUP CAPUCHON EN PASTIQUE HEXAGONALE SECHSKANTKAPPE AUS PLASTIK	105
	TAPONN/TAPONG TAPONB	TAPÓN DE PLÁSTICO PARA TUERCAS Y TLLOS. HEXAGONALES HEXAG CUP CAPUCHON EN PASTIQUE KAPPE AUS PLASTIK	105
	POLICAR	ARANDELA DE NYLON CON TAPÓN Y JUNTA DE ESTANGUEIDAD NYLON WASHER WITH CAP AND PE FOAM SEALING GASKET RONDELLE AVEC CAPUCHON ET GUARNITURE EN POLYÉTHYLÈNE EXPANSÉ NYLONSCHIBE MIT KAPPE UND SCHAUMSTOFFDICHTUNG	105
	7981Z	TORNILLO DIN 7981 CINCADO PAN HEAD SCREW DIN 7981 ZINC PLATED VIS À TOLE TÊTE CYLINDRIQUE DIN 7981 EN ACIER ZINGUÉ ZYLINDERKOPF-BLECHSCHRAUBE DIN 7981 VERZINKT	106
	7982Z	TORNILLO DIN 7982 CINCADO FLAT CSK HEAD SCREW DIN 7982 ZINC PLATED VIS À TOLE TÊTE FRAISÉE DIN 7982 EN ACIER ZINGUÉ SENKKOPF-BLECHSCHRAUBE DIN 7982 VERZINKT	107
	TCMZ/TCLZ	TUERCAS CINCADAS PARA MADERA ZINC PLATED WOOD NUTS ÉCROUS EN ACIER ZINGUÉ POUR BOIS MUTTER VERZINKT FÜR HOLZ	108
	MAGA	MALETÍN SURTIDO HOGAR ASSORTMENT BRIEFCASE HOME MALLETTE ASSORTIMENT FOYER HANDKOFFER SORTIERT ZUHAUSE	108
	M471 / M472 M1481	MALETINES DIN 471-E / 472-I / DIN 1481 DIN 471-E / DIN 472-I / DIN 1481 CASE MALLETTE DE DIN 471-E / DIN 472-I / DIN 1481 DIN 471-E / DIN 472-I / DIN 1481 KOFFER	109

TORNILLERÍA INOXIDABLE

STAINLESS STEEL FASTENERS / BOULONNERIE ET VISSERIE EN ACIER INOX. / ALLGEMEINE BEFESTIGUNGEN AUS EDELSTAHL

	7505AA2	TORNILLO DIN 7505-A INOXIDABLE A-2 PZ CHIPBOARD SCREW PZ STAINLESS STEEL AISI 304 VIS À BOIS PZ EN ACIER INOX A-2 SENNKOPF-SPANPLATTENSCHRAUBE - EDELSTAHL A-2	110
	571A2	TORNILLO BARRAQUERO DIN 571 INOXIDABLE A-2 HEXAGON WOOD SCREW - STAINLESS STEEL AISI 304 TIRAFOND À VISSER AVEC TÊTE HEXAGONALE EN ACIER INOX. A-2 SECHSKANT-HOLZSCHRAUBE - EDELSTAHL A-2	111
	DRA2	TORNILLO ABRAZADERA DOBLE ROSCA INOXIDABLE A-2 DOUBLE THREADED SCREW STAINLESS STEEL AISI 304 VIS POUR COLLIER ET CRAMPON EN ACIER INOX. A-2 EDELSTAHL A-2 VERBINDUNGSSCHRAUBE MIT DOPPELTEM GEWINDE	111
	EDRA2	ESPÁRRAGO DOBLE ROSCA INOXIDABLE A-2 STAINLESS STEEL AISI 304 DOWEL THREAD SCREW VIS COMBI AVEC SECTION HEXAGONAL EN ACIER INOX. A-2 SCHRAUBE MIT DOPPELTEM GEWINDE - EDELSTAHL A-2	NUEVO NEW 112
	CCA2	CÁNCAMO CERRADO INOXIDABLE A-2 STAINLESS STEEL AISI 304 EYE WOOD SCREW VIS OUILLET À BOIS EN ACIER INOX. A-2 HOLZ-AUGENSCHRAUBE - EDELSTAHL A-2	NUEVO NEW 112
	CAA2	CÁNCAMO ABIERTO INOXIDABLE A-2 STAINLESS STEEL AISI 304 HOOK WOOD SCREW VIS CROCHER ROND À BOIS EN ACIER INOX. A-2 HOLZSCHRAUBE MIT RUNDHAKEN - EDELSTAHL A-2	NUEVO NEW 112
	912A2	TORNILLO DIN 912 INOXIDABLE A-2 CYLINDER HEAD HEXAGONAL RECESS SCREW DIN 912 STAINLESS STEEL AISI 304 VIS FILETAGE MÉTRIQUE TÊTE CYLINDRIQUE À SIX PANS CREUX DIN 912 EN ACIER INOX. A-2 ZYLINDERSCHRAUBE MIT INNENSECHSKANT DIN 912 - EDELSTAHL A-2	113
	933A2	TORNILLO DIN 933 INOXIDABLE A-2 HEXAGON HEAD SCREW DIN 933 - STAINLESS STEEL AISI 304 VIS TÊTE HEXAGONALE DIN 933 EN ACIER INOX. A-2 SECHSKANTSCHRAUBE DIN 933 - EDELSTAHL A-2	114-115
	931A2	TORNILLO DIN 931 INOXIDABLE A-2 HEXAGON HEAD SCREW DIN 931 - STAINLESS STEEL AISI 304 VIS TÊTE HEXAGONALE DIN 931 EN ACIER INOX. A-2 SECHSKANTSCHRAUBE DIN 931 - EDELSTAHL A-2	115
	7380A2	TORNILLO ISO 7380 INOXIDABLE A-2 HEXAGON SOCKET PAN-HEAD SCREW ISO 7380 STAINLESS STEEL AISI 304 VIS FILETAGE MÉTRIQUE TÊTE BOMBÉE À SIX PANS CREUX ISO 7380 EN ACIER INOX. A-2 RUNDKOPFSCHRAUBE MIT INNENSECHSKANT ISO 7380 - EDELSTAHL A-2	116
	7991A2	TORNILLO DIN 7991 INOXIDABLE A-2 HEXAGON SOCKET COUNTERSUNK HEAD SCREW STAINLESS STEEL AISI 304 VIS FILETAGE MÉTRIQUE DIN 7991 EN ACIER INOX. A-2 SENNKOPFSCHRAUBE MIT INNENSECHSKANT DIN 7991 - EDELSTAHL A-2	116
	603A2	TORNILLO DIN 603 INOXIDABLE A-2 MUSHROOM HEAD SQUARE NECK BOLT DIN 603 - STAINLESS STEEL AISI 304 BOULON TÊTE BOMBÉE TIGE À COLLET CARRÉ DIN 603 EN ACIER INOX. A-2 FLACHRUNDKOPF-BOLZENSCHAFT MIT VIERKANT DIN 603 - EDELSTAHL A-2	117
	7985A2	TORNILLO DIN 7985 INOXIDABLE A-2 SCREW DIN 7985 STAINLESS STEEL AISI 304 VIS FILETAGE MÉTRIQUE DIN 7985 EN ACIER INOX. A-2 ZYLINDERKOPFSCHRAUBE DIN 7985 - EDELSTAHL A-2	117
	84A2	TORNILLO DIN 84 INOXIDABLE A-2 SCREW DIN 84 STAINLESS STEEL AISI 304 VIS FILETAGE MÉTRIQUE DIN 84 EN ACIER INOX. A-2 ZYLINDERKOPFSCHRAUBE DIN 84 - EDELSTAHL A-2	118
	965A2	TORNILLO DIN 965 INOXIDABLE A-2 SCREW DIN 965 STAINLESS STEEL AISI 304 VIS FILETAGE MÉTRIQUE DIN 965 EN ACIER INOX. A-2 SENNKOPFSCHRAUBE DIN 965 - EDELSTAHL A-2	119
	963A2	TORNILLO DIN 963 INOXIDABLE A-2 SCREW DIN 963 STAINLESS STEEL AISI 304 VIS FILETAGE MÉTRIQUE DIN 963 EN ACIER INOX. A-2 SENNKOPFSCHRAUBE DIN 963 - EDELSTAHL A-2	119
	975A2/934A2/985A2/6923A2/1587A2 315A2/125A2/9021A2/127A2	VARILLAS, TUERCAS Y ARANDELAS INOX. A-2 THREADED RODS, NUTS AND WASHERS - SS. AISI 304 TIGES FILETÉES, ÉCROUS ET RONDELLES - INOX. A-2 GEWINDESTANGEN, MUTTERN UND SCHEIBEN - EDELSTAHL A-2	120-122
	7981A2	TORNILLO DIN 7981 INOXIDABLE A-2 PAN HEAD SCREW DIN 7981 STAINLESS STEEL AISI 304 VIS À TOLE TÊTE CYLINDRIQUE DIN 7981 EN ACIER INOX. A-2 ZYLINDERKOPF-BLECHSCHRAUBE DIN 7981 - EDELSTAHL A-2	123
	7982A2	TORNILLO DIN 7982 INOXIDABLE A-2 FLAT CSK HEAD SCREW DIN 7982 STAINLESS STEEL AISI 304 VIS À TOLE TÊTE FRAISÉE DIN 7982 EN ACIER INOX. A-2 SENNKOPF-BLECHSCHRAUBE DIN 7982 - EDELSTAHL A-2	124

INOXIDABLE A4
STAINLESS STEEL AISI 316
**LUSAN SUMINISTRA TORNILLERÍA INOXIDABLE A4 BAJO PEDIDO
 CON LA MAYOR EFICACIA Y GARANTIZANDO LA MÁXIMA CALIDAD**
**LUSAN SUPPLIES STAINLESS STEEL AISI 316 SCREWS ON REQUEST WITH
 THE MOST EFFICIENCY AND GUARANTEEING THE MAXIMUM QUALITY**

REMACHES
BLIND RIVETS / RIVETS / BLINDNIETE

	RESA	REMACHE TUBULAR DIN 7337 - ALUMINIO / ACERO ALUMINIUM / STEEL BLIND RIVET DIN 7337 RIVET TUBULAIRE DIN 7337 EN ALUMINIUM / ACIER BLINDNIETE DIN 7337 AUS ALUMINIUM / STAHL	126
	RESAA	REMACHE TUBULAR DIN 7337 CABEZA ANCHA - ALUMINIO / ACERO ALUMINIUM / STEEL WIDE HEAD BLIND RIVET DIN 7337 RIVET TUBULAIRE TÊTE LARGE DIN 7337 EN ALUMINIUM / ACIER BREITENKOPF-BLINDNIETE DIN 7337 AUS ALUMINIUM / STAHL	127
	RA	REMACHE TUBULAR DIN 7337 - ACERO / ACERO STEEL / STEEL BLIND RIVET DIN 7337 RIVET TUBULAIRE DIN 7337 EN ACIER / ACIER BLINDNIETE DIN 7337 AUS STAHL / STAHL	128
	RESA2	REMACHE TUBULAR DIN 7337 - INOX A-2 / INOX A-2 STAINLESS STEEL AISI 304 / STAINLESS STEEL AISI 304 BLIND RIVET DIN 7337 RIVET TUBULAIRE DIN 7337 EN ACIER INOX A-2 / ACIER INOX A-2 BLINDNIETE DIN 7337 AUS EDELSTAHL A-2 / EDELSTAHL A-2	128
	RESAF	REMACHE TUBULAR FLOR - ALUMINIO / ACERO ALUMINIUM / STEEL PEEL DOMED HEAD BLIND RIVET RIVET TUBULAIRE ECLATE EN ALUMINIUM / ACIER SCHÄLEN GEWÖLBTENKOPF-BLINDNIETE AUS ALUMINIUM / STAHL	129
	RFA	REMACHE TUBULAR FLOR CABEZA ANCHA - ALUMINIO / ACERO ALUMINIUM / STEEL PEEL WIDE HEAD BLIND RIVET RIVET TUBULAIRE ECLATE TÊTE LARGE EN ALUMINIUM / ACIER SCHÄLEN GEWÖLBTENBREITENKOPF-BLINDNIETE AUS ALUMINIUM / STAHL	129
	RESN / RESAB	REMACHE T. DIN 7337 LACADO BLANCO Y NEGRO - ALUMINIO / ACERO BLACK AND WHITE ALUMINIUM / STEEL BLIND RIVET DIN 7337 RIVET TUBULAIRE DIN 7337 EN ALUMINIUM / ACIER BLANC ER NOIR BLINDNIETE DIN 7337 AUS ALUMINIUM / STAHL VERZINKT SCHWARZ UND WEISS	130
	RAM	REMACHE TUBULAR CABEZA MULTIGRIP - ALUMINIO / ACERO ALUMINIUM / STEEL MULTIGRIP HEAD BLIND RIVET RIVET TUBULAIRE TÊTE MULTIGRIP EN ALUMINIUM / ACIER MULTIGRIP BLINDNIETE AUS ALUMINIUM / STAHL	130
	RAC	REMACHE T. DIN 7337 CABEZA AVELLANADA - ALUMINIO / ACERO ALUMINIUM / STEEL COUNTERSUNK HEAD BLIND RIVET DIN 7337 RIVET TUBULAIRE TÊTE FRAISÉE DIN 7337 EN ALUMINIUM / ACIER BLINDNIETE MIT SENKKOPF DIN 7337 AUS ALUMINIUM / STAHL	131
	RAT	REMACHE TUBULAR TRÉBOL - ALUMINIO / ALUMINIO ALUMINIUM / ALUMINIUM "CLOVER" BLIND RIVET RIVET TUBULAIRE TRÉFLE EN ALUMINIUM / ALUMINIUM KLEE-BLINDNIETE AUS ALUMINIUM / ALUMINIUM	131
	RATAN	REMACHE TUBULAR TRÉBOL CABEZA ANCHA - ALUMINIO / ALUMINIO ALUMINIUM / ALUMINIUM "CLOVER" WIDE HEAD BLIND RIVET RIVET TUBULAIRE TRÉFLE TÊTE LARGE EN ALUMINIUM / ALUMINIUM BREITENKOPF KLEE-BLINDNIETE AUS ALUMINIUM / ALUMINIUM	131
	RAE	REMACHE TUBULAR ESTANCO - ALUMINIO / ACERO ALUMINIUM / STEEL SEALED HEAD BLIND RIVET RIVET TUBULAIRE ETANCHE DIN 7337 EN ALUMINIUM / ACIER VERSIEGELT-BREITENKOPF BLINDNIETE AUS ALUMINIUM / STAHL	132
	TRCB / TRCBA2	TUERCA REMACHABLE CABEZA BAJA CINCADA / INOX A-2 REDUCED HEAD BLIND RIVET NUT - ZINC PLATED / STAINLESS STEEL AISI 304 ÉCROU À SERTIR TÊTE REDUITE EN ACIER ZINGUÉ / INOX A-2 REDUZIERKOPF-BLINDNIET MUTTERN VERZINKT / EDELSTAHL A-2	132
	TRCA	TUERCA REMACHABLE CABEZA ANCHA CINCADA BLIND RIVET NUT - ZINC PLATED ÉCROU À SERTIR EN ACIER ZINGUÉ BREITENKOPF-BLINDNIET MUTTERN VERZINKT	133
	TRE	TUERCA REMACHABLE HEXAGONAL CINCADA HEXAGONAL BLIND RIVET NUTS ZINC PLATED ÉCROU À SERTIR HEXAGONAL EN ACIER ZINGUÉ SECHSKANTKOPF-BLINDNIET MUTTERN VERZINKT	133
	TRAV	TUERCA REMACHABLE CABEZA AVELLANADA CINCADA STEEL BLIND RIVET NUTS WITH FLAT COUNTERSUNK HEAD ZINC PLATED ÉCROU A SERTIR TÊTE FRAISÉE EN ACIER ZINGUÉ SENKKOPF-BLINDNIET MUTTERN VERZINKT	NUEVO NEW 133
	RME	REMACHADORA MANUAL MANUAL RIVETER RIVETER MANUEL MANUELLER-NIETMASCHINE	134
	RMR6	REMACHADORA MANUAL DE 2 BRAZOS 2 ARMS MANUAL RIVETER RIVETER MANUEL ET DEUX BRAS ZWEI-ARM-MANUELLER NIETMASCHINE	NUEVO NEW 134
	RT2B4	REMACHADORA DE TUERCAS DE 2 BRAZOS 2 ARMS MANUAL NUT RIVETER RIVETER D'ÉCROUS MANUEL ET DEUX BRAS ZWEI-ARM-MANUELLER NIETMASCHINE	134
	SRC56	REMACHADORA NEUMÁTICA PNEUMATIC RIVETER RIVETER PNEUMATIQUE MANUEL PNEUMATISCHE-NIETMASCHINE	134

ABRAZADERAS
 CLAMPS / COLLIERS / KLEMM

	ABAR	ABARCONES CON TUERCA Y ARANDELA DIN 3570 "U" BOLT WITH NUTS AND WASHERS ÉTRIERS AVEC ÉCROUS ET RONDELLES RUNDSTAHLBÜGEL MIT MUTTER UND SCHEIBEN	135
	ABL / ABP	ABRAZADERA SIN FIN WORM HOSE CLAMP COLLIERS À CRÉMAILLÈRES SCHNECKENGEWIDESCHELLEN	136-137
	ABS	ABRAZADERA SUPER HEAVY DUTY HOSE CLAMP COLLIERS À TOURILLONS GELENKBOLZENSCHELLEN	138-139
	ABR	ABRAZADERA REFORZADA - M8 + M10 PIPE CLAMP M8 + M10 CLAMP RENFORCÉ M8 + M10 VERSTÄRKT KLEMM M8 + M10	140
	ABIR	ABRAZADERA REFORZADA ISOFÓNICA - M8 + M10 RUBBER PIPE CLAMP M8 + M10 CLAMP RENFORCÉ EN CAOUTCHOUC M8 + M10 VERSTÄRKT KLEMM M8 + M10	141
	ATF	ATORNILLADOR FLEXIBLE HEXAGONAL HEXAGONAL FLEXIBLE SCREWDRIVER TOURNEVIS FLEXIBLE FLEXIBLER SCHRAUBENDREHER	NUEVO NEW 142
	A20/A10/ A10A	ABRAZADERA OREJA SECURITY EAR CLAMP COLLIER À OREILLES OHRSCHELLEN	142
	AAO/AADA	ALICATES PLIERS PINCES ZANGEN	142
	ABLI	ABRAZADERA ISOFÓNICA TIPO "L" RUBBER LINED P-CLIP COLLIER DE FIXATION AVEC CAOUTCHOUC ROHRSCHELLEN MIT GUMMIENLAGE	143
	ABTPT	ABRAZADERA PLASTIFICADA GAS CON TORNILLO PLASTIC GAS HOSE CLAMP WITH SCREW COLLIER EN PLASTIQUE GAZ AVEC VIS KUNSTSTOFFKLEMM GAS MIT SCHRAUBE	143
	GP1P/ GP2P	GRAPAS PUENTE SIMPLES S-SHAPED / D-SHAPED SADDLE CLIPS AGRAFE SIMPLE BRÜCKE CLIP FÜR ROHRLEITUNG	144
	ABTS	ABRAZADERA DE TUBO SIMPLE M-6 SIMPLE CLAMP M-6 COLLIER SERRAGE M-6 EINFACH KLEMM M-6	144
	CARRIL2 / CARRIL3 CARRILE3	CARRIL PERFORADO SLOTTED CHANNEL GOUTTIÈRE PERFORÉ LOCHSCHIENEN	145
	SCV / SCH	SOPORTES PARA CARRIL CHANNEL SUPPORT SUPPORT POUR GOUTTIÈRE UNTERSTÜTZUNG FÜR LOCHSCHIENEN	145
	PG	PUENTE GUÍA CHANNEL CLAMP COLLIER POUR GOUTTIÈRE KLEMM FÜR LOCHSCHIENEN	145
	SCP	SOPORTE PARA CARRIL PERFORADO CHANNEL SUPPORT SUPPORT POUR GOUTTIÈRE PERFORÉ UNTERSTÜTZUNG FÜR LOCHSCHIENEN	146
	CARRIL20 / CARRIL27 / CARRIL38 CARRIL41 / TCM13 / TCM38	TUERCAS PARA CARRIL PERFORADO CHANNEL NUTS ÉCROU POUR GOUTTIÈRE PERFORÉ MUTTER FÜR LOCHSCHIENEN	146
	TC27 / TC38 TC41	TORNILLO PARA CARRIL PERFORADO HAMMER HEAD BOLTS FOR CHANNELS VIS POUR GOUTTIÈRE PERFORÉ SCHRAUBEN FÜR LOCHSCHIENEN	147
	EP	ESCUADRA PERFORADA HOLE CORNER ANGLES CARRÉS POUR GOUTTIÈRE SQUARE FÜR LOCHSCHIENEN	147
	MORDAZAM/ MORDAZAP	MORDAZA PARA VIGA BEAM FIXER PINCE DE FIXATION KLEMM FÜR STAHLRÄGER	NUEVO NEW 147
	RNBG/CNBG/RCNP CCNP/RNBD/CNBD	ROLLOS DE CINTA NO PERFORADA NOT PERFORATED ROLL TAPE ROULEAU EN BANDE NON PERFORÉES	148
	BCP	CINTA PERFORADA EN BLISTER PERFORATED BAND IN BLISTER BANDE PERFORÉE EN BLISTER	148

ABRAZADERAS
CLAMPS / CLAMPS / KLEMM





















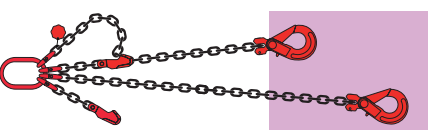

BRA	BASE RECTANGULAR PARA ABRAZADERA INOX. A-4 STAINLESS STEEL AISI 316 RECTANGULAR BASE WITH NUT BASE RECTANGULAIRE POUR CLAMP EN ACIER INOX. A-4 RECHTECKIGEN GRUND MIT MUTTER - EDELSTAHL A-4	148
BMA2	BRIDA METÁLICA CINTA INOX. A-2 CABLE TIE - STAINLESS STEEL AISI 304 COLLIER EN ACIER INOX. A-2 KABELBINDER - EDELSTAHL A-2	149
CPG/CP4 CPR	CINTA PERFORADA ONDULADA / RECTA STRAIGHT / WAVY PERFORATED ROLL TAPE RUBAN PERFORÉ ONDULÉ / DROITE GERADEN / WELLENF LOCHBAND	149

ELEMENTOS DE ELEVACIÓN
LIFTING ELEMENTS / ELEMENTS DE LEVAGE / HUBELEMENTEN



TAGZ	TENSOR ARO - GANCHO CINCADO TURNBUCKLES WITH EYE AND HOOK ZINC PLATED TENDEURS ANNEAU ET CROCHET EN ACIER ZINGUÉ SPANNSCHLÖSSE MIT HAKEN UND ÖSE VERZINKT	150
TGGZ	TENSOR GANCHO - GANCHO CINCADO TURNBUCKLES WITH TWO HOOKS ZINC PLATED TENDEURS À DEUX CROCHETS EN ACIER ZINGUÉ SPANNSCHLÖSSE MIT ZWEI HAKEN	150
TAAZ	TENSOR ARO - ARO CINCADO TURNBUCKLES WITH TWO EYES ZINC PLATED TENDEURS À DEUX ANNEAUX EN ACIER ZINGUÉ SPANNSCHLÖSSE MIT ZWEI ÖSEN	151
THHZ	TENSOR HORQUILLA - HORQUILLA CINCADO TURNBUCKLES WITH TWO JAWS ZINC PLATED TENDEURS À DEUX CHAPES EN ACIER ZINGUÉ SPANNSCHLÖSSE MIT ZWEI GABELN	151
TVVZ	TENSOR VARILLA - VARILLA DIN 1481 CINCADO TURNBUCKLES WITH STUB ENDS DIN 1481 ZINC PLATED TENDEURS À SOUDER DIN 1481 EN ACIER ZINGUÉ SPANNSCHLÖSSE MIT ZWEI ANSCHWEISSENDEN DIN 1481	151
580Z	ANILLA DE ELEVACIÓN MACHO DIN 580 CINCADA LIFTING EYE BOLT DIN 580 ZINC PLATED ANNEAU DE LEVAGE DIN 580 EN ACIER ZINGUÉ RINGSCHRAUBEN DIN 580	152
582Z	ANILLA DE ELEVACIÓN HEMBRA DIN 582 CINCADA EYE NUT DIN 582 ZINC PLATED ANNEAU DE LEVAGE DIN 582 EN ACIER ZINGUÉ RINGMUTTERN DIN 582	152
PCZ	PRENSACABLES SIMPLE CINCADO SIMPLEX WIRE ROPE CLIPS SERRE-CÂBLES SIMPLEX SIMPLEX DRAHTSEILKLEMMEN	153
PCDZ	PRENSACABLES DOBLE CINCADO DUPLEX WIRE ROPE CLIPS SERRE-CÂBLES DUPLEX DUPLEX DRAHTSEILKLEMMEN	153
6899A	GUARDACABOS DIN 6899-A CINCADO THIMBLES DIN 6899-A ZINC PLATED COSSES COEUR DIN 6899-A EN ACIER ZINGUÉ KAUSCHEN DIN 6899-A	154
6899B	GUARDACABOS DIN 6899-B GALVANIZADO THIMBLES DIN 6899-B HOT DIP GALVANIZED COSSES COEUR DIN 6899-B GALVANISÉ KAUSCHEN DIN 6899-B	154
MBZ	MOSQUETÓN BOMBERO DIN 5299 CINCADO SNAP HOOKS DIN 5299 ZINC PLATED MOUSQUETONS DIN 5299 EN ACIER ZINGUÉ KARABINERHAKEN DIN 5299	155
MBSZ	MOSQUETÓN BOMBERO CON SEGURO CINCADO SNAP HOOKS WITH SAFETY SCREW ZINC PLATED MOUSQUETONS À VIS DE SECURITE EN ACIER ZINGUÉ KARABINERHAKEN MIT SCHRAUBSICHERUNG	155
741Z	SUJETACABLES DIN 741 CINCADO WIRE ROPE CLIPS CAST IRON DIN 741 - ZINC PLATED SERRE-CÂBLES EN FONTE DIN 741 EN ACIER ZINGUÉ DRAHTSEILKLEMMEN DIN 741 VERZINKT	156
MRZ	MALLA RÁPIDA CINCADA QUICK LINKS ZINC PLATED MAILLONS RAPIDES EN ACIER ZINGUÉ KETTENNOTGLIEDER	156
MGZ	MOSQUETÓN GIRATORIO CINCADO SIMPLEX HOOKS ZINC PLATED MOUSQUETONS AVEC TOURET EN ACIER ZINGUÉ SIMPLEX-HAKEN	157
MGGN	MOSQUETÓN GANCHO GIRATORIO NIQUELADO NICKEL SNAP HOOKS MOUSQUETONS AU NICKEL KARABINERHAKEN	157

ELEMENTOS DE ELEVACIÓN
LIFTING ELEMENTS / ELEMENTS DE LEVAGE / HUBELEMENTEN

	GZ	GRILLETE GIRATORIO NIQUELADO NICKEL SWIVELS EMERILLONS AU NICKEL WIRBEL	157
	GRZ	GRILLETE RECTO CINCADO DEE SHACKLES ZINC PLATED MANILLES DROITES EN ACIER ZINGUÉ GERADE SCHÄKEL VERZINKT	158
	GRAR	GRILLETE RECTO ALTA RESISTENCIA ALLOY STEEL DEE SHACKLES WITH SCREW PIN MANILLES DROITES ACIER ALLIÉ HOCHFESTE GERADE SCHÄKEL	158
	GLZ	GRILLETE LIRA CINCADO BOW SHACKLES ZINC PLATED MANILLES LYRES EN ACIER ZINGUÉ HERZFÖRMIGE SCHÄKEL VERZINKT	159
	GLAR	GRILLETE LIRA ALTA RESISTENCIA ALLOY STEEL BOW SHACKLES WITH SCREW PIN MANILLES LYRES EN ACIER ALLIÉ HOCHFESTE HERZFÖRMIGE SCHÄKEL	159
	GRART	GRILLETE RECTO ALTA RESISTENCIA CON TORNILLO ALLOY STEEL DEE SHACKLES WITH BOLT MANILLES DROITES ACIER ALLIÉ AVEC BULLON HOCHFESTE GERADE SCHÄKEL MIT BOLZEN	160
	GLART	GRILLETE LIRA ALTA RESISTENCIA CON TORNILLO ALLOY STEEL BOW SHACKLES WITH BOLT MANILLES LYRES EN ACIER ALLIÉ AVEC BOULLON HOCHFESTE HERZFÖRMIGE SCHÄKEL MIT BOLZEN	160
	GGC	GRILLETE GIRATORIO CADENA CHAIN SWIVELS EMERILLONS CHAÎNE EINFACHES AUFHÄNGEGLIED	160
	GESA	GANCHO DE ELEVACIÓN CON SEGURO - GRADO 40 CARBON STEEL EYE HOOKS WITH LATCH CROCHETS DE LEVAGE EN ACIER CARBONE AVEC LINGUET HAKEN KOHLENSTOFFSTAHL MIT SICHERUNG	161
	GESGA	GANCHO DE ELEVACIÓN CON SEGURO GIRATORIO - GRADO 40 CARBON STEEL REVOLVING HOOKS WITH LATCH CROCHETS A EMERILLON EN ACIER CARBONE AVEC LINGUET LASTHAKEN KOHLENSTOFFSTAHL MIT SICHERUNG	161
	TGC / TGA	TRINCAJE LASHING SYSTEMS SYSTÈMES D'ARRIMAGE VERANKERUNGSSYSTEM	162
	SL	ESLINGA PLANA CON GAZAS EYESLINGAS, TWO PLYS SANGLES DE LEVAGE À BOUCLE, DEUX PLIURES ÖSEFÖRMIGE SCHLINGEN	163
	SLT	ESLINGA TUBULAR SIN FIN ROUNDSLINGS WITH SINGLE COVER SANGLES RONDES AVEC GAINÉ UNIQUE RUNDE SCHLINGEN	164
		PULPOS DE CADENA - GRADO 80 CHAIN SLINGS ELINGUE DE CHAÎNE ANSCHLAGKETTEN	165-166
	CAD	CADENA ACERO NORMA EN 818-2 - GRADO 80 STEEL CHAIN ACCORDING TO EN 818-2 - 80 DEGREE CHAÎNE ACIER SELON EN 818-2 - DEGRÉ 80 KETTE NACH EN 818-2 - GRAD 80	165-166
	TT1 / TT2 TTI	TARJETA DE IDENTIFICACIÓN - GRADO 80 IDENTIFICATION TAG PLAQUE D'IDENTIFICATION KENNENZEICHNUNG STAHLN-HÄNGER	167
	AMO	ANILLA MAESTRA OVAL - GRADO 80 OBLONG MASTERLINK - 80 DEGREE MAILLE DE TÊTE OVALE - DEGRÉ 80 OVAL AUFHÄNGERINGS - GRAD 80	167
	AMOE	ANILLA MAESTRA OVAL ENSAMBLADA - GRADO 80 SUB-ASSEMBLY OBLONG MASTERLINK - 80 DEGREE MAILLE DE TÊTE TRIPLE - DEGRÉ 80 AUFHÄNGEKÖPFE - GRAD 80	167
	GA	GANCHO AUTOCIERRE - GRADO 80 SELF LOOKING EYE HOOK - 80 DEGREE CROCHET SECURITÉ AVEC LINGUET AUTOMATIQUE - DEGRÉ 80 SICHERHEITSHAKEN MIT AUTOMATISCHER SICHERUNG - GRAD 80	168
	GAG	GANCHO AUTOCIERRE GIRATORIO - GRADO 80 SWIVEL SELF LOOKING HOOK - 80 DEGREE CROCHET SECURITÉ À EMERILLON AVEC LINGUET AUTOMATIQUE DEGRÉ 80 DREHBARER SICHERHEITSHAKEN MIT AUTOMATISCHER SICHERUNG - GRAD 80	168
	GAH	GANCHO AUTOCIERRE HORQUILLA - GRADO 80 SELF LOOKING CLEVIS HOOK - 80 DEGREE CROCHET SECURITÉ À CHAPE AVEC LINGUET AUTOMATIQUE - DEGRÉ 80 SICHERHEITSHAKEN MIT GABEL UND AUTOMATISCHER SICHERUNG - GRAD 80	168

ELEMENTOS DE ELEVACIÓN
 LIFTING ELEMENTS / ELEMENTS DE LEVAGE / HUBELEMENTEN



















MAC	MALLA DE CONEXIÓN - GRADO 80 CONNECTING LINK - 80 DEGREE MAILLON DE JONCTION - DEGRÉ 80 VERBINDUNGSGLIED - GRAD 80	169
ACH	ACORTADOR CADENA - GRADO 80 SHORTENING CLUTCH - 80 DEGREE GRIFFE DE RACCOURCISSEMENT - DEGRÉ 80 VERKÜRZUNGSKLAUE - GRAD 80	169
GACH	GANCHO PARA ACORTAR - GRADO 80 CLEVIS GRAP HOOK - 80 DEGREE CROCHET DE RECCOURCISSEMENT À CHAPE - DEGRÉ 80 VERKÜRZUNGSHAKEN MIT GABEL - GRAD 80	169
58080	ANILLA ELEVACIÓN MACHO DIN 580 8.8 EYE BOLT DIN 580 8.8 ANNEAU DE LEVAGE MALE DIN 580 8.8 RINGSCHRAUBEN DIN 580 8.8	170
58280	ANILLA ELEVACIÓN HEMBRA DIN 582 8.8 EYE NUT DIN 582 8.8 ANNEAU DE LEVAGE FEMELLE DIN 582 8.8 RINGMUTTER DIN 582 8.8	170
CEA80	ANILLA ELEVACIÓN GIRATORIA CON ANILLA - GRADO 80 ROTATING EYE BOLT WITH RING - 80 DEGREE ANNEAU DE LEVAGE EMERILLON À OIEL - DEGRÉ 80 WIRBELBOCK - GRAD 80	171

NAÚTICA
 STAINLESS STEEL FITTINGS / FIXATIONS DE LEVAGE EN INOX / EDELSTAHLBESCHLÄGE



THHA4	TENSOR HORQUILLA - HORQUILLA INOXIDABLE A-4 STAINLESS STEEL AISI 316 TURNBUCKLES WITH 2 FORKS RIDOIRS À DEUX CHAPES EN ACIER INOX. A-4 WANTENSPANNER MIT ZWEI GABELN AUS ROSTFREIEM STAHL	172
THSA4	TENSOR HORQUILLAS SOLDADAS INOXIDABLE A-4 STAINLESS STEEL AISI 316 TURNBUCKLES WITH 2 WELDED FORKS RIDOIRS À DEUX CHAPES SOUDÉES EN ACIER INOX. A-4 WANTENSPANNER MIT ZWEI GESCHWEISSTEN GABELN AUS ROSTFREIEM STAHL	172
THGA4	TENSOR HORQUILLAS MÓVILES INOXIDABLE A-4 STAINLESS STEEL AISI 316 TURNBUCKLES WITH 2 JOINT FORKS RIDOIRS À DEUX CHAPES ARTICULÉES EN ACIER INOX. A-4 WANTENSPANNER MIT ZWEI GELENKGABELN AUS ROSTFREIEM STAHL	172
THTA4	TENSOR HORQUILLA - TERMINAL INOXIDABLE A-4 STAINLESS STEEL AISI 316 TURNBUCKLES WITH FORK & TERMINAL RIDOIRS À UNE CHAPE ET UN EMBOUT À SERTIR EN ACIER INOX. A-4 WANTENSPANNER MIT GABEL UND TERMINAL ZUM WALZEN	173
THGTA4	TENSOR HORQUILLA MÓVIL - TERMINAL INOXIDABLE A-4 STAINLESS STEEL AISI 316 TURNBUCKLES WITH JOINT FORK & TERMINAL RIDOIRS À CHAPE ARTICULÉE ET EMBOUT À SERTIR EN ACIER INOX. A-4 WANTENSPANNER MIT GELENKGABEL UND TERMINAL ZUM WALZEN	173
TAAA4	TENSOR ARO - ARO INOXIDABLE A-4 STAINLESS STEEL AISI 316 TURNBUCKLES WITH 2 EYES RIDOIRS À DEUX ANNEAU EN ACIER INOX. A-4 WANTENSPANNER MIT ZWEI ÖSEN AUS ROSTFREIEM STAHL	174
TAGA4	TENSOR ARO - GANCHO INOXIDABLE A-4 STAINLESS STEEL AISI 316 TURNBUCKLES EYE & HOOK RIDOIRS ANNEAUX ET CROCHET EN ACIER INOX. A-4 SPANNSCHLÖSSER MIT ÖSE UND HAKEN AUS ROSTFREIEM STAHL	174
TGGA4	TENSOR GANCHO - GANCHO INOXIDABLE A-4 STAINLESS STEEL AISI 316 TURNBUCKLES WITH TWO HOOKS RIDOIRS À DEUX CROCHETS EN ACIER INOX. A-4 SPANNSCHLÖSSER MIT ZWEI HAKEN AUS ROSTFREIEM STAHL	174
THPA4	TERMINAL PRENSBLE HORQUILLA INOXIDABLE A-4 STAINLESS STEEL AISI 316 FORK TERMINALS EMBOUTS À CHAPE À SERTIR EN ACIER INOX. A-4 GESCHWEISSTE GABELTERMINALS ZUM WALZEN AUS ROSTFREIEM STAHL	175
TOA4	TERMINAL PRENSABLE OJO INOXIDABLE A-4 STAINLESS STEEL AISI 316 EYE TERMINAL EMBOUTS À OIEL À SERTIR EN ACIER INOX. A-4 AUGENTERMINALS ZUM WALZEN AUS ROSTFREIEM STAHL	175
TPA4	TERMINAL PRENSABLE INOXIDABLE A-4 STAINLESS STEEL AISI 316 SWAGE STUDS EMBOUTS À SERTIR EN ACIER INOX. A-4 TERMINAL ZUM WALZEN AUS ROSTFREIEM STAHL	175
741A4	SUJETACABLES DIN 741 INOXIDABLE A-4 STAINLESS STEEL AISI 316 WIRE ROPE CLIPS SERRE-CABLES À ÉTRIÉR EN ACIER INOX. A-4 DRAHTSEILKLEMMEN AUS ROSTFREIEM STAHL	176
GCA4	GUARDACABOS INOXIDABLE A-4 STAINLESS STEEL AISI 316 THIMBLES COSSES COEUR EN ACIER INOX. A-4 KAUSCHEN AUS ROSTFREIEM STAHL	176
PCA4 / PCDA4	PRENSACABLES INOXIDABLE A-4 SIMPLE / DOBLE STAINLESS STEEL AISI 316 SIMPLEX / DUPLEX WIRE ROPE CLIPS SERRE-CABLES SIMPLEX / DUPLEX EN ACIER INOX. A-4 SIMPLEX / DUPLEX DRAHTSEILKLEMMEN AUS ROSTFREIEM STAHL	177

NAÚTICA

STAINLESS STEEL FITTINGS / FIXATIONS DE LEVAGE EN INOX / EDELSTAHLBESCHLÄGE

	ESEA4	GANCHO "S" INOXIDABLE A-4 STAINLESS STEEL AISI 316 "S" HOOK CROCHETS "S" EN ACIER INOX. A-4 "S" HAKEN AUS ROSTFREIEM STAHL	NUEVO NEW	177
	PH / MPH	PRENSA HIDRÁULICA DE 12 Tn 12 Tn HYDRAULIC CRIMPING PLIER PRESSE HYDRAULIQUE - 12 Tn HYDRAULISCHE PRESSZANGE - 12 Tn		178
	CCPL	ALICATES PICO DE LORO WIRE ROPE CUTTER CISAILLE POUR CÂBLE DRAHTSEILSCHERE		178
	GRA4	GRILLETE RECTO INOXIDABLE A-4 STAINLESS STEEL AISI 316 "D" SHACKLES MANILLES DROITES EN ACIER INOX. A-4 GERADE SCHÄKEL AUS ROSTFREIEM STAHL		179
	GLA4	GRILLETE LIRA INOXIDABLE A-4 STAINLESS STEEL AISI 316 BOW SHACKLES MANILLES LYRE EN ACIER INOX. A-4 GESCHWEIFTE SCHÄKEL AUS ROSTFREIEM STAHL		179
	GRR4	GRILLETE TORCIDO INOXIDABLE A-4 STAINLESS STEEL AISI 316 TWISTED SHACKLES MANILLES TORSÉES EN ACIER INOX. A-4 GEDREHTE SCHÄKEL AUS ROSTFREIEM STAHL		180
	GGHA4	GRILLETE GIRATORIO HORQUILLAS INOXIDABLE A-4 STAINLESS STEEL AISI 316 JAW & JAW SWIVELS EMERILLONS AVEC DEUX MANILLES EN ACIER INOX. A-4 WIRBEL GABEL-GABEL AUS ROSTFREIEM STAHL		180
	GGA4	GRILLETE GIRATORIO INOXIDABLE A-4 STAINLESS STEEL AISI 316 SWIVELS EMERILLONS EN ACIER INOX. A-4 WIRBEL AUS ROSTFREIEM STAHL		180
	MGGA4	MOSQUETÓN GRILLETE GIRATORIO INOXIDABLE A-4 STAINLESS STEEL AISI 316 SWIVEL SNAP SHACKLES MOUSQUETONS DE DRISSE À EMERILLON EN ACIER INOX. A-4 KARABINERHAKEN MIT WIRBEL AUS ROSTFREIEM STAHL		181
	MGA4	MOSQUETÓN GANCHO INOXIDABLE A-4 STAINLESS STEEL AISI 316 SPRING SNAPS MOUSQUETONS À RESORT EN ACIER INOX. A-4 KARABINERHAKEN AUS ROSTFREIEM STAHL		181
	MRA4	MALLA RÁPIDA INOXIDABLE A-4 STAINLESS STEEL AISI 316 QUICK LINKS MAILLONS RAPIDES EN ACIER INOX. A-4 KETTENGLIED AUS ROSTFREIEM STAHL		181
	MBA4	MOSQUETÓN BOMBERO INOXIDABLE A-4 STAINLESS STEEL AISI 316 SNAP HOOKS MOUSQUETONS EN ACIER INOX. A-4 KARABINERHAKEN AUS ROSTFREIEM STAHL		182
	MBSA4	MOSQUETÓN BOMBERO CON SEGURO INOXIDABLE A-4 SS. AISI 316 SNAP HOOKS WITH SAFETY SCREW MOUSQUETONS À VIS DE SÉCURITÉ EN ACIER INOX. A-4 KARABINERHAKEN MIT SCHRAUBSICHERUNG		182
	MAA4	MOSQUETÓN ASIMÉTRICO INOXIDABLE A-4 STAINLESS STEEL AISI 316 ASYMMETRICAL SNAP HOOKS MOUSQUETONS ASYMETRIQUES EN ACIER INOX. A-4 ASYMMETRISCHE KARABINERHAKEN AUS EDELSTAHL		182
	580A4	ANILLA ELEVACIÓN MACHO DIN 580 INOXIDABLE A-4 STAINLESS STEEL AISI 316 EYE BOLTS DIN 580 ANNEAU DE LEVAGE DIN 580 EN ACIER INOX. A-4 RINGSCHRAUBEN DIN 580 AUS ROSTFREIEM STAHL		183
	582A4	ANILLA ELEVACIÓN HEMBRA DIN 582 INOXIDABLE A-4 STAINLESS STEEL AISI 316 EYE NUTS DIN 582 ANNEAU DE LEVAGE DIN 582 EN ACIER INOX. A-4 RINGMÜTTERN DIN 582 AUS ROSTFREIEM STAHL		183
	BOA4	BULÓN OJO CON TUERCA Y ARANDELA INOXIDABLE A-4 STAINLESS STEEL AISI 316 EYE BOLTS WITH NUT & WASHER PITONS À OÛIL AVEC ÉCROU ET RONDELLE EN ACIER INOX. A-4 AUGENBOLZEN MIT FESTER ÖSE AUS ROSTFREIEM STAHL		183

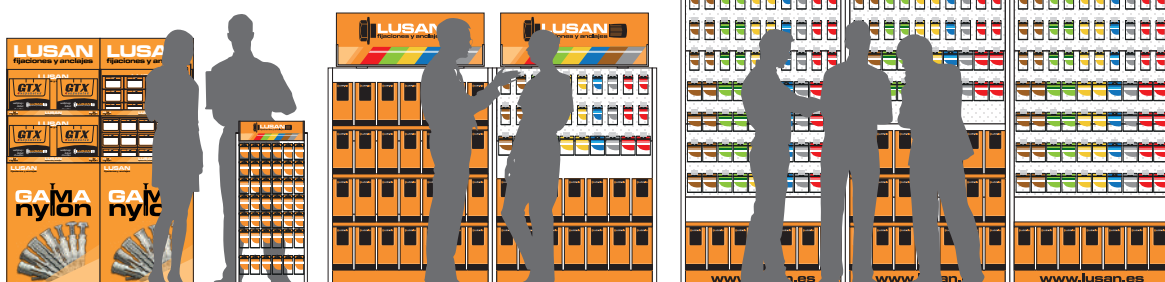
EXPOSITORES STANDS



184-186

NUEVO NEW

MATERIALES PARA SU APLICACIÓN

MATERIALS FOR APPLICATION / MATERIAUX POUR L'APPLICATION / MATERIAL FÜR DEN EINSATZ

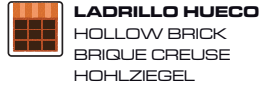

MATERIALES

MATERIALS / MATERIAUX / MATERIALEN

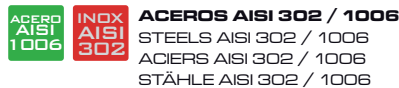
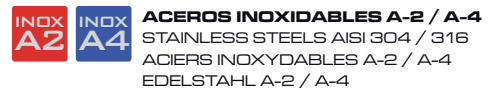

HERRAMIENTAS Y ACCESORIOS

TOOLS AND ACCESSORIES / OUTILS ET ACCESSORIES / WERKZEUGE UND ZUBEHÖR

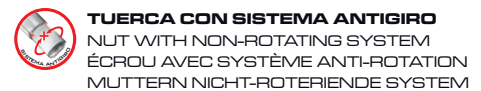

VARIOS

SEVERAL / PLUSIEURS / EINIGE

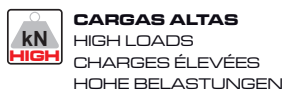
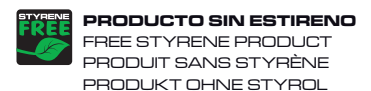



TARIFA DE PRECIOS Y CONDICIONES GENERALES DE VENTA

Las condiciones de venta detalladas son reconocidas y aceptadas por el comprador en el momento de concertarse el convenio de compra. El comprador acepta las mismas por el mero hecho de enviar o confirmar los pedidos efectuados a LUSAN FIJACIONES Y ANCLAJES S.L.

CONDICIONES DE PAGO

- Según Ley de Morosidad 15/2010 de entrada en vigor en 5 de Julio de 2010.
- Los documentos de pago (pagarés) deberán ser remitidos en un plazo máximo de 15 días después de recibir la factura.

PEDIDO MÍNIMO

- No se aceptarán pedidos inferiores a 60 euros.
- Todo pedido inferior a dicho importe tendrá un recargo de 6 euros.

DEVOLUCIONES

- No se acepta devolución de piezas especiales ni medidas fuera de catálogo.
- No se admitirán reclamaciones de material una vez transcurridos 15 días desde la entrega del mismo.
- No se admitirán devoluciones de material sin previo aviso y consentimiento por nuestra parte.
- Toda devolución por causa ajena a la empresa será a portes pagados por el cliente, aplicándose un 15% por gastos de gestión.

PORTES

Los portes serán pagados a partir de:

- Barcelona y su provincia	150 €
- Cataluña	300 €
- Resto de la península	500 €
- Baleares	600 €
- Islas Canarias	1.200 €

PRECIOS

Los precios de esta tarifa no incluyen el I.V.A., el cual será cargado en la factura.

PIEZAS ESPECIALES

- No se aceptan devoluciones de piezas especiales ni medidas fuera de catálogo.
- Plazos de entrega: Días laborables y en nuestro almacén.
- Las piezas especiales se suministran con un +/- 10% sobre la cantidad ofertada.
- El suministro quedará supeditado a la concesión de riesgo por parte de CYC.

EMBALAJES

Los embalajes son gratuitos.



LISTE DE PRIX ET CONDITIONS GÉNÉRALES DE VENTE

Terme détaillée de la vente sont reconnus et acceptés par l'acheteur au moment de la conclusion de l'accord d'achat. L'acheteur accepte la durée de la vente par le simple fait d'envoyer ou de confirmer les commandes effectuées à LUSAN FIJACIONES Y ANCLAJES S.L.

CONDITIONS DE PAIEMENT

- Selon la Loi de la délinquance 15/2010 de l'entrée en vigueur le 5 Juillet 2010.
- Les documents de paiement (de billets à ordre) doivent être présentés dans les 15 jours après réception de la facture.

COMMANDE MINIMUM

- Les commandes inférieures à 60 euros ne seront pas acceptées
- Toute commande inférieure à 60 euros aura un supplément de 6 euros.

RETOURS

- Ni sont acceptés les retours de pièces spéciales sur catalogue ou mesures.
- Les revendications de matériaux ne seront pas transmises onze ADMIS 15 jours de la livraison du matériel.
- Les retours d'articles ne seront pas admis sans préavis et sans le consentement de LUSAN FIJACIONES Y ANCLAJES S.L.
- Tous les retours pour des raisons indépendantes de la société seront en port payé par le client, application d'une taxe de traitement de 15%.

FRET

Le fret sera payé à partir de:

- Barcelone et sa province	150 €
- Catalogne	300 €
- Reste de la péninsule	500 €
- Baleares	600 €
- Îles Canaries	1.200 €

PRIX

Les prix de ce taux ne comprennent pas la TVA, Que sera facturé sur la facture.

PRODUITS SPÉCIAUX

- Nous n'acceptons pas de retour de produits spéciaux ni de dimensions hors catalogue.
- Délais de livraison: jours ouvrable et dans notre entrepôt.
- Les produits spéciaux seront livrés avec une tolérance de +/- 10% sur la quantité offerte.
- L'offre sera soumise à l'octroi de garantie par CYC.

EMBALLAGE

L'emballage est gratuit.



PRICE LIST AND GENERAL TERMS OF SALE

Detailed terms of sale are recognized and accepted by the buyer at the time of conclusion of the purchase agreement. The buyer accepts the terms of sale by the mere act of sending or confirming the orders effected to LUSAN FIJACIONES Y ANCLAJES S.L.

PAYMENT CONDITIONS

- According Delinquency Act 15/2010 of entry into force on July 5, 2010.
- Payment documents (promissory notes) should be submitted within 15 days after receiving the invoice.

MINIMUM ORDER

- Orders lower than 60 Euros will not be accepted
- Any order lower than 60 Euros will have a surcharge of 6 Euros.

RETURNS

- Neither are accepted returns of special pieces or measures out of catalogue.
- Claims of material will not be admitted once passed 15 days from the delivery of the material.
- Returns of material will not be admitted without previous notice and without consent from LUSAN FIJACIONES Y ANCLAJES S.L.
- All returns for reasons beyond the company will be freight prepaid by the customer, applying a 15% handling fee.

FREIGHT

The freight will be paid from:

- Barcelona and its province	150 €
- Catalonia	300 €
- Rest of the peninsula	500 €
- Baleares	600 €
- Canaries Islands	1.200 €

PRICES

The prices of this rate do not include the I.V.A., which will be charged in the invoice.

SPECIAL PIECES

- No refunds of special pieces out of catalog or measures are accepted.
- Delivery: working days and in our warehouse.
- The pieces are available with +/- 10% of the offered amount.
- The supply shall be subject to the granting of risk by CYC.

PACKAGING

The packaging is free.



PREISLISTE UND ALLGEMEINE VERKAUFSTERMIN

Detaillierte Verkaufstermin erkannt und zum Zeitpunkt der Feststellung des Kaufvertrages durch den Käufer akzeptiert. Der Käufer übernimmt den Begriff des Verkaufs durch den bloßen Akt der Versand oder der Bestätigung der Bestellung zu LUSAN FIJACIONES Y ANCLAJES S.L.

ZAHLUNGSBEDINGUNGEN

- Nach Kriminalität Gesetz 15 /2010 vom Inkrafttreten am 5. Juli , 2010.
- Zahlungsdokumente (Schuldscheinanleihen) sollte innerhalb von 15 Tagen nach Erhalt der Rechnung vorgelegt werden.

MINDESTBESTELL

- Bestellungen unter 60 Euro werden nicht akzeptiert.
- Jede Bestellung unter 60 Euro wird eine Gebühr von 6 Euro.

RETOUREN

- Weder sind Renditen von Spezialteilen aus Katalog oder Maßnahmen akzeptiert.
- Ansprüche von Materialien wird nicht weitergegeben werden elf zugelassen 15 Tagen ab der Lieferung des Materials.
- Versandkosten der Einzelteile wird nicht ohne vorherige Ankündigung und ohne Zustimmung von LUSAN FIJACIONES Y ANCLAJES S.L. zugelassen werden.
- Alle Rückkehr aus Gründen, die Unternehmen wird Fracht vom Kunden im Voraus bezahlt werden, Auftragen 15% Bearbeitungsgebühr.

GÜTER

Die Fracht wird von zu zahlen:

- Barcelona und seiner Provinz	150 €
- Katalonien	300 €
- Rest der Halbinsel	500 €
- Balearen	600 €
- Inseln Canaries	1.200 €

PREISE

Die Preise dieser Rate enthalten nicht die Mehrwertsteuer, que wird in der Rechnung berechnet.

SONDERTEILEN

- Es werden keine Rücksendungen von Sonderteilen noch Abmessungen ausserhalb des Katalogs akzeptiert.
- Lieferzeiten: Werktags in unserem Lorge.
- Bei Sonderteilen behalten wir uns eine 10% -ige Über -oder Unterlieferung der angebotenen Menge vor.
- Voraussetzung für die Lieferung ist eine Konzession des Risikos durch CYC.

VERPACKUNG

Die Verpackung ist frei.

FIXBOLT TORNILLO 8.8 - CE OPCIÓN 12

SLEEVE ANCHOR WITH HEX. HEAD SCREW 8.8 GRADE - CE OP.12
 CHEVILLE À DOUILLE AVEC VIS TÊTE HEXAGONALE CLASSE 8.8 - CE OP.12
 HÜLSENANKER MIT SECHSKANTSCHRAUBE KLASSE 8.8 - CE OP.12

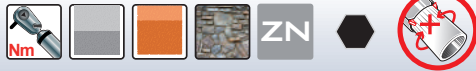
CE OP. 12
ANCLAJES PARA INSTALACIONES DE CALIDAD
**TORNILLO DE ACERO CINCADO
 DIN 933 CALIDAD 8.8**
**SISTEMA ANTIGIRO PARA
 FACILITAR LA INSTALACIÓN**
**PRODUCTO DE
 FABRICACIÓN NACIONAL**
**INSTALACIÓN EN TRES
 SENCILLOS PASOS CON LAS
 MÁXIMAS GARANTÍAS**
CERTIFICACIÓN CE

**IDEAL PARA
 MATERIALES
 MACIZOS**
PIEDRA LADRILLO HORMIGÓN

CAJA

CÓDIGO CODE CODE	MEDIDA SIZE MESURE	BROCA DRILL FORET	LLAVE KEY CLÉ	PA. (Nm.)	*CMA.		PROF. TALADRO HOLE DEPTH PROF. TROU	CINCADO		PRECIO TARIFA PRICE LIST PRIX TARIFS
					EXTRACCIÓN TENSION LOAD EXTRACTION	CIZALLADO SHEAR LOAD CISAILLEMENT		100	1.200	
FT08C	6x45	8	10	15	2,77	3,50	50	100	1.200	23,19
FT08L	6x60	8	10	15	2,77	3,50	65	100	1.200	26,88
FT10C	8x60	10	13	25	5,00	6,96	65	100	600	37,50
FT10L	8x80	10	13	25	5,00	6,96	85	100	600	44,50
FT12C	10x70	12	17	35	6,00	8,50	75	50	300	61,88
FT12L	10x100	12	17	35	6,00	8,50	105	50	300	76,50
FT16C	12x80	16	19	50	8,00	11,88	85	50	300	120,04
FT16L	12x110	16	19	50	8,00	11,88	115	25	150	145,63
FT20C	16x110	20	24	80	11,11	16,40	115	25	150	262,00
FT20L	16x140	20	24	80	11,11	16,40	145	25	150	353,10

CAJA

CÓDIGO CODE CODE	MEDIDA SIZE MESURE	BROCA DRILL FORET	LLAVE KEY CLÉ	PA. (Nm.)	*CMA.		PROF. TALADRO HOLE DEPTH PROF. TROU	CINCADO		PRECIO TARIFA PRICE LIST PRIX TARIFS
					EXTRACCIÓN TENSION LOAD EXTRACTION	CIZALLADO SHEAR LOAD CISAILLEMENT		100	600	
¹ FT08080	6x80	8	10	15	¹ 2,77	¹ 3,50	85	100	600	49,10
¹ FT08100	6x100	8	10	15	¹ 2,77	¹ 3,50	105	100	600	60,32
¹ FT11C	8x60	11	13	25	¹ 5,00	¹ 6,96	65	100	600	43,75
¹ FT11L	8x80	11	13	25	¹ 5,00	¹ 6,96	85	100	600	53,13
¹ FT10100	8x100	10	13	25	¹ 5,00	¹ 6,96	105	50	300	100,32
¹ FT10120	8x120	10	13	25	¹ 5,00	¹ 6,96	125	50	300	126,85
¹ FT10140	8x140	10	13	25	¹ 5,00	¹ 6,96	145	50	300	168,75
¹ FT14C	10x70	14	17	35	¹ 6,00	¹ 8,50	75	50	300	78,00
¹ FT14L	10x100	14	17	35	¹ 6,00	¹ 8,50	105	50	300	94,85
¹ FT12120	10x120	12	17	35	¹ 6,00	¹ 8,50	125	50	300	140,63
¹ FT12140	10x140	12	17	35	¹ 6,00	¹ 8,50	145	50	300	171,88

¹ VALORES PENDIENTES / ¹ PENDING VALUES / ¹ VALEURS DE PENTE

* COEFICIENTE DE SEGURIDAD ETAG INCLUIDO / ETAG SAFETY FACTOR INCLUDED / * COEFFICIENT DE SÉCURITÉ ETAG INCLUS / * SICHERHEITSAKTOR ENTHALTEN ETAG
 CMA.: CARGA MÁXIMA ADMISIBLE, PA.: PAR DE APRIETE. / CMA.: MAXIMUM ALLOWABLE LOAD. PA.: TORQUE / CMA.: CHARGE MAXIMALE ADMISIBLE. PA.: COUPLE DE SERRAGE

FIXBOLT TORNILLO 8.8 - CE OPCIÓN 12

SLEEVE ANCHOR WITH HEX. HEAD SCREW 8.8 GRADE - CE OP.12
 CHEVILLE À DOUILLE AVEC VIS TÊTE HEXAGONALE CLASSE 8.8 - CE OP.12
 HÜLSENANKER MIT SECHSKANTSCHRAUBE KLASSE 8.8 - CE OP.12



AUTOSERVICIO

CÓDIGO CODE CODE	MEDIDA SIZE MESURE	CINCADO		PRECIO TARIFA PRICE LIST PRIX TARIFS
	m.m.			€/BOLSA
BFFT08C	6x45 / Ø8	20	12	7,44
BFFT08L	6x60 / Ø8	15	12	5,63
BFFT10C	8x60 / Ø10	8	12	4,38
BFFT10L	8x80 / Ø10	8	12	4,82
BFFT12C	10x70 / Ø12	6	12	6,35
BFFT12L	10x100 / Ø12	5	12	7,38
BFFT16C	12x80 / Ø16	4	12	6,13

BLISTERS

CÓDIGO CODE CODE	MEDIDA SIZE MESURE	CINCADO		PRECIO TARIFA PRICE LIST PRIX TARIFS
	m.m.			€/BLISTER
BFT08C	6x45 / Ø8	2	15	2,89
BFT08L	6x60 / Ø8	2	15	2,89
BFT10C	8x60 / Ø10	2	15	2,89
BFT10L	8x80 / Ø10	2	15	2,89
BFT12C	10x70 / Ø12	2	15	2,89
BFT12L	10x100 / Ø12	2	15	2,89

PEDIDO MÍNIMO 1 EMBALAJE / MINIMUM ORDER 1 PACKAGING
 COMMANDE MINIMALE 1 EMBALLAGE / MINDESTBESTELLMENGE 1 VERPACKUNG

FIXBOLT TORNILLO INOXIDABLE A-2

SLEEVE ANCHOR WITH HEX. HEAD SCREW - STAINLESS STEEL AISI 304
 CHEVILLE À DOUILLE AVEC VIS TÊTE HEXAGONALE EN ACIER INOX. A-2
 HÜLSENANKER MIT SECHSKANTSCHRAUBE - EDELSTAHL A-2



CAJA

CÓDIGO CODE CODE	MEDIDA SIZE MESURE	BROCA DRILL FORET	PA.	LLAVE KEY CLÉ	*CMA.		PROF. TALADRO HOLE DEPTH PROF. TROU	CINCADO		PRECIO TARIFA PRICE LIST PRIX TARIFS
					EXTRACCIÓN TENSION LOAD EXTRACTION	CIZALLADO SHEAR LOAD CISAILLEMENT				
	m.m.	m.m.	(Nm.)	SW	(kN)	(kN)	m.m.			€/100 u.
FT208C	6x45	8	10	10	2,77	3,50	50	100	1.200	92,04
FT208L	6x60	8	10	10	2,77	3,50	65	100	1.200	100,72
FT210C	8x60	10	25	13	5,00	6,96	65	100	600	137,19
FT211C	8x60	11	25	13	5,00	6,96	65	100	600	173,15
FT210L	8x80	10	25	13	5,00	6,96	85	100	600	161,10
FT211L	8x80	11	25	13	5,00	6,96	85	100	600	204,75
FT212C	10x70	12	35	17	6,00	8,50	75	50	300	236,25
FT214C	10x70	14	35	17	6,00	8,50	75	50	300	324,19
FT212L	10x100	12	35	17	6,00	8,50	105	50	300	298,04
FT214L	10x100	14	35	17	6,00	8,50	105	50	300	361,63
FT216C	12x80	16	50	19	8,00	11,88	85	25	150	480,32
FT216L	12x110	16	50	19	8,00	11,88	115	25	150	608,10
FT220C	16x110	20	80	24	11,11	16,40	115	10	120	1.193,75
FT220L	16x140	20	80	24	11,11	16,40	145	10	60	1.249,69

AUTOSERVICIO

CÓDIGO CODE CODE	MEDIDA SIZE MESURE	INOX. A-2		PRECIO TARIFA PRICE LIST PRIX TARIFS
	m.m.			€/BOLSA
BFFT208C	6x45 / Ø8	12	12	12,38
BFFT208L	6x60 / Ø8	10	12	14,41
BFFT210C	8x60 / Ø10	6	12	14,35
BFFT210L	8x80 / Ø10	6	12	17,10
BFFT212C	10x70 / Ø12	4	12	18,12
BFFT212L	10x100 / Ø12	4	12	18,44

BLISTERS

CÓDIGO CODE CODE	MEDIDA SIZE MESURE	INOX. A-2		PRECIO TARIFA PRICE LIST PRIX TARIFS
	m.m.			€/BLISTER
BFT208C	6x45 / Ø8	2	15	3,89
BFT208L	6x60 / Ø8	2	15	3,89
BFT210C	8x60 / Ø10	2	15	3,89
BFT210L	8x80 / Ø10	2	15	3,89

PEDIDO MÍNIMO 1 EMBALAJE / MINIMUM ORDER 1 PACKAGING
 COMMANDE MINIMALE 1 EMBALLAGE / MINDESTBESTELLMENGE 1 VERPACKUNG

FIXBOLT TORNILLO INOXIDABLE A-4

SLEEVE ANCHOR WITH HEX. HEAD SCREW - STAINLESS STEEL AISI 316
CHEVILLE À DOUILLE AVEC VIS TÊTE HEXAGONALE EN ACIER INOX. A-4
HÜLSENANKER MIT SECHSKANTSCHRAUBE - EDELSTAHL A-4

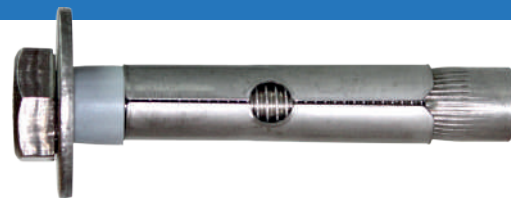

CAJA

CÓDIGO CODE CODE	MEDIDA SIZE MESURE	BROCA DRILL FORET	PA. (Nm.)	LLAVE KEY CLÉ SW	*CMA.		PROF. TALADRO HOLE DEPTH PROF. TROU	100	1.200	PRECIO TARIFA PRICE LIST PRIX TARIFS
					EXTRACCIÓN TENSION LOAD EXTRACTION (kN)	CIZALLADO SHEAR LOAD CISAILLEMENT (kN)				
FT408C	6x45	8	10	10	2,77	3,50	50	100	1.200	140,50
FT408L	6x60	8	10	10	2,77	3,50	65	100	1.200	157,67
FT410C	8x60	10	25	13	5,00	6,96	65	100	600	282,35
FT411C	8x60	11	25	13	5,00	6,96	65	100	600	311,67
FT410L	8x80	10	25	13	5,00	6,96	85	100	600	319,20
FT411L	8x80	11	25	13	5,00	6,96	85	100	600	359,17
FT412C	10x70	12	35	17	6,00	8,50	75	50	300	469,35
FT414C	10x70	14	35	17	6,00	8,50	75	50	300	488,12
FT412L	10x100	12	35	17	6,00	8,50	105	50	300	612,35
FT414L	10x100	14	35	17	6,00	8,50	105	50	300	633,15
FT416C	12x80	16	50	19	8,00	11,88	85	25	150	850,67
FT416L	12x110	16	50	19	8,00	11,88	115	25	150	1.049,87
FT420C	16x110	20	80	24	11,11	16,40	115	10	120	1.580,49
FT420L	16x140	20	80	24	11,11	16,40	145	10	60	2.375,65

1 CAMISA Y TUERCA EN INOX. AISI 304 / 1 BODY AND NUT MADE OF STAINLESS STEEL / 1 CORPS ET ÉCROU EN ACIER INOXYDABLE

FIXBOLT TORNILLO DIN 7991

SLEEVE ANCHOR WITH SCREW DIN 7991
CHEVILLE À DOUILLE AVEC VIS DIN 7991
HÜLSENANKER MIT SCHRAUBE DIN 7991



CAJA

CÓDIGO CODE CODE	MEDIDA SIZE MESURE	BROCA DRILL FORET	LLAVE KEY CLÉ S	PA. (Nm.)	*CMA.		PROF. TALADRO HOLE DEPTH PROF. TROU	100	600	PRECIO TARIFA PRICE LIST PRIX TARIFS
					EXTRACCIÓN TENSION LOAD EXTRACTION (kN)	CIZALLADO SHEAR LOAD CISAILLEMENT (kN)				
FT108C	6x45	8	4	10	2,77	3,50	50	100	600	43,13
FT108L	6x60	8	4	10	2,77	3,50	65	100	600	63,38
FT110C	8x60	10	5	25	5,00	6,90	65	100	600	70,38
FT111C	8x60	11	5	25	5,00	6,90	65	100	600	78,00
FT110L	8x80	10	5	25	5,00	6,90	85	100	600	95,63
FT111L	8x80	11	5	25	5,00	6,90	85	100	600	99,47
FT112C	10x70	12	6	35	6,00	8,50	75	50	300	125,63
FT112L	10x100	12	6	35	6,00	8,50	105	50	300	215,29

AUTOSERVICIO

CÓDIGO CODE CODE	MEDIDA SIZE MESURE	CINCADO		PRECIO TARIFA PRICE LIST PRIX TARIFS
		12	12	
BFFT108C	6x45 / Ø8	12	12	5,53
BFFT108L	6x60 / Ø8	12	12	6,94
BFFT110C	8x60 / Ø10	8	12	6,49
BFFT110L	8x80 / Ø10	8	12	9,22
BFFT112C	10x70 / Ø12	6	12	10,83
BFFT112L	10x100 / Ø12	4	12	7,77

BLISTERS

CÓDIGO CODE CODE	MEDIDA SIZE MESURE	CINCADO		PRECIO TARIFA PRICE LIST PRIX TARIFS
		2	15	
BFT108C	6x45 / Ø8	2	15	2,89
BFT108L	6x60 / Ø8	2	15	2,89
BFT110C	8x60 / Ø10	2	15	2,89
BFT110L	8x80 / Ø10	2	15	2,89

PEDIDO MÍNIMO 1 EMBALAJE / MINIMUM ORDER 1 PACKAGING
COMMANDE MINIMALE 1 EMBALLAGE / MINDESTBESTELLMENGE 1 VERPACKUNG

FIXBOLT TORNILLO DIN 7991 INOXIDABLE A-2

SLEEVE ANCHOR WITH SCREW DIN 7991 - S.S. AISI 304
 CHEVILLE À DOUILLE AVEC VIS DIN 7991 - ACIER INOX. A-2
 HÜLSENANKER MIT SCHRAUBE DIN 7991 - EDELSTAHL A-2

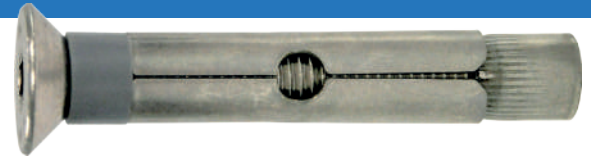
CAJA

CÓDIGO CODE CODE	MEDIDA SIZE MESURE	BROCA DRILL FORET	LLAVE KEY CLÉ	PA. (Nm.)	*CMA.		PROF. TALADRO HOLE DEPTH PROF. TROU	INOX. A-2		PRECIO TARIFA PRICE LIST PRIX TARIFS
					EXTRACCIÓN TENSION LOAD EXTRACTION (kN)	CIZALLADO SHEAR LOAD CISAILLEMENT (kN)		100	600	
FT1208C	6x45	8	4	10	2,77	3,50	50	100	600	90,63
FT1208L	6x60	8	4	10	2,77	3,50	65	100	600	115,63
FT1210C	8x60	10	5	25	5,00	6,96	65	100	600	171,25
FT1210L	8x80	10	5	25	5,00	6,96	85	100	600	202,50
FT1212C	10x70	12	6	35	6,00	8,50	75	50	300	270,63
FT1212L	10x100	12	6	35	8,00	8,50	105	50	300	316,88

AUTOSERVICIO

CÓDIGO CODE CODE	MEDIDA SIZE MESURE			PRECIO TARIFA PRICE LIST PRIX TARIFS
		10	12	
BFFT1208C	6x45 / Ø8	10	12	11,37
BFFT1208L	6x60 / Ø8	8	12	11,59
BFFT1210C	8x60 / Ø10	6	12	13,52
BFFT1210L	8x80 / Ø10	6	12	15,97
BFFT1212C	10x70 / Ø12	4	12	12,50
BFFT1212L	10x100 / Ø12	4	12	13,40

BLISTERS

CÓDIGO CODE CODE	MEDIDA SIZE MESURE			PRECIO TARIFA PRICE LIST PRIX TARIFS
		2	15	
BFT1208C	6x45 / Ø8	2	15	8,69
BFT1208L	6x60 / Ø8	2	15	8,69
BFT1210C	8x60 / Ø10	2	15	8,69
BFT1210L	8x80 / Ø10	2	15	8,69

PEDIDO MÍNIMO 1 EMBALAJE / MINIMUM ORDER 1 PACKAGING
 COMMANDE MINIMALE 1 EMBALLAGE / MINDESTBESTELLMENGE 1 VERPACKUNG

FIXBOLT TORNILLO 8.8 INVOLABLE TX

SLEEVE ANCHOR WITH MUSHROOM TX HEAD SCREW 8.8 GRADE (ANTI-THEFT)
 CHEVILLE À DOUILLE AVEC VIS TÊTE RONDE TX 8.8 (CACHE-TÊTE INAMOVIBLE)
 HÜLSENANKER MIT RUNDKOPFSCHRAUBE TX 8.8 (INNENSECHSRUND)

CAJA

CÓDIGO CODE CODE	MEDIDA SIZE MESURE	BROCA DRILL FORET	LLAVE KEY CLÉ	PA. (Nm.)	*CMA.		PROF. TALADRO HOLE DEPTH PROF. TROU	CINCADO		PRECIO TARIFA PRICE LIST PRIX TARIFS
					EXTRACCIÓN TENSION LOAD EXTRACTION (kN)	CIZALLADO SHEAR LOAD CISAILLEMENT (kN)		100	600	
FTIT10C	8x60	10	T-40	25	5,00	6,90	65	100	600	65,80
FTIT10L	8x80	10	T-40	25	5,00	6,90	85	100	600	92,40

AUTOSERVICIO

CÓDIGO CODE CODE	MEDIDA SIZE MESURE			PRECIO TARIFA PRICE LIST PRIX TARIFS
		8	12	
BFFTIT10C	8x60 / Ø10	8	12	9,85
BFFTIT10L	8x80 / Ø10	8	12	13,29

BLISTERS



CÓDIGO CODE CODE	MEDIDA SIZE MESURE			PRECIO TARIFA PRICE LIST PRIX TARIFS
		2	12	
BFTIT10C	8x60 / Ø10	2	12	2,89
BFTIT10L	8x80 / Ø10	2	12	2,89

PEDIDO MÍNIMO 1 EMBALAJE / MINIMUM ORDER 1 PACKAGING
 COMMANDE MINIMALE 1 EMBALLAGE / MINDESTBESTELLMENGE 1 VERPACKUNG



FIXBOLT ARO

 SLEEVE ANCHOR EYE / CHEVILLE À DOUILLE AVEC PITON
 HÜLSENANKER MIT AUGENSCHRAUBE



CAJA

CÓDIGO CODE CODE	MEDIDA SIZE MESURE	BROCA DRILL FORET	ØINT. ØINT. ØINT.	LLAVE KEY CLÉ	PA.	*CMA.	PROF. TALADRO HOLE DEPTH PROF. TROU	CINCADO		PRECIO TARIFA PRICE LIST PRIX TARIFS
										
	m.m.	m.m.	m.m.	SW	(Nm.)	(kN)	m.m.			€/100 u.
FA08C	6x45	8	10	10	10	0,70	60	100	600	42,07
FA10C	8x60	10	13	13	25	1,45	70	50	300	67,66
FA11C	8x60	11	13	13	25	1,45	70	50	300	73,94
FA12C	10x70	12	14	17	35	2,50	80	25	150	109,69
FA14C	10x70	14	14	17	35	2,50	80	25	150	124,94
FA16C	12x80	16	22	19	50	3,10	90	20	120	197,82

AUTOSERVICIO

CÓDIGO CODE CODE	MEDIDA SIZE MESURE	CINCADO		PRECIO TARIFA PRICE LIST PRIX TARIFS
				
	m.m.			€/BOLSA
BFFA08C	6x45 / Ø8	10	12	7,57
BFFA10C	8x60 / Ø10	5	12	5,47
BFFA12C	10x70 / Ø12	3	12	6,04

BLISTERS



CÓDIGO CODE CODE	MEDIDA SIZE MESURE	CINCADO		PRECIO TARIFA PRICE LIST PRIX TARIFS
				
	m.m.			€/BLISTER
BFA08C	6x45 / Ø8	2	15	2,89
BFA10C	8x60 / Ø10	2	15	2,89
BFA12C	10x70 / Ø12	2	10	2,89

PEDIDO MÍNIMO 1 EMBALAJE / MINIMUM ORDER 1 PACKAGING
 COMMANDE MINIMALE 1 EMBALLAGE / MINDESTBESTELLMENGE 1 VERPACKUNG

FIXBOLT ARO ESTAMPADO



 FORGED SLEEVE ANCHOR EYE
 CHEVILLE À DOUILLE AVEC PITON FORGÉ
 HÜLSENANKER MIT GESCHMIEDETE AUGENSCHRAUBE

CAJA

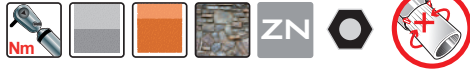

CÓDIGO CODE CODE	MEDIDA SIZE MESURE	BROCA DRILL FORET	ØINT. ØINT. ØINT.	LLAVE KEY CLÉ	PA.	*CMA.	PROF. TALADRO HOLE DEPTH PROF. TROU	CINCADO		PRECIO TARIFA PRICE LIST PRIX TARIFS
										
	m.m.	m.m.	m.m.	SW	(Nm.)	(kN)	m.m.			€/100 u.
FAE08C	6x45	8	10,0	10	10	2,77	60	100	600	78,13
FAE10C	8x60	10	11,8	13	25	5,00	70	50	300	102,35
FAE12C	10x70	12	14,5	17	35	6,00	80	25	150	157,13
FAE16C	12x80	16	17,0	19	50	8,00	90	20	120	271,88

FIXBOLT GANCHO



 SLEEVE ANCHOR HOOK
 CHEVILLE À DOUILLE AVEC CROCHET
 HÜLSENANKER MIT HAKEN

CAJA

CÓDIGO CODE CODE	MEDIDA SIZE MEASURE	BROCA DRILL FORET	ØINT. ØINT. ØINT.	LLAVE KEY CLÉ	PA. (Nm.)	*CMA. (kN)	PROF. TALADRO HOLE DEPTH PROF. TROU	CINCADO		PRECIO TARIFA PRICE LIST PRIX TARIFS
										
FG08C	6x45	8	10	10	10	0,70	60	100	600	€100 u. 42,07
FG10C	8x60	10	14	13	25	1,45	70	50	300	67,66
FG11C	8x60	11	14	13	25	1,45	70	50	300	73,94
FG12C	10x70	12	15	17	35	2,50	80	25	150	109,69
FG14C	10x70	14	15	17	35	2,50	80	25	150	124,94
FG16C	12x80	16	21	19	50	3,10	90	20	120	197,82

AUTOSERVICIO

CÓDIGO CODE CODE	MEDIDA SIZE MEASURE	CINCADO		PRECIO TARIFA PRICE LIST PRIX TARIFS
				
BFFG08C	6x45 / Ø8	10	12	7,57
BFFG10C	8x60 / Ø10	5	12	5,47
BFFG12C	10x70 / Ø12	3	12	6,04

BLISTERS



CÓDIGO CODE CODE	MEDIDA SIZE MEASURE	CINCADO		PRECIO TARIFA PRICE LIST PRIX TARIFS
				
BFG08C	6x45 / Ø8	2	15	2,89
BFG10C	8x60 / Ø10	2	15	2,89
BFG12C	10x70 / Ø12	2	10	2,89

PEDIDO MÍNIMO 1 EMBALAJE / MINIMUM ORDER 1 PACKAGING
 COMMANDE MINIMALE 1 EMBALLAGE / MINDESTBESTELLMENGE 1 VERPACKUNG

FIXBOLT GANCHO ESTAMPADO

 FORGED SLEEVE ANCHOR HOOK
 CHEVILLE À DOUILLE AVEC CROCHET FORGÉ
 HÜLSENANKER MIT GESCHMIEDETE HAKEN



CAJA

CÓDIGO CODE CODE	MEDIDA SIZE MEASURE	BROCA DRILL FORET	ØINT. ØINT. ØINT.	LLAVE KEY CLÉ	PA. (Nm.)	*CMA. (kN)	PROF. TALADRO HOLE DEPTH PROF. TROU	CINCADO		PRECIO TARIFA PRICE LIST PRIX TARIFS
										
FGE08C	6x45	8	10	10	10	0,90	60	100	600	€100 u. 78,13
FGE10C	8x60	10	14	13	25	1,60	70	50	300	102,35
FGE12C	10x70	12	15	17	35	2,90	80	25	150	157,13
FGE16C	12x80	16	21	19	50	4,00	90	20	120	271,88



FIXBOLT ARO INOXIDABLE A-2

SLEEVE ANCHOR EYE - STAINLESS STEEL AISI 304
 CHEVILLE À DOUILLE AVEC PITON - ACIER INOX. A-2
 HÜLSENANKER MIT AUGENSCHRAUBE - EDELSTAHL A-2

CAJA

CÓDIGO CODE CODE	MEDIDA SIZE MEASURE	BROCA DRILL FORET	ØINT. ØINT. ØINT.	LLAVE KEY CLÉ	PA.	*CMA.	PROF. TALADRO HOLE DEPTH PROF. TROU	INOX. A-2		PRECIO TARIFA PRICE LIST PRIX TARIFS
										
										€/100 u.
FA208C	6x45	8	10,0	10	10	2,77	60	100	100	325,00
FA210C	8x60	10	11,8	13	25	5,00	70	50	50	484,38
FA211C	8x60	11	11,8	13	25	5,00	70	50	50	562,50
FA212C	10x70	12	14,5	17	35	6,00	80	25	25	710,29
FA214C	10x70	14	14,5	17	35	6,00	80	25	25	875,00
FA216C	12x80	16	17,0	19	50	8,00	90	20	20	1.587,50

AUTOSERVICIO

CÓDIGO CODE CODE	MEDIDA SIZE MEASURE	INOX. A-2		PRECIO TARIFA PRICE LIST PRIX TARIFS
				
				€/BOLSA
BFFA208C	6x45 / Ø8	4	12	20,00
BFFA210C	8x60 / Ø10	2	12	15,38
BFFA212C	10x70 / Ø12	2	12	20,10

BLISTERS



CÓDIGO CODE CODE	MEDIDA SIZE MEASURE	INOX. A-2		PRECIO TARIFA PRICE LIST PRIX TARIFS
				
				€/BLISTER
BFA208C	6x45 / Ø8	2	15	8,69
BFA210C	8x60 / Ø10	2	15	11,25

PEDIDO MÍNIMO 1 EMBALAJE / MINIMUM ORDER 1 PACKAGING
 COMMANDE MINIMALE 1 EMBALLAGE / MINDESTBESTELLMENGE 1 VERPACKUNG



FIXBOLT GANCHO INOXIDABLE A-2

SLEEVE ANCHOR HOOK - STAINLESS STEEL AISI 304
 CHEVILLE À DOUILLE AVEC CROCHET - ACIER INOX. A-2
 HÜLSENANKER HAKEN - EDELSTAHL A-2

CAJA

CÓDIGO CODE CODE	MEDIDA SIZE MEASURE	BROCA DRILL FORET	ØINT. ØINT. ØINT.	LLAVE KEY CLÉ	PA.	*CMA.	PROF. TALADRO HOLE DEPTH PROF. TROU	INOX. A-2		PRECIO TARIFA PRICE LIST PRIX TARIFS
										
										€/100 u.
FG208C	6x45	8	10	10	10	0,90	60	100	600	319,50
FG210C	8x60	10	14	13	25	1,60	70	50	300	474,69
FG211C	8x60	11	14	13	25	1,60	70	50	300	562,50
FG212C	10x70	12	15	17	35	2,90	80	25	150	695,97
FG214C	10x70	14	15	17	35	2,90	80	25	150	875,00
FG216C	12x80	16	21	19	50	4,00	90	20	120	1.587,50

AUTOSERVICIO

CÓDIGO CODE CODE	MEDIDA SIZE MEASURE	INOX. A-2		PRECIO TARIFA PRICE LIST PRIX TARIFS
				
				€/BOLSA
BFFG208C	6x45 / Ø8	4	12	20,00
BFFG210C	8x60 / Ø10	2	12	15,38
BFFG212C	10x70 / Ø12	2	12	20,10

BLISTERS

CÓDIGO CODE CODE	MEDIDA SIZE MEASURE	INOX. A-2		PRECIO TARIFA PRICE LIST PRIX TARIFS
				
				€/BLISTER
BFG208C	6x45 / Ø8	2	15	8,69
BFG210C	8x60 / Ø10	2	15	11,25

PEDIDO MÍNIMO 1 EMBALAJE / MINIMUM ORDER 1 PACKAGING
 COMMANDE MINIMALE 1 EMBALLAGE / MINDESTBESTELLMENGE 1 VERPACKUNG

ANCLAJE ANILLA SN CINCADO

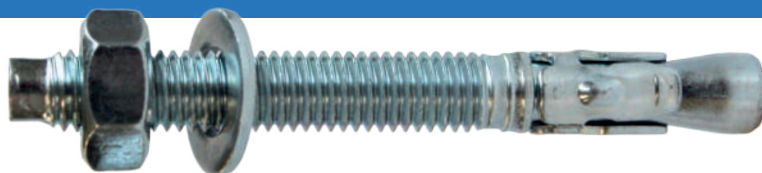
 WEDGE ANCHOR - ZINC PLATED
 GOUJON D'ANCRAGE EN ACIER ZINGUÉ
 ANKER MIT FEINBLECH VERZINKT

CAJA

CÓDIGO CODE CODE	MEDIDA SIZE MEASURE (MxL) m.m.	BROCA DRILL FORET (Ø) m.m.	PA. (Nm.)	LLAVE KEY CLÉ SW	*CMA.*		100	1.200	PRECIO TARIFA PRICE LIST PRIX TARIFS €/100 u.
					EXTRACCIÓN TENSION LOAD EXTRACTION (kN)	CIZALLADO SHEAR LOAD DISAILLEMENT (kN)			
SNZ06045	6x45	6	10	10	0,61	0,59	100	1.200	21,60
SNZ06060	6x60	6	10	10	0,80	0,59	100	1.200	23,04
SNZ06120	6x120	6	10	10	0,80	0,59	100	600	34,35
SNZ06140	6x140	6	10	10	0,80	0,59	100	600	40,60
SNZ08050	8x50	8	20	13	0,92	0,54	100	1.200	26,90
SNZ08075	8x75	8	20	13	1,16	1,08	100	600	31,57
SNZ08090	8x90	8	20	13	1,16	1,08	100	600	40,60
SNZ08115	8x115	8	20	13	1,16	1,08	100	600	43,80
SNZ10070	10x70	10	40	17	1,03	1,23	50	600	46,44
SNZ10090	10x90	10	40	17	1,29	1,71	50	300	49,70
SNZ10120	10x120	10	40	17	1,29	1,71	50	300	63,34
SNZ12075	12x75	12	50	19	1,80	1,38	25	300	61,70
SNZ12090	12x90	12	50	19	2,02	2,16	25	300	70,47
SNZ12110	12x110	12	50	19	2,02	2,40	25	300	76,77
SNZ12140	12x140	12	50	19	2,02	2,40	25	150	99,53
SNZ12160	12x160	12	50	19	2,02	2,40	20	120	122,17
SNZ12180	12x180	12	50	19	2,02	2,40	20	120	153,13
SNZ14080	14x80	14	85	22	2,40	2,20	25	150	150,00
SNZ14095	14x95	14	85	22	2,40	2,20	25	150	160,97
SNZ14110	14x110	14	85	22	2,40	2,20	25	150	167,19
SNZ14130	14x130	14	85	22	2,40	2,20	25	150	179,57
SNZ14145	14x145	14	85	22	2,40	2,20	25	150	201,19
SNZ14180	14x180	14	85	22	2,40	2,20	25	150	218,75
SNZ16090	16x90	16	125	24	1,39	1,67	25	150	126,64
SNZ16125	16x125	16	125	24	2,83	4,47	25	150	151,27
SNZ16145	16x145	16	125	24	2,83	4,47	25	150	169,40
SNZ16180	16x180	16	125	24	2,83	4,47	10	60	246,57
SNZ16220	16x220	16	125	24	2,83	4,47	10	40	288,30
SNZ20160	20x160	20	250	30	3,60	6,20	10	60	312,43
SNZ20220	20x220	20	250	30	4,04	6,55	10	40	473,13
SNZ20270	20x270	20	250	30	4,04	6,55	10	40	537,30

AUTOSERVICIO

CÓDIGO CODE CODE	MEDIDA SIZE MEASURE (MxL) m.m.	CINCADO		PRECIO TARIFA PRICE LIST PRIX TARIFS €/BOLSA
		25	12	
BFSNZ06060	6x60	25	12	11,83
BFSNZ08075	8x75	12	12	9,79
BFSNZ08090	8x90	10	12	8,13
BFSNZ08115	8x115	8	12	6,20
BFSNZ10070	10x70	8	12	7,19
BFSNZ10090	10x90	6	12	6,38
BFSNZ10120	10x120	5	12	6,32
BFSNZ12090	12x90	4	12	8,13
BFSNZ12110	12x110	4	12	5,82

BLISTERS

CÓDIGO CODE CODE	MEDIDA SIZE MEASURE (MxL) m.m.	CINCADO		PRECIO TARIFA PRICE LIST PRIX TARIFS €/BLISTER
		2	20	
BSN06045	6x45	2	20	2,89
BSN06060	6x60	2	20	2,89
BSN08075	8x75	2	15	2,89
BSN10070	10x70	2	12	2,89
BSN10090	10x90	2	12	2,89
BSN12090	12x90	2	10	2,89
BSN12110	12x110	2	10	2,89

**PEDIDO MÍNIMO 1 EMBALAJE / MINIMUM ORDER 1 PACKAGING
 COMMANDE MINIMALE 1 EMBALLAGE / MINDESTBESTELLMENGE 1 VERPACKUNG**

ANCLAJE ANILLA SN HOMOLOGADO - CE OPCIÓN 1

WEDGE ANCHOR - CE OPT.1
 GOUJON D'ANCRAGE - CE OP.1
 ANKER MIT FEINBLECH - CE OPT.1



CARACTERÍSTICAS, VENTAJAS Y HOMOLOGACIONES

- Para fijaciones extra pesadas en hormigón fisurado y no fisurado de clase de resistencia min C20/25 y max C50/60, según la Evaluación Técnica Europea.
- Categoría de prestación C2-C1 para fijaciones en zonas sísmicas, según el ETAG 001 - ANEXO E.
- Resistencia al fuego R30-R120, según el Technical Report TR 020.
- Cuerpo del anclaje con resistencia mínima de 800 N/mm².
- Instalación rápida y correcta gracias a la anilla coloreada (profundidad de inserción del anclaje en el hormigón).
- Acero cincado exento de Cr-VI (conforme ROHS).
- Tiempo de espera nulo para la aplicación de la carga.
- Utilizable también en hormigón de clase inferior a C20/25 y piedra natural maciza (ambas excepciones no están incluidas en el ETA y, por lo tanto, necesitan de ensayos específicos).



MARCA DE LA MÍNIMA PROFUNDIDAD DE INSERCIÓN

RESISTENCIA MÍNIMA DE 800 N/MM² (CUERPO)

GRAPA ESPECIAL DE EXPANSIÓN

CAJA

CINCADO

CÓDIGO CODE CODE	MEDIDA SIZE MEASURE	BROCA DRILL FORET	PA.	ESPESOR A FIJAR THICKNESS TO FIX ÉPAISSEUR	*CMA.		PROF. TALADRO HOLE DEPTH PROF. TROU	100	500	PRECIO TARIFA PRICE LIST PRIX TARIFS
					EXTRACCIÓN TENSION LOAD EXTRACTION	CIZALLADO SHEAR LOAD CISAILLEMENT				
	(MxL) m.m.	(∅) m.m.	(Nm.)	m.m.	(kN)	(kN)	m.m.			€/100 U.
SNH108080	8x80	8	20	10	3,30	5,70	65	100	500	94,29
SNH108110	8x110	8	20	40	3,30	5,70	65	50	500	118,35
SNH110095	10x95	10	45	10	6,40	9,50	85	50	250	121,41
SNH110125	10x125	10	45	40	6,40	9,50	85	50	250	154,91
SNH110145	10x145	10	45	60	6,40	9,50	85	50	250	180,44
SNH112115	12x115	12	60	10	7,90	16,70	105	25	125	206,94
SNH112145	12x145	12	60	40	7,90	16,70	105	25	125	253,75
SNH112165	12x165	12	60	60	7,90	16,70	105	25	125	304,19
SNH116130	16x130	16	110	5	16,70	28,60	120	25	125	434,10
SNH116145	16x145	16	110	20	16,70	28,60	120	20	100	461,66
SNH116165	16x165	16	110	40	16,70	28,60	120	20	100	576,50
SNH116225	16x225	16	110	100	16,70	28,60	120	10	50	741,50
SNH120170	20x170	20	200	30	23,30	45,20	135	10	50	1.026,94
SNH120200	20x200	20	200	60	23,30	45,20	135	10	50	1.228,54

SE REQUIERE CILINDRO "SPS" PARA INSTALACIONES EN ZONA SÍSMICA (PAG. 17).

APLICACIÓN

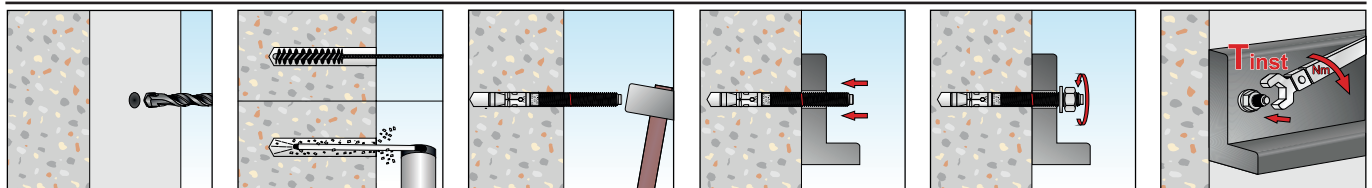

PROTECTOR SÍSMICO "SPS" - CILINDRO ESPECIAL PARA ANCLAJE EN ZONA SÍSMICA

"SPS" SEISMIC PROTECTOR
PROTECTEUR SISMIQUE "SPS"
SEISMISCHER PROTEKTOR "SPS"

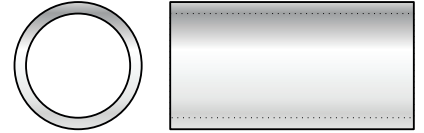

EVITA EL EFECTO DE MARTILLO



MEDIA CAPACIDAD DE RESISTENCIA AL CORTE

En presencia de una brecha anular, el diseño para la resistencia al corte se ve afectado con una reducción del 50%.



COMPLETA CAPACIDAD DE RESISTENCIA AL CORTE

El cilindro especial "SPS", se ajusta perfectamente en la brecha anular entre el anclaje y la pieza a fijar, evitando así el efecto de martilleo producido por la actividad sísmica. En este caso no hay factor de reducción.

EL PROTECTOR "SPS" DEBE UTILIZARSE JUNTO EL ANCLAJE "SNH1" EN CASO DE INSTALACIÓN EN ZONA SÍSMICA SEGÚN ETAG 001 - ANEXO E.

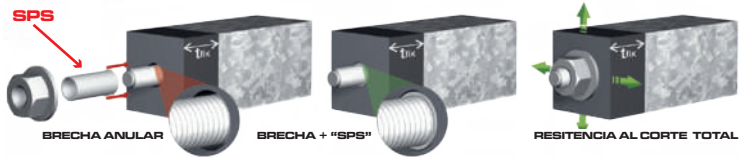

CAJA

CINCADO

CÓDIGO CODE CODE	MEDIDA SIZE MEASURE (∅xL) m.m.	∅ ANCLAJE SNH1 SNH1 ANCHOR ∅ ∅ ANCRAGE SNH1 m.m.	CANTIDAD		PRECIO TARIFA PRICE LIST PRIX TARIFS €/100 u.
SPS12010	12x10	10	50	500	30,63
SPS12040	12x40	10	50	500	40,16
SPS12060	12x60	10	50	500	46,47
SPS14010	14x10	12	30	300	49,29
SPS14040	14x40	12	30	300	61,32
SPS14060	14x60	12	30	300	69,35
SPS18005	18x5	16	25	250	84,29
SPS18020	18x20	16	20	200	94,88
SPS18040	18x40	16	20	200	105,22
SPS18100	18x100	16	10	100	150,41
SPS22030	22x30	20	10	100	221,38
SPS22060	22x60	20	10	100	240,79



SE REQUIERE ANCLAJE SNH1 PARA INSTALACIONES EN ZONA SÍSMICA (PAG. 16).

APLICACIÓN

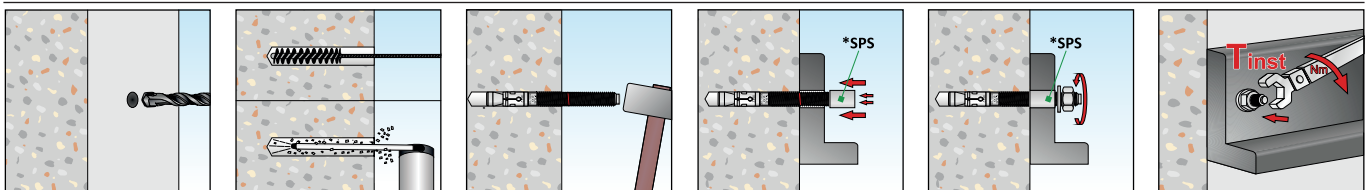

* El protector sísmico se debe instalar solo en caso de aplicación en zona sísmica.

ANCLAJE ANILLA SN HOMOLOGADO - CE OPCIÓN 7

WEDGE ANCHOR - CE OPT.7
 GOUJON D'ANCRAGE - CE OP.7
 ANKER MIT FEINBLECH - CE OPT.7

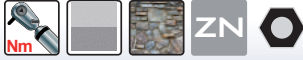

CE OP. 7

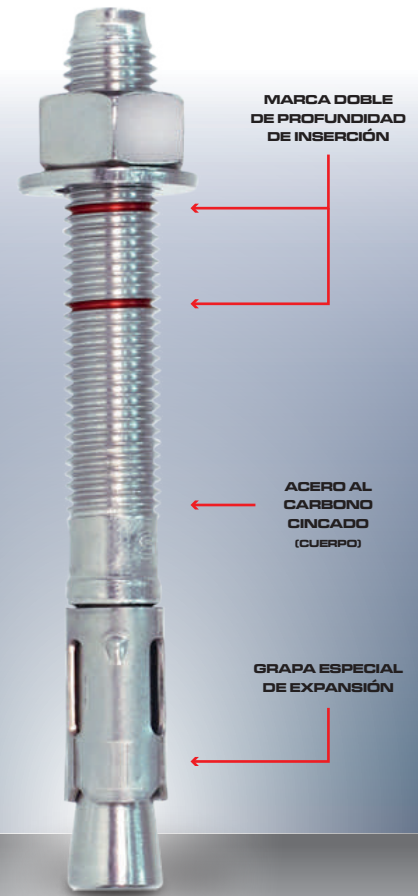

CARACTERÍSTICAS, VENTAJAS Y HOMOLOGACIONES

- Los anclajes SNH han conseguido la Aprobación Técnica Europea (ETA) según ETAG001 - Parte 1 y 2, Opción 7, para uso en hormigón no fisurado para aplicaciones estructurales.
- Anclaje de acero al carbono, cincado.
- Dos profundidades de instalaciones: instalación con profundidad estándar para cargas pesadas y con profundidad reducida para hormigón de bajo espesor (sólo para diámetros 8, 10, 12).
- Homologado para fijaciones estructurales en hormigón de clase de resistencia desde C20/25 hasta C50/60, según el "Documento de Idoneidad Técnica Europeo".
- Seguridad en el empleo gracias a la aplicación del par de apriete.
- Tiempo de espera nulo para la aplicación de la carga.
- Utilizable también en hormigón de clase inferior a C20/25 y piedra natural maciza (ambas las excepciones no están incluidas en el ETA y, por lo tanto, necesitan de ensayos específicos).



CAJA

CINCADO

CÓDIGO CODE CODE	MEDIDA SIZE MESURE	BROCA DRILL FORET	PA.	LLAVE KEY CLÉ	ESPESOR A FIJAR THICKNESS TO FIX ÉPAISSEUR	EXTRACCIÓN TENSION LOAD EXTRACTION	*CMA.	CIZALLADO SHEAR LOAD CISAILLEMENT	PROF. TALADRO HOLE DEPTH PROF. TROU			PRECIO TARIFA PRICE LIST PRIX TARIFS
	(MxL) m.m.	(∅) m.m.	(Nm.)	SW	(tfix - tfix,red) m.m.	(kN)		(kN)	m.m.			€/100 u.
SNH08075	8x75	8	20	13	5-18	5,00		5,30	65	100	500	58,38
SNH08090	8x90	8	20	13	20-33	5,00		5,30	65	100	500	62,10
SNH08115	8x115	8	20	13	45-58	5,00		5,30	65	50	500	71,38
SNH10080	10x80	10	35	17	NA-13	6,00		8,40	75	50	250	82,66
SNH10090	10x90	10	35	17	10-23	6,00		8,40	75	50	250	80,44
SNH10120	10x120	10	35	17	40-53	6,00		8,40	75	50	250	103,88
SNH10150	10x150	10	35	17	70-83	6,00		8,40	75	50	250	131,79
SMH12X90	12x90	12	60	19	NA-13	9,30		11,80	85	25	250	119,82
SNH12110	12x110	12	60	19	18-33	9,30		11,80	85	25	125	137,04
SNH12140	12x140	12	60	19	48-63	9,30		11,80	85	25	125	167,50
SNH12160	12x160	12	60	19	68-83	9,30		11,80	85	25	125	182,22
SNH16125	16x125	16	120	24	3-NA	16,00		21,90	110	25	125	262,32
SNH16145	16x145	16	120	24	23-NA	16,00		21,90	110	20	100	280,85
SNH16170	16x170	16	120	24	48-NA	16,00		21,90	110	15	75	324,16
SNH20170	20x170	20	240	30	23-NA	17,00		32,10	135	10	50	487,50

APLICACIÓN

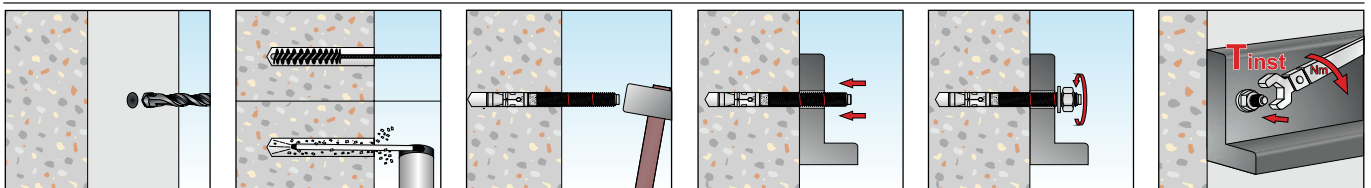

ANCLAJE ANILLA SN INOXIDABLE A-2

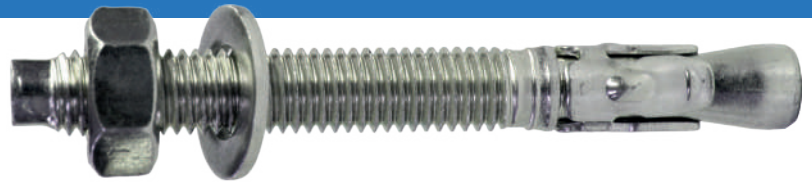
 STAINLESS STEEL AISI 304 WEDGE ANCHOR
 GOUJON D'ANCRAGE EN ACIER INOX. A-2
 ANKER MIT FEINBLECH - EDELSTAHL A-2

CAJA

CÓDIGO CODE CODE	MEDIDA SIZE MEASURE	BROCA DRILL FORET	LLAVE KEY CLÉ	PA. (Nm.)	*CMA.		PRECIO TARIFA PRICE LIST PRIX TARIFS
					EXTRACCIÓN TENSION LOAD EXTRACTION (kN)	CIZALLADO SHEAR LOAD CISAILLEMENT (kN)	
SNA206065	6x65	6	10	10	3,2	1,7	100 1.200 162,50
SNA206120	6x120	6	10	10	3,2	1,7	100 800 184,38
SNA206140	6x140	6	10	10	3,2	1,7	100 800 194,50
SNA208080	8x80	8	13	20	4,9	3,7	100 800 193,75
SNA208090	8x90	8	13	20	4,9	3,7	100 800 218,75
SNA210075	10x75	10	17	40	6,1	4,4	50 400 300,00
SNA210090	10x90	10	17	40	6,1	4,4	50 400 334,38
SNA210120	10x120	10	17	40	6,1	4,4	50 300 393,75
SNA212080	12x80	12	19	50	9,2	9,0	50 300 425,00
SNA212090	12x90	12	19	50	9,2	9,0	50 300 428,13
SNA212110	12x110	12	19	50	9,2	9,0	50 300 462,50
SNA212140	12x140	12	19	50	9,2	9,0	50 300 581,25
SNA216125	16x125	16	24	125	14,5	22,2	25 150 965,32
SNA216145	16x145	16	24	125	14,5	22,2	25 150 1.153,13
SNA220170	20x170	20	30	250	21,5	34,5	10 60 1.962,50
SNA220215	20x215	20	30	250	21,5	34,5	10 30 2.162,50

AUTOSERVICIO

CÓDIGO CODE CODE	MEDIDA SIZE MEASURE	PRECIO TARIFA PRICE LIST PRIX TARIFS
BFSNA206065	6x65	22,71
BFSNA208075	8x75	29,75
BFSNA208090	8x90	33,88
BFSNA210075	10x75	36,57
BFSNA210090	10x90	36,88
BFSNA210120	10x120	38,29
BFSNA212090	12x90	31,79
BFSNA212110	12x110	37,60

BLISTERS

CÓDIGO CODE CODE	MEDIDA SIZE MEASURE	PRECIO TARIFA PRICE LIST PRIX TARIFS
BSNA206065	6x65	3,89
BSNA208075	8x75	3,89
BSNA210090	10x90	3,89

**PEDIDO MÍNIMO 1 EMBALAJE
MINIMUM ORDER 1 PACKAGING**
ANCLAJE ANILLA SN INOXIDABLE A-4

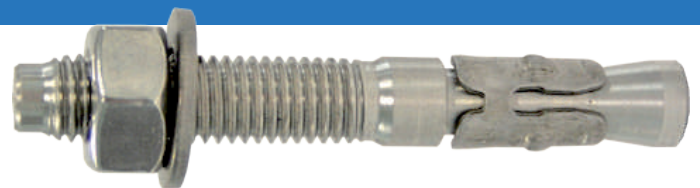
 STAINLESS STEEL AISI 316 WEDGE ANCHOR
 GOUJON D'ANCRAGE EN ACIER INOX. A-4
 ANKER MIT FEINBLECH - EDELSTAHL A-4

CAJA

CÓDIGO CODE CODE	MEDIDA SIZE MEASURE	BROCA DRILL FORET	LLAVE KEY CLÉ	PA. (Nm.)	*CMA.		PRECIO TARIFA PRICE LIST PRIX TARIFS
					EXTRACCIÓN TENSION LOAD EXTRACTION (kN)	CIZALLADO SHEAR LOAD CISAILLEMENT (kN)	
SNA406065	6x65	6	10	10	3,2	1,7	100 1.200 158,02
SNA408075	8x75	8	13	20	4,9	3,7	100 800 207,82
SNA410075	10x75	10	17	40	6,1	4,4	50 400 335,43
SNA410090	10x90	10	17	40	6,1	4,4	50 400 364,60
SNA410120	10x120	10	17	40	6,1	4,4	50 300 419,28
SNA412080	12x80	12	19	50	9,2	9,0	50 300 475,21
SNA412110	12x110	12	19	50	9,2	9,0	50 300 515,31
SNA412160	12x160	12	19	50	9,2	9,0	25 150 768,58
SNA416145	16x145	16	24	125	14,5	22,2	25 150 1.151,33
SNA420170	20x170	20	30	150	21,5	34,5	10 60 2.320,11
SNA420215	20x215	20	30	150	21,5	34,5	10 60 2.651,55

ANCLAJE ANILLA SN INOXIDABLE A-4 HOMOLOGADO - CE OPCIÓN 7

STAINLESS STEEL AISI 316 WEDGE ANCHOR - CE OPT.7
 GOUJON D'ANCRAGE EN ACIER INOX. A-4 - CE OP.7
 ANKER MIT FEINBLECH - EDELSTAHL A-4 - CE OPT.7



CE OP. 7

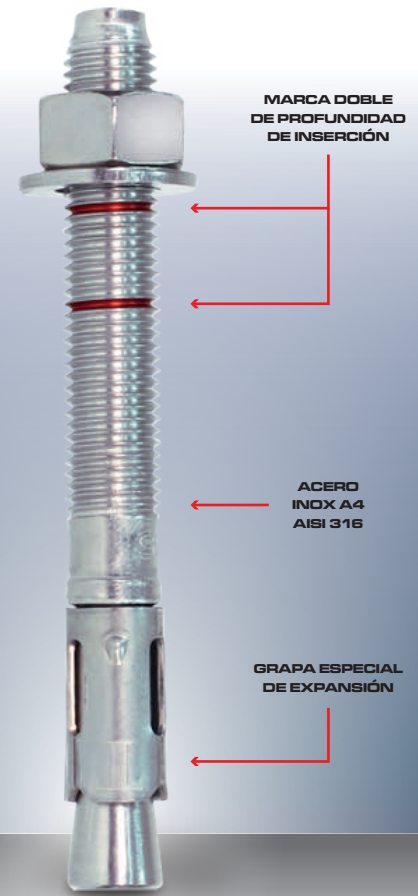

CARACTERÍSTICAS, VENTAJAS Y HOMOLOGACIONES

- Los anclajes SNHA4 han conseguido la Aprobación Técnica Europea (ETA) según ETAG001 - Parte 1 y 2, Opción 7, para uso en hormigón no fisurado para aplicaciones estructurales.
- Anclaje de acero inoxidable A4 (AISI 316).
- Dos profundidades de instalaciones: instalación con profundidad estándar para cargas pesadas y con profundidad reducida para hormigón de bajo espesor (sólo para diámetros 8, 10, 12).
- Homologado para fijaciones estructurales en hormigón de clase de resistencia desde C20/25 hasta C50/60, según el "Documento de Idoneidad Técnica Europeo".
- Seguridad en el empleo gracias a la aplicación del par de apriete.
- Tiempo de espera nulo para la aplicación de la carga.
- Utilizable también en hormigón de clase inferior a C20/25 y piedra natural maciza (ambas las excepciones no están incluidas en el ETA y, por lo tanto, necesitan de ensayos específicos).



CAJA

INOX. A-4

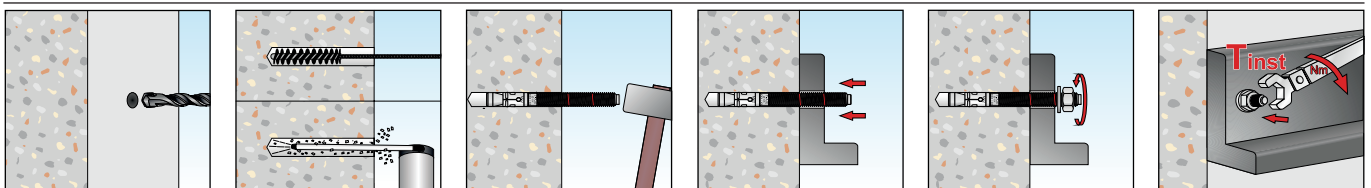

CÓDIGO CODE CODE	MEDIDA SIZE MESURE	BROCA DRILL FORET	PA.	LLAVE KEY CLÉ	ESPESOR A FIJAR THICKNESS TO FIX ÉPAISSEUR	*CMA. EXTRACCIÓN TENSION LOAD	*CMA. CIZALLADO SHEAR LOAD	PROF. TALADRO HOLE DEPTH PROF. TROU			PRECIO TARIFA PRICE LIST PRIX TARIFS
	(MxLt) m.m.	m.m.	(Nm.)	SW	(tfix - tfix,red) m.m.	(kN)	(kN)	m.m.			€/100 u.
SNA4H06060	6x60	6	7	10	2-NA	4,30	2,80	55	100	1.000	176,38
SNA4H06080	6x80	6	7	10	22-NA	4,30	2,80	55	100	1.000	192,41
SNA4H08075	8x75	8	20	13	5-18	5,70	5,10	65	100	500	233,38
SNA4H08090	8x90	8	20	13	20-33	5,70	5,10	65	100	500	277,94
SNA4H10070	10x70	10	35	17	NA-3	6,30	8,10	75	50	250	347,04
SNA4H10090	10x90	10	35	17	10-23	6,30	8,10	75	50	250	413,75
SNA4H10120	10x120	10	35	17	40-53	6,30	8,10	75	50	250	524,57
SNA4H12090	12x90	12	60	19	NA-13	9,90	11,80	85	50	250	596,69
SNA4H12110	12x110	12	60	19	18-33	9,90	11,80	85	25	125	626,75
SNA4H12140	12x140	12	60	19	48-63	9,90	11,80	85	25	125	859,88
SNA4H16145	16x145	16	120	24	23-NA	13,80	22,10	110	20	100	1.622,57
SNA4H16170	16x170	16	120	24	48-NA	13,80	22,10	110	15	75	2.341,75
SNA4H20170	20x170	20	240	30	23-NA	19,80	34,50	135	10	50	4.027,00
SNA4H20220	20x220	20	240	30	73-NA	19,80	34,50	135	5	25	4.111,50

APLICACIÓN

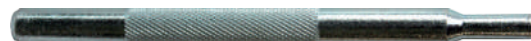

EXPANSIONADOR MANUAL



 MANUAL SETTING TOOL
 OUTIL POUSSOIR
 WERKZEUG FÜR DIE MONTAGE DE DÜBELS, ZU HÄMMERN

CAJA

CÓDIGO CODE CODE	MÉTRICA METRICS MÉTRIQUE			PRECIO TARIFA PRICE LIST PRIX TARIFS
				
m.m.				€/100 u.
EM06	M 6	1	10	612,00
EM08	M 8	1	10	662,00
EM10	M10	1	10	812,13
EM12	M12	1	10	1.107,19
EM16	M16	1	10	1.592,13
EM20	M20	1	10	1.755,54



ANCLAJE HEMBRA SH CINCADO

 ZINC PLATED DROP-IN ANCHOR
 CHEVILLE DE FRAPPE EN ACIER ZINGUÉ
 VERZINKTER DÜBEL MIT INNENKONUS, ZU HÄMMERN



CAJA

CÓDIGO CODE CODE	MÉTRICA METRICS MÉTRIQUE	BROCA DRILL FORET	LARGO LENGTH LONGUEUR	*CMA.			PRECIO TARIFA PRICE LIST PRIX TARIFS
							
m.m.		m.m.	m.m.	(kN)			€/100 u.
SHZ06	M 6	8	25	3,36	100	3.000	12,82
SHZ08	M 8	10	30	4,07	100	1.600	16,38
SHZ10	M10	12	40	4,80	50	800	33,13
SHZ12	M12	15	50	5,82	50	400	50,00
SHZ16	M16	20	65	10,09	25	200	126,88
SHZ20	M20	25	80	15,39	20	200	360,00

AUTOSERVICIO

CÓDIGO CODE CODE	MÉTRICA METRICS MÉTRIQUE			PRECIO TARIFA PRICE LIST PRIX TARIFS
				
m.m.				€/BOLSA
BFSHZ06	M 6	30	12	4,54
BFSHZ08	M 8	30	12	6,00
BFSHZ10	M10	16	12	5,75



BLISTERS

CÓDIGO CODE CODE	MÉTRICA METRICS MÉTRIQUE			PRECIO TARIFA PRICE LIST PRIX TARIFS
				
m.m.				€/BLISTER
BSH06	M 6	4	20	2,89
BSH08	M 8	4	20	2,89
BSH10	M10	2	15	2,89

 PEDIDO MÍNIMO 1 EMBALAJE / MINIMUM ORDER 1 PACKAGING
 COMMANDE MINIMALE 1 EMBALLAGE / MINDESTBESTELLMENGE 1 VERPACKUNG

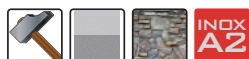
ANCLAJE HEMBRA SH INOXIDABLE A-2

 STAINLESS STEEL AISI 304 DROP IN ANCHOR
 CHEVILLE DE FRAPPE EN ACIER INOX. A-2
 EDELSTAHL A-2 DÜBEL MIT INNENKONUS, ZU HÄMMERN

CAJA

CÓDIGO CODE CODE	MÉTRICA METRICS MÉTRIQUE	BROCA DRILL FORET	LARGO LENGTH LONGUEUR	*CMA.				PRECIO TARIFA PRICE LIST PRIX TARIFS
				EXTRACCIÓN TENSION LOAD EXTRACTION (kN)	CIZALLADO SHEAR LOAD CISAILLEMENT (kN)			
m.m.		m.m.	m.m.					€/100 u.
SHA206	M 6	8	25	1,7	2,0	100	3.000	114,94
SHA208	M 8	10	30	2,7	3,7	100	1.200	161,94
SHA210	M10	12	40	3,5	5,8	50	800	287,29
SHA212	M12	15	50	4,5	8,4	50	400	496,22
SHA216	M16	20	65	6,0	14,6	25	200	1.175,25

ANCLAJE HEMBRA SH INOXIDABLE A-4

STAINLESS STEEL AISI 316 DROP IN ANCHOR
 CHEVILLE DE FRAPPE EN ACIER INOX. A-4
 EDELSTAHL A-4 DÜBEL MIT INNENKONUS, ZU HÄMMERN



CAJA

CÓDIGO CODE CODE	MÉTRICA METRICS MÉTRIQUE m.m.	BROCA DRILL FORET m.m.	LARGO LENGTH LONGUEUR m.m.	*CMA.		PRECIO TARIFA PRICE LIST PRIX TARIFS €/100 u.
				EXTRACCIÓN TENSION LOAD EXTRACTION (kN)	CIZALLADO SHEAR LOAD CISAILLEMENT (kN)	
SHA406	M 6	8	25	1,7	2,0	100 3.000 120,00
SHA408	M 8	10	30	2,7	3,7	100 1.200 180,00
SHA410	M10	12	40	3,5	5,8	50 800 360,00
SHA412	M12	15	50	4,5	8,4	50 400 600,00
SHA416	M16	20	65	6,0	14,6	25 200 1.400,00

AUTOSERVICIO

CÓDIGO CODE CODE	MÉTRICA METRICS MÉTRIQUE m.m.	PRECIO TARIFA PRICE LIST PRIX TARIFS €/BOLSA		
		20	12	
BFSHA406	M 6	20	12	33,85
BFSHA408	M 8	16	12	35,14
BFSHA410	M10	10	12	47,26

PEDIDO MÍNIMO 1 EMBALAJE
 MINIMUM ORDER 1 PACKAGING

TACO PARA PISCINA ESCAMOTEABLE

RETRACTABLE POOL SET
 SET POUR PISCINE ESCAMOTABLE
 SCHWIMMBAD SET EINZIEHBAR



CAJA

CÓDIGO CODE CODE	MEDIDA SIZE MESURE m.m.	BROCA DRILL FORET m.m.	Ø CABEZA Ø HEAD Ø TÊTE m.m.	PRECIO TARIFA PRICE LIST PRIX TARIFS €/100 u.
TPE	M 8	10	14	230,80

INFORMACIÓN TÉCNICA

TPE

INSTALACIÓN

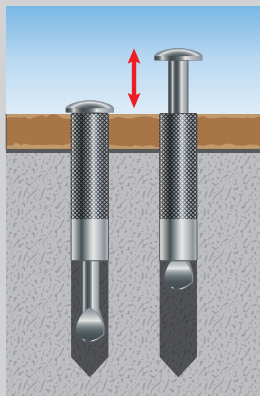

CP / CPM

INSTALACIÓN

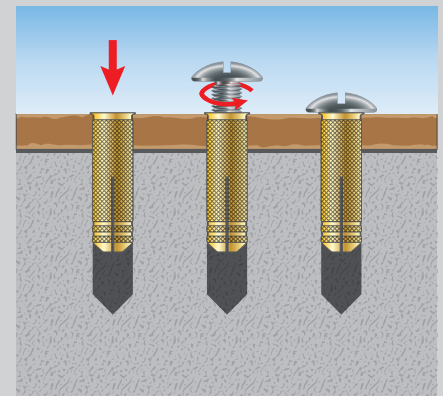

TACO DE LATÓN

KNURLED BRASS ANCHOR
 CHEVILLE EN LAITON MOLETÉ
 GÉRANDELTER DÜBEL AUS MESSING

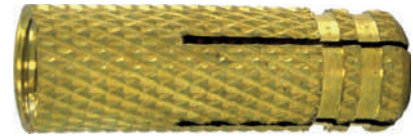

CAJA

CÓDIGO CODE CODE	MÉTRICA METRICS MÉTRIQUE m.m.	BROCA DRILL FORET m.m.	LARGO LENGTH LONGUEUR m.m.	*CMA.		PRECIO TARIFA PRICE LIST PRIX TARIFS €/100 u.
				EXTRACCIÓN TENSION LOAD EXTRACTION (kN)	CIZALLADO SHEAR LOAD CISAILLEMENT (kN)	
TL04	M 4	5	16	2,55	3,06	200 5.000 8,60
TL05	M 5	6,5	20	3,57	4,08	100 5.000 14,85
TL06	M 6	8	24	4,49	5,10	100 5.000 20,07
TL08	M 8	10	28	5,71	7,14	100 2.500 35,32
TL10	M10	12	32	8,98	9,19	100 1.200 56,00

AUTOSERVICIO

CÓDIGO CODE CODE	MEDIDA SIZE MESURE m.m.	PRECIO TARIFA PRICE LIST PRIX TARIFS €/BOLSA
BFTL06	M6 / Ø8	50 12 12,19
BFTL08	M8 / Ø10	30 12 12,97
BFTL10	M10 / Ø12	25 12 17,00

BLISTERS

CÓDIGO CODE CODE	MEDIDA SIZE MESURE m.m.	PRECIO TARIFA PRICE LIST PRIX TARIFS €/BLISTER
BTL05	M5 / Ø6,5	5 25 2,89
BTL06	M6 / Ø8	4 20 2,89
BTL08	M8 / Ø10	4 20 2,89
BTL10	M10 / Ø12	2 15 2,89

TACO DE LATÓN CON COLLARÍN

KNURLED BRASS ANCHOR WITH COLLARD
 CHEVILLE EN LAITON MOLETÉ AVEC COLLERETTE
 GÉRANDELTER DÜBEL AUS MESSING MIT SAUM

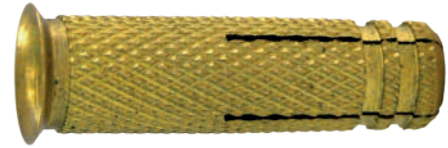

AUTOSERVICIO

CÓDIGO CODE CODE	MEDIDA SIZE MESURE m.m.	PRECIO TARIFA PRICE LIST PRIX TARIFS €/BOLSA

CAJA

CÓDIGO CODE CODE	MEDIDA SIZE MESURE m.m.	PRECIO TARIFA PRICE LIST PRIX TARIFS €/100 u.

CONJUNTO PARA PISCINA

POOL SET / SET POUR PISCINE / SCHWIMMBAD SET



CPM
 TLLO. MEDIA ROSCA
 HALF THREAD / MOITIÉ FILETAGE

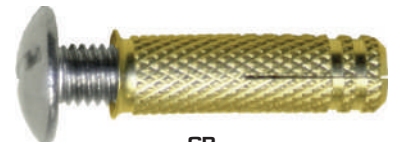

CP
 TLLO. ROSCA COMPLETA
 FULL THREAD / FILETAGE COMPLET

AUTOSERVICIO

CÓDIGO CODE CODE	MEDIDA SIZE MESURE m.m.	PRECIO TARIFA PRICE LIST PRIX TARIFS €/BOLSA

CAJA

CÓDIGO CODE CODE	MEDIDA SIZE MESURE m.m.	PRECIO TARIFA PRICE LIST PRIX TARIFS €/100 u.
CPM	M8x35 / Ø10	100 1.200 134,00

MANGUITO SEPARADOR REDONDO



ROUNDED STEEL COUPLING NUT
 MANCHON CYLINDRIQUE
 RUNDENÜBERWURFMUTTERN





CAJA

CÓDIGO CODE CODE	MEDIDA SIZE MESURE		INOX. A-2	
			PRECIO TARIFA PRICE LIST PRIX TARIFS	€/100 u.
m.m.				
MS206020	6x20 / Ø10	100		84,85
MS206030	6x30 / Ø10	100		111,07
MS208020	8x20 / Ø11	100		125,54
MS208030	8x30 / Ø11	100		156,25
MS210030	10x30 / Ø13	100		187,50



CAJA

CÓDIGO CODE CODE	MEDIDA SIZE MESURE			CINCADO	
				PRECIO TARIFA PRICE LIST PRIX TARIFS	€/100 u.
m.m.					
MS04020	4x20 / Ø8	200	1.200		13,25
MS06020	6x20 / Ø10	200	1.200		13,97
MS06030	6x30 / Ø10	200	1.200		20,75
MS08020	8x20 / Ø11	200	1.200		17,32
MS08030	8x30 / Ø11	200	1.200		21,47
MS10030	10x30 / Ø13	200	1.200		22,85
MS12035	12x35 / Ø15	200	1.200		35,29

AUTOSERVICIO

CÓDIGO CODE CODE	MEDIDA SIZE MESURE			CINCADO	
				PRECIO TARIFA PRICE LIST PRIX TARIFS	€/BOLSA
m.m.					
BFMS04020	4x20 / Ø8	40	12		7,54
BFMS06020	6x20 / Ø10	40	12		9,04
BFMS06030	6x30 / Ø10	40	12		10,07
BFMS08020	8x20 / Ø11	30	12		7,56
BFMS08030	8x30 / Ø11	30	12		9,85
BFMS10030	10x30 / Ø13	20	12		5,47

BLISTERS

CÓDIGO CODE CODE	MEDIDA SIZE MESURE			CINCADO	
				PRECIO TARIFA PRICE LIST PRIX TARIFS	€/BLISTER
m.m.					
BMS0420	4x20 / Ø8	6	15		2,09
BMS0630	6x30 / Ø10	6	15		2,09
BMS0830	8x30 / Ø11	4	15		2,09
BMS1030	10x30 / Ø13	4	15		2,09

PEDIDO MÍNIMO 1 EMBALAJE / MINIMUM ORDER 1 PACKAGING
 COMMANDE MINIMALE 1 EMBALLAGE / MINDESTBESTELLMENGE 1 VERPACKUNG

MANGUITO SEPARADOR HEXAGONAL



HEXAGONAL STEEL COUPLING NUT
 MANCHON HEXAGONAL
 SECHSKANTÜBERWURFMUTTERN





CAJA

CÓDIGO CODE CODE	MEDIDA SIZE MESURE		INOX. A-2	
			PRECIO TARIFA PRICE LIST PRIX TARIFS	€/100 u.
m.m.				
MS206030	6x30 / Ø10	100		125,00
MS208030	8x30 / Ø11	100		174,13
MS210030	10x30 / Ø13	100		206,25



CAJA

CÓDIGO CODE CODE	MEDIDA SIZE MESURE			CINCADO	
				PRECIO TARIFA PRICE LIST PRIX TARIFS	€/100 u.
m.m.					
MSE06020	6x20 / Ø10	200	1.200		15,56
MSE06030	6x30 / Ø10	200	1.200		20,94
MSE08020	8x20 / Ø11	200	1.200		20,97
MSE08030	8x30 / Ø11	200	1.200		23,10
MSE10030	10x30 / Ø13	200	1.200		29,07
MSE12035	12x35 / Ø17	200	1.200		53,07

AUTOSERVICIO

CÓDIGO CODE CODE	MEDIDA SIZE MESURE			CINCADO	
				PRECIO TARIFA PRICE LIST PRIX TARIFS	€/BOLSA
m.m.					
BFMSE06020	6x20 / Ø10	40	12		9,04
BFMSE06030	6x30 / Ø10	40	12		10,07
BFMSE08020	8x20 / Ø11	30	12		6,16
BFMSE08030	8x30 / Ø11	30	12		7,08
BFMSE10030	10x30 / Ø13	20	12		5,47

BLISTERS

CÓDIGO CODE CODE	MEDIDA SIZE MESURE			CINCADO	
				PRECIO TARIFA PRICE LIST PRIX TARIFS	€/BLISTER
m.m.					
BMSE0630	6x30 / Ø10	6	15		2,09
BMSE0830	8x30 / Ø11	6	15		2,09
BMSE1030	10x30 / Ø13	4	15		2,09

PEDIDO MÍNIMO 1 EMBALAJE / MINIMUM ORDER 1 PACKAGING
 COMMANDE MINIMALE 1 EMBALLAGE / MINDESTBESTELLMENGE 1 VERPACKUNG

ANCLAJE TORNILLO GRANDES CARGAS SZ1 - CE OPCIÓN 1

HIGHLOADS STEEL ANCHOR GRADE 8.8 - CE OPT.1
CHEVILLE POUR CHARGES LOURDES CLASSE 8.8 - CE OP.1
SCHWERLASTANKER KLASSE 8.8 - OPT.1



CE OP. 1

CARACTERÍSTICAS, VENTAJAS Y HOMOLOGACIONES

- Tornillo clase 8.8 (ISO 898-1) y arandela de espesor y dureza especiales.
- Acero cincado exento de Cr-VI (conforme ROHS).
- Categoría de prestación C1 para fijaciones en zonas sísmicas, según el ETAG 001 - ANEXO E (Ø16 mm).
- Para fijaciones extra pesadas en hormigón fisurado y no fisurado de clase de resistencia min C20/25 y max C50/60, según el "European Technical Approval".
- Resistencia al fuego R30-R120 según el Technical Report TR 020.
- Fijación pasante.
- Seguridad en el trabajo gracias a la aplicación del par de apriete.
- Tiempo de espera nulo para la aplicación de la carga.
- Utilizable también en hormigón de clase inferior a C20/25 y piedra natural maciza (ambas excepciones no están incluidas en el ETA y, por lo tanto, necesitan de ensayos específicos).

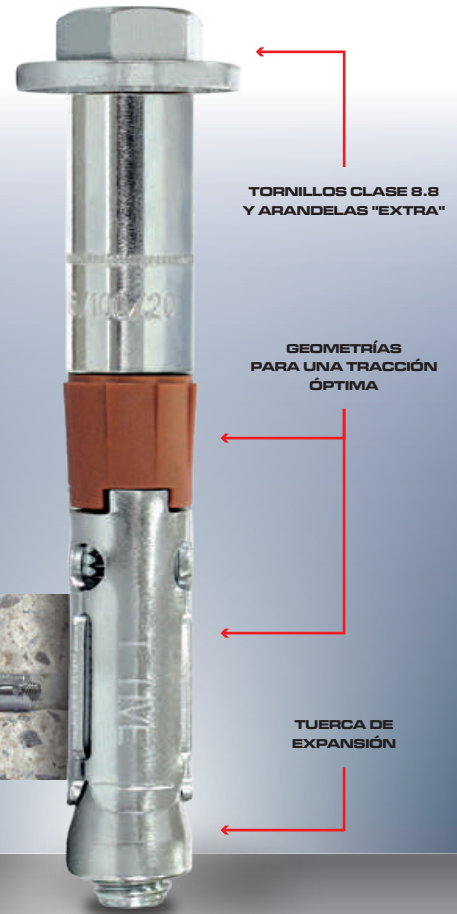

CAJA

CÓDIGO CODE CODE	MEDIDA SIZE MESURE	MÉTRICA METRICS MÉTRIQUE	LLAVE KEY CLÉ	PA.	*CMA. *		CINCO	PRECIO TARIFA PRICE LIST PRIX TARIFS
					EXTRACCIÓN TENSION LOAD EXTRACTION	CIZALLADO SHEAR LOAD CISAILLEMENT		
	ØxL/ℓ _{fix} (m.m.)	m.m.	SW	(Nm.)	(kN)	(kN)	50	€/100 u.
SZ112080	12x80/10	M 8	13	30	10,60	16,66	50	286,16
SZ112100	12x100/30	M 8	13	30	10,60	16,66	25	300,69
SZ112120	12x120/50	M 8	13	30	10,60	16,66	25	343,97
SZ112140	12x140/70	M 8	13	30	10,60	16,66	25	421,79
SZ116100	16x100/20	M10	17	50	13,33	28,66	20	437,38
SZ116120	16x120/40	M10	17	50	13,33	28,66	20	493,88
SZ116140	16x140/60	M10	17	50	13,33	28,66	20	575,66
SZ116160	16x160/80	M10	17	50	13,33	28,66	20	681,16
SZ118120	18x120/20	M12	19	100	23,33	38,66	10	641,79
SZ118150	18x150/50	M12	19	100	23,33	38,66	10	768,35
SZ118170	18x170/70	M12	19	100	23,33	38,66	10	902,82
SZ118200	18x200/100	M12	19	100	23,33	38,66	10	1.182,22
SZ124140	24x140/20	M16	24	160	30,00	71,33	5	1.391,13
SZ124170	24x170/50	M16	24	160	30,00	71,33	5	1.702,66
SZ124200	24x200/80	M16	24	160	30,00	71,33	5	1.965,07
SZ124220	24x220/100	M16	24	160	30,00	71,33	5	2.764,19

APLICACIÓN

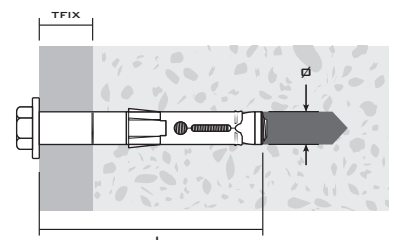
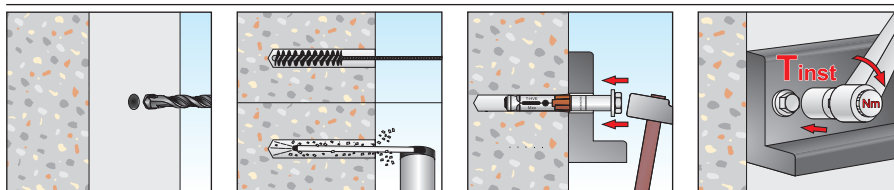



* COEFICIENTE DE SEGURIDAD ETAG INCLUIDO / ETAG SAFETY FACTOR INCLUDED / * COEFFICIENT DE SÉCURITÉ ETAG INCLUS / * SICHERHEITSAKTOR ENTHALTEN ETAG
CMA.: CARGA MÁXIMA ADMISIBLE, PA.: PAR DE APRIETE. / CMA.: MAXIMUM ALLOWABLE LOAD. PA.: TORQUE / CMA.: CHARGE MAXIMALE ADMISIBLE. PA.: COUPLE DE SERRAGE



TORNILLO DIRECTO HORMIGÓN

 DIRECT FIXING SCREW FOR CONCRETE
 VIS DE FIXATION DIRECTE POUR LE BÉTON
 GERADE-BETONSCHRAUBE

CAJA

CÓDIGO CODE CODE	MEDIDA SIZE MEASURE	BROCA DRILL FORET	PROF. TALADRO HOLE DEPTH PROF. TROU	ESPESOR A FIJAR THICKNESS TO FIX ÉPAISSEUR	LLAVE KEY CLÉ			CINCADO	
								PRECIO TARIFA PRICE LIST PRIX TARIFS	€/100 U.
TH075050	7,5x50/47	6	65	10	T-30	100	1.000	15,62	
TH075080	7,5x80/77	6	65	40	T-30	100	1.000	23,32	
TH075090	7,5x90/87	6	65	50	T-30	100	1.000	28,69	
TH075100	7,5x100/97	6	65	60	T-30	100	1.000	36,75	
TH075120	7,5x120/117	6	65	80	T-30	100	1.000	38,94	
TH075135	7,5x135/132	6	65	95	T-30	100	500	42,16	
TH075150	7,5x150/147	6	65	110	T-30	100	500	53,75	
TH075180	7,5x180/177	6	65	140	T-30	100	500	81,32	



AUTOSERVICIO

CÓDIGO CODE CODE	MEDIDA SIZE MEASURE			CINCADO	
				PRECIO TARIFA PRICE LIST PRIX TARIFS	€/BOLSA
BFTH075050	7,5x50	14	12	4,32	
BFTH075080	7,5x80	14	12	4,32	
BFTH075090	7,5x90	12	12	5,96	
BFTH075100	7,5x100	12	12	5,32	

**PEDIDO MÍNIMO 1 EMBALAJE
MINIMUM ORDER 1 PACKAGING**
TORNILLO DIRECTO HORMIGÓN C/PEQUEÑA

 DIRECT FIXING SCREW RED. HEAD FOR CONCRETE
 VIS DE FIXATION DIRECTE TÊTE REDUIT POUR LE BÉTON
 GERADE-BETONSCHRAUBE MIT ZYLINDERKOPF

CAJA

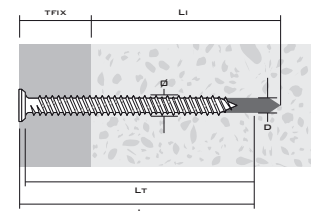
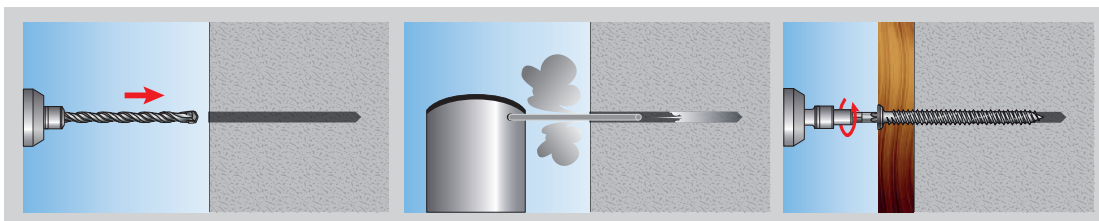

CÓDIGO CODE CODE	MEDIDA SIZE MEASURE	BROCA DRILL FORET	PROF. TALADRO HOLE DEPTH PROF. TROU	ESPESOR A FIJAR THICKNESS TO FIX ÉPAISSEUR	LLAVE KEY CLÉ			CINCADO	
								PRECIO TARIFA PRICE LIST PRIX TARIFS	€/100 U.
THCP75080	7,5x80/77	6	65	40	T-30	100	1.000	23,32	
THCP75090	7,5x90/87	6	65	50	T-30	100	1.000	28,69	
THCP75100	7,5x100/97	6	65	60	T-30	100	1.000	36,75	
THCP75120	7,5x120/117	6	65	80	T-30	100	1.000	38,94	
THCP75135	7,5x135/132	6	65	95	T-30	100	500	42,16	
THCP75150	7,5x150/147	6	65	110	T-30	100	500	53,75	
THCP75180	7,5x180/177	6	65	140	T-30	100	500	81,32	

INFORMACIÓN TÉCNICA - TH / THCP

TORNILLO DIRECTO HORMIGÓN HEXAGONAL



 DIRECT FIXING SCREW FOR CONCRETE WITH HEXAGONAL HEAD
 VIS DE FIXATION DIRECTE POUR LE BÉTON AVEC TÊTE HEXAGONALE
 GERADE-SECHSKANTBETONSCHRAUBE

CAJA

CÓDIGO CODE CODE	MEDIDA SIZE MESURE (\varnothing xL) m.m.	BROCA DRILL FORET (D) m.m.	PROF. TALADRO HOLE DEPTH PROF. TROU (Li) m.m.	ESPESOR A FIJAR THICKNESS TO FIX ÉPAISSEUR (TFIX) m.m.	PA. (Nm.)	LLAVE KEY CLÉ sw	CINCADO		PRECIO TARIFA PRICE LIST PRIX TARIFS €/100 u.
									
THE078060	7,8x60	6	65	10	20	10	100	1.000	51,41
THE078080	7,8x80	6	75	20	20	10	50	500	58,10
THE100060	10x60	8	70	10	50	13	50	500	74,35
THE100080	10x80	8	90	10	50	13	50	500	80,19
THE100100	10x100	8	90	30	50	13	25	250	103,88
THE100140	10x140	8	90	70	50	13	25	250	136,69
THE120070*	12x70	10	85	10	80	15	50	-	142,47
THE120090	12x90	10	100	10	80	15	25	250	168,54
THE120110	12x110	10	100	30	80	15	25	250	200,60
THE120130	12x130	10	100	50	80	15	25	250	249,00
THE120150*	12x150	10	100	70	80	15	25	-	289,44

*HASTA AGOTAR EXISTENCIAS



AUTOSERVICIO

CÓDIGO CODE CODE	MEDIDA SIZE MESURE (\varnothing xL) m.m.	CINCADO		PRECIO TARIFA PRICE LIST PRIX TARIFS €/BOLSA
				
BFTHE075060	7,5x60	10	12	10,51
BFTHE075080	7,5x80	8	12	9,26
BFTHE100060	10x60	8	12	12,05
BFTHE100080	10x80	6	12	9,56
BFTHE100100	10x100	4	12	8,14

**PEDIDO MÍNIMO 1 EMBALAJE
MINIMUM ORDER 1 PACKAGING**
NUEVO PRODUCTO / NEW PRODUCT / NOUVEAU PRODUIT
TORNILLO DIRECTO HORMIGÓN HEXAGONAL INOXIDABLE A-4

 SS. AISI 316 DIRECT FIXING SCREW FOR CONCRETE WITH HEX. HEAD
 FIXATION DIRECTE POUR LE BÉTON AVEC TÊTE HEXAGONALE INOX. A-4
 GERADE-SECHSKANTBETONSCHRAUBE AUS EDELSTAHL A-4

CAJA

CÓDIGO CODE CODE	MEDIDA SIZE MESURE (\varnothing xL) m.m.	BROCA DRILL FORET (D) m.m.	PROF. TALADRO HOLE DEPTH PROF. TROU (Li) m.m.	ESPESOR A FIJAR THICKNESS TO FIX ÉPAISSEUR (TFIX) m.m.	PA. (Nm.)	LLAVE KEY CLÉ sw	INOX. A-4		PRECIO TARIFA PRICE LIST PRIX TARIFS €/100 u.
									
THE408065	8x65	6	70	5	20	10	100	1.000	241,32
THE408080	8x80	6	70	20	20	10	50	500	294,69
THE408100	8x100	6	70	40	20	10	50	500	358,25
THE408140	8x140	6	70	80	20	10	50	500	452,10
THE410080	10x80	8	95	10	50	13	50	500	455,60
THE410100	10x100	8	95	30	50	13	25	250	485,60
THE410140	10x140	8	95	70	50	13	25	250	673,29

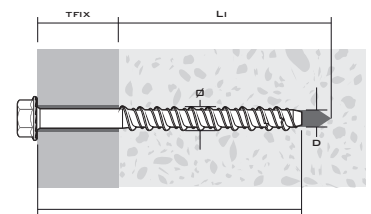
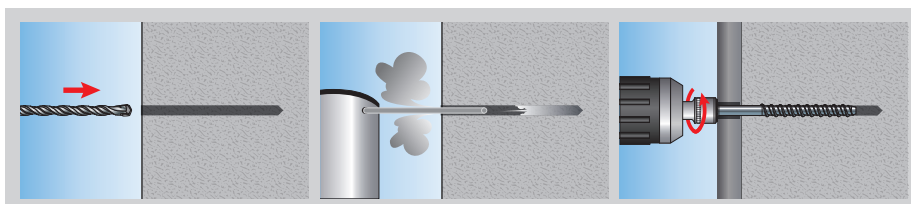
INFORMACIÓN TÉCNICA - THE / THE4

CMA.: CARGA MÁXIMA ADMISIBLE, PA.: PAR DE APRIETE. / CMA.: MAXIMUM ALLOWABLE LOAD, PA.: TORQUE / CMA.: CHARGE MAXIMALE ADMISIBLE, PA.: COUPLE DE SERRAGE

TLLO. DIRECTO HORMIGÓN HEXAGONAL HOMOLOGADO ZN - CE OPCIÓN 1

ZINC PLATED HEX. CONCRETE SCREW - CE OPT.1
 VIS DE FIXATION DIRECTE POUR LE BÉTON AVEC TÊTE HEX. - CE OPT.1
 SECHSKANT-BETONSCHRAUBE VERZINKT - CE OPT.1



CE OP. 1

CARACTERÍSTICAS, VENTAJAS Y HOMOLOGACIONES

- Acero cincado exento de Cr-VI (conforme ROHS).
- Para fijaciones extra pesadas en hormigón fisurado y no fisurado de clase de resistencia min C20/25 y max C50/60, según el "European Technical Approval" (ETA-CE, DoP).
- Resistencia al fuego R30-R120 según el Technical Report TR 020.
- Fijación pasante.
- Control del par de apriete no necesario.
- Tiempo de espera nulo para la aplicación de la carga.
- Utilizable también en hormigón de clase inferior a C20/25 y piedra natural maciza (ambas las excepciones no están incluidas en el ETA y, por lo tanto, necesitan de ensayos específicos).

*** -30% Distancias al borde y entre ejes
 +35% Carga característica de extracción
 +30% Carga característica de corte**

* comparación con anclajes de acero tradicionales de expansión.



ACERO CON TRATAMIENTO ESPECIAL

ROSCA ESPECIAL PARA HORMIGÓN FISURADO Y NO FISURADO

CAJA

CÓDIGO CODE CODE	MEDIDA SIZE MEASURE	BROCA DRILL FORET	PROF. TALADRO HOLE DEPTH PROF. TROU	ESPESOR A FIJAR THICKNESS TO FIX ÉPAISSEUR	PA.	LLAVE KEY CLÉ	CINCO	CINCO
								PRECIO TARIFA PRICE LIST PRIX TARIFS
	m.m.	m.m.	m.m.	m.m.	(Nm.)	SW	50	€/100 U.
THEH08080	8x80	6	80	20	20	10	50	108,91
THEH08100	8x100	6	80	40	20	10	50	117,10
THEH08120	8x120	6	80	60	20	10	50	129,91
THEH08140	8x140	6	80	80	20	10	50	160,63
THEH10080	10x80	8	95	10	50	13	50	161,88
THEH10100	10x100	8	95	30	50	13	25	173,88
THEH10120	10x120	8	95	50	50	13	25	193,82
THEH10140	10x140	8	95	70	50	13	25	208,79
THEH10160	10x160	8	95	90	50	13	25	235,88
THEH12090	12x90	10	110	10	80	15	25	217,75
THEH12110	12x110	10	110	30	80	15	25	239,72
THEH12130	12x130	10	110	50	80	15	25	264,69
THEH12150	12x150	10	110	70	80	15	25	313,00
THEH12190	12x190	10	110	110	80	15	20	440,63
THEH12210	12x210	10	110	130	80	15	20	464,25
THEH12250	12x250	10	110	170	80	15	15	580,54
THEH12290	12x290	10	110	210	80	15	15	679,50

APLICACIÓN

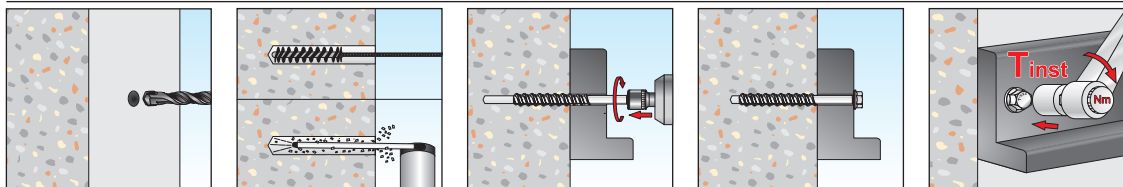

TORNILLO DIRECTO HORMIGÓN CABEZA AVELLANADA ZN - CE OPCIÓN 1

ZINC PLATED FLAT CSK HEAD WITH RIBS CONCRETE SCREW - CE OPT.1
 VIS ZINGUÉ À BÉTON BREVETÉ TÊTE FRAISÉE PLATE - CE OP.1
 SENKKOPF-BETONSCHRAUBE MIT FRÄSRIPPEN, VERZINKT - CE OPT.1

CE OP. 1

CAJA
CINCADO

CÓDIGO CODE CODE	MEDIDA SIZE MEASURE	BROCA DRILL FORET	PROF. TALADRO HOLE DEPTH PROF. TROU	ESPEJOR A FIJAR THICKNESS TO FIX ÉPAISSEUR	PA.	LLAVE KEY CLÉ		PRECIO TARIFA PRICE LIST PRIX TARIFS
	m.m.	m.m.	m.m.	m.m.	(Nm.)			€/100 u.
HXS08070	8x70	6	75	10	20	T-30	100	113,29
HXS08100	8x100	6	75	40	20	T-30	50	135,13
HXS08140	8x140	6	75	80	20	T-30	25	190,44
HXS10080	10x80	8	90	10	50	T-40	50	187,47
HXS10100	10x100	8	90	30	50	T-40	50	199,10
HXS10160	10x160	8	90	90	50	T-40	25	292,04
HXS12100	12x100	10	100	20	80	T-50	25	283,25
HXS12120	12x120	10	100	40	80	T-50	25	306,60
HXS12180	12x180	10	100	100	80	T-50	25	594,88

TORNILLO DIRECTO HORMIGÓN DOBLE ROSCA ZN - CE OPCIÓN 1

ZP. DUAL THREAD CONCRETE SCREW WITH NUT AND WASHER - CE OPT.1
 VIS ZINGUÉ À BÉTON DOUBLE FILETAGE AVEC ÉCROU ET RONDELLE - CE OP.1
 DOPPELGEWINDE-BETONSCHRAUBE MIT MUTTER UND SCHEIBE - CE OPT.1

CE OP. 1

CAJA
CINCADO

CÓDIGO CODE CODE	MEDIDA SIZE MEASURE	BROCA DRILL FORET	PROF. TALADRO HOLE DEPTH PROF. TROU	ESPEJOR A FIJAR THICKNESS TO FIX ÉPAISSEUR	PA.	LLAVE KEY CLÉ		PRECIO TARIFA PRICE LIST PRIX TARIFS
	m.m.	m.m.	m.m.	m.m.	(Nm.)	SW - H		€/100 u.
HXB08090	M-8x90	6	75	10	20	13 - 5	100	193,10
HXB08120	M-8x120	6	75	40	20	13 - 5	100	214,25
HXB08160	M-8x160	6	75	80	20	13 - 5	50	247,82
HXB10105	M-10x105	8	90	10	50	17 - 7	50	254,72
HXB10125	M-10x125	8	90	30	50	17 - 7	50	272,85
HXB10195	M-10x195	8	90	100	50	17 - 7	25	376,04
HXB12118	M-12x118	10	100	10	80	19 - 8	25	356,47
HXB12138	M-12x138	10	100	30	80	19 - 8	25	399,60
HXB12208	M-12x208	10	100	100	80	19 - 8	25	648,13

TLL. DIRECTO HORMIGÓN CABEZA ABOMBADA SST

MUSHROOM HEAD CONCRETE SCREW, SST
 VIS À BÉTON BREVETÉ TÊTE RONDE SST
 RUNDKOPF-BETONSCHRAUBE SST



ACABADO ESPECIAL "STEEL SAVER" 500h
 SPECIAL COATING "STEEL SAVER" 500h

CAJA
SST 500h

CÓDIGO CODE CODE	MEDIDA SIZE MEASURE	BROCA DRILL FORET	PROF. TALADRO HOLE DEPTH PROF. TROU	ESPEJOR A FIJAR THICKNESS TO FIX ÉPAISSEUR	PA.	LLAVE KEY CLÉ		PRECIO TARIFA PRICE LIST PRIX TARIFS
	m.m.	m.m.	m.m.	m.m.	(Nm.)			€/100 u.
HXT08060	8x60	6	65	10	20	T-30	100	63,57
HXT08080	8x80	6	75	20	20	T-30	50	78,35
HXT08100	8x100	6	75	40	20	T-30	50	89,69
HXT08120	8x120	6	75	60	20	T-30	50	117,22
HXT10060	10x60	8	70	10	50	T-40	50	112,32
HXT10080	10x80	8	90	10	50	T-40	50	137,10
HXT10100	10x100	8	90	30	50	T-40	25	156,22
HXT10120	10x120	8	90	50	50	T-40	25	188,54

CÁPSULA METAL + TORNILLO DIN 933

SLEEVE ANCHOR METAL WITH FIXED CONE - SCREW DIN 933
 CHEVILLE À DOUILLE EN ACIER AVEC VIS DIN 933
 HÜLSENANKER MIT SECHSKANTSCHRAUBE DIN 933

CAJA

CÓDIGO CODE CODE	MEDIDA SIZE MESURE	BROCA DRILL FORET	LLAVE KEY CLÉ	*CMA.		100	1.200	PRECIO TARIFA PRICE LIST PRIX TARIFS
				EXTRACCIÓN TENSION LOAD EXTRACTION (kN)	CIZALLADO SHEAR LOAD CISAILLEMENT (kN)			
MCT06	6x45	11	10	9,98	2,60	100	1.200	36,00
MCT08	8x60	14	13	12,50	4,50	50	300	63,00
MCT10	10x70	16	17	20,10	6,10	50	300	98,94
MCT12	12x80	20	19	45,30	10,50	25	150	162,50

CÁPSULA METAL ARO

SLEEVE ANCHOR METAL WITH FIXED CONE - EYE BOLT
 CHEVILLE À DOUILLE EN ACIER AVEC PITON
 HÜLSENANKER MIT AUGENSCHRAUBE

CAJA

CÓDIGO CODE CODE	MEDIDA SIZE MESURE	BROCA DRILL FORET	LLAVE KEY CLÉ	*CMA.		100	600	PRECIO TARIFA PRICE LIST PRIX TARIFS
				EXTRACCIÓN TENSION LOAD EXTRACTION (kN)	CIZALLADO SHEAR LOAD CISAILLEMENT (kN)			
MCA06	6x45	11	10	9,98	2,60	100	600	71,88
MCA08	8x60	14	13	12,50	4,50	50	300	100,00
MCA10	10x70	16	17	20,10	6,10	50	150	153,12
MCA12	12x80	20	19	45,30	10,50	20	120	271,00

CÁPSULA METAL GANCHO

SLEEVE ANCHOR METAL WITH FIXED CONE - HOOK BOLT
 CHEVILLE À DOUILLE EN ACIER AVEC CROCHET
 HÜLSENANKER MIT RUNDHAKEN

CAJA

CÓDIGO CODE CODE	MEDIDA SIZE MESURE	BROCA DRILL FORET	LLAVE KEY CLÉ	*CMA.		100	600	PRECIO TARIFA PRICE LIST PRIX TARIFS
				EXTRACCIÓN TENSION LOAD EXTRACTION (kN)	CIZALLADO SHEAR LOAD CISAILLEMENT (kN)			
MCG06	6x45	11	10	9,98	2,60	100	600	71,88
MCG08	8x60	14	13	12,50	4,50	50	300	100,00
MCG10	10x70	16	17	20,10	6,10	50	150	153,12
MCG12	12x80	20	19	45,30	10,50	20	120	271,00

CÁPSULA METAL

SLEEVE ANCHOR METAL WITH FIXED CONE
 CHEVILLE À DOUILLE EN ACIER
 HÜLSENANKER

CAJA

CÓDIGO CODE CODE	MEDIDA SIZE MESURE	BROCA DRILL FORET	100	1.200	PRECIO TARIFA PRICE LIST PRIX TARIFS
MCO6	6x45	11	100	1.200	25,00
MCO8	8x60	14	50	300	42,00
MC10	10x70	16	50	300	61,35
MC12	12x80	20	25	150	105,32

ZAMAK TORNILLO DIN 933

SLEEVE ANCHOR ZAMAK WITH FIXED CONE AND SCREW DIN 933
 CHEVILLE À DOUILLE ZAMAK AVEC CÔNE FIXE ET VIS DIN 933
 HÜLSENANKER MIT FESTEM KONUS UND SCHRAUBE DIN 933

CAJA

CÓDIGO CODE CODE	MEDIDA SIZE MESURE	BROCA DRILL FORET	LLAVE KEY CLÉ	*CMA.				PRECIO TARIFA PRICE LIST PRIX TARIFS
				EXTRACCIÓN TENSION LOAD EXTRACTION (kN)	CIZALLADO SHEAR LOAD CISAILLEMENT (kN)			
ZT06	6x45	12	10	9,98	2,60	100	1.200	112,59
ZT08	8x60	14	13	12,50	4,50	50	300	150,40
ZT10	10x70	16	17	20,10	6,10	50	300	209,38
ZT12	12x80	20	19	45,30	10,50	25	150	338,00

ZAMAK ARO

SLEEVE ANCHOR ZAMAK WITH FIXED CONE AND EYE
 CHEVILLE À DOUILLE ZAMAK AVEC CÔNE FIXE ET PITON
 HÜLSENANKER MIT FESTEM KONUS UND AUGENSCHRAUBE

CAJA

CÓDIGO CODE CODE	MEDIDA SIZE MESURE	BROCA DRILL FORET	LLAVE KEY CLÉ	*CMA.				PRECIO TARIFA PRICE LIST PRIX TARIFS
				EXTRACCIÓN TENSION LOAD EXTRACTION (kN)	CIZALLADO SHEAR LOAD CISAILLEMENT (kN)			
ZA06	6x45	12	10	9,98	2,60	100	600	134,38
ZA08	8x60	14	13	12,50	4,50	50	300	203,13
ZA10	10x70	16	17	20,10	6,10	50	150	256,25
ZA12	12x80	20	19	45,30	10,50	20	120	442,00

ZAMAK GANCHO

SLEEVE ANCHOR ZAMAK WITH FIXED CONE AND HOOK
 CHEVILLE À DOUILLE ZAMAK AVEC CÔNE FIXE ET CROCHET
 HÜLSENANKER MIT FESTEM KONUS UND RUNDHAKEN

CAJA

CÓDIGO CODE CODE	MEDIDA SIZE MESURE	BROCA DRILL FORET	LLAVE KEY CLÉ	*CMA.				PRECIO TARIFA PRICE LIST PRIX TARIFS
				EXTRACCIÓN TENSION LOAD EXTRACTION (kN)	CIZALLADO SHEAR LOAD CISAILLEMENT (kN)			
ZG06	6x45	12	10	9,98	2,60	100	600	134,38
ZG08	8x60	14	13	12,50	4,50	50	300	203,13
ZG10	10x70	16	17	20,10	6,10	50	150	256,25
ZG12	12x80	20	19	45,30	10,50	20	120	442,00

ZAMAK CÁPSULA

SLEEVE ANCHOR ZAMAK WITH FIXED CONE
 CHEVILLE À DOUILLE ZAMAK AVEC CÔNE FIXE
 HÜLSENANKER MIT FESTEM KONUS

CAJA

CÓDIGO CODE CODE	MEDIDA SIZE MESURE	BROCA DRILL FORET			PRECIO TARIFA PRICE LIST PRIX TARIFS
ZC06	6x45	12	100	1.200	90,63
ZC08	8x60	14	50	300	115,16
ZC10	10x70	16	50	300	156,00
ZC12	12x80	20	25	150	259,00

ANCLAJE EXPANDIBLE PARA CARTÓN-YESO CON TORNILLO COMBI

PLASTERBOARD WALL ANCHOR
CHEVILLE À DOUILLE POUR PLAQUES DE PLÂTRE
HÜLSENANKER FÜR GIPSKARTON



CAJA

CÓDIGO CODE CODE	MEDIDA SIZE MESURE m.m.	LARGO LENGTH LONGUEUR m.m.	Ø BUJE Ø BUSHING Ø BAGUE m.m.	BROCA DRILL FORET m.m.	ESPESOR A FIJAR THICKNESS TO FIX ÉPAISSEUR m.m.	CINCO	PRECIO TARIFA
							PRICE LIST PRIX TARIFS €/100 u.
EXPLATO4032	4x32	32	6,5	8	3-12	100	26,74
EXPLATO4038	4x38	38	6,5	8	10-16	100	28,75
EXPLATO4045	4x45	45	6,5	8	16-22	100	32,50
EXPLATO4054	4x54	54	6,5	8	24-30	100	36,16
EXPLATO5037	5x37	37	8,5	10	6-13	100	44,72
EXPLATO5052	5x52	52	8,5	10	10-16	100	41,69
EXPLATO5065	5x65	65	8,5	10	14-32	100	56,10
EXPLATO6037	6x37	37	10,5	12	6-13	100	47,29
EXPLATO6052	6x52	52	10,5	12	10-16	100	51,88
EXPLATO6065	6x65	65	10,5	12	14-32	100	60,88
EXPLATO6080	6x80	80	10,5	12	20-45	50	90,54

AUTOSERVICIO

CÓDIGO CODE CODE	MEDIDA SIZE MESURE m.m.	CINCO	PRECIO TARIFA PRICE LIST PRIX TARIFS €/BOLSA
BFEXPLAT438	4x38 / Ø8	30 12	8,85
BFEXPLAT445	4x45 / Ø8	30 12	9,00
BFEXPLAT537	5x37 / Ø10	25 12	8,72
BFEXPLAT552	5x52 / Ø10	18 12	7,17
BFEXPLAT637	6x37 / Ø12	20 12	7,94
BFEXPLAT652	6x52 / Ø12	15 12	8,06

APLICACIÓN

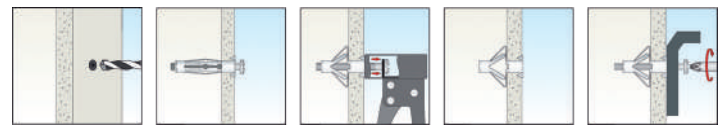

PEDIDO MÍNIMO 1 EMBALAJE / MINIMUM ORDER 1 PACKAGING
COMMANDE MINIMALE 1 EMBALLAGE / MINDESTBESTELLMENGE 1 VERPACKUNG

ALICATES PARA ANCLAJES EN MATERIALES HUECOS

TOOLS FOR HOLLOW WALL ANCHORS INSTALLING
OUTILS POUR LA MISE EN OUVRE DES CHEVILLES POUR MURS VIDES
WERKZEUGE FÜR DIE MONTAGE VON DÜBEL FÜR LEEREN WÄNDEN

CÓDIGO
CODE / CODE



AP

1

PRECIO TARIFA / PRICE LIST
PRIX TARIFS / PREIS TARIF
€/UNIDAD
23,44

PRECIO TARIFA / PRICE LIST
€100 u.
2.343,75



ANCLAJE RESINA POLIESTER - CE OP. 7

POLYESTER RESIN ANCHOR
CHEVILLE RÉSINE POLYESTER
POLIESTERHARZ-ANKER



CE OP. 7



CÁNULA INCLUIDA
STATIC MIXER INCLUDED
CANULE INCLUS

CÓDIGO Code / Code	CONTENIDO CONTENT / CONTENU ml.	
POLI410	410	12
PRECIO TARIFA / PRICE LIST		PRECIO TARIFA / PRICE LIST
€/UNIDAD		€/100 u.
12,67		1.266,67

ANCLAJE RESINA POLIESTER SIN ESTIRENO - CE OP. 7

FREE STYRENE POLYESTER RESIN ANCHOR
CHEVILLE RÉSINE POLYESTER SANS STYRÈNE
POLIESTERHARZ-ANKER STYROLFREI

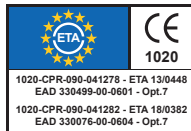

**STYRENE
FREE**

CE OP. 7



CÁNULA INCLUIDA
STATIC MIXER INCLUDED
CANULE INCLUS

CÓDIGO Code / Code	CONTENIDO CONTENT / CONTENU ml.	
POLIS300	300	12
POLIS410	410	12
PRECIO TARIFA / PRICE LIST		PRECIO TARIFA / PRICE LIST
€/UNIDAD	CONTENIDO CONTENT / CONTENU ml.	€/100 u.
13,33	300	1.333,33
14,27	410	1.426,67

ANCLAJE RESINA EPOXYACRILATO - CE OP. 7

EPOXYACRYLATE RESIN ANCHOR
CHEVILLE RÉSINE EPOXYACRYLATE
EPOXIDHARZ-ANKER



CE OP. 7



CÁNULA INCLUIDA
STATIC MIXER INCLUDED
CANULE INCLUS

CÓDIGO Code / Code	CONTENIDO CONTENT / CONTENU ml.	
EPOX300	300	12
EPOX410	410	12
PRECIO TARIFA / PRICE LIST		PRECIO TARIFA / PRICE LIST
€/UNIDAD	CONTENIDO CONTENT / CONTENU ml.	€/100 u.
14,50	300	1.450,00
15,00	410	1.500,00

ANCLAJE RESINA VINILESTER SIN ESTIRENO ECO - CE OP. 7

FREE STYRENE VINYLESTER RESIN ANCHOR
CHEVILLE RÉSINE VINILESTER SANS STYRÈNE
VINILESTERHARZ-ANKER STYROLFREI



STYRENE FREE

CE OP. 7



CÁNULA INCLUIDA
STATIC MIXER INCLUDED
CANULE INCLUS

CÓDIGO Code / Code	CONTENIDO CONTENT / CONTENU ml.	
VINIE410	410	12
PRECIO TARIFA / PRICE LIST		PRECIO TARIFA / PRICE LIST
€/UNIDAD		€/100 u.
16,33		1.633,33

ANCLAJE RESINA VINILESTER SIN ESTIRENO PLUS - CE OP. 1

FREE STYRENE VINYLESTER PLUS RESIN ANCHOR
CHEVILLE RÉSINE VINILESTER PLUS SANS STYRÈNE
VINILESTERPLUS HARZ-ANKER STYROLFREI



STYRENE FREE



CE OP. 1



CÁNULA INCLUIDA
STATIC MIXER INCLUDED
CANULE INCLUS

CARACTERÍSTICAS, VENTAJAS Y HOMOLOGACIONES

- Sistema de anclaje universal universal de alto rendimiento adecuado para su uso en hormigón fisurado y no fisurado en condiciones normales y sísmicas, y en mampostería.
- En marzo de 2016 recibió una ampliación de la **Opción 1 ETA**, con los datos **sísmicos C1** y aprobaciones para resistencia al fuego (F120) y para contacto con agua potable (NSF / ANSI 61).

Aplicaciones Típicas

- Aplicaciones estructurales en hormigón fisurado y no fisurado.
- Barras de refuerzo y amarrque.
- Sistemas de ventilación suspendidos.
- Barreras de seguridad.
- Maquinaria pesada.

CÓDIGO Code / Code	CONTENIDO CONTENT / CONTENU ml.	
VINI410	410	12
PRECIO TARIFA / PRICE LIST		PRECIO TARIFA / PRICE LIST
€/UNIDAD		€/100 u.
18,09		1.808,63

PISTOLAS PARA RESINA - SILICONA (280 - 310 ml.)

HAND GUNS FOR RESIN - SILICONE / PISTOLETS POUR RÉSINE - SILICONE / HANDPISTOLE FÜR HARZ - SILIKON

SKELETON



CÓDIGO CODE / CODE	TAMAÑO SIZE / CALIBRE ml.	
-----------------------	---------------------------------	--

PSS	280 - 310	24
-----	-----------	----

PRECIO TARIFA / PRICE LIST	PRECIO TARIFA / PRICE LIST
€/UNIDAD 9,74	€/100 u. 974,00

GIRATORIA



CÓDIGO CODE / CODE	TAMAÑO SIZE / CALIBRE ml.	
-----------------------	---------------------------------	--

PSG	280 - 310	24
-----	-----------	----

PRECIO TARIFA / PRICE LIST	PRECIO TARIFA / PRICE LIST
€/UNIDAD 18,04	€/100 u. 1.803,13

PISTOLAS PARA RESINA (380 - 410 ml.)

HAND GUNS FOR RESIN / PISTOLETS POUR RÉSINE / HANDPISTOLE FÜR HARZ

ECONÓMICA



CÓDIGO CODE / CODE	TAMAÑO SIZE / CALIBRE ml.	
-----------------------	---------------------------------	--

PRA	380 - 410	12
-----	-----------	----

PRECIO TARIFA / PRICE LIST	PRECIO TARIFA / PRICE LIST
€/UNIDAD 34,38	€/100 u. 3.437,50

GAMA MEDIA



CÓDIGO CODE / CODE	TAMAÑO SIZE / CALIBRE ml.	
-----------------------	---------------------------------	--

PR	380 - 410	12
----	-----------	----

PRECIO TARIFA / PRICE LIST	PRECIO TARIFA / PRICE LIST
€/UNIDAD 60,00	€/100 u. 6.000,00

ELÉCTRICA

NUEVO PRODUCTO / NEW PRODUCT / NOUVEAU PRODUIT



**INCLUYE
MALETÍN**



**NO
GOTEA**

TIPO:	COAXIAL 10:1, 5:1
VELOCIDAD MÁX:	4 mm/sec.
FUERZA MÁX:	600kgf / 6.000N
PESO:	1,5kg

2 BATERÍAS DE LÍTIO DE 7.4V - 1.500mAh

**HASTA 40 TUBOS
CON 1 CARGA**



CÓDIGO CODE / CODE	TAMAÑO SIZE / CALIBRE ml.	
-----------------------	---------------------------------	--

PRBE	380 - 410	1
------	-----------	---

PRECIO TARIFA / PRICE LIST	PRECIO TARIFA / PRICE LIST
€/UNIDAD 781,25	€/100 u. 78.125,00

MALETÍN DE RESINA "TRAILBOX"

TRAILBOX RESIN CASE / MALETTE ET RÉSINE TRAILBOX / TRAILBOX CASE FÜR HARZ

MEDIDAS
SIZE / MESURE:
470 x 290 x 630 MM.
MATERIAL
MATERIAL / MATÉRIEL:
PP



CONTENIDO / CONTENT / CONTENU

QTY.		
1	PISTOLA DE RESINA MOD.: PRA	RESIN HANDGUN MOD.: PRA
12	CARTUCHOS DE RESINA 410ml.	RESIN CARTRIDGES 410ml.
20	TAMICES DE 15x85	SLEEVES 15x85
20	ESPÁRRAGOS DE M-10x110	RODS M-10x110
24	BOQUILLAS	STATIC MIXERS
1	BOMBA DE SOPLADO DE 8"	BLOWER PUMP 8"
3	CEPILLOS (nº1, nº2 y nº3).	BRUSH (nº1, nº2 y nº3).

CÓDIGO CODE / CODE	MODELO MODEL / MODÈLE	PRECIO TARIFA PRICE LIST €/UNIDAD	PRECIO TARIFA PRICE LIST €/100 U.
MPCO	POLIESTER	336,90	33.690,00
MPSC	POLIESTER S/EST.	356,67	35.666,67

MALETÍN DE RESINA PROFESIONAL

PROFESSIONAL RESIN CASE / MALETTE ET RÉSINE PROFESSIONNELLE / PROFESSIONAL CASE FÜR HARZ



CONTENIDO / CONTENT / CONTENU

QTY.		
1	PISTOLA DE RESINA MOD.: PRA	RESIN HANDGUN MOD.: PRA
2	CARTUCHOS DE RESINA 410ml.	RESIN CARTRIDGES 410ml.
10	TAMICES DE 12x80	SLEEVES 12x80
10	ESPÁRRAGOS DE M-8x100	RODS M-8x100
5	BOQUILLAS	STATIC MIXERS

CÓDIGO CODE / CODE	MODELO MODEL / MODÈLE	CANT.	PRECIO TARIFA PRICE LIST €/UNIDAD	PRECIO TARIFA PRICE LIST €/100 U.
MP	POLIESTER 410ML	2	73,34	7.333,34
ME	EPOXYACRILATO 410ML	2	80,00	8.000,00
MPS410	POLIESTER S/EST. 410ML	2	80,00	8.000,00
MPS	POLIESTER S/EST. 300ML	4	80,00	8.000,00
MV	VINILESTER PLUS 410ML	2	93,34	9.333,34

BOQUILLA PARA RESINA



STATIC MIXER FOR CHEMICAL CARTRIDGES / CANULE MÉLANGEUSE POUR RÉSINE / STATISCHE MISCHER FÜR HARZ



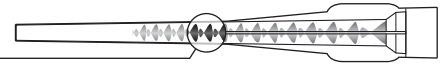

ESPIRAL INTERIOR PARA MEZCLAR
 INNER SPIRAL FOR MIXING
 SPIRALE INTÉRIEURE POUR MÉLANGER



EMBOLSADO

CÓDIGO CODE CODE			PRECIO TARIFA PRICE LIST PRIX TARIFS
8012	12	96	€100 u. 86,67

CAJA

CÓDIGO CODE CODE			PRECIO TARIFA PRICE LIST PRIX TARIFS
80	100	1.000	€100 u. 83,30

CEPILLO LIMPIADOR

BRUSH / BROSSE / KLEIDERBÜRSTE

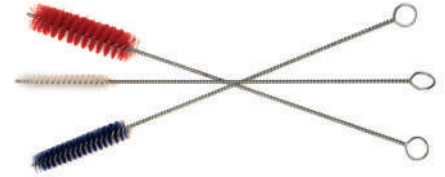



CÓDIGO CODE CODE	MEDIDA SIZE MESURE		PRECIO TARIFA PRICE LIST PRIX TARIFS	PRECIO TARIFA PRICE LIST PRIX TARIFS
	m.m.		€/UNIDAD	€/100 u.
C1	8 - 10	1	8,44	843,75
C2	10 - 14	1	8,44	843,75
C3	16 - 28	1	8,44	843,75

BOMBA DE SOPLADO

BLOWER PUMP / POMPE SOUFFLANTE / AUSBLASPUMPE



CAJA



CÓDIGO CODE CODE	MEDIDA SIZE MESURE			PRECIO TARIFA PRICE LIST PRIX TARIFS	PRECIO TARIFA PRICE LIST PRIX TARIFS
	PULGADAS / INCH.			€/UNIDAD	€/100 u.
BOMBAP	8"	1	24	12,34	1.233,33

ANCLAJE HEMBRA PARA RESINA

STEEL BUSH WITH INTERNAL THREAD FOR CHEMICAL ANCHOR
 MANCHON AVEC FILETAGE INTÉRIEUR POUR ANCRAGE CHIMIQUE
 INNENGEWINDEHÜLSE FÜR CHEMISCHE VERANKERUNG



CAJA

CÓDIGO CODE CODE	MEDIDA SIZE MESURE	BROCA DRILL FORET			CINCADO
	m.m.	m.m.			PRECIO TARIFA PRICE LIST PRIX TARIFS
					€/100 u.
SHR08	8x80	15	50	600	147,00
SHR10	10x80	15	50	600	166,00
SHR12	12x80	20	25	300	190,00

TAMIZ

PERFORATED SLEEVE FOR CHEMICAL ANCHOR
PASSOIRE POUR ANCRAGE CHIMIQUE
SIEBHÜLSE FÜR CHEMISCHE VERANKERUNG

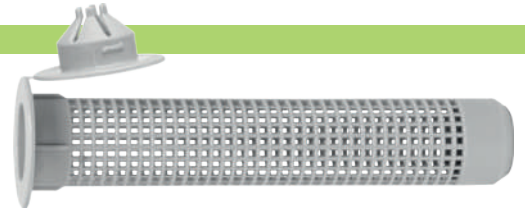
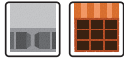

CAJA

*HASTA AGOTAR EXISTENCIAS

CÓDIGO CODE CODE	MEDIDA SIZE MEASURE	BROCA DRILL FORET	MÉTRICA METRICS MÉTRIQUE			PRECIO TARIFA PRICE LIST PRIX TARIFS
	m.m.	m.m.				€/100 u.
TA12050	12x50	12	M6 / M8	100	600	26,67
TA12080	12x80	12	M6 / M8	50	400	26,67
TA15085	15x85	15	M8 / M10 / M12	40	240	26,67
TA15100*	15x100	15	M8 / M10 / M12	40	240	28,50
TA15130	15x130	15	M8 / M10 / M12	30	180	30,00
TA16085	16x85	16	M10 / M12	40	240	26,67
TA16130	16x130	16	M10 / M12	40	240	30,00
TA20085	20x85	20	M14 / M16	25	150	32,00

BLISTERS

CÓDIGO CODE CODE	MEDIDA SIZE MEASURE			PRECIO TARIFA PRICE LIST PRIX TARIFS
	m.m.			€/BLISTER
BTA12080	12x80 / Ø12	4	12	2,89
BTA15085	15x85 / Ø15	2	12	2,89

**PEDIDO MÍNIMO 1 EMBALAJE
MINIMUM ORDER 1 PACKAGING**

TAMIZ ERIZO

"HEDEHOG" PERFORATED SLEEVE FOR CHEMICAL ANCHOR
PASSOIRE "OURSIN" POUR ANCRAGE CHIMIQUE
SIEBHÜLSE FÜR CHEMISCHE VERANKERUNG

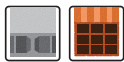

CAJA

CÓDIGO CODE CODE	MEDIDA SIZE MEASURE	BROCA DRILL FORET	MÉTRICA METRICS MÉTRIQUE			PRECIO TARIFA PRICE LIST PRIX TARIFS
	m.m.	m.m.				€/100 u.
TAE13100	13x100	14	M8 / M10	50	400	66,67
TAE15100	15x100	16	M10 / M12	50	300	90,30

VARILLA, TUERCA Y ARANDELA PARA RESINA

ROD, NUT & WASHER FOR CHEMICAL ANCHOR
TIGE FILETÉE, ÉCROU ET RONDELLE POUR ANCRAGE CHIMIQUE
GEWINDESTANGE MIT SECHSKANTMUTTER UND SCHEIBE
FÜR CHEMISCHE VERANKERUNG

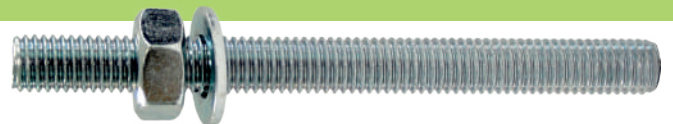

BLISTERS

CÓDIGO CODE CODE	MEDIDA SIZE MEASURE			PRECIO TARIFA PRICE LIST PRIX TARIFS
	m.m.			€/BLISTER
BVRZ08100	8x100	4	12	3,89
BVRZ10110	10x110	2	12	3,89
BVRZ12115	12x115	2	12	3,89

CAJA

CINCADO

CÓDIGO CODE CODE	MEDIDA SIZE MEASURE			PRECIO TARIFA PRICE LIST PRIX TARIFS
	(MxL) m.m.			€/100 u.
VRZ06070	6x70	100	1.200	36,67
VRZ08100	8x100	100	1.200	56,67
VRZ10110	10x110	50	600	70,00
VRZ10140	10x140	50	300	89,00
VRZ12120	12x115	50	300	109,67
VRZ12160	12x160	50	300	170,00



**PEDIDO MÍNIMO 1 EMBALAJE
MINIMUM ORDER 1 PACKAGING**

CAPSULA QUÍMICA ROTACIÓN SQR

SPIN IN CHEMICAL ANCHOR CAPSULE
 SCÉLÈMENT CHIMIQUE PAR AMPOULE DE ROTATION
 VERBUNDANKER



CAJA



CÓDIGO CODE CODE	MÉTRICA METRICS MÉTRIQUE	BROCA DRILL FORET m.m.			PRECIO TARIFA PRICE LIST PRIX TARIFS €/100 u.
					
SQR08	M 8	10	10	200	174,07
SQR10	M10	12	10	200	175,63
SQR12	M12	14	10	200	184,38
SQR16	M16	18	10	200	203,63
SQR20	M20	25	5	40	420,44
SQR24	M24	28	5	40	499,93

ESPÁRRAGO QUÍMICO ROTACIÓN SER CINCADO

ZINC PLATED CHEMICAL ANCHOR STUD 45° SLICED, WITH NUT AND WASHER
 TIGE FILETÉE COUPÉE À 45° AVEC ÉCROU ET RONDELLE EN ACIER ZINGUÉ
 GEWINDESTANGE 45° GESCHNITTEN MIT SCHRAUBENMUTTER UND SCHEIBE



CAJA

CÓDIGO CODE CODE	MEDIDA SIZE MESURE m.m.	BROCA DRILL FORET m.m.	LLAVE KEY CLÉ SW - H			PRECIO TARIFA PRICE LIST PRIX TARIFS €/100 u.
						
SER08110	8x110	10	13 - 5	10	200	105,44
SER10130	10x130	12	17 - 7	10	200	127,57
SER12160	12x160	14	19 - 8	10	200	176,40
SER16190	16x190	18	24 - 12	10	100	308,33
SER20260	20x260	25	30 - NA	5	30	663,33
SER24300	24x300	28	34 - NA	5	10	1.412,87



CINCADO

ESPÁRRAGO QUÍMICO ROTACIÓN SER INOXIDABLE A-4

CHEMICAL ANCHOR STUD 45° SLICED, WITH NUT AND WASHER - SS. AISI 316
 TIGE FILETÉE COUPÉE À 45° AVEC ÉCROU ET RONDELLE - ACIER INOX. A-4
 GEWINDESTANGE 45° GESCHNITTEN MIT SCHRAUBENMUTTER UND SCHEIBE
 EDELSTAHL A-4



CAJA

CÓDIGO CODE CODE	MEDIDA SIZE MESURE m.m.	BROCA DRILL FORET m.m.	LLAVE KEY CLÉ SW - H			PRECIO TARIFA PRICE LIST PRIX TARIFS €/100 u.
						
SER408110	8x110	10	13 - 5	10	200	337,80
SER410130	10x130	12	17 - 7	10	200	503,47
SER412160	12x160	14	19 - 8	10	200	777,80
SER416190	16x190	18	24 - 12	10	100	1.500,00
SER420260	20x260	25	30 - NA	5	30	3.218,27
SER424300	24x300	28	34 - NA	5	10	5.755,07

INOX. A-4

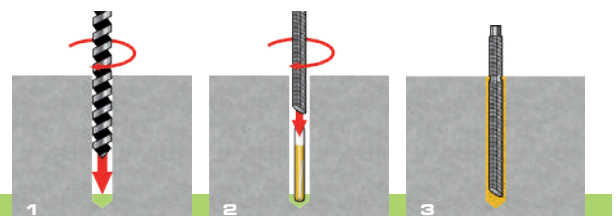

INSTALACIÓN / INSTALLATION

GRAPA VENTILADA INOXIDABLE A-2

STAINLESS STEEL AISI 304 STAPLE
 CRAMPON POUR MORTIER EN ACIER INOX. A-2
 HEFTKLAMMNER AUS EDELSTAHL A-2



PASO 1: PERFORAR LA PARED Y APLICAR LA RESINA
 STEP 1: DRILL THE WALL AND APPLY THE RESIN
 ÉTAPE 1: PERCER LE MUR ET APPLIQUER LA RÉSINE

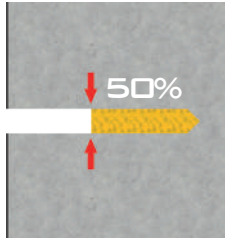

PASO 2: INSERTAR LA GRAPA
 STEP 2: INSERT THE STAPLE
 ÉTAPE 2: INSÉREZ LE CRAMPON

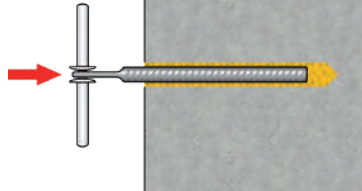

PASO 3: COLOCAR LAS PIEZAS DE LA CUBIERTA
 STEP 3: PLACE THE PIECES OF THE COVER
 ÉTAPE 3: PLACEZ LES PIÈCES DE LA COUVERTURE

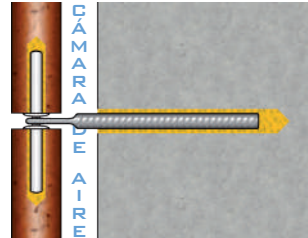

CAJA

INOX. A-2

CÓDIGO CODE CODE	MEDIDA SIZE MESURE	
	m.m.	
GAP08120	8x120	1.000
GAP08130	8x130	1.000
GAP08150	8x150	1.000
GAP08160	8x160	1.000
GAP08180	8x180	1.000
GAP08200	8x200	1.000

CAJA

INOX. A-2

CÓDIGO CODE CODE	MEDIDA SIZE MESURE	
	m.m.	
GAP10120	10x120	1.000
GAP10130	10x130	1.000
GAP10150	10x150	1.000
GAP10160	10x160	1.000
GAP10180	10x180	1.000
GAP10200	10x200	1.000
GAP10220	10x220	1.000

CONSULTAR PRECIO / CHECK PRICE / VÉRIFIER LE PRIX / PREIS PRÜFEN

GRAPA PARA AMORTERAR "Z" INOXIDABLE AISI 302

STAINLESS STEEL AISI 302 STAPLE
 CRAMPON POUR MORTIER EN ACIER INOX. AISI 302
 HEFTKLAMMNER AUS EDELSTAHL AISI 302

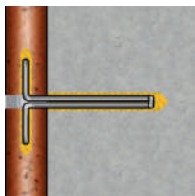

INSTALACIÓN DE LA GAD ENTRE LAS PIEZAS DE LA CUBIERTA

GAS INSTALLING BETWEEN THE PIECES OF THE COVER

INSTALLATION DU GAD ENTRE LES PIÈCES DE LA COUVERTURE

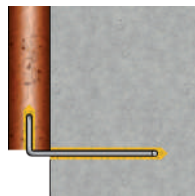

INSTALACIÓN DE LA GAS EN LAS PIEZAS FINALES DE LA CUBIERTA

GAS INSTALLING IN THE FINAL PIECES OF THE COVER

INSTALLATION DU GAS DANS LES DERNIÈRES PIÈCES DE LA COUVERTURE



FABRICADO EN ACERO INOXIDABLE TEMPLADO Y ENDURECIDO PARA OBTENER LA MÁXIMA RESISTENCIA A LA CIZALLADURA.
 MADE OF HARDENED STAINLESS STEEL FOR MAXIMUM SHEAR STRENGTH.
 FABRIQUÉ EN ACIER INOXIDABLE TREMPÉ ET DURCI POUR MAXIMALE RÉSISTANCE DE CISAILEMENT.

CAJA

INOX. AISI 302

CÓDIGO CODE CODE	MODELO MODEL MODÈLE	MEDIDA SIZE MESURE		PRECIO TARIFA PRICE LIST PRIX TARIFS
		m.m.		€/100 u.
GAS	SIMPLE / SINGLE / SIMPLE	2,5x70	1.000	25,93
GAD	DOBLE / DOUBLE / DOUBLE	2,5x70	1.000	42,59

SPRAYS DE GALVANIZADO EN FRÍO - CINCADO / INOXIDABLE

 COLD GALVANIZING SPRAY
 SPRAY POUR GALVANISATION À FROID
 SPRAY FÜR COLD GALVANISIERTEM

SPRAY CINCADO GALVANIZADO

BASE: CINCADO PURO EN UN 98%

COMBUSTIBLE: HIDROCARBURO NATURAL INODORO,
NO TÓXICO, NO CONTIENE CFC

COLOR: CINCADO GRIS

TIEMPO SECADO: SECADO RÁPIDO

EMPLEO: PROTECTOR ANTIOXIDANTE CON UN ELEVADO CONTENIDO DE CINC PARTICULARMENTE ADAPTADO PARA RETOQUES DE LA SOLDADURA, PARA RESTAURAR CHAPAS DE CINC, PARA CINCAR Y PROTEGER PERNOS, TUERCAS QUE ESTÁN A LA INTEMPERIE DURANTE MUCHO TIEMPO, ETC. ESTE PRODUCTO FORMA UNA PELÍCULA DE CINC QUE PRESERVA EL MATERIAL FERROSO DE LA OXIDACIÓN Y PUEDE SER BARNIZADO O DEJADO COMO PROTECCIÓN FINAL. RESISTE A LA SAL POR MUCHAS HORAS. EL SPRAY ESTÁ DOTADO CON UN TAPÓN ANTI-GOTEO QUE EVITA LA SUCIEDAD DURANTE LA UTILIZACIÓN.

SPRAY FOR ZINC PLATED STEEL

BASE: PURE ZINC 98%

FUEL: NATURAL HYDROCARBON ODORLESS,
NON-TOXIC, NO CONTAINS CFC

COLOR: GREY ZINC

DRYING TIME: FAST DRYING

EMPLOYMENT: ANTIOXIDANT PROTECTOR WITH HIGH ZINC CONTENT PARTICULARLY ADAPTED FOR TOUCH-WELDING, TO RESTORE PLATES AND PROTECT BOLTS, NUTS THAT ARE OUTDOORS FOR A LONG TIME. THIS PRODUCT FORMS A ZINC FILM TO PRESERVE THE FERROUS MATERIAL OF THE OXIDATION AND MAY BE PAINTED OR LEFT AS END PROTECTION. RESISTS SALT FOR MANY HOURS. THE SPRAY IS PROVIDED WITH AN ANTI-D RIP CAP PREVENTS DIRT DURING USE.

SPRAY POUR ACIER ZINGUÉ

BASE: ZINGUÉ PURE 98%

CARBURANT: INODORE HYDROCARBURE NATUREL,
NON TOXIQUÉ, NE CONTIENT CFC

COULEUR: ZINGUÉ GRIS

TEMPS SÉCHAGE: SÉCHAGE RAPIDE

EMPLOI: PROTECTEUR ANTI-OXYDANT À HAUTE TENEUR EN ZINC PARTICULIÈREMENT ADAPTÉ POUR TOUCHER SOUDAGE, DE RESTAURER DES PLAQUES DE ZINC POUR LA GALVANISATION ET DE PROTÉGER LES BOULONS, LES ÉCROUS QUI SONT À L'EXTÉRIEUR PENDANT UNE LONGUE PÉRIODE, ETC. CE PRODUIT FORME UN FILM DE ZINC CONSERVE LE MATÉRIAU FERREUX DE L'OXYDATION ET PEUT ÊTRE PEINT OU LAISSÉE TELLE PROTECTION D'EXTRÉMITÉ. RÉSISTE SEL PENDANT PLUSIEURS HEURES. LE PULVÉRISATEUR EST POURVU D'UN CAPUCHON ANTI-GOUTTE EMPÊCHE LA SALETÉ PENDANT L'UTILISATION.



SPRAY ACERO INOXIDABLE

BASE: ACERO INOX EN VEHÍCULO SINTÉTICO

COMBUSTIBLE: HIDROCARBURO NATURAL INODORO,
NO TÓXICO, NO CONTIENE CFC

COLOR: METÁLICO

TIEMPO SECADO: SECADO RÁPIDO

EMPLEO: HIDRÁULICA, CARPINTERÍA METÁLICA, ASTILLEROS, RETOQUES EN GENERAL. PROTECCIÓN GALVÁNICA DE LOS EQUIPOS INDUSTRIALES DE HIERRO, CAÑERÍAS, SOLDADURA DE SUPERFICIES ANTERIORMENTE GALVANIZADAS, DEPÓSITOS, ESTRUCTURAS VARIAS, ESTRUCTURAS MARINAS Y ESTRUCTURAS EN ACERO INOX. FÁCIL APLICACIÓN, SECA RÁPIDAMENTE FORMANDO UNA PELÍCULA FLEXIBLE, COMPACTA Y RESISTENTE QUE PUEDE SER SOBRE BARNIZADA O DEJADA COMO PROTECCIÓN FINAL.

SPRAY FOR STAINLESS STEEL

BASE: STAINLESS STEEL SYNTHETIC VEHICLE

FUEL: NATURAL HYDROCARBON ODORLESS,
NON-TOXIC, NO CONTAINS CFC

COLOR: METALLIC

DRYING TIME: FAST DRYING

EMPLOYMENT: HYDRAULICS, CARPENTRY, SHIPBUILDING, GENERAL TINKERING. GALVANIC PROTECTION FOR INDUSTRIAL EQUIPMENTS, IRON PIPES, SOLDERS IN GALVANIZED SURFACES, TANKS, SEVERAL STRUCTURES, MARINE STRUCTURES AND STRUCTURES IN STAINLESS STEEL. EASY TO APPLY, DRIES QUICKLY FORMING A FLEXIBLE, COMPACT AND RESISTANT FILM WHICH CAN BE PAINTED OR LEFT AS OF END PROTECTION.

SPRAY POUR ACIER INOXIDABLE

BASE: ACIER INOX VÉHICULE SYNTHÉTIQUE

CARBURANT: INODORE HYDROCARBURE NATUREL,
NON TOXIQUÉ, NE CONTIENT CFC

COULEUR: MÉTALLIQUE

TEMPS SÉCHAGE: SÉCHAGE RAPIDE

EMPLOI: HYDRAULIQUE, LA MENUISERIE, LA CONSTRUCTION NAVALE, LE BRICOLAGE EN GÉNÉRAL. PROTECTION GALVANIQUE DE LES ÉQUIPEMENTS INDUSTRIELS, SOUDURE EN SURFACES GALVANISÉES, PLUSIEURS STRUCTURES, LES OUVRAGES MARITIMES ET DES STRUCTURES EN ACIER INOXYDABLE. FACILE À APPLIQUER, SÉCHAGE RAPIDE FORMANT UN FILM SOUPLE, COMPACT ET RÉSISTANT QUI PEUT ÊTRE PEINT OU VERS LA GAUCHE COMME UNE PROTECTION FINAL.



CÓDIGO CODE / CODE	CONTENIDO CONTENT / CONTENU		PRECIO TARIFA PRICE LIST / PRIX TARIFS	
			€/UNIDAD	€/100 U.
SPRAYZ	400 ml.	12	10,11	1.011,00
SPRAYA2	400	12	11,65	1.165,00

ARO ANDAMIO

WELDED EYEBOLT FOR SCAFFOLDS
 PITON POUR FIXATION D'ÉCHAFAUDAGE
 GESCHWEISSTE RINGSCHRAUBE FÜR GERÜSTE



CAJA

CÓDIGO CODE CODE	MEDIDA SIZE MESURE	Ø INT. ARO Ø IN. EYE Ø INT. ANNEAU			PRECIO TARIFA PRICE LIST PRIX TARIFS
	m.m.	m.m.			€/100 u.
AROZ12120	12x120	23	25	100	172,30
AROZ12160	12x160	23	25	100	231,28
AROZ12190	12x190	23	25	100	248,07
AROZ12230	12x230	23	25	100	296,67
AROZ12300	12x300	23	25	100	389,84
AROZ12350	12x350	23	10	60	444,34

TACO NYLON PARA ARO ANDAMIO

NYLON PLUG FOR SCAFFOLDS EYEBOLT
 CHEVILLE NYLON POUR FISATION D'ÉCHAFAUDAGE
 NYLONDÜBEL FÜR GERÜSTE RINGSCHRAUBE

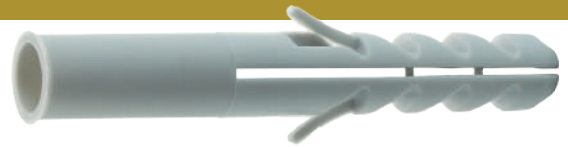
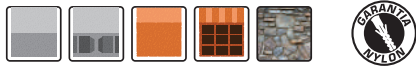

CAJA

CÓDIGO CODE CODE	MEDIDA SIZE MESURE	BROCA DRILL FORET	PROF. TALADRO HOLE DEPTH PROF. TROU			PRECIO TARIFA PRICE LIST PRIX TARIFS
	m.m.	m.m.	m.m.			€/100 u.
TN14100	14x100	14	105	50	300	25,30

TAPÓN DE NYLON PARA ARO ANDAMIO

CAP FOR WALLPLUG
 BOUCHON POUR FORET
 KAPPE FÜR WANDSTECKLÖCHERN



CAJA



CÓDIGO CODE CODE	MEDIDA SIZE MESURE	BROCA DRILL FORET	Ø CABEZA Ø HEAD Ø TÊTE			PRECIO TARIFA PRICE LIST PRIX TARIFS
	m.m.	m.m.	m.m.			€/100 u.
TAA	12x48	14	26	100	600	18,75

FIXBOLT HEMBRILLA RABO DE CERDO

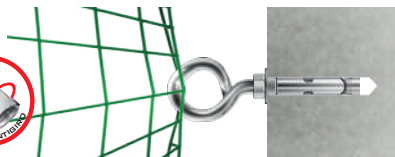
SLEEVE ANCHOR BENT HOOK
 CHEVILLE À DOUILLE AVEC CROCHET PLIÉ
 HÜLSENANKER MIT VERBOGEN-HAKEN



CAJA

CÓDIGO CODE CODE	MEDIDA SIZE MESURE	BROCA DRILL FORET	PA.	LLAVE KEY CLÉ	*CMA.	PROF. TALADRO HOLE DEPTH PROF. TROU			PRECIO TARIFA PRICE LIST PRIX TARIFS
	m.m.	m.m.	(Nm.)	SW	(kN)	m.m.			€/100 u.
FHRC08C	6x45	8	10	10	3,00	60	50	300	CONSULTAR
FHRC10C	8x60	10	25	13	7,00	70	25	150	155,94

FIJACIONES PARA CAPTADORES TÉRMICOS Y FOTOVOLTAICOS

ANCHORS FOR THERMAL COLLECTORS AND PHOTOVOLTAICS MODULES
ANCRAGES POUR CAPTEURS THERMIQUES ET PHANNEAUX PHOTOVOLTAÏQUES
ANKER FÜR THERMISCHE KOLLEKTOREN UND PHOTOVOLTAIK MODULES

LUSAN
SOLAR

CAPTADORES TÉRMICOS Y FOTOVOLTAICOS



ANCLAJE PARA TEJA INOX. A2 10x200 mm



CÓDIGO CODE CODE	MEDIDA SIZE MEASURE	BROCA DRILL FORET
CESA2	m.m. 10x200	m.m. 10



ANCLAJE HORMIGÓN INOX. A2 10x150 mm



CÓDIGO CODE CODE	MEDIDA SIZE MEASURE	BROCA DRILL FORET
FES212C	m.m. 10x150	m.m. 12

CONSULTAR PRECIO / CHECK PRICE / VÉRIFIER LE PRIX / PREIS PRÜFEN

SALVATEJAS

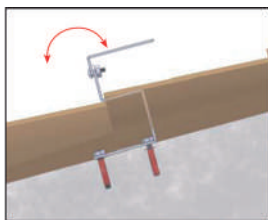
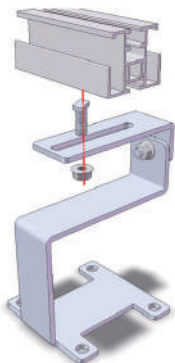

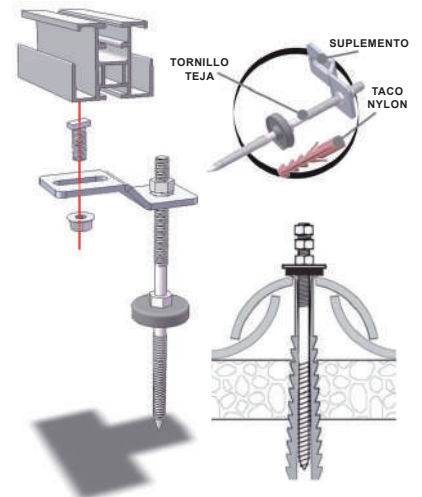
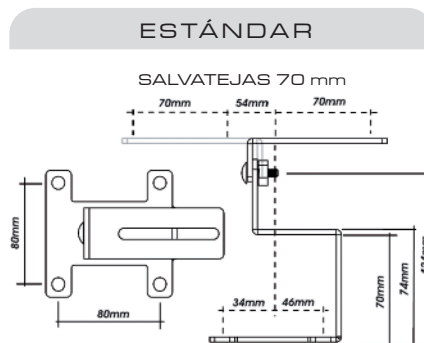

Los salvatejas disponen de un juego de 200 mm para poder salvar la teja sin tener que mecanizarla.



BRIDAS DE NYLON POLYAMIDA 6.6 EN BLANCO Y NEGRO

 BLACK & WHITE NYLON CABLE TIES
 COLLIERS DE SERRAGE EN NYLON, BLANC ET NOIR
 KABELBINDER AUS NYLON, WEISS UND SCHWARZ

BOLSA

*CÓDIGO *CODE *CODE	MEDIDA SIZE MESURE	Ø MÁX. CIERRE Ø MAX. CLOSURE Ø MAX. FERMETURE			PRECIO TARIFA PRICE LIST PRIX TARIFS
	m.m.	m.m.			€/100 U.
BB/BN/0250098	2,5x98	21	100	30.000	0,91
BB/BN/0260135	2,6x135	32	100	25.000	1,75
BB/BN/0260160	2,6x160	40	100	20.000	1,98
BB/BN/0260200	2,6x200	52	100	20.000	2,41
BB/BN/0360140	3,6x140	35	100	30.000	2,27
BB/BN/0360200	3,6x200	50	100	12.000	3,22
BB/BN/0360290	3,6x290	80	100	13.000	4,35
BB/BN/0360370	3,6x370	103	100	8.000	8,25
BB/BN/0450120	4,5x120	40	100	25.000	3,22
BB/BN/0450160	4,5x160	24	100	10.000	4,16
BB/BN/0480178	4,8x178	45	100	10.000	3,63
BB/BN/0480200	4,8x200	50	100	10.000	3,69
BB/BN/0480250	4,8x250	68	100	10.000	5,57
BB/BN/0480290	4,8x290	79	100	10.000	6,19
BB/BN/0480360	4,8x360	103	100	8.000	8,07
BB/BN/0480430	4,8x430	115	100	5.000	12,94
BB/BN/0780180	7,8x180	45	100	5.000	10,94
BB/BN/0780240	7,8x240	63	100	4.000	13,75
BB/BN/0780300	7,8x300	80	100	4.000	13,85
BB/BN/0780365	7,8x365	100	100	3.000	15,55
BB/BN/0780450	7,8x450	130	100	2.500	26,50
BB/BN/0780540	7,8x540	130	100	2.500	34,35
BB/BN/0780750	7,8x750	200	100	1.500	43,16
BB/BN/0900780	9,0x780	233	50	1.000	54,25
BB/BN/0901220	9,0x1.220	375	50	1.000	101,04
BB/BN/1260500	12,6x500	143	50	1.000	55,41
BB/BN/1260720	12,6x720	213	50	1.000	69,63
BB/BN/1260850*	12,6x850	255	50	1.000	90,00
BB/BN/1261000	12,6x1.000	302	50	1.000	100,94

*HASTA AGOTAR EXISTENCIAS

AUTOSERVICIO

*CÓDIGO *CODE *CODE	MEDIDA SIZE MESURE		PRECIO TARIFA PRICE LIST PRIX TARIFS
	m.m.		€/EMBALAJE
BBE/BNE/0250098	2,5x98	3.000	28,07
BBE/BNE/0260135	2,6x135	3.000	48,07
BBE/BNE/0260160	2,6x160	2.000	36,72
BBE/BNE/0260200	2,6x200	2.000	53,75
BBE/BNE/0360140	3,6x140	2.000	45,32
BBE/BNE/0360200	3,6x200	2.000	59,07
BBE/BNE/0360290	3,6x290	1.000	48,44
BBE/BNE/0360370	3,6x370	1.000	73,44
BBE/BNE/0450120	4,5x120	2.000	65,60
BBE/BNE/0450160	4,5x160	2.000	70,94

AUTOSERVICIO

*CÓDIGO *CODE *CODE	MEDIDA SIZE MESURE		PRECIO TARIFA PRICE LIST PRIX TARIFS
	m.m.		€/EMBALAJE
BBE/BNE/0480178	4,8x178	2.000	73,44
BBE/BNE/0480200	4,8x200	2.000	75,44
BBE/BNE/0480250	4,8x250	2.000	112,50
BBE/BNE/0480290	4,8x290	1.000	62,47
BBE/BNE/0480360	4,8x360	1.000	78,13
BBE/BNE/0780180	7,8x180	1.000	90,63
BBE/BNE/0780240	7,8x240	1.000	107,41
BBE/BNE/0780300	7,8x300	1.000	124,29
BBE/BNE/0780365	7,8x365	800	124,29

**PEDIDO MÍNIMO 1 EMBALAJE / MINIMUM ORDER 1 PACKAGING
 COMMANDE MINIMALE 1 EMBALLAGE / MINDESTBESTELLMENGE 1 VERPACKUNG**

BRIDAS DE NYLON POLYAMIDA 6.6 DE COLOR

COLOURED NYLON CABLE TIES
COLLIERS DE SERRAGE DE COULEURS
FARBIGE KABELBINDER



BOLSA

MEDIDA SIZE MEASURE	*COLORES DISPONIBLES *AVAILABLE COLOURS *COULEURS DISPONIBLES			PRECIO TARIFA PRICE LIST PRIX TARIFS
m.m.				€/100 u.
2,5x98		100	5.000	1,28
3,6x140		100	5.000	3,29
3,6x200		100	5.000	5,14
4,8x200		100	5.000	5,75
4,8x290		100	5.000	8,63

AUTOSERVICIO

MEDIDA SIZE MEASURE		PRECIO TARIFA PRICE LIST PRIX TARIFS
m.m.		€/EMBALAJE
2,5x98	3.000	39,94
3,6x140	2.000	68,75
3,6x200	2.000	88,44
4,8x200	2.000	109,07
4,8x290	1.000	90,32

RAL	Código / Code	COLOR / COLOUR / COULEUR
	RAL 5010 BZ / BZE	AZUL / BLUE / BLEU
	RAL 3000 BR / BRE	ROJO / RED / ROUGE
	RAL 6032 BV / BVE	VERDE / GREEN / VERT
	RAL 1021 BA / BAE	AMARILLO / YELLOW / JAUNE
	RAL 7035 BG / BGE	GRIS / GRAY / GRIS

PEDIDO MÍNIMO 1 EMBALAJE / MINIMUM ORDER 1 PACKAGING
COMMANDE MINIMALE 1 EMBALLAGE / MINDESTBESTELLMENGE 1 VERPACKUNG

EXPOSITORES PARA BRIDAS

PAG.: 184 - 186

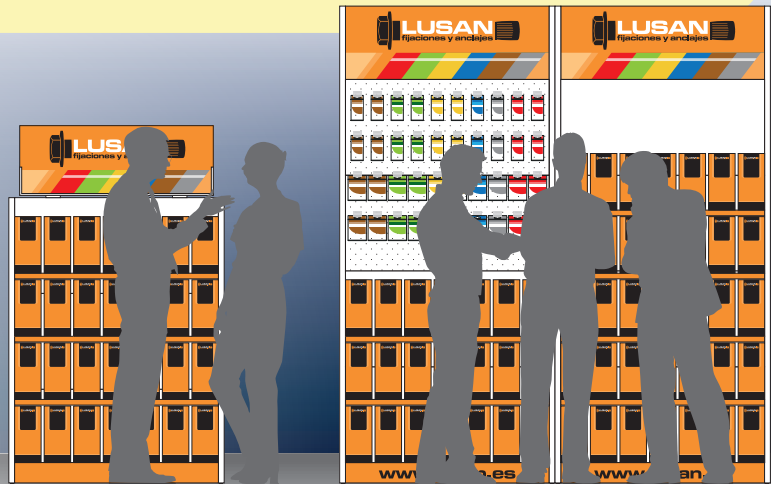

**NUEVO EMPAQUETADO
AUTOSERVICIO**

* LOS COLORES IMPRESOS AQUÍ SON APROXIMADOS, PARA SOLICITAR MUESTRAS CONTACTE CON NOSOTROS. / PRINTED COLORS HERE ARE APPROXIMATE, TO REQUEST SAMPLES CONTACT US.
LES COULEURS IMPRIMÉES ICI SONT APPROXIMATIVES, POUR COMMANDER DES ÉCHANTILLONS CONTACTEZ-NOUS.

BRIDAS DE NYLON RECUPERABLES EN BLANCO Y NEGRO

 NYLON RECOVERABLE CABLE TIES
 COLLIERS RÉCUPÉRABLES EN NYLON
 LÖSBARE KABELBINDER AUS NYLON



MEDIDAS / SIZES / MESURES:

- 3,5x250
- 3,5x280



MEDIDAS / SIZES / MESURES:

- 7,5x250
- 7,5x360



BOLSA

*CÓDIGO *CODE *CODE	MEDIDA SIZE MESURE	Ø MÁX. CIERRE Ø MAX. CLOSURE Ø MAX. FERMETURE			PRECIO TARIFA PRICE LIST PRIX TARIFS
	(AxD) m.m.	m.m.			€/100 u.
BRB/BRN/35250	3,5x250	68	100	13.000	7,09
BRB/BRN/35280	3,5x280	80	100	13.000	8,15
BRB/BRN/75250	7,5x250	65	100	5.000	17,06
BRB/BRN/75360	7,5x360	100	100	3.000	23,59

AUTOSERVICIO

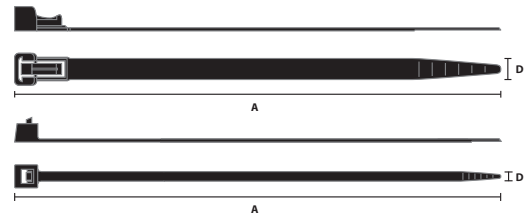
*CÓDIGO *CODE *CODE	MEDIDA SIZE MESURE		PRECIO TARIFA PRICE LIST PRIX TARIFS
	(AxD) m.m.		€/EMBALAJE
BRNE/BRBE/35250	3,5x250	1.000	65,32
BRNE/BRBE/35280	3,5x280	1.000	68,50
BRNE/BRBE/75250	7,5x250	1.000	140,25
BRNE/BRBE/75360	7,5x360	800	145,32

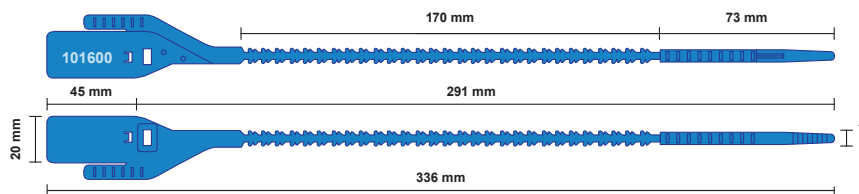

PEDIDO MÍNIMO 1 EMBALAJE / MINIMUM ORDER 1 PACKAGING
COMMANDE MINIMALE 1 EMBALLAGE / MINDESTBESTELLMENGE 1 VERPACKUNG
BRIDAS DE SEGURIDAD DE POLIPROPILENO

 POLYPROPYLENE TAMPER EVIDENT SEALS
 SCÉLLÉS DE SÉCURITÉ EN POLYPROPILÈNE
 SICHERUNGSPLOMBE AUS POLYPROPYLEN

BRIDA NEUTRA CODIFICADA

 BRIDA PERSONALIZADA
 (OPCIONAL / OPTIONAL)

CAJA

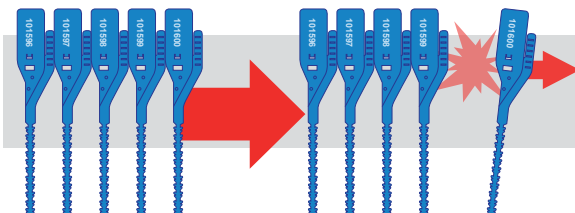

CÓDIGO CODE CODE	MODELO MODEL MODÈLE	*COLOR *COLOR *COULEUR	MEDIDA SIZE MESURE		PRECIO TARIFA PRICE LIST PRIX TARIFS
			m.m.		€/100 u.
BS	NEUTRA CODIFICADA	AZUL / BLUE / BLEU	6,6x336	300	32,44
BSP	PERSONALIZADA	AZUL / BLUE / BLEU	6,6x336	300	CONSULTAR

MÉTODO DE SEPARACIÓN DEL MÓDULO DE 5 UNIDADES: SE DEBE ASIR EL PRECINTO POR LA PARTE MOLETEADA Y TIRAR HACIA AFUERA.
PARTING FROM THE 5 PIECES MODULE: THE SEAL IS GRIPPED ON THE KNURLING SIDE AND IT IS PULLED OUTWARDLY.
MODALITÉS D'OUVERTURE DU SCÉLLÉ APRÈS APPLICATION: ARRACHER LA LANGUETTE VERS LE HAUT EN GARDANT TOURNÉE VERS LE HAUT LA FACE DE L'ÉTIQUETTE DU SCÉLLÉ SUR LAQUELLE SE TROUVE LA PARTIE EN SAILLIE.



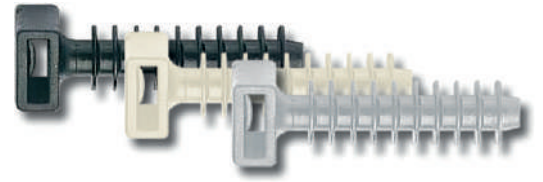
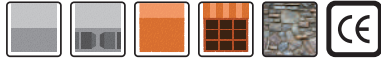

MÉTODO DE APERTURA DEL PRECINTO DESPUÉS DE LA APLICACIÓN: DESGARRE LA LENGÜETA HACIA ARRIBA, RETENIENDO LA ETIQUETA DEL PRECINTO CON LA CARA, DONDE APARECE LA PARTE SALIENTE, DIRIGIDA HACIA ARRIBA.
SEAL OPENING AFTER THE INSTALLATION: TEAR THE TONGUE OFF UPWARDS KEEPING THE LABEL OF THE SEAL UPWARDS WHERE THE PROMINENT SIDE APPEARS.
MODALITÉS D'OUVERTURE DU SCÉLLÉ APRÈS APPLICATION: ARRACHER LA LANGUETTE VERS LE HAUT EN GARDANT TOURNÉE VERS LE HAUT LA FACE DE L'ÉTIQUETTE DU SCÉLLÉ SUR LAQUELLE SE TROUVE LA PARTIE EN SAILLIE.

TACO FIJACIÓN PARA BRIDAS DE NYLON

 NYLON CABLE TIES WALL PLUG
 TAQUET POUR COLLIER EN NYLON
 NYLONDÜBEL FÜR KABELBINDER

CAJA

CÓDIGO CODE CODE	MEDIDA SIZE MEASURE m.m.	*COLOR *COLOR *COULEUR	BROCA DRILL FORET m.m.			PRECIO TARIFA PRICE LIST PRIX TARIFS €/100 u.
TB6	∅6 (7,8x37)	NEGRO / BLACK / NOIR	6	100	5.000	5,47
TB8	∅8 (9x43,5)	NEGRO / BLACK / NOIR	8	100	5.000	5,47
TB88	∅8 (9x43,5)	BLANCO / WHITE / BLANC	8	100	5.000	5,47
TB88	∅8 (9x43,5)	GRIS / GRAY / GRIS	8	100	5.000	6,00



AUTOSERVICIO

CÓDIGO CODE CODE	MEDIDA SIZE MEASURE m.m.		PRECIO TARIFA PRICE LIST PRIX TARIFS €/EMBALAJE
TBNE6	∅6 (7,8x37)		1.000 54,69
TBNE8	∅8 (9x43,5)		1.000 54,69
TBGE8	∅8 (9x43,5)		1.000 54,69
TBBE8	∅8 (9x43,5)		1.000 54,69

**PEDIDO MÍNIMO 1 EMBALAJE
MINIMUM ORDER 1 PACKAGING**
BASE ADHESIVA PARA BRIDAS DE NYLON

 NYLON SQUARE BASE WITH DUAL-ADHESIVE
 EMBASE CARRÉE EN NYLON AVEC BI-ADHESIVE
 MONTAGESOCKEL VIERECKIG AUS NYLON GERICHTET MIT KLEBESTREIFEN

BOLSA

CÓDIGO CODE CODE	MEDIDA SIZE MEASURE m.m.	*COLOR *COLOR *COULEUR	ANCHO BRIDA TIE WIDTH LARGEUR COLLIER m.m.			PRECIO TARIFA PRICE LIST PRIX TARIFS €/100 u.
BASEADB19	19x19	BLANCO / WHITE / BLANC	4	100	3.000	18,44
BASEADN19	19x19	NEGRO / BLACK / NOIR	4	100	3.000	18,44
BASEADB27	27x27	BLANCO / WHITE / BLANC	4,8	100	3.000	28,13
BASEADN27	27x27	NEGRO / BLACK / NOIR	4,8	100	3.000	28,13

TENSOR DE BRIDAS

COLLAR FASTENING METAL PLIER / TENSEUR DE COLLIER DE SERRAGE / KABELSCHELLENZANGE AUS METAL

CÓDIGO CODE / CODE	ANCHO MÁX. BRIDA MAX. CABLE TIE WIDTH m.m.	GROSOR MÁX. BRIDA MAX. CABLE TIE THICK. m.m.	
TENSORE	9,5	2,3	1

PRECIO TARIFA / PRICE LIST

€/UNIDAD

46,88

PRECIO TARIFA / PRICE LIST

€/100 u.

4.687,50



BRIDAS DE NYLON PARA TUBO

NYLON PIPE FLANGE
COLLIERS DE TUBE EN NYLON
ROHRFLANSCH AUS NYLON



BOLSA

CÓDIGO CODE CODE	DESCRIPCIÓN DESCRIPTION DESCRIPTION	MEDIDA SIZE MESURE	TUBO PIPE TUBE			PRECIO TARIFA PRICE LIST PRIX TARIFS
		m.m.	m.m.			€/100 u.
BT	BRIDA NYLON PARA TUBO	7x165	16 - 32	100	2.000	29,16
TBR	TACO BRIDA PARA TUBO	M 7 - Ø 8	-	100	2.000	11,80

AUTOSERVICIO

CÓDIGO CODE CODE	MEDIDA SIZE MESURE		PRECIO TARIFA PRICE LIST PRIX TARIFS
	m.m.		€/EMBALAJE
BTE	7x165	600	169,69
TBRE	M 7 - Ø 8	1.000	80,00

**PEDIDO MÍNIMO 1 EMBALAJE
MINIMUM ORDER 1 PACKAGING**

INSTALACIÓN

- Introducir a golpe el taco brida dejando la rosca superior visible.
- Roscar la brida para tubo en el taco hasta quedar bien sujeta.
- Colocar el tubo ajustando la brida y cortando la parte restante.

INSTALLATION

- Plug-in installation leaving the top thread visible.
- Screw the pipe flange on the stud to be secure.
- Place the tube adjusting the tie and cutting the rest.

INSTALLATION

- Entrez un coup le tacet de collier laissant le fil supérieur visible.
- Visser le collier sur le tacet pour être sûr.
- Placer le tube ajustant le collier et couper le reste

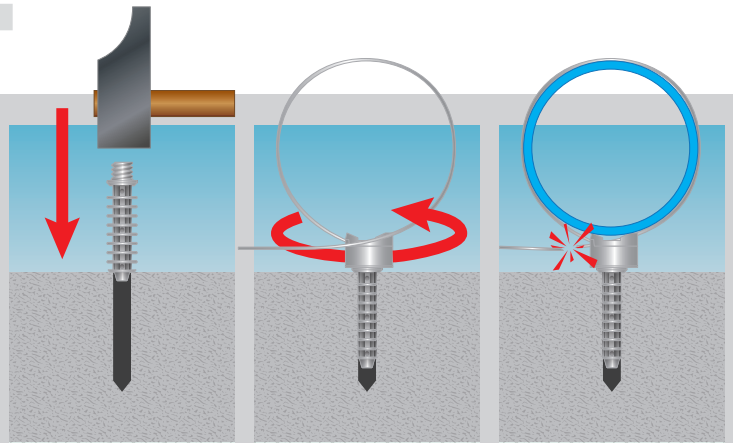

ABRAZADERA DE NYLON UNIVERSAL

UNIVERSAL NYLON PIPE FLANGE
COLLIERS DE TUBE UNIVERSEL EN NYLON
UNIVERSAL ROHRFLANSCH AUS NYLON



- COBRE / COOPER
- PLÁSTICO / PLASTIC



CAJA

CÓDIGO CODE / CODE	CÓDIGO CODE / CODE	Ø TUBO / PIPE / TUBE				PRECIO TARIFA PRICE LIST PRIX TARIFS
BLANCO WHITE / BLANC	GRIS GREY / GRIS					€/100 u.
		m.m.	m.m.			
ANU1518	ANUG1518	15-18	15-18	100	600	23,97
ANU2025	ANUG2025	22	20-25	50	300	36,50
ANU2532	ANUG2532	28	25-32	50	200	39,82

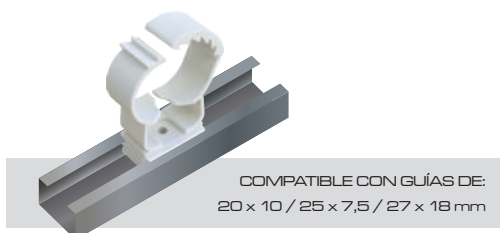

**INSTALACIÓN
RÁPIDA**

**QUICK
INSTALLATION**

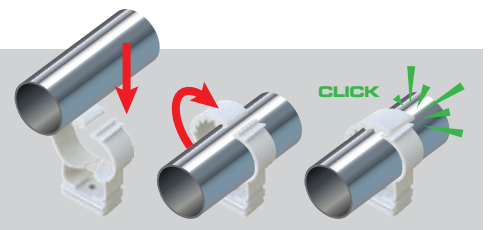



* LOS COLORES IMPRESOS AQUÍ SON APROXIMADOS, PARA SOLICITAR MUESTRAS CONTACTE CON NOSOTROS. / PRINTED COLORS HERE ARE APPROXIMATE, TO REQUEST SAMPLES CONTACT US.
LES COULEURS IMPRIMÉES ICI SONT APPROXIMATIVES, POUR COMMANDER DES ÉCHANTILLONS CONTACTEZ-NOUS.



ABRAZADERA DE NYLON "LUXRING"

 PIPES NYLON WALL PLUG
 TAQUET POUR TUBES EN NYLON
 NYLONDÜBEL FÜR ROHRE



CAJA
SIMPLE / SIMPLE / SIMPLE

CÓDIGO CODE CODE	Ø TUBO PIPE Ø Ø TUBE	Ø-L BROCA DRILL Ø-L Ø-L FORET			PRECIO TARIFA PRICE LIST PRIX TARIFS
					
	m.m.	m.m.			€/100 u.
LUXRING14	14	Ø8 - 30	100	1.600	23,22
LUXRING16	16	Ø8 - 30	100	1.600	24,04
LUXRING18	18	Ø8 - 30	100	1.600	24,82
LUXRING20	20	Ø8 - 30	100	1.600	26,17
LUXRING22	22	Ø8 - 30	100	1.600	26,85
LUXRING25	25	Ø8 - 30	100	1.200	27,66
LUXRING28	28	Ø8 - 30	100	1.200	33,22
LUXRING32	32	Ø8 - 30	50	800	40,88

CAJA
DOBLE / DOUBLE / DOUBLE

CÓDIGO CODE CODE	Ø TUBO PIPE Ø Ø TUBE	Ø-L BROCA DRILL Ø-L Ø-L FORET			PRECIO TARIFA PRICE LIST PRIX TARIFS
					
	m.m.	m.m.			€/100 u.
LUXRINGD16	16	Ø8 - 30	100	1.200	28,33
LUXRINGD18	18	Ø8 - 30	100	1.200	32,16
LUXRINGD20	20	Ø8 - 30	100	1.200	32,97
LUXRINGD22	22	Ø8 - 30	100	900	34,82
LUXRINGD25	25	Ø8 - 30	100	900	38,29
LUXRINGD28	28	Ø8 - 30	50	600	49,50

CAJA
CUÁDRUPLE / QUADRUPLE / QUADRUPLE

CÓDIGO CODE CODE	Ø TUBO PIPE Ø Ø TUBE	Ø-L BROCA DRILL Ø-L Ø-L FORET			PRECIO TARIFA PRICE LIST PRIX TARIFS
					
	m.m.	m.m.			€/100 u.
LUXRINGQ20	20	Ø8 - 30	50	600	55,94
LUXRINGQ25	25	Ø8 - 30	50	450	68,75

INSTALACIÓN

Perforar / Drill

Golpear / Hit

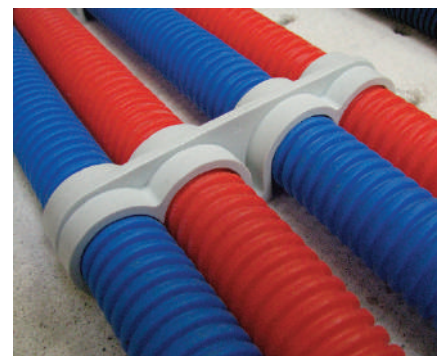
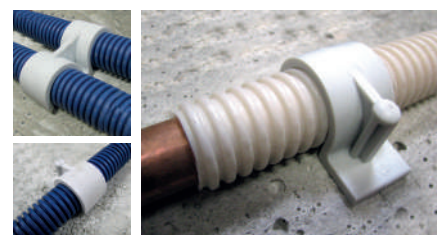
Listo / Ready

CARACTERÍSTICAS Y VENTAJAS

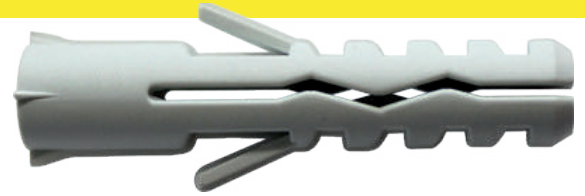
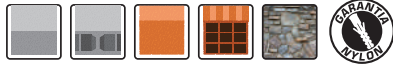

- Para la fijación de tubos y conductos
- Todos los materiales
- No daña el tubo
- Zona de ataque reforzada
- Promedio indicativo de la carga de rotura: 40kg en extracción
- 100% Nylon / Poliamida 6 / Estabilizado UV / Ignífugo

TACO DE NYLON



 NYLON PLUG
 CHEVILLE NYLON
 NYLONDÜBEL

GRANEL 

CÓDIGO CODE CODE	MEDIDA SIZE MESURE		PRECIO TARIFA PRICE LIST PRIX TARIFS
	m.m.		€/100 u.
TNG04	4x20	100.000	1,73
TNG05	5x25	60.000	1,15
TNG06	6x30	38.000	1,41
TNG07	7x30	30.000	2,86
TNG08	8x40	17.000	2,72
TNG10	10x50	8.000	4,82
TNG12	12x60	5.000	8,41
TNG14	14x75	4.000	13,41
TNG14100	14x100	1.200	24,04



CAJA 

CÓDIGO CODE CODE	MEDIDA SIZE MESURE			PRECIO TARIFA PRICE LIST PRIX TARIFS
	m.m.			€/100 u.
TN04	4x20	100	4.000	2,03
TN05	5x25	100	12.000	1,50
TN06	6x30	100	8.000	1,54
TN07	7x30	100	4.000	3,27
TN08	8x40	100	4.000	3,07
TN10	10x50	50	2.000	5,16
TN12	12x60	25	1.000	9,38
TN14	14x75	20	800	15,29
TN14100	14x100	50	300	25,30

AUTOSERVICIO 

CÓDIGO CODE CODE	MEDIDA SIZE MESURE			PRECIO TARIFA PRICE LIST PRIX TARIFS
	m.m.			€/BOLSA
BFTN05	5x25	100	12	3,00
BFTN06	6x30	100	12	3,56
BFTN08	8x40	50	12	6,15
BFTN10	10x50	25	12	5,83

BLISTERS 

CÓDIGO CODE CODE	MEDIDA SIZE MESURE			PRECIO TARIFA PRICE LIST PRIX TARIFS
	m.m.			€/BLISTER
BTN04	4x20	25	15	1,60
BTN05	5x25	25	15	1,60
BTN06	6x30	25	15	1,60
BTN08	8x40	15	10	1,60
BTN10	10x50	10	10	1,60
BTN12	12x60	5	10	1,60

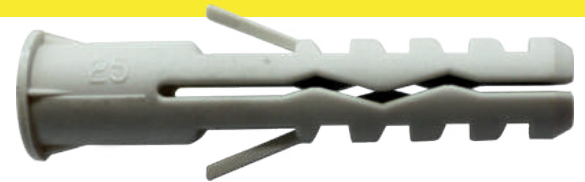
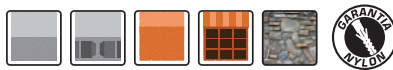

**PEDIDO MÍNIMO 1 EMBALAJE / MINIMUM ORDER 1 PACKAGING
 COMMANDE MINIMALE 1 EMBALLAGE / MINDESTBESTELLMENGE 1 VERPACKUNG**

TACO DE NYLON CON COLLARÍN





 NYLON PLUG WITH COLLARD
 CHEVILLE NYLON AVEC COLLERETE
 NYLONDÜBEL MIT SAUM

GRANEL 

CÓDIGO CODE CODE	MEDIDA SIZE MESURE		PRECIO TARIFA PRICE LIST PRIX TARIFS
	m.m.		€/100 u.
TNCG05	5x25	60.000	1,45
TNCG06	6x30	38.000	1,62
TNCG08	8x40	17.000	3,12
TNCG10	10x50	8.000	5,68

CAJA 



CÓDIGO CODE CODE	MEDIDA SIZE MESURE			PRECIO TARIFA PRICE LIST PRIX TARIFS
	m.m.			€/100 u.
TNC05	5x25	100	12.000	1,52
TNC06	6x30	100	8.000	1,70
TNC08	8x40	100	4.000	3,28
TNC10	10x50	50	2.000	5,98

TN / TNU
INFORMACIÓN TÉCNICA / TECHNICAL DATA

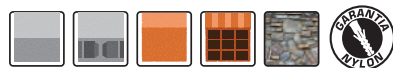

			
Ø4	2-3	Ø8	4,5-6
Ø5	3,5-4	Ø10	6-8
Ø6	4-5	Ø12	8-10
Ø7	4,5-5	Ø14	10-12

TACO DE NYLON GTX



 GTX NYLON PLUG
 CHEVILLE NYLON GTX
 NYLONDÜBEL GTX

CAJA

CÓDIGO CODE CODE	MEDIDA SIZE MESURE	BROCA DRILL FORET	PROF. MÍNIMA T. MIN. HOLE DEPTH PROF. MIN. TROU	Ø TORNILLO Ø SCREW Ø VIS			PRECIO TARIFA PRICE LIST PRIX TARIFS
							
	m.m.	m.m.	m.m.	m.m.			€/100 u.
GTX05	5x25	5	35	3-4	200	12.000	3,16
GTX06	6x30	6	40	4-5	100	6.000	3,25
GTX08	8x40	8	50	5-6	100	3.000	5,19
GTX10	10x50	10	70	6-8	50	1.500	9,35
GTX12	12x60	12	80	8-10	25	750	19,07
GTX14	14x70	14	90	10-12	20	600	24,07

AUTOSERVICIO

CÓDIGO CODE CODE	MEDIDA SIZE MESURE			PRECIO TARIFA PRICE LIST PRIX TARIFS
				
	m.m.			€/BOLSA
BFGTX05	5x25	100	12	4,27
BFGTX06	6x30	100	12	4,52
BFGTX08	8x40	50	12	8,76
BFGTX10	10x50	25	12	6,78



BLISTERS

CÓDIGO CODE CODE	MEDIDA SIZE MESURE			PRECIO TARIFA PRICE LIST PRIX TARIFS
				
	m.m.			€/BLISTER
BGTX05	5x25	25	15	2,09
BGTX06	6x30	25	15	2,09
BGTX08	8x40	15	10	2,09
BGTX10	10x50	10	10	2,09
BGTX12	12x60	6	10	2,09

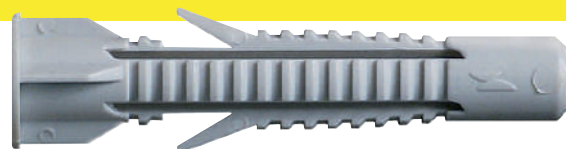

PEDIDO MÍNIMO 1 EMBALAJE / MINIMUM ORDER 1 PACKAGING
COMMANDE MINIMALE 1 EMBALLAGE / MINDESTBESTELLMENGE 1 VERPACKUNG

TACO DE NYLON UNIVERSAL

 UNIVERSAL NYLON PLUG
 CHEVILLE NYLON UNIVERSELLE
 NYLONDÜBEL UNIVERSAL

CAJA

CÓDIGO CODE CODE	MEDIDA SIZE MESURE	Ø TORNILLO Ø SCREW Ø VIS	PROF. MÍNIMA T. MIN. HOLE DEPTH PROF. MIN. TROU			PRECIO TARIFA PRICE LIST PRIX TARIFS
						
	m.m.	m.m.	m.m.			€/100 u.
TNU06	6x38	4-5	45	300	3.600	3,07
TNU08	8x42	5-6	60	100	1.200	5,19
TNU10	10x61	6-8	70	100	1.200	7,71

BLISTERS

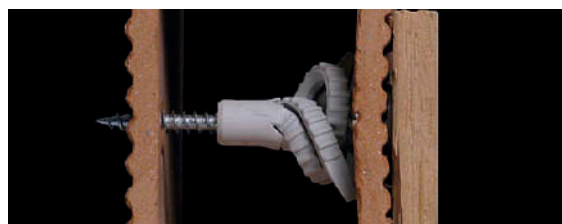

CÓDIGO CODE CODE	MEDIDA SIZE MESURE			PRECIO TARIFA PRICE LIST PRIX TARIFS
				
	m.m.			€/BLISTER
BTNU06	6x38	10	20	2,09
BTNU08	8x42	10	20	2,09
BTNU10	10x61	6	20	2,09



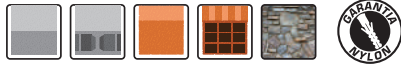

PEDIDO MÍNIMO 1 EMBALAJE / MINIMUM ORDER 1 PACKAGING
COMMANDE MINIMALE 1 EMBALLAGE / MINDESTBESTELLMENGE 1 VERPACKUNG

TACO DE NYLON VZ



 VZ NYLON PLUG
 CHEVILLE NYLON VZ
 NYLONDÜBEL VZ

CAJA

CÓDIGO CODE CODE	MEDIDA SIZE MESURE	BROCA DRILL FORET	PROF. MÍNIMA T. MIN. HOLE DEPTH PROF. MIN. TROU	TORNILLO SCREW VIS			PRECIO TARIFA PRICE LIST PRIX TARIFS
							
	m.m.	m.m.	m.m.	ØxL (m.m.)			€/100 u.
VZ06032	6x32	6	50	4,5x45	100	1.200	3,22
VZ06045	6x45	6	60	4,5x55	100	1.200	4,66
VZ08042	8x42	8	60	5x50	100	1.200	5,60
VZ08052	8x52	8	70	5x60	100	1.200	8,07
VZ10050	10x50	10	70	6x60	100	600	10,00
VZ12060	12x60	12	80	8x70	50	600	22,74
VZ14070	14x70	14	80	10x80	50	600	32,42
VZ14100	14x100	14	120	10x110	50	600	56,80

AUTOSERVICIO

CÓDIGO CODE CODE	MEDIDA SIZE MESURE			PRECIO TARIFA PRICE LIST PRIX TARIFS
				
	m.m.			€/BOLSA
BFVZ06032	6x32	100	12	5,72
BFVZ06045	6x45	100	12	6,69
BFVZ08042	8x42	100	12	7,62
BFVZ08052	8x52	100	12	11,11
BFVZ10050	10x50	50	12	7,18

BLISTERS

CÓDIGO CODE CODE	MEDIDA SIZE MESURE			PRECIO TARIFA PRICE LIST PRIX TARIFS
				
	m.m.			€/BLISTER
BVZ06032	6x32	25	12	2,09
BVZ06045	6x45	15	12	2,09
BVZ08042	8x42	15	12	2,09
BVZ08052	8x52	10	12	2,09
BVZ10050	10x50	10	12	2,09
BVZ12060	12x60	4	12	2,09

PEDIDO MÍNIMO 1 EMBALAJE / MINIMUM ORDER 1 PACKAGING
COMMANDE MINIMALE 1 EMBALLAGE / MINDESTBESTELLMENGE 1 VERPACKUNG

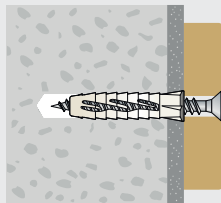
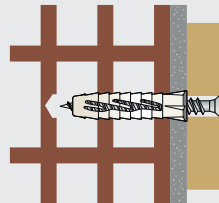
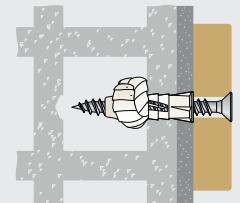
 Material macizo
 Solid materials

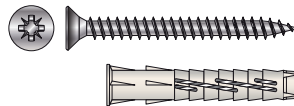
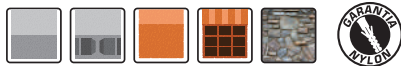
 Mampostería hueca
 Hollow masonry

 Material hueco
 Hollow materials

CLIPBOX VZ - TACO DE NYLON VZ CON TORNILLO

 VZ CLIPBOX - VZ NYLON PLUG WITH SCREW
 CLIPBOX VZ - CHEVILLE NYLON VZ AVEC VIS
 CLIPBOX VZ - NYLONDÜBEL VZ MIT SCHRAUBE

CAJA



CÓDIGO CODE CODE	MEDIDA SIZE MESURE	PRECIO TARIFA PRICE LIST PRIX TARIFS	PRECIO TARIFA PRICE LIST PRIX TARIFS
	m.m.		
CLIPBOX6	6x32 + 4,5x45	10,49	1.048,60
CLIPBOX8	8x42 + 5x50	10,49	1.048,60





TACO DE NYLON NUDO VS

 VS MULTI-PURPOSE NYLON PLUG
 CHEVILLE UNIVERSELLE RALLONGÉE EN NYLON VS
 UNIVERSAL-LANGSCHAFTDÜBEL AUS NYLON VS



CAJA

CÓDIGO CODE CODE	MEDIDA SIZE MESURE m.m.	BROCA DRILL FORET m.m.	TORNILLO SCREW VIS ∅xL (m.m.)	 		PRECIO TARIFA PRICE LIST PRIX TARIFS €/100 u.
				VS08080	8x80	
VS08100	8x100	8	6x105	50	300	24,15
VS08120	8x120	8	6x125	50	1.000	26,63
VS10080	10x80	10	7x85	50	1.200	25,38
VS10100	10x100	10	7x105	50	1.200	30,88
VS10120	10x120	10	7x125	50	1.200	36,38
VS10140	10x140	10	7x145	50	1.200	46,88

AUTOSERVICIO

CÓDIGO CODE CODE	MEDIDA SIZE MESURE m.m.	 		PRECIO TARIFA PRICE LIST PRIX TARIFS €/BOLSA
		BFVS08080	8x80	
BFVS08100	8x100	20	12	7,85
BFVS08120	8x120	15	12	6,75
BFVS10080	10x80	20	12	8,30
BFVS10100	10x100	15	12	7,71
BFVS10120	10x120	10	12	6,23

BLISTERS

CÓDIGO CODE CODE	MEDIDA SIZE MESURE m.m.	 		PRECIO TARIFA PRICE LIST PRIX TARIFS €/BLISTER
		BVS08080	8x80	
BVS08100	8x100	4	12	2,89
BVS08120	8x120	4	12	2,89
BVS10080	10x80	4	12	2,89
BVS10100	10x100	4	12	2,89
BVS10120	10x120	3	12	2,89

PEDIDO MÍNIMO 1 EMBALAJE / MINIMUM ORDER 1 PACKAGING
COMMANDE MINIMALE 1 EMBALLAGE / MINDESTBESTELLMENGE 1 VERPACKUNG

INFORMACIÓN TÉCNICA
**INSTALACIÓN EN HORMIGÓN
POR EXPANSIÓN RADIAL**

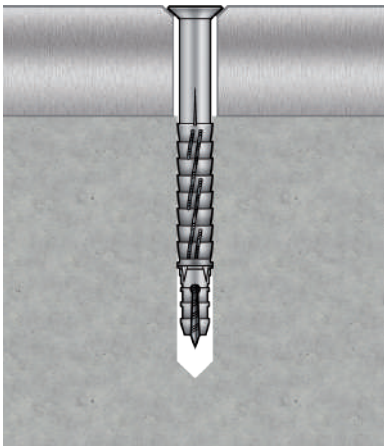
 INSTALLATION IN CONCRETE
 BY FULLY RADIAL EXPANSION

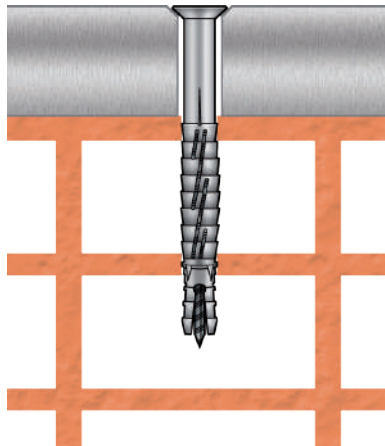
**INSTALACIÓN EN LADRILLO HUECO
POR EXPANSIÓN RADIAL MÚLTIPLE**

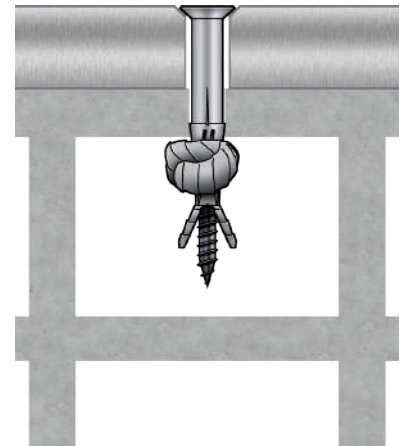
 INSTALLATION IN HOLLOW BRICK
 BY MULTIPLE RADIAL EXPANSION

**INSTALACIÓN EN HORMIGÓN
HUECO POR ANUDADO**

 INSTALLATION IN HOLLOW
 CONCRETE BY KNOTTING



TACO DE NYLON VS NUDO + TORNILLO CÓNICO TX

VS MULTI-PURPOSE NYLON ANCHOR WITH COUNTERSUNK TX SCREW
 CHEVILLE UNIVERSELLE RALLONGÉE EN NYLON VS AVEC VIS TX
 UNIVERSAL-LANGSCHAFTDÜBEL AUS NYLON VS MIT SENKKOPF-HOLZSCHRAUBE



CAJA

CÓDIGO CODE CODE	MEDIDA SIZE MESURE	BROCA DRILL FORET	TORNILLO SCREW VIS	LLAVE KEY CLÉ	CINCO		PRECIO TARIFA PRICE LIST PRIX TARIFS
							
	m.m.	m.m.	∅xL (m.m.)				€/100 u.
VSTC08080	8x80	8	6x85	T-30	100	1.000	48,33
VSTC08100	8x100	8	6x105	T-30	100	1.000	59,24
VSTC08120	8x120	8	6x125	T-30	100	1.000	69,17
VSTC08140	8x140	8	6x145	T-30	50	500	106,37
VSTC10080	10x80	10	7x85	T-40	50	500	61,94
VSTC10100	10x100	10	7x105	T-40	50	500	76,56
VSTC10120	10x120	10	7x125	T-40	50	500	91,26
VSTC10140	10x140	10	7x145	T-40	50	500	115,47
VSTC10160	10x160	10	7x165	T-40	50	500	139,07
VSTC10200	10x200	10	7x205	T-40	50	500	213,34
VSTC10230	10x230	10	7x235	T-40	25	250	283,34

AUTOSERVICIO

CÓDIGO CODE CODE	MEDIDA SIZE MESURE	CINCO		PRECIO TARIFA PRICE LIST PRIX TARIFS
				
	m.m.			€/BOLSA
BFVSTC08080	8x80	10	12	5,63
BFVSTC08100	8x100	8	12	7,04
BFVSTC08120	8x120	6	12	8,81
BFVSTC10080	10x80	6	12	8,32
BFVSTC10100	10x100	4	12	6,29

BLISTERS

CÓDIGO CODE CODE	MEDIDA SIZE MESURE	CINCO		PRECIO TARIFA PRICE LIST PRIX TARIFS
				
	m.m.			€/BLISTER
BVSTC08080	8x80	2	12	2,89
BVSTC08100	8x100	2	12	2,89
BVSTC08120	8x120	2	12	2,89
BVSTC10080	10x80	2	12	2,89
BVSTC10100	10x100	2	12	2,89
BVSTC10120	10x120	2	12	2,89

PEDIDO MÍNIMO 1 EMBALAJE / MINIMUM ORDER 1 PACKAGING
 COMMANDE MINIMALE 1 EMBALLAGE / MINDESTBESTELLMENGE 1 VERPACKUNG

TACO DE NYLON VS NUDO + TORNILLO CÓNICO TX INOXIDABLE A-4

VS MULTI-PURPOSE NYLON ANCHOR WITH COUNTERSUNK TX SCREW SS. AISI 316
 CHEVILLE UNIVERSELLE RALLONGÉE EN NYLON VS AVEC VIS TX INOX A-4
 UNIVERSAL-LANGSCHAFTDÜBEL AUS NYLON VS MIT SENKKOPF-HOLZSCHRAUBE
 EDELSTAHL A-4



CAJA

CÓDIGO CODE CODE	MEDIDA SIZE MESURE	BROCA DRILL FORET	TORNILLO SCREW VIS	LLAVE KEY CLÉ	INOX. A-4		PRECIO TARIFA PRICE LIST PRIX TARIFS
							
	m.m.	m.m.	∅xL (m.m.)				€/100 u.
VSTCA408080	8x80	8	6x85	T-30	100	1.000	162,75
VSTCA408100	8x100	8	6x105	T-30	100	1.000	194,04
VSTCA408120	8x120	8	6x125	T-30	100	1.000	226,38
VSTCA408140	8x140	8	6x145	T-30	50	500	369,73
VSTCA410080	10x80	10	7x85	T-40	50	500	209,88
VSTCA410100	10x100	10	7x105	T-40	50	500	246,54
VSTCA410120	10x120	10	7x125	T-40	50	500	282,88
VSTCA410140	10x140	10	7x145	T-40	50	500	362,50
VSTCA410160	10x160	10	7x165	T-40	50	500	458,35
VSTCA410200	10x200	10	7x205	T-40	50	500	722,57
VSTCA410230	10x230	10	7x235	T-40	25	250	839,90



TACO DE NYLON VS NUDO + TORNILLO CÓNICO TX INOXIDABLE A-4

VS MULTI-PURPOSE NYLON ANCHOR WITH COUNTERSUNK TX SCREW SS. AISI 316
 CHEVILLE UNIVERSELLE RALLONGÉE EN NYLON VS AVEC VIS TX INOX A-4
 UNIVERSAL-LANGSCHAFTDÜBEL AUS NYLON VS MIT SENKKOPF-HOLZSCHRAUBE
 EDELSTAHL A-4

AUTOSERVICIO

CÓDIGO CODE CODE	MEDIDA SIZE MESURE			PRECIO TARIFA PRICE LIST PRIX TARIFS
				
	m.m.			€/BOLSA
BFVSTC408080	8x80	8	12	20,34
BFVSTC408100	8x100	6	12	23,81
BFVSTC408120	8x120	5	12	21,53
BFVSTC410080	10x80	5	12	22,51
BFVSTC410100	10x100	4	12	26,31

BLISTERS

CÓDIGO CODE CODE	MEDIDA SIZE MESURE			PRECIO TARIFA PRICE LIST PRIX TARIFS
				
	m.m.			€/BLISTER
BVSTC408080	8x80	2	12	11,25
BVSTC408100	8x100	2	12	11,25
BVSTC408120	8x120	2	12	11,25
BVSTC410080	10x80	2	12	11,25
BVSTC410100	10x100	2	12	11,25
BVSTC410120	10x120	2	12	11,25

PEDIDO MÍNIMO 1 EMBALAJE / MINIMUM ORDER 1 PACKAGING
 COMMANDE MINIMALE 1 EMBALLAGE / MINDESTBESTELLMENGE 1 VERPACKUNG



TACO DE NYLON VS NUDO + TORNILLO HEXAGONAL TX

VS MULTI-PURPOSE NYLON ANCHOR WITH HEXAGONAL TX SCREW
 CHEVILLE UNIVERSELLE RALLONGÉE EN NYLON VS AVEC VIS TX
 UNIVERSAL-LANGSCHAFTDÜBEL AUS NYLON VS MIT SPECIAL-HOLZSCHRAUBE



CAJA

CÓDIGO CODE CODE	MEDIDA SIZE MESURE	BROCA DRILL FORET	TORNILLO SCREW VIS	LLAVE KEY CLÉ			PRECIO TARIFA PRICE LIST PRIX TARIFS
							
	m.m.	m.m.	øxL (m.m.)				€/100 U.
VST08080	8x80	8	6x85	T-30	100	1.000	53,229
VST08100	8x100	8	6x105	T-30	100	1.000	64,38
VST08120	8x120	8	6x125	T-30	100	1.000	79,79
VST08140	8x140	8	6x145	T-30	50	500	113,00
VST10080	10x80	10	7x85	T-40	50	500	72,47
VST10100	10x100	10	7x105	T-40	50	500	88,91
VST10120	10x120	10	7x125	T-40	50	500	98,25
VST10140	10x140	10	7x145	T-40	25	250	124,60
VST10160	10x160	10	7x165	T-40	25	250	149,04
VST10200	10x200	10	7x205	T-40	25	250	200,88
VST10230	10x230	10	7x235	T-40	25	250	332,94

AUTOSERVICIO

CÓDIGO CODE CODE	MEDIDA SIZE MESURE			PRECIO TARIFA PRICE LIST PRIX TARIFS
				
	m.m.			€/BOLSA
BFVST08080	8x80	10	12	6,75
BFVST08100	8x100	8	12	8,50
BFVST08120	8x120	6	12	8,94
BFVST10080	10x80	6	12	6,16
BFVST10100	10x100	4	12	7,13

BLISTERS









CÓDIGO CODE CODE	MEDIDA SIZE MESURE			PRECIO TARIFA PRICE LIST PRIX TARIFS
				
	m.m.			€/BLISTER
BVST08080	8x80	2	12	2,89
BVST08100	8x100	2	12	2,89
BVST08120	8x120	2	12	2,89
BVST10080	10x80	2	12	2,89
BVST10100	10x100	2	12	2,89
BVST10120	10x120	2	12	2,89

PEDIDO MÍNIMO 1 EMBALAJE / MINIMUM ORDER 1 PACKAGING
 COMMANDE MINIMALE 1 EMBALLAGE / MINDESTBESTELLMENGE 1 VERPACKUNG



TACO DE NYLON VS NUDO + TORNILLO HEXAGONAL TX INOXIDABLE A-4

VS MULTI-PURPOSE NYLON ANCHOR WITH HEXAGONAL TX SCREW - SS. AISI 316
 CHEVILLE UNIVERSELLE RALLONGÉE EN NYLON VS AVEC VIS TX INOX A-4
 UNIVERSAL-LANGSCHAFTDÜBEL VS MIT SPECIAL-HOLZSCHRAUBE
 EDELSTAHL A-4



CAJA

CÓDIGO CODE CODE	MEDIDA SIZE MESURE	BROCA DRILL FORET	TORNILLO SCREW VIS	LLAVE KEY CLÉ	INOX. A-4		PRECIO TARIFA PRICE LIST PRIX TARIFS
							
	m.m.	m.m.	∅xL (m.m.)				€/100 u.
VSTA408080	8x80	8	6x85	T-30	100	1.000	192,00
VSTA408100	8x100	8	6x105	T-30	100	1.000	237,38
VSTA408120	8x120	8	6x125	T-30	100	1.000	287,44
VSTA408140	8x140	8	6x145	T-30	50	500	438,27
VSTA410080	 10x80	10	7x85	T-40	50	500	273,41
VSTA410100	 10x100	10	7x105	T-40	50	500	308,38
VSTA410120	 10x120	10	7x125	T-40	50	500	348,16
VSTA410140	 10x140	10	7x145	T-40	25	250	409,38
VSTA410160	 10x160	10	7x165	T-40	25	250	487,32
VSTA410200	 10x200	10	7x205	T-40	25	250	835,13
VSTA410230	 10x230	10	7x235	T-40	25	250	961,85

AUTOSERVICIO

CÓDIGO CODE CODE	MEDIDA SIZE MESURE	INOX. A-4		PRECIO TARIFA PRICE LIST PRIX TARIFS
				
	m.m.			€/BOLSA
BFVST408080	8x80	8	12	23,62
BFVST408100	8x100	6	12	29,24
BFVST408120	8x120	5	12	22,24
BFVST410080	10x80	5	12	25,98
BFVST410100	10x100	4	12	29,19

BLISTERS

CÓDIGO CODE CODE	MEDIDA SIZE MESURE	INOX. A-4		PRECIO TARIFA PRICE LIST PRIX TARIFS
				
	m.m.			€/BLISTER
BVST408080	8x80	2	12	11,25
BVST408100	8x100	2	12	11,25
BVST408120	8x120	2	12	11,25
BVST410080	10x80	2	12	11,25
BVST410100	10x100	2	12	11,25
BVST410120	10x120	2	12	11,25

PEDIDO MÍNIMO 1 EMBALAJE / MINIMUM ORDER 1 PACKAGING
COMMANDE MINIMALE 1 EMBALLAGE / MINDESTBESTELLMENGE 1 VERPACKUNG

TACO DE NYLON VS NUDO + TORNILLO DOBLE ROSCA

VS MULTI-PURPOSE NYLON ANCHOR WITH SOCKET RECESS DUAL THREAD SCREW
 CHEVILLE UNIVERSELLE RALLONGÉE EN NYLON VS AVEC VIS DOUBLE FILETAGE À SIX PANS CREUX
 UNIVERSAL-LANGSCHAFTDÜBEL VS MIT INNENSECHSKANTSCHRAUBE MIT DOPPELTEN GEWINDE

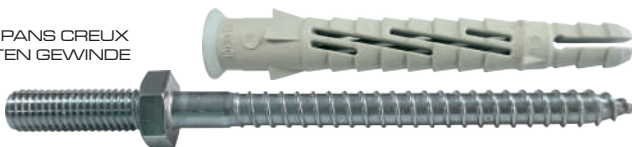
CAJA

CÓDIGO CODE CODE	MEDIDA SIZE MESURE	BROCA DRILL FORET	TORNILLO SCREW VIS	LLAVE KEY CLÉ	CINCADO		PRECIO TARIFA PRICE LIST PRIX TARIFS
							
	∅NxLn (m.m.)	m.m.	∅/MxLxLM (m.m.)	SW-H			€/100 u.
VSDR08080	8x80	8	∅6/M6x110x21	10-3	100	1.000	86,69
VSDR10080	10x80	10	∅7/M8x115x25	13-4	50	500	121,60

TACO DE NYLON VS NUDO + TORNILLO DOBLE ROSCA INOXIDABLE A-4

VS MULTI-PURPOSE NYLON ANCHOR WITH SOCKET RECESS DUAL THREAD SCREW SS. AISI 316
 CHEV. UNIVERSELLE RALLONGÉE EN NYLON VS AVEC VIS DOUBLE FILETAGE À SIX PANS CREUX INOX A-4
 UNIVERSAL-LANGSCHAFTDÜBEL VS MIT INNENSECHSKANTSCHRAUBE MIT DOPPELTEN GEWINDE
 EDELSTAHL A-4

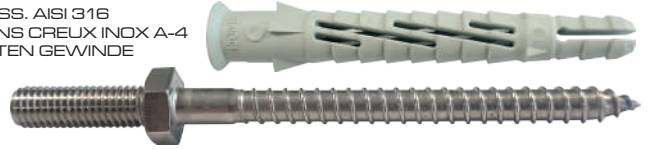

CAJA

CÓDIGO CODE CODE	MEDIDA SIZE MESURE	BROCA DRILL FORET	TORNILLO SCREW VIS	LLAVE KEY CLÉ	CINCO		PRECIO TARIFA PRICE LIST PRIX TARIFS
	∅NxLn (m.m.)	m.m.	∅/MxLxLM (m.m.)	SW-H			€/100 u.
VSDRA408080	8x80	8	∅6/M6x110x21	10 / 3	100	1.000	355,22
VSDRA410080	10x80	10	∅7/M8x115x25	13 / 4	50	500	537,44

TACO DE NYLON VS NUDO + TORNILLO INVOLABLE TX

VS MULTI-PURPOSE NYLON ANCHOR WITH SECURITY TX SCREW
 CHEVILLE UNIVERSELLE RALLONGÉE EN NYLON VS AVEC VIS INVOLABLE TX
 UNIVERSAL-LANGSCHAFTDÜBEL AUS NYLON VS MIT SICHERHEITSSCHRAUBE



CAJA

CÓDIGO CODE CODE	MEDIDA SIZE MESURE	BROCA DRILL FORET	TORNILLO SCREW VIS	LLAVE KEY CLÉ	CINCO		PRECIO TARIFA PRICE LIST PRIX TARIFS
	m.m.	m.m.	∅xL (m.m.)				€/100 u.
VSTI08080	8x80	8	6x85	T-30	100	1.000	70,44
VSTI08100	8x100	8	6x105	T-30	100	1.000	85,25
VSTI08120	8x120	8	6x125	T-30	100	1.000	105,13
VSTI08140	8x140	8	6x145	T-30	50	500	133,29
VSTI10080	10x80	10	7x85	T-40	50	500	94,60
VSTI10100	10x100	10	7x105	T-40	50	500	116,85
VSTI10120	10x120	10	7x125	T-40	50	500	130,94
VSTI10140	10x140	10	7x145	T-40	25	250	183,44
VSTI10160	10x160	10	7x165	T-40	25	250	205,85
VSTI10200	10x200	10	7x205	T-40	25	250	324,07

AUTOSERVICIO

CÓDIGO CODE CODE	MEDIDA SIZE MESURE	CINCO		PRECIO TARIFA PRICE LIST PRIX TARIFS
	m.m.			€/BOLSA
BFVSTI08080	8x80	10	12	9,64
BFVSTI08100	8x100	8	12	10,44
BFVSTI10080	10x80	6	12	10,09
BFVSTI10100	10x100	4	12	12,93

**PEDIDO MÍNIMO 1 EMBALAJE
 MINIMUM ORDER 1 PACKAGING**

TACO DE NYLON PARA MARCOS

NYLON FRAME ANCHOR ASSEMBLED
 CHEVILLE CADRE EN NYLON RALLONGÉE ASSEMBLÉE
 LANGSCHAFTDÜBEL AUS NYLON FÜR FENSTERRAHMEN

CAJA

CÓDIGO CODE CODE	MEDIDA SIZE MESURE m.m.	BROCA DRILL FORET m.m.	TORNILLO SCREW VIS ØxL (m.m.)	LLAVE KEY CLÉ PZ	PROF. TALADRO HOLE DEPTH PROF. TROU m.m.	PRECIO TARIFA PRICE LIST PRIX TARIFS	
						50	600
TNM08075	8x75	8	5x85	3	75	50	600
TNM08100	8x100	8	5x110	3	100	50	600
TNM08120	8x120	8	5x130	3	120	50	600
TNM08140	8x140	8	5x150	3	140	50	400
TNM10075	10x75	10	6x85	3	75	50	400
TNM10100	10x100	10	6x110	3	100	50	400
TNM10120	10x120	10	6x130	3	120	50	400
TNM10140	10x140	10	6x175	3	140	50	400

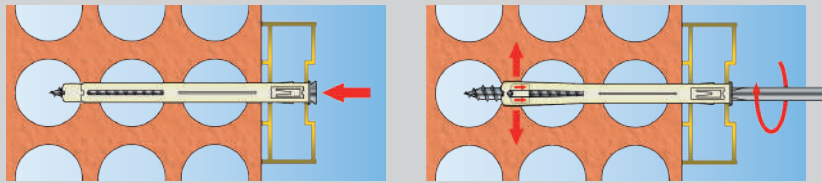
INSTALACIÓN

TACO DE NYLON TRIPLE EXPANSIÓN

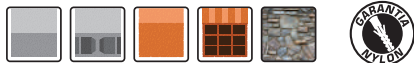
EXTENDED NYLON ANCHOR WITH SIX WINGS
 CHEVILLE NYLON AVEC SIX AILETTES
 NYLON-LANGSCHAFTDÜBELMIT SECHS FLÜGEL

CAJA

CÓDIGO CODE CODE	MEDIDA SIZE MESURE m.m.	BROCA DRILL FORET m.m.	TORNILLO SCREW VIS Ø (m.m.)	PRECIO TARIFA PRICE LIST PRIX TARIFS	
				100	1.200
TNT08080	8x80	8	5,5	100	1.200
TNT08100	8x100	8	5,5	50	600
TNT08120	8x120	8	5,5	50	600
TNT10080	10x80	10	7	50	600
TNT10100	10x100	10	7	50	600
TNT10135	10x140	10	7	50	300
TNT10160	10x160	10	7	50	300

BLISTERS



CÓDIGO CODE CODE	MEDIDA SIZE MESURE m.m.	PRECIO TARIFA PRICE LIST PRIX TARIFS	
		4	15
BTNT08080	8x80	4	15
BTNT08100	8x100	4	15
BTNT08120	8x120	4	15
BTNT10080	10x80	4	15
BTNT10100	10x100	2	15

**PEDIDO MÍNIMO 1 EMBALAJE
 MINIMUM ORDER 1 PACKAGING**



TACO DE NYLON TRIPLE EXPANSIÓN + TORNILLO DIN 571 CINCADO

EXT. NYLON ANCHOR WITH SIX WINGS AND HEX. WOOD SCREW DIN 571
 CHEVILLE NYLON AVEC SIX AILETTES ET VIS À BOIS TÊTE HEX. DIN 571
 NYLON-LANGSCHAFTDÜBEL MIT SECHS FLÜGEL UND DIN 571

CAJA

CÓDIGO CODE CODE	MEDIDA SIZE MESURE m.m.	BROCA DRILL FORET m.m.	TORNILLO SCREW VIS Ø (m.m.)	LLAVE KEY CLÉ SW	CINCO		PRECIO TARIFA PRICE LIST PRIX TARIFS €/100 U.
							
					100	1.200	
TNTT08080	8x80	8	5,5	10	100	1.200	35,41
TNTT08100	8x100	8	5,5	10	50	600	43,32
TNTT08120	8x120	8	5,5	10	50	300	49,59
TNTT10080	10x80	10	7	12	50	300	47,07
TNTT10100	10x100	10	7	12	50	300	55,97
TNTT10140	10x140	10	7	12	50	300	73,21
TNTT10160	10x160	10	7	12	50	300	92,09

BLISTERS



CÓDIGO CODE CODE	MEDIDA SIZE MESURE m.m.			PRECIO TARIFA PRICE LIST PRIX TARIFS €/BLISTER	CINCO
					15
					2,89
BTNTT08080	8x80	2	15	2,89	
BTNTT08100	8x100	2	15	2,89	
BTNTT10080	10x80	2	15	2,89	
BTNTT10100	10x100	2	15	2,89	

**PEDIDO MÍNIMO 1 EMBALAJE
 MINIMUM ORDER 1 PACKAGING**



TACO DE NYLON TRIPLE EXPANSIÓN + TORNILLO CÓNICO PZ

EXT. NYLON ANCHOR WITH SIX WINGS AND COUNTERSUNK WOOD SCREW
 CHEVILLE NYLON AVEC SIX AILETTES ET VIS CONIQUE
 NYLON-LANGSCHAFTDÜBEL MIT SECHS FLÜGEL UND HOLZSCHRAUBE

CAJA

CÓDIGO CODE CODE	MEDIDA SIZE MESURE m.m.	BROCA DRILL FORET m.m.	TORNILLO SCREW VIS Ø (m.m.)	LLAVE KEY CLÉ PZ	CINCO		PRECIO TARIFA PRICE LIST PRIX TARIFS €/100 U.
							
					50	1.200	
TNTTC08080	8x80	8	5,5	3	50	1.200	33,33
TNTTC08100	8x100	8	5,5	3	25	600	40,00
TNTTC08120	8x120	8	5,5	3	25	600	46,67
TNTTC10080	10x80	10	7	4	25	600	43,30
TNTTC10100	10x100	10	7	4	25	600	52,67
TNTTC10140	10x140	10	7	4	25	300	68,90
TNTTC10160	10x160	10	7	4	25	300	86,67

BLISTERS



CÓDIGO CODE CODE	MEDIDA SIZE MESURE m.m.			PRECIO TARIFA PRICE LIST PRIX TARIFS €/BLISTER	CINCO
					15
					2,89
BTNTTC08080	8x80	2	15	2,89	
BTNTTC08100	8x100	2	15	2,89	
BTNTTC08120	8x120	2	15	2,89	
BTNTTC10080	10x80	2	15	2,89	
BTNTTC10100	10x100	2	15	2,89	

**PEDIDO MÍNIMO 1 EMBALAJE
 MINIMUM ORDER 1 PACKAGING**



TACO CLAVO CABEZA CÓNICA

NYLON FAST ANCHOR WITH COUNTERSUNK COLLAR
 CHEVILLE PRÉMONTE À FRAPPER
 NYLONDÜBEL MIT SENKSAUM, MIT VERZINKTER
 SENKKOPF-NAGELSCHRAUBE



CAJA

CÓDIGO CODE CODE	MEDIDA SIZE MESURE	CINCADO		PRECIO TARIFA PRICE LIST PRIX TARIFS
				
	m.m.			€/100 u.
TCC05030	5x30	100	1.200	5,34
TCC05045	5x45	100	1.200	6,85
TCC06035	6x35	100	1.200	6,61
TCC06040	6x40	100	1.200	6,73
TCC06060	6x60	100	1.200	9,50
TCC06070	6x70	100	1.200	11,73
TCC06080	6x80	200	2.000	12,77



CAJA

CÓDIGO CODE CODE	MEDIDA SIZE MESURE	CINCADO		PRECIO TARIFA PRICE LIST PRIX TARIFS
				
	m.m.			€/100 u.
TCC06100	6x100	100	1.000	17,61
TCC08060	8x60	100	600	15,41
TCC08080	8x80	100	600	18,20
TCC08100	8x100	100	600	21,85
TCC08120	8x120	50	600	27,15
TCC08135	8x135	50	600	32,10
TCC08160	8x160	100	1.000	46,22

AUTOSERVICIO

CÓDIGO CODE CODE	MEDIDA SIZE MESURE	CINCADO		PRECIO TARIFA PRICE LIST PRIX TARIFS
				
	m.m.			€/BOLSA
BFTCC05030	5x30	30	12	2,48
BFTCC05045	5x45	30	12	3,32
BFTCC06035	6x35	30	12	3,19
BFTCC06040	6x40	30	12	3,26
BFTCC06060	6x60	25	12	3,82
BFTCC08060	8x60	20	12	4,19
BFTCC08080	8x80	20	12	5,32
BFTCC08100	8x100	10	12	4,13

BLISTERS



CÓDIGO CODE CODE	MEDIDA SIZE MESURE	CINCADO		PRECIO TARIFA PRICE LIST PRIX TARIFS
				
	m.m.			€/BLISTER
BTCC05030	5x30	4	20	2,09
BTCC05045	5x45	4	20	2,09
BTCC06035	6x35	4	20	2,09
BTCC06040	6x40	4	20	2,09
BTCC06060	6x60	4	20	2,09
BTCC06070	6x70	4	20	2,09
BTCC08060	8x60	4	20	2,09
BTCC08080	8x80	4	20	2,09
BTCC08100	8x100	2	20	2,09

PEDIDO MÍNIMO 1 EMBALAJE / MINIMUM ORDER 1 PACKAGING
 COMMANDE MINIMALE 1 EMBALLAGE / MINDESTBESTELLMENGE 1 VERPACKUNG



TACO CLAVO CABEZA CÓNICA INOXIDABLE A-2

NYLON FAST ANCHOR WITH COUNTERSUNK COLLAR - SS. AISI 304
 CHEVILLE PRÉMONTE À FRAPPER - INOX. A-2
 NYLONDÜBEL MIT SENKSAUM, MIT SENKKOPF-NAGELSCHRAUBE
 EDELSTAHL A-2



CAJA

CÓDIGO CODE CODE	MEDIDA SIZE MESURE	LLAVE KEY CLÉ	INOX. A-2		PRECIO TARIFA PRICE LIST PRIX TARIFS
					
	m.m.	PZ			€/100 u.
TCCI05030	5x30	2	200	2.400	23,41
TCCI06040	6x40	2	100	1.200	35,69
TCCI06060	6x60	2	100	1.200	44,35
TCCI08060	8x60	3	100	600	69,88
TCCI08080	8x80	3	100	600	82,00
TCCI08100	8x100	3	100	600	101,57

AUTOSERVICIO

CÓDIGO CODE CODE	MEDIDA SIZE MESURE	INOX. A-2		PRECIO TARIFA PRICE LIST PRIX TARIFS
				
	m.m.			€/BOLSA
BFTCCI05030	5x30	30	12	11,32
BFTCCI06040	6x40	30	12	14,23
BFTCCI06060	6x60	25	12	13,79
BFTCCI08060	8x60	20	12	18,47
BFTCCI08080	8x80	10	12	22,82
BFTCCI08100	8x100	10	12	18,14

BLISTERS



CÓDIGO CODE CODE	MEDIDA SIZE MESURE	INOX. A-2		PRECIO TARIFA PRICE LIST PRIX TARIFS
				
	m.m.			€/BLISTER
BTCCI05030	5x30	4	20	3,89
BTCCI06040	6x40	4	20	3,89
BTCCI06060	6x60	4	20	3,89
BTCCI08060	8x60	2	20	3,89
BTCCI08080	8x80	2	20	3,89
BTCCI08100	8x100	2	20	3,89

PEDIDO MÍNIMO 1 EMBALAJE / MINIMUM ORDER 1 PACKAGING
 COMMANDE MINIMALE 1 EMBALLAGE / MINDESTBESTELLMENGE 1 VERPACKUNG



TACO CLAVO CABEZA PLANA

NYLON FAST ANCHOR WITH FLAT COLLAR
 CHEVILLE PRÉMONTE CYLINDRIQUE À FRAPPER
 NYLONDÜBEL MIT ZYLINDERSAUM, MIT VERZINKTER
 SENKKOPF-NAGELSCHRAUBE



CAJA

CÓDIGO CODE CODE	MEDIDA SIZE MEASURE	CINCADO		PRECIO TARIFA PRICE LIST PRIX TARIFS
				
	m.m.			€/100 u.
TC05025	5x25	100	1.200	5,17
TC05030	5x30	100	1.200	5,34
TC05045	5x45	100	1.200	6,10
TC06035	6x35	100	1.200	6,60
TC06040	6x40	100	1.200	7,08
TC06060	6x60	100	1.200	9,84
TC06070	6x70	100	1.200	11,38
TC06080	6x80	200	2.000	13,47



CAJA

CÓDIGO CODE CODE	MEDIDA SIZE MEASURE	CINCADO		PRECIO TARIFA PRICE LIST PRIX TARIFS
				
	m.m.			€/100 u.
TC06100	6x100	100	1.000	17,61
TC08060	8x60	100	600	15,42
TC08080	8x80	100	600	18,87
TC08100	8x100	100	600	22,27
TC08120	8x120	50	600	27,15
TC08135	8x135	50	600	30,54
TC08160	8x160	100	1.000	46,22

AUTOSERVICIO

CÓDIGO CODE CODE	MEDIDA SIZE MEASURE	CINCADO		PRECIO TARIFA PRICE LIST PRIX TARIFS
				
	m.m.			€/BOLSA
BFTC05030	5x30	30	12	2,48
BFTC05045	5x45	30	12	3,32
BFTC06035	6x35	30	12	3,19
BFTC06040	6x40	30	12	3,26
BFTC06060	6x60	25	12	3,82
BFTC06080	6x80	25	12	4,35
BFTC08060	8x60	20	12	4,19
BFTC08080	8x80	20	12	5,32
BFTC08100	8x100	10	12	4,13

BLISTERS



CÓDIGO CODE CODE	MEDIDA SIZE MEASURE	CINCADO		PRECIO TARIFA PRICE LIST PRIX TARIFS
				
	m.m.			€/BLISTER
BTC05030	5x30	4	20	2,09
BTC05045	5x45	4	20	2,09
BTC06035	6x35	4	20	2,09
BTC06040	6x40	4	20	2,09
BTC06060	6x60	4	20	2,09
BTC06070	6x70	4	20	2,09
BTC08060	8x60	4	20	2,09
BTC08080	8x80	4	20	2,09
BTC08100	8x100	2	20	2,09

PEDIDO MÍNIMO 1 EMBALAJE / MINIMUM ORDER 1 PACKAGING
COMMANDE MINIMALE 1 EMBALLAGE / MINDESTBESTELLMENGE 1 VERPACKUNG

TACO CLAVO ABRAZADERA

NYLON FAST ANCHOR WITH DOUBLE THREAD
 CHEVILLE PRÉMONTE AVEC VIS POUR COLLIER ET CRAMPON
 NYLONDÜBEL MIT ZYLINDERSAUM, MIT VERZINKTER DOPPELGEWINDESCHRAUBE



CAJA

CÓDIGO CODE CODE	MEDIDA SIZE MEASURE	Ø EXTERIOR Ø OUTSIDE Ø EXTÉRIEUR	CINCADO		PRECIO TARIFA PRICE LIST PRIX TARIFS
					
	m.m.	m.m.			€/100 u.
TCA06035	6x35	6	100	1.200	20,02
TCA08060	8x60	8	50	1.200	29,23

TACO DE NYLON FN

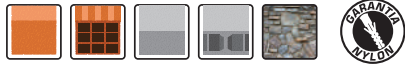
NYLON ANCHOR WITH STEEL CONICAL EXPANSION NUT
 CHEVILLE NYLON AVEC ÉCROU EN LAITON À EXPANSION ET VIS TÊTE HEX.
 NYLONDÜBEL MIT SPREIZ-SCHRAUBEN MUTTER AUS MESSING



CAJA

CÓDIGO CODE CODE	MEDIDA SIZE MESURE m.m.	BROCA DRILL FORET m.m.			PRECIO TARIFA PRICE LIST PRIX TARIFS €/100 u.
					
FN08	8x80	12	100	600	36,85
FN10	10x80	14	100	600	50,50



TACO DE NYLON FN + TORNILLO DIN 933 CINCADO

NYLON ANCHOR WITH STEEL CONICAL EXPANSION NUT AND HEX. SCREW DIN 933
 CHEVILLE NYLON AVEC ÉCROU EN LAITON À EXPANSION ET VIS TÊTE HEX. DIN 933
 NYLONDÜBEL MIT SPREIZ-SCHRAUBEN MUTTER AUS MESSING UND DIN 933

CAJA

CÓDIGO CODE CODE	MEDIDA SIZE MESURE m.m.	BROCA DRILL FORET m.m.	LLAVE KEY CLÉ SW	PROF. TALADRO HOLE DEPTH PROF. TROU m.m.			PRECIO TARIFA PRICE LIST PRIX TARIFS €/100 u.
							
FNT08	8x80	12	13	80	100	600	65,63
FNT10	10x80	14	17	80	100	600	93,75

BLISTERS

CÓDIGO CODE CODE	MEDIDA SIZE MESURE m.m.			PRECIO TARIFA PRICE LIST PRIX TARIFS €/BLISTER
				
BFNT08	8x80	2	12	-
BFNT10	10x80	2	12	-

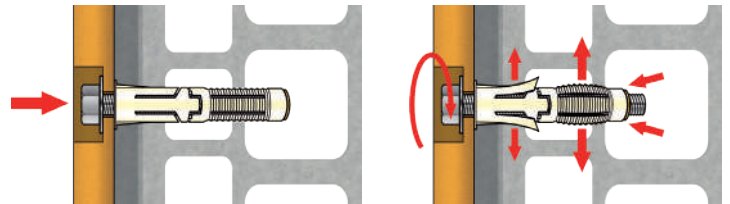

PEDIDO MÍNIMO 1 EMBALAJE / MINIMUM ORDER 1 PACKAGING
COMMANDE MINIMALE 1 EMBALLAGE / MINDESTBESTELLMENGE 1 VERPACKUNG

TACO RASTREL

EXPRESS NAIL FOR LIGHT FASTENINGS
 CHEVILLE ÉLASTIQUE POUR FIXATION DE LITEAUX
 ELASTIC SPRUNGGELENK FÜR SCHELLEN UND LEICHT FIXIEREN

CAJA

CÓDIGO CODE CODE	MEDIDA SIZE MESURE m.m.	BROCA DRILL FORET m.m.	PROF. TALADRO HOLE DEPTH PROF. TROU m.m.			PRECIO TARIFA PRICE LIST PRIX TARIFS €/100 u.
						
RASTRELO6030	6x30	6	30	200	1.600	13,75
RASTRELO6040	6x40	6	40	200	1.600	15,32
RASTRELO6050	6x50	6	50	200	1.600	15,47
RASTRELO6060	6x60	6	60	200	1.600	17,66
RASTRELO6080	6x80	6	80	200	1.600	22,29
RASTRELO8070	8x70	8	70	100	1.600	26,85
RASTRELO8090	8x90	8	90	100	1.600	33,41
RASTRELO8110	8x110	8	110	100	800	40,00
RASTRELO8130	8x130	8	130	100	800	45,10
RASTRELO8150	8x150	8	150	100	800	52,91

TACO AUTOPERFORANTE PARA CARTÓN-YESO / NYLON Y ZAMAK



 SELF DRILLING ANCHOR FOR PLASTERBOARD
 CHEVILLE AUTOPERCEUSE POUR PLAQUES DE PLÂTRE
 SELBSTBOHRENDEN-DÜBEL FÜR GIPSKARTON

ZAMAK





NYLON



CAJA

CÓDIGO CODE CODE	MATERIAL MATERIAL MATÉRIEL	LARGO LENGTH LONGUEUR	TORNILLO SCREW VIS	ESPESSOR PARED WALL THICKNESS ÉPAISSEUR DU MUR			PRECIO TARIFA PRICE LIST PRIX TARIFS
		m.m.	∅xL (m.m.)	m.m.			€/100 u.
TPN	NYLON	37	4,5x35	5 - 17	200	2.400	11,44
TPZ	ZAMAK	37	4,5x35	5 - 17	200	2.400	24,35

AUTOSERVICIO



CÓDIGO CODE CODE	MATERIAL MATERIAL MATÉRIEL			PRECIO TARIFA PRICE LIST PRIX TARIFS
				€/BOLSA
BFTPN	NYLON	25	12	4,97
BFTPZ	ZAMAK	25	12	9,57

BLISTERS

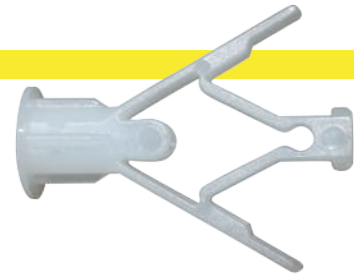
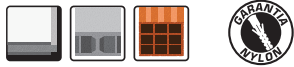

CÓDIGO CODE CODE	MATERIAL MATERIAL MATÉRIEL			PRECIO TARIFA PRICE LIST PRIX TARIFS
				€/BLISTER
BTPN	NYLON	4	15	2,09
BTPZ	ZAMAK	4	15	2,09

PEDIDO MÍNIMO 1 EMBALAJE / MINIMUM ORDER 1 PACKAGING
COMMANDE MINIMALE 1 EMBALLAGE / MINDESTBESTELLMENGE 1 VERPACKUNG
TACO DE NYLON CON ALAS PARA CARTÓN-YESO



 WINGS ANCHOR FOR PLASTERBOARD
 CHEVILLE AVEC AILETTES POUR PLAQUES DE PLÂTRE
 DÜBEL FÜR GIPSKARTON MIT ZWEI FLÜGEL

CAJA

CÓDIGO CODE CODE	MEDIDA SIZE MESURE	BROCA DRILL FORET	TORNILLO (MÍNIMO) SCREW (MINIMUM) VIS (MINIMUM)	ESPESSOR PARED WALL THICKNESS ÉPAISSEUR DU MUR			PRECIO TARIFA PRICE LIST PRIX TARIFS
	m.m.	m.m.	∅xL (m.m.)	m.m.			€/100 u.
TPA0838	8x38	8	3,5x40	6 - 13	100	1.200	9,67
TPA0847	8x47	8	3,5x50	13 - 20	100	1.200	11,67
TPA1038	10x38	10	4x50	6 - 13	100	1.200	10,33
TPA1047	10x47	10	4x60	13 - 20	100	600	12,33

AUTOSERVICIO

CÓDIGO CODE CODE	MEDIDA SIZE MESURE			PRECIO TARIFA PRICE LIST PRIX TARIFS
	m.m.			€/BOLSA
BFTPA0838	8x38	15	12	2,75
BFTPA0847	8x47	15	12	3,04
BFTPA1038	10x38	10	12	2,32
BFTPA1047	10x47	10	12	2,50

BLISTERS

CÓDIGO CODE CODE	MEDIDA SIZE MESURE			PRECIO TARIFA PRICE LIST PRIX TARIFS
	m.m.			€/BLISTER
BTPA1038	10x38	4	12	2,09
BTPA1047	10x47	4	12	2,09

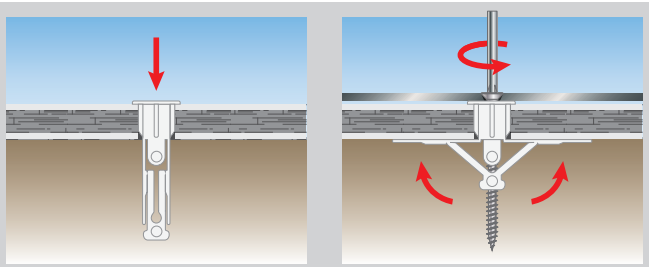
PEDIDO MÍNIMO 1 EMBALAJE / MINIMUM ORDER 1 PACKAGING
COMMANDE MINIMALE 1 EMBALLAGE / MINDESTBESTELLMENGE 1 VERPACKUNG
INSTALACIÓN

TACO DE PLÁSTICO BLANCO

 WHITE WINGS PLASTIC PLUG
 CHEVILLE PLASTIQUE BLANC
 KUNSTSTOFF-DÜBEL WEISS

BOLSA

CÓDIGO CODE CODE	MEDIDA SIZE MESURE m.m.	BROCA DRILL FORET m.m.	TORNILLO SCREW VIS Ø (m.m.)			PRECIO TARIFA PRICE LIST PRIX TARIFS €/100 u.
						
TP05	5x20	5	1 - 2,5	25	1.000	1,61
TP06	6x22	6	2 - 3,5	25	1.000	1,93
TP07	7x21	7	3 - 4	25	1.000	2,50
TP08	8x25	8	3 - 4,5	25	1.000	2,88
TP09	9x30	9	4 - 5,5	25	1.000	3,50
TP10	10x34	10	4 - 6	25	1.000	4,50
TP10L	10x40	10	4 - 6	25	1.000	5,44
TP12	12x42	12	4 - 6	25	1.000	10,04

BASCULANTES

 GRAVITY TOGGLES
 CHEVILLE BASCULENTE
 KIPPDÜBEL



CAJA

CÓDIGO CODE / CODE	CÓDIGO CODE / CODE	MÉTRICA METRICS MÉTRIQUE m.m.		PRECIO TARIFA / PRICE LIST €/100 u.	
				RECTO STRAIGHT / DROIT	GANCHO HOOK / CROCHET
BRSD4	BRGD4	M 4	50	59,59	64,17
BRSD5	BRGD5	M 5	50	70,94	83,50
BRSD6	BRGD6	M 6	50	92,90	99,60

FIJACIONES PARA WC

WC FIXATIONS / FIXATIONS POUR WC / BEFESTIGUNGEN FÜR WC

BOLSA

CÓDIGO CODE CODE	MEDIDA SIZE MESURE m.m.	MATERIAL MATERIAL MATÉRIEL			PRECIO TARIFA PRICE LIST PRIX TARIFS €/100 u.
					
WCZ06070	6x70	ACERO CINCADO	2	100	102,92
WCA206070	6x70	ACERO INOX. A-2	2	100	226,33
WCLA06070	6x70	LATÓN	2	100	275,01
FL08110	8x110	ACERO CINCADO	2	100	139,12
FL10120	10x120	ACERO CINCADO	2	100	245,79
FLA208110	8x110	ACERO INOX. A-2	2	100	609,38
FLN10120	10x120	NYLON	2	100	249,38
WCH06070	6x70	ACERO CINCADO	2	100	229,25

ESPIGA PARA PANEL AISLANTE EPA

EPA ANCHOR FOR INSULATING PANELS FIXING IN CONCRETE
CHEVILLE POUR PANNEAUX D'ISOLATION SUR BÉTON EPA
DÜBEL FÜR BEFESTIGUNG VON ISOLIERPLATTE AUF BETON EPA

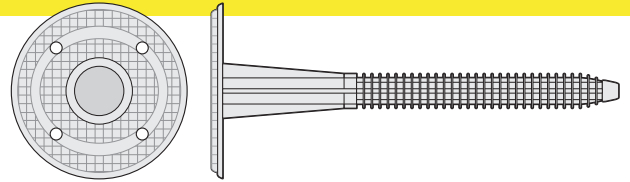

CAJA

CÓDIGO CODE CODE	MEDIDA SIZE MEASURE (\varnothing xL) m.m.	BROCA DRILL FORET (\varnothing) m.m.	ESPESOR A FIJAR THICKNESS TO FIX ÉPAISSEUR m.m.		PRECIO TARIFA PRICE LIST PRIX TARIFS €/100 u.
EPAB050	8x50	8	10/20	500	24,72
EPAB070	8x70	8	20/40	400	25,97
EPAB090	8x90	8	40/60	300	27,41
EPAB110	8x110	8	60/80	300	32,32

ESPIGA PARA PANEL AISLANTE EPAM

EPAM ANCHOR WITH NAIL FOR INSULATING PANELS FIXING IN CONCRETE
CHEVILLE AVEC CLOU POUR PANNEAUX D'ISOLATION SUR BÉTON EPAM
DÜBEL MIT NAGEL FÜR BEFESTIGUNG VON ISOLIERPLATTE AUF BETON EPAM



CAJA

CÓDIGO CODE CODE	MEDIDA SIZE MEASURE (\varnothing xL) m.m.	BROCA DRILL FORET (\varnothing) m.m.	ESPESOR MÁX. A FIJAR MAX. THICKNESS TO FIX ÉPAISSEUR MAX. (TFIX) m.m.	D m.m.	L1 m.m.	PROF. TALADRO HOLE DEPTH PROF. TROU m.m.		PRECIO TARIFA PRICE LIST PRIX TARIFS €/100 u.
EPAM10070	10x70	10	30	53	30	40	200	21,41
EPAM10090	10x90	10	50	53	30	40	200	23,30
EPAM10110	10x110	10	70	53	30	40	200	23,90
EPAM10130	10x130	10	90	53	30	40	200	26,14
EPAM10150	10x150	10	110	58	30	40	200	27,14
EPAM10180	10x180	10	140	58	30	40	200	32,14

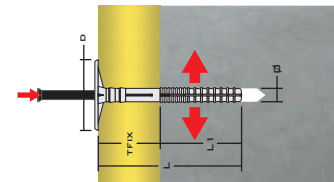
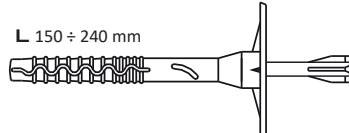
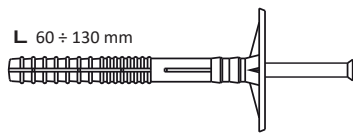

ARANDELA DE ACERO PARA PANEL AISLANTE

STEEL LARGE WASHER FOR INSULATED PANELS FIXING
RONDELLE EN ACIER POUR PANNEAUX D'ISOLATION
SCHEIBE FÜR BEFESTIGUNG VON ISOLIERPLATTE

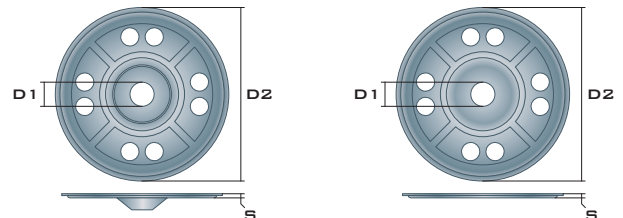

CAJA

CÓDIGO CODE / CODE	CÓDIGO CODE / CODE	\varnothing INTERIOR \varnothing INSIDE \varnothing INTÉRIEUR (D1) m.m.	\varnothing EXTERIOR \varnothing OUTSIDE \varnothing EXTÉRIEUR (D2) m.m.	GROSOR THICKNESS ÉPAISSEUR (S) m.m.		PRECIO TARIFA PRICE LIST PRIX TARIFS €/100 u.
AVELLANADA COUNTERSUNK / FRAISE	PLANA FLAT / PLAT					
LU 0106	LY 0106	6,5	70	0,7	100	23,40
LU 0109	LY 0109	9	70	0,7	100	23,40

TORNILLO DIN 7505-A BICROMATADO PZ

CHIPBOARD SCREW PZ YELLOW ZINC PLATED
VIS À BOIS PZ BICHROMATÉ
SENKKOPF-SPANPLATTENSCHRAUBE GELB VERZINKT

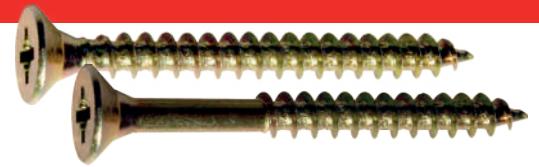
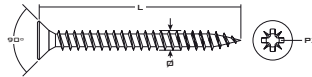

CAJA

BICROMATADO

COD.: 7505AB

PRECIO TARIFA / PRICE LIST / PRIX TARIFS **€/100 u.**

m.m.	Ø3 (PZ-1)	Ø3,5 (PZ-2)	Ø4 (PZ-2)	Ø4,5 (PZ-2)	Ø5 (PZ-2)	Ø6 (PZ-3)
12	0,77					
16	0,93					
20	1,01					
25	1,22					
30	1,41					
35						
40						
45						
50						
60						
70						
80						
90						
100						
120						
140						
160						
180						
200						

BLISTERS

BICROMATADO

CÓDIGO CODE CODE	MEDIDA SIZE MEASURE	PRECIO TARIFA PRICE LIST PRIX TARIFS
	ØxL (m.m.)	€/BLISTER
B7505AB30012	3x12	1,60
B7505AB30016	3x16	1,60
B7505AB30020	3x20	1,60
B7505AB30025	3x25	1,60
B7505AB30030	3x30	1,60
B7505AB35016	3,5x16	1,60
B7505AB35020	3,5x20	1,60
B7505AB35025	3,5x25	1,60
B7505AB35030	3,5x30	1,60
B7505AB35035	3,5x35	1,60
B7505AB35040	3,5x40	1,60
B7505AB40016	4x16	1,60
B7505AB40020	4x20	1,60
B7505AB40025	4x25	1,60
B7505AB40030	4x30	1,60
B7505AB40035	4x35	1,60
B7505AB40040	4x40	1,60
B7505AB40045	4x45	1,60
B7505AB40050	4x50	1,60
B7505AB40060	4x60	1,60
B7505AB45020	4,5x20	1,60
B7505AB45025	4,5x25	1,60
B7505AB45030	4,5x30	1,60
B7505AB45035	4,5x35	1,60
B7505AB45040	4,5x40	1,60
B7505AB45045	4,5x45	1,60
B7505AB45050	4,5x50	1,60
B7505AB45060	4,5x60	1,60

BLISTERS

BICROMATADO

CÓDIGO CODE CODE	MEDIDA SIZE MEASURE	PRECIO TARIFA PRICE LIST PRIX TARIFS
	ØxL (m.m.)	€/BLISTER
B7505AB50020	5x20	1,60
B7505AB50025	5x25	1,60
B7505AB50030	5x30	1,60
B7505AB50035	5x35	1,60
B7505AB50040	5x40	1,60
B7505AB50050	5x45	1,60
B7505AB50050	5x50	1,60
B7505AB50060	5x60	1,60
B7505AB50070	5x70	1,60
B7505AB50080	5x80	1,60
B7505AB50090	5x90	1,60
B7505AB50100	5x100	1,60
B7505AB60040	6x40	1,60
B7505AB60045	6x45	1,60
B7505AB60050	6x50	1,60
B7505AB60060	6x60	1,60
B7505AB60070	6x70	1,60
B7505AB60080	6x80	1,60
B7505AB60090	6x90	1,60
B7505AB60100	6x100	1,60

**PEDIDO MÍNIMO 1 EMBALAJE
MINIMUM ORDER 1 PACKAGING**

TORNILLO DIN 7505-A BICROMATADO PZ

CHIPBOARD SCREW PZ YELLOW ZINC PLATED
VIS À BOIS PZ BICHROMATÉ
SENKKOPF-SPANPLATTENSCHRAUBE GELB VERZINKT

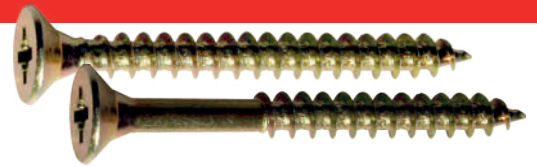
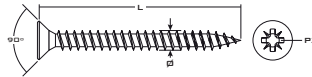

AUTOSERVICIO

BICROMATADO

CÓDIGO CODE CODE	MEDIDA SIZE MESURE ØxL (m.m.)	PRECIO TARIFA PRICE LIST PRIX TARIFS		
		☑	☑	€/BOLSA
BF7505A30016	3x16	200	12	2,72
BF7505A30020	3x20	200	12	3,05
BF7505A30025	3x25	200	12	3,69
BF7505A30030	3x30	200	12	3,80
BF7505A30040	3x40	200	12	5,38
BF7505A35016	3,5x16	200	12	3,52
BF7505A35020	3,5x20	200	12	3,75
BF7505A35025	3,5x25	200	12	4,02
BF7505A35030	3,5x30	200	12	4,58
BF7505A35035	3,5x35	150	12	4,11
BF7505A35040	3,5x40	150	12	4,50
BF7505A40016	4x16	200	12	3,99
BF7505A40020	4x20	200	12	4,37
BF7505A40025	4x25	200	12	5,19
BF7505A40030	4x30	175	12	4,92
BF7505A40035	4x35	150	12	4,75
BF7505A40040	4x40	150	12	5,35
BF7505A40045	4x45	100	12	5,80
BF7505A40050	4x50	75	12	4,32
BF7505A40060	4x60	50	12	5,13

AUTOSERVICIO

BICROMATADO

CÓDIGO CODE CODE	MEDIDA SIZE MESURE ØxL (m.m.)	PRECIO TARIFA PRICE LIST PRIX TARIFS		
		☑	☑	€/BOLSA
BF7505A45030	4,5x30	150	12	3,55
BF7505A45035	4,5x35	100	12	4,06
BF7505A45040	4,5x40	100	12	6,74
BF7505A45045	4,5x45	75	12	4,90
BF7505A45050	4,5x50	75	12	5,18
BF7505A45060	4,5x60	50	12	5,16
BF7505A45070	4,5x70	40	12	8,30
BF7505A50030	5x30	100	12	4,23
BF7505A50035	5x35	100	12	6,14
BF7505A50040	5x40	75	12	5,41
BF7505A50050	5x50	50	12	6,45
BF7505A50060	5x60	50	12	5,93
BF7505A50070	5x70	30	12	3,37
BF7505A50080	5x80	25	12	3,48
BF7505A50090	5x90	20	12	4,05
BF7505A60040	6x40	80	12	7,12
BF7505A60050	6x50	50	12	7,12
BF7505A60060	6x60	40	12	6,35
BF7505A60070	6x70	20	12	4,14
BF7505A60080	6x80	15	12	4,49
BF7505A60090	6x90	15	12	5,26
BF7505A60100	6x100	10	12	3,96

PEDIDO MÍNIMO 1 EMBALAJE / MINIMUM ORDER 1 PACKAGING
COMMANDE MINIMALE 1 EMBALLAGE / MINDESTBESTELLMENGE 1 VERPACKUNG

MALETÍN TORNILLOS DIN 7505-A BICROMATADOS PZ

YELLOW ZINC PLATED SCREW DIN 7505A BRIEFCASE / MALLETTE DE VIS BICHROMATÉ DIN 7505A
HANDKOFFER AUS SENKKOPF-SPANPLATTENSCHRAUBE GELB VERZINKT DIN 7505A



MEASURES INCLUDED IN THE BRIEFCASE / MESURES INCLUSES DANS LE MALLETTE

MEDIDA SIZE / MESURE m.m.	CANTIDAD QUANTITY QUANTITÉ	MEDIDA SIZE / MESURE m.m.	CANTIDAD QUANTITY QUANTITÉ
3x12	100	4,5x30	25
3x16	100	4,5x35	25
3x20	100	4,5x40	25
3,5x16	100	4,5x45	25
3,5x20	100	5x30	25
3,5x25	50	5x35	25
4x20	50	5x40	25
4x25	50	6x60	12
4x30	50	6x80	12
4x35	50	6x120	6
4,5x25	50		

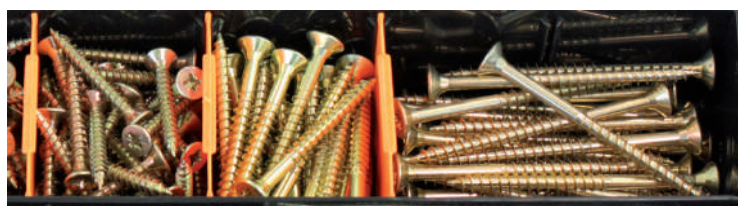

CÓDIGO CODE / CODE	DESCRIPCIÓN DESCRIPTION / DESCRIPTION
M75052	MALETÍN TORNILLO DIN 7505A BC
PRECIO TARIFA / PRICE LIST	PRECIO TARIFA / PRICE LIST
€/UNIDAD	€/100 u.
51,57	5.156,25

TORNILLO DIN 7505-A BICROMATADO PZ + TACO DE NYLON

CHIPBOARD SCREW PZ YELLOW ZINC PLATED + NYLON PLUG
VIS À BOIS PZ BICHROMATÉ + CHEVILLE NYLON
SENKKOPF-SPANPLATTENSCHRAUBE GELB VERZINKT + NYLONDÜBEL



AUTOSERVICIO

BICROMATADO

CÓDIGO CODE CODE	MEDIDA SIZE MESURE			PRECIO TARIFA PRICE LIST PRIX TARIFS
	∅xL / ∅xL (m.m.)			€/BOLSA
BF75ATN05	3,5x30 / ∅5x25	50	12	3,77
BF75ATN06	4x35 / ∅6x30	40	12	3,45
BF75ATN08	5x50 / ∅8x40	25	12	6,34
BF75ATN10	6x60 / ∅10x50	12	12	5,56

BLISTERS

BICROMATADO

CÓDIGO CODE CODE	MEDIDA SIZE MESURE			PRECIO TARIFA PRICE LIST PRIX TARIFS
	∅xL / ∅xL (m.m.)			€/BLISTER
B75ATN05	3,5x30 / ∅5x25	6	20	1,60
B75ATN06	4x35 / ∅6x30	6	20	1,60
B75ATN08	5x50 / ∅8x40	6	20	1,60
B75ATN10	6x60 / ∅10x50	2	20	1,60

TORNILLO DIN 7505-A BICROMATADO PZ + TACO DE NYLON GTX

CHIPBOARD SCREW PZ YELLOW ZINC PLATED + GTX NYLON PLUG
VIS À BOIS PZ BICHROMATÉ + CHEVILLE NYLON GTX
SENKKOPF-SPANPLATTENSCHRAUBE GELB VERZINKT + NYLONDÜBEL GTX



AUTOSERVICIO

BICROMATADO

CÓDIGO CODE CODE	MEDIDA SIZE MESURE			PRECIO TARIFA PRICE LIST PRIX TARIFS
	∅xL / ∅xL (m.m.)			€/BOLSA
BF75AG05	4x30 / ∅5x25	50	12	3,80
BF75AG06	4,5x40 / ∅6x30	40	12	5,36
BF75AG08	5x50 / ∅8x40	25	12	3,97

BLISTERS

BICROMATADO

CÓDIGO CODE CODE	MEDIDA SIZE MESURE			PRECIO TARIFA PRICE LIST PRIX TARIFS
	∅xL / ∅xL (m.m.)			€/BLISTER
B75AGT05	4x30 / ∅5x25	6	20	2,09
B75AGT06	4,5x40 / ∅6x30	6	20	2,09
B75AGT08	5x50 / ∅8x40	6	20	2,09
B75AGT10	6x60 / ∅10x50	2	20	2,09

PEDIDO MÍNIMO 1 EMBALAJE / MINIMUM ORDER 1 PACKAGING
COMMANDE MINIMALE 1 EMBALLAGE / MINDESTBESTELLMENGE 1 VERPACKUNG

TLLLO. DIN 7505-A BICROMATADO PZ + VZ

CHIPBOARD SCREW PZ YELLOW ZINC PLATED + VZ
VIS À BOIS PZ BICHROMATÉ + CHEVILLE NYLON VZ
SENKKOPF-SPANPLATTENSCHRAUBE GELB VERZINKT + VZ



AUTOSERVICIO

BICROMATADO

CÓDIGO CODE CODE	MEDIDA SIZE MESURE			PRECIO TARIFA PRICE LIST PRIX TARIFS
	∅xL / ∅xL (m.m.)			€/BOLSA
BF75AV63	4,5x45 / ∅6x32	50	12	4,37
BF75AV64	4,5x60 / ∅6x45	30	12	5,82
BF75AV84	5x50 / ∅8x42	25	12	3,46
BF75AV85	5x60 / ∅8x52	20	12	4,35
BF75AV10	6x60 / ∅10x50	12	12	5,58

MALETÍN "MTTB"

"MTTB" BRIEFCASE / MALLETTE "MTTB" / "MTTB" HANDKOFFER



BROCAS FLASH	
MEDIDA SIZE / MESURE m.m.	CANTIDAD QUANTITY QUANTITÉ
∅ 5	1
∅ 6	1
∅ 8	1
∅ 10	1

TACO NYLON GTX		TLLLO. DIN 7505-A BC	
MEDIDA SIZE / MESURE m.m.	CANTIDAD QUANTITY QUANTITÉ	MEDIDA SIZE / MESURE m.m.	CANTIDAD QUANTITY QUANTITÉ
∅ 5	100	4x30	100
∅ 6	100	4,5x40	100
∅ 8	50	5x50	50
∅ 10	25	6x60	25

CÓDIGO CODE / CODE	DESCRIPCIÓN DESCRIPTION / DESCRIPTION
-----------------------	--

MTTB2 MALETÍN CON TORNILLO, TACO Y BROCA PARA HORMIGÓN

PRECIO TARIFA / PRICE LIST	PRECIO TARIFA / PRICE LIST
€/UNIDAD	€/100 u.
51,57	5.156,25

PEDIDO MÍNIMO 1 EMBALAJE
MINIMUM ORDER 1 PACKAGING

TORNILLO DIN 7505-A AUTOOPERFORANTE BICROMATADO TX

MULTISCREW FLAT HEAD TX - YELLOW ZINC PLATED
VIS À BOIS AUTOPERCEUSE TX BICHROMATÉ
SENKKOPF-SPANPLATTENSCHRAUBE, INNENSECHSRUND,
GELB VERZINKT - BOHRSCHRAUBEN

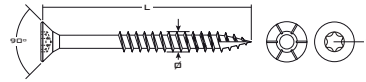

CAJA

BICROMATADO

COD.: 7505ABT

PRECIO TARIFA / PRICE LIST / PRIX TARIFS **€/100 u.**

m.m.	Ø3 (T-10)	Ø3,5 (T-15)	Ø4 (T-20)	Ø4,5 (T-20)	Ø5 (T-25)	Ø6 (T-30)	Ø8 (T-40)	Ø10 (T-50)
16	1,33	1,59	2,00					
20	1,49	1,85	2,26					
25	1,74	2,00	2,62	3,08				
30	1,95	2,26	2,92	3,44	4,37			
35		2,62	3,18	4,15	4,92			
40		3,03	3,74	4,41	5,59	7,74		
45			3,95	4,82	6,10	8,51		
50		3,59	4,41	5,49	6,36	9,33		
60			5,49	6,41	7,85	12,15		
70					8,82	15,28		
80					10,82	17,18	31,64	
90					12,67	19,23		
100					14,82	21,59	40,72	
120						26,77	51,85	
140						34,00	62,21	
160						44,77	79,13	
180						55,23	103,74	
200						64,97	127,08	
220							147,85	
240							174,62	
260							197,95	
280							218,82	
300							240,77	
340								
360								
380								
400								

CONSULTAR
PRECIO
CHECK
PRICE
VÉRIFIER
PRIX
PREIS
PRÜFEN

AUTOSERVICIO

BICROMATADO

CÓDIGO CODE CODE	MEDIDA SIZE MESURE	PRECIO TARIFA PRICE LIST PRIX TARIFS
ØxL (m.m.)	€/BOLSA	
BF7505AT30016	3x16	200 12 3,56
BF7505AT30020	3x20	200 12 3,85
BF7505AT30025	3x25	200 12 3,97
BF7505AT30030	3x30	200 12 5,47
BF7505AT35016	3,5x16	200 12 3,60
BF7505AT35020	3,5x20	200 12 3,97
BF7505AT35025	3,5x25	200 12 5,85
BF7505AT35030	3,5x30	200 12 6,23
BF7505AT35040	3,5x40	150 12 6,26
BF7505AT40016	4x16	200 12 5,59
BF7505AT40020	4x20	200 12 4,70
BF7505AT40025	4x25	200 12 5,07
BF7505AT40030	4x30	175 12 4,86
BF7505AT40035	4x35	150 12 4,75
BF7505AT40040	4x40	150 12 7,88
BF7505AT40045	4x45	100 12 8,66
BF7505AT40050	4x50	75 12 6,09
BF7505AT40060	4x60	50 12 7,66

AUTOSERVICIO

BICROMATADO

CÓDIGO CODE CODE	MEDIDA SIZE MESURE	PRECIO TARIFA PRICE LIST PRIX TARIFS
ØxL (m.m.)	€/BOLSA	
BF7505AT45030	4,5x30	150 12 5,76
BF7505AT45040	4,5x40	100 12 6,76
BF7505AT45050	4,5x50	75 12 7,43
BF7505AT45060	4,5x60	50 12 8,58
BF7505AT50035	5x35	100 12 6,74
BF7505AT50040	5x40	75 12 7,09
BF7505AT50050	5x50	50 12 10,86
BF7505AT50060	5x60	50 12 10,36
BF7505AT50070	5x70	30 12 4,58
BF7505AT50080	5x80	25 12 4,66
BF7505AT50090	5x90	20 12 5,70
BF7505AT60060	6x60	40 12 7,57
BF7505AT60070	6x70	20 12 5,60
BF7505AT60080	6x80	15 12 6,12
BF7505AT60090	6x90	15 12 7,78
BF7505AT60100	6x100	10 12 6,16

PEDIDO MÍNIMO 1 EMBALAJE / MINIMUM ORDER 1 PACKAGING
COMMANDE MINIMALE 1 EMBALLAGE / MINDESTBESTELLMENGE 1 VERPACKUNG

TORNILLO DIN 7505-A AUTOPERFORANTE CINCADO PZ

SELF-DRILLING CHIPBOARD SCREW PZ ZINC PLATED
VIS À BOIS PZ AUTOPERCEUSE EN ACIER ZINGUÉ
SENKKOPF-SPANPLATTENSCHRAUBE VERZINKT - BOHRSCHRAUBEN

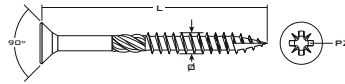

CAJA

CINCADO

COD.: MULTI+

PRECIO TARIFA / PRICE LIST / PRIX TARIFS €100 u.

m.m.	Ø3 (PZ-1)	Ø3,5 (PZ-2)	Ø4 (PZ-2)	Ø4,5 (PZ-2)	Ø5 (PZ-2)	Ø6 (PZ-3)
13	1,45	1,70				
15	1,47	1,85	2,16			
17	1,60	1,88	2,32			
20	1,85	2,16	2,50	3,10	3,97	
25	1,97	2,47	2,94	3,47	4,38	
30	2,16	2,70	3,29	3,97	5,10	7,82
35	2,47	3,10	3,60	4,69	5,75	
40	2,79	3,47	3,97	5,22	6,50	9,25
45		3,75	4,38	5,72	7,04	
50		4,22	4,85	6,13	7,66	10,94
60			5,97	7,41	9,00	13,10
70			6,94	8,63	10,72	15,97
80				10,25	12,29	18,00
90					14,88	
100					16,32	22,85
120					20,75	28,25
130						32,62
140						35,49
150						38,62
160						46,41
180						58,10
200						68,31

NUEVO PRODUCTO / NEW PRODUCT / NOUVEAU PRODUIT

TORNILLO DIN 7505-B CINCADO PZ

CHIPBOARD SCREW PZ ZINC PLATED
VIS À BOIS PZ EN ACIER ZINGUÉ
SENKKOPF-SPANPLATTENSCHRAUBE VERZINKT

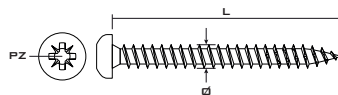

CAJA

CINCADO

COD.: 7505BZ

PRECIO TARIFA / PRICE LIST / PRIX TARIFS €100 u.

m.m.	Ø3,5 (PZ-2)	Ø4 (PZ-2)	Ø4,5 (PZ-2)	Ø5 (PZ-2)	Ø6 (PZ-3)
16	1,55	1,98			
20	1,69	2,22	2,75	3,47	
25	1,98	2,46	3,08	4,00	
30	2,22	2,70	3,44	4,50	
35		3,08	3,88	4,97	
40		3,35	4,16	5,32	7,94
45			4,60		
50			4,88		9,10
60					11,50

TORNILLO BARRAQUERO DIN 571 CINCADO

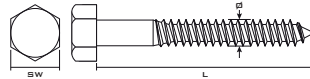
 HEXAGONAL HEAD WOOD SCREW ZINC PLATED
 TIREFOND À VISSEUR AVEC TÊTE HEXAGONALE EN ACIER ZINGUÉ
 SECHSKANT-HOLZSCHRAUBE VERZINKT

CAJA
CINCADO

COD.: 571Z

 PRECIO TARIFA / PRICE LIST / PRIX TARIFS **€/100 u.**

m.m.	∅5 (SW-8)	∅6 (SW-10)	∅7 (SW-12)	∅8 (SW-13)	∅10 (SW-17)	∅12 (SW-19)
25	2,79	4,14				
30	3,64	4,54		8,67		
35	3,94	5,00		9,97		
40	4,14	5,64		10,72		
45		6,64		11,79		
50	4,97	6,84	12,50	12,50	22,07	31,16
60	7,20	7,94	13,60	14,50	25,16	35,60
70		8,67	13,94	16,47	29,44	39,69
80		9,80		19,25	32,04	43,97
90		10,97	16,64	20,63	34,25	48,82
100		12,67	17,75	22,00	37,10	53,00
110			21,85	24,25	39,97	
120			24,07	27,47	42,75	61,47
130				40,00	62,58	89,07
140			28,44	44,00	70,00	95,57
150				55,00	82,00	116,00
160				56,67	85,00	120,00
180				61,80	88,13	127,60
200				66,67	93,67	134,07

BLISTERS
CINCADO

CÓDIGO CODE CODE	MEDIDA SIZE MEASURE	PRECIO TARIFA PRICE LIST PRIX TARIFS
	∅xL (m.m.)	€/BLISTER
B571Z05025	5x25	1,60
B571Z05030	5x30	1,60
B571Z05035	5x35	1,60
B571Z05040	5x40	1,60
B571Z05050	5x50	1,60
B571Z06025	6x25	1,60
B571Z06030	6x30	1,60
B571Z06035	6x35	1,60
B571Z06040	6x40	1,60
B571Z06050	6x50	1,60
B571Z06060	6x60	1,60
B571Z06070	6x70	1,60
B571Z06080	6x80	1,60
B571Z06090	6x90	1,60
B571Z06100	6x100	1,60
B571Z07040	7x40	1,60
B571Z07050	7x50	1,60
B571Z07060	7x60	1,60

BLISTERS
CINCADO

CÓDIGO CODE CODE	MEDIDA SIZE MEASURE	PRECIO TARIFA PRICE LIST PRIX TARIFS
	(∅xL) m.m.	€/BLISTER
B571Z07070	7x70	1,60
B571Z07080	7x80	1,60
B571Z07090	7x90	1,60
B571Z07100	7x100	1,60
B571Z08040	8x40	1,60
B571Z08045	8x45	1,60
B571Z08050	8x50	1,60
B571Z08060	8x60	1,60
B571Z08070	8x70	1,60
B571Z08080	8x80	1,60
B571Z08090	8x90	1,60
B571Z08100	8x100	1,60
B571Z10050	10x50	1,60
B571Z10060	10x60	1,60
B571Z10070	10x70	1,60
B571Z10080	10x80	1,60
B571Z10090	10x90	1,60
B571Z10100	10x100	1,60

PEDIDO MÍNIMO 1 EMBALAJE / MINIMUM ORDER 1 PACKAGING
COMMANDE MINIMALE 1 EMBALLAGE / MINDESTBESTELLMENGE 1 VERPACKUNG

TORNILLO BARRAQUERO DIN 571 CINCADO

HEXAGONAL HEAD WOOD SCREW ZINC PLATED
TIREFOND À VISSER AVEC TÊTE HEXAGONALE EN ACIER ZINGUÉ
SECHSKANT-HOLZSCHRAUBE VERZINKT



AUTOSERVICIO

CÓDIGO CODE CODE	MEDIDA SIZE MESURE	CINCADO		PRECIO TARIFA PRICE LIST PRIX TARIFS
	∅xL (m.m.)			€/BOLSA
BF57105040	5x40	50	12	3,28
BF57105050	5x50	40	12	3,85
BF57106040	6x40	40	12	4,00
BF57106050	6x50	35	12	3,75
BF57106060	6x60	25	12	3,33
BF57107050	7x50	25	12	3,58
BF57107060	7x60	20	12	3,41
BF57107070	7x70	20	12	3,69
BF57107080	7x80	15	12	3,89

AUTOSERVICIO

CÓDIGO CODE CODE	MEDIDA SIZE MESURE	CINCADO		PRECIO TARIFA PRICE LIST PRIX TARIFS
	∅xL (m.m.)			€/BOLSA
BF57108050	8x50	20	12	3,40
BF57108060	8x60	15	12	3,88
BF57108070	8x70	15	12	4,44
BF57108080	8x80	12	12	3,72
BF57108090	8x90	10	12	2,79
BF57108100	8x100	10	12	3,01
BF57110070	10x70	10	12	3,78
BF57110080	10x80	10	12	4,01
BF57110090	10x90	8	12	4,66
BF57110100	10x100	8	12	4,91

PEDIDO MÍNIMO 1 EMBALAJE / MINIMUM ORDER 1 PACKAGING
COMMANDE MINIMALE 1 EMBALLAGE / MINDESTBESTELLMENGE 1 VERPACKUNG

TLLLO. DIN 571 CINCADO + TACO DE NYLON GTX

HEXAGONAL HEAD WOOD SCREW ZINC PLATED + GTX NYLON PLUG
TIREFOND À VISSER AVEC TÊTE HEXAGONALE ZINGUÉ + GTX
SECHSKANT-HOLZSCHRAUBE VERZINKT + NYLONDÜBEL GTX



BLISTERS

CÓDIGO CODE CODE	MEDIDA SIZE MESURE	CINCADO		PRECIO TARIFA PRICE LIST PRIX TARIFS
	∅xL / ∅xL (m.m.)			€/BLISTER
B571GT06	4,5x40 / ∅6x30	6	20	2,09
B571GT08	5x50 / ∅8x40	6	20	2,09
B571GT10	6x60 / ∅10x50	4	20	2,09

TLLLO. DIN 571 CINCADO + TACO DE NYLON VZ

CHIPBOARD SCREW PZ YELLOW ZINC PLATED + VZ NYLON PLUG
VIS À BOIS PZ BICHROMATÉ + CHEVILLE NYLON VZ
SENKKOPF-SPANPLATTENSCHRAUBE GELB VERZINKT + VZ



AUTOSERVICIO

CÓDIGO CODE CODE	MEDIDA SIZE MESURE	CINCADO		PRECIO TARIFA PRICE LIST PRIX TARIFS
	∅xL / ∅xL (m.m.)			€/BOLSA
BF571V84	5x50 / ∅8x42	25	12	4,46
BF571V85	5x60 / ∅8x52	20	12	5,48
BF571V10	6x60 / ∅10x50	12	12	5,38
BF571V12	7x70 / ∅12x60	8	12	5,38

PEDIDO MÍNIMO 1 EMBALAJE / MINIMUM ORDER 1 PACKAGING
COMMANDE MINIMALE 1 EMBALLAGE / MINDESTBESTELLMENGE 1 VERPACKUNG

INSTALACIÓN

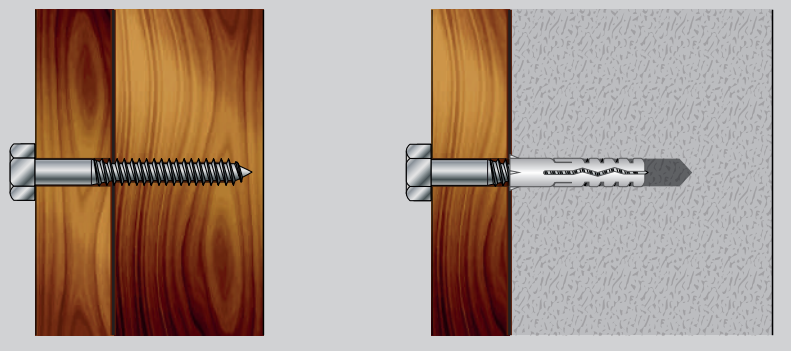

ESPÁRRAGO DOBLE ROSCA TX CINCADO

ZINC PLATED DOWEL THREAD SCREW WITH TORX HEAD
VIS COMBI AVEC SECTION HEXAGONAL TORX EN ACIER ZINGUÉ
VERZINKTE SCHRAUBE MIT DOPPELTEM GEWINDE

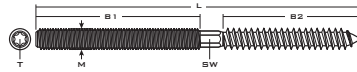

CAJA

CÓDIGO CODE CODE	MEDIDA SIZE MEASURE (MxL) m.m.	SW m.m.	LLAVE KEY CLÉ	B1 m.m.	B2 m.m.	CINCO	CINCADO	
							PRECIO TARIFA PRICE LIST PRIX TARIFS	€/100 u.
EDRT08080	8x80	6	T-25	30	40	100		17,19
EDRT08090	8x90	6	T-25	30	40	100		18,44
EDRT08100	8x100	6	T-25	40	47	100		20,00
EDRT08120	8x120	6	T-25	50	50	100		28,10
EDRT08150	8x150	6	T-25	50	50	100		34,69
EDRT08160	8x160	6	T-25	50	50	100		37,16
EDRT08180	8x180	6	T-25	50	50	100		42,35
EDRT10060	10x60	8	T-25	17	30	100		21,19
EDRT10080	10x80	8	T-25	30	40	100		26,52
EDRT10100	10x100	8	T-25	30	60	50		31,88
EDRT10120	10x120	8	T-25	40	60	50		44,35
EDRT10140	10x140	8	T-25	50	60	50		56,25
EDRT10160	10x160	8	T-25	50	60	50		63,72
EDRT10180	10x180	8	T-25	50	60	50		81,25
EDRT10200	10x200	8	T-25	50	60	50		90,63

INSTALACIÓN

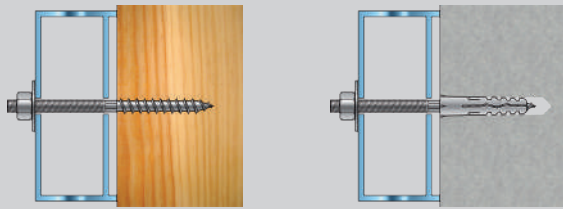

TORNILLO ABRAZADERA DOBLE ROSCA CINCADO

DOUBLE THREADED SCREW ZINC PLATED
VIS POUR COLLIER ET CRAMPON ZINGUÉ
VERZINKTE VERBINDUNGSSCHRAUBE MIT DOPPELTEM GEWINDE

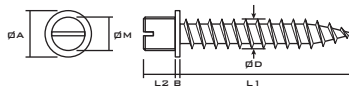

CAJA

CÓDIGO CODE CODE	MEDIDA SIZE MEASURE m.m.	CINCO	CINCADO	
			PRECIO TARIFA PRICE LIST PRIX TARIFS	€/100 u.
DRZ630	6x30	100		5,63
DRZ640	6x40	100		7,00
DRZ840	8x40	100		11,74

AUTOSERVICIO

CÓDIGO CODE CODE	MEDIDA SIZE MEASURE m.m.	CINCO		PRECIO TARIFA PRICE LIST PRIX TARIFS €/BOLSA
		30	35	
BFDR630	6x30	40	12	2,25
BFDR640	6x40	30	12	2,35
BFDR840	8x40	20	12	2,86

BLISTERS

CÓDIGO CODE CODE	MEDIDA SIZE MEASURE m.m.	CINCO		PRECIO TARIFA PRICE LIST PRIX TARIFS €/BLISTER
		8	12	
BDRZ630	6x30	8	12	1,60
BDRZ640	6x40	8	12	1,60
BDRZ840	8x40	8	12	1,60

PEDIDO MÍNIMO 1 EMBALAJE / MINIMUM ORDER 1 PACKAGING
COMMANDE MINIMALE 1 EMBALLAGE / MINDESTBESTELLMENGE 1 VERPACKUNG

TORNILLO INVOLABLE ROSCA MADERA CINCADO TX

MUSHROOM HEAD GLOBE-RECESS WOOD SCREW ZINC PLATED
VIS À BOIS TÊTE BOMBÉE À SIX LOBES EN ACIER ZINGUÉ
RUNDKOPF-HOLZSCHRAUBE MIT INNERSECHSRUND VERZINKT



CAJA

CÓDIGO CODE CODE	MEDIDA SIZE MESURE (ϕ xL) m.m.	LLAVE KEY CLÉ	CINCADO		PRECIO TARIFA PRICE LIST PRIX TARIFS €/100 U.
TITMZ07060	7x60	T-40	100	600	30,84
TITMZ07070	7x70	T-40	100	600	35,56
TITMZ07085	7x85	T-40	100	600	43,75
TITMZ07105	7x105	T-40	100	600	50,44
TITMZ07120	7x120	T-40	100	600	57,30
TITMZ07140	7x140	T-40	100	600	76,07
TITMZ07165	7x165	T-40	100	600	91,19

AUTOSERVICIO

CÓDIGO CODE CODE	MEDIDA SIZE MESURE (ϕ xL) m.m.	CINCADO		PRECIO TARIFA PRICE LIST PRIX TARIFS €/BOLSA
BFTITMZ7060	7x60	15	12	5,86
BFTITMZ7070	7x70	15	12	5,90
BFTITMZ7085	7x85	12	12	9,69
BFTITMZ7105	7x105	10	12	6,66

BLISTERS

CÓDIGO CODE CODE	MEDIDA SIZE MESURE (ϕ xL) m.m.	CINCADO		PRECIO TARIFA PRICE LIST PRIX TARIFS €/BLISTER
BTITMZ7060	7x60	2	20	2,09
BTITMZ7085	7x85	2	20	2,09
BTITMZ7105	7x105	2	20	2,09
BTITMZ7120	7x120	2	15	2,09

PEDIDO MÍNIMO 1 EMBALAJE / MINIMUM ORDER 1 PACKAGING
COMMANDE MINIMALE 1 EMBALLAGE / MINDESTBESTELLMENGE 1 VERPACKUNG

TORNILLO ROSCA MADERA CINCADO NEGRO TX

MUSHROOM HEAD GLOBE-RECESS WOOD SCREW BLACK ZINC PLATED
VIS À BOIS TÊTE BOMBÉE À SIX LOBES EN ACIER ZINGUÉ NOIR
RUNDKOPF-HOLZSCHRAUBE MIT INNERSECHSRUND SCHWARZ VERZINKT

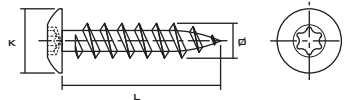

CAJA

CÓDIGO CODE CODE	MEDIDA SIZE MESURE (ϕ xL) m.m.	K m.m.	LLAVE KEY CLÉ	CINCADO NEGRO		PRECIO TARIFA PRICE LIST PRIX TARIFS €/100 U.
TTMNO6020	6x20	15	T-30	200		10,54
TTMNO6025	6x25	15	T-30	200		11,67
TTMNO6030	6x30	15	T-30	200		12,67
TTMNO6035	6x35	15	T-30	200		13,90
TTMNO6040	6x40	15	T-30	200		15,10
TTMNO6050	6x50	15	T-30	200		17,34
TTMNO7040	7x40	17	T-30	200		21,34
TTMNO7050	7x50	17	T-30	200		25,40
TTMNO7060	7x60	17	T-30	200		28,84
TTMNO7070	7x70	17	T-30	200		32,94

AUTOSERVICIO

CÓDIGO CODE CODE	MEDIDA SIZE MESURE (ϕ xL) m.m.	CINCADO NEGRO		PRECIO TARIFA PRICE LIST PRIX TARIFS €/BOLSA
BFTTMNO6020	6x20	50	12	8,93
BFTTMNO6025	6x25	50	12	7,24
BFTTMNO6030	6x30	50	12	10,56
BFTTMNO6040	6x40	50	12	12,47

AUTOSERVICIO

CÓDIGO CODE CODE	MEDIDA SIZE MESURE (ϕ xL) m.m.	CINCADO NEGRO		PRECIO TARIFA PRICE LIST PRIX TARIFS €/BOLSA
BFTTMNO6050	6x50	30	12	8,82
BFTTMNO7040	7x40	25	12	9,51
BFTTMNO7060	7x60	15	12	7,49
BFTTMNO7070	7x70	15	12	8,44

PEDIDO MÍNIMO 1 EMBALAJE / MINIMUM ORDER 1 PACKAGING
COMMANDE MINIMALE 1 EMBALLAGE / MINDESTBESTELLMENGE 1 VERPACKUNG

TORNILLO FOSFATADO PARA CARTÓN-YESO

PHOSPHATED DRY WALL SCREW FOR PLASTERBOARD
VIS POUR PLAQUES DE PLÂTRE EN ACIER PHOSPHATÉ
PHOSPHATIERTE SCHWARZE TROPETEKOPFSCHRAUBE FÜR GIPSKARTON



CAJA

CÓDIGO CODE CODE	MEDIDA SIZE MESURE (ØxL) m.m.	LLAVE KEY CLÉ PH	FOSFATADO		PRECIO TARIFA PRICE LIST PRIX TARIFS €/100 u.
PLADUR35025	3,5x25	2	1.000	16.000	1,41
PLADUR35035	3,5x35	2	1.000	12.000	1,86
PLADUR35045	3,5x45	2	1.000	8.000	2,30

AUTOSERVICIO

CÓDIGO CODE CODE	MEDIDA SIZE MESURE (ØxL) m.m.	FOSFATADO		PRECIO TARIFA PRICE LIST PRIX TARIFS €/BOLSA
BFPLADUR35025	3,5x25	100	12	2,64
BFPLADUR35035	3,5x35	100	12	3,49
BFPLADUR35045	3,5x45	100	12	3,64

BLISTERS

CÓDIGO CODE CODE	MEDIDA SIZE MESURE (ØxL) m.m.	FOSFATADO		PRECIO TARIFA PRICE LIST PRIX TARIFS €/BLISTER
BPLADUR35025	3,5x25	50	10	2,09
BPLADUR35035	3,5x35	40	10	2,09
BPLADUR35045	3,5x45	25	10	2,09

PEDIDO MÍNIMO 1 EMBALAJE / MINIMUM ORDER 1 PACKAGING
COMMANDE MINIMALE 1 EMBALLAGE / MINDESTBESTELLMENGE 1 VERPACKUNG

NUEVO PRODUCTO / NEW PRODUCT / NOUVEAU PRODUIT

TORNILLO AUTOPERFORANTE FOSFATADO PARA CARTÓN-YESO

SELF-DRILLING PHOSPHATED DRY WALL SCREW FOR PLASTERBOARD
VIS AUTOPERCEUSE POUR PLAQUES DE PLÂTRE EN ACIER PHOSPHATÉ
PHOSPHATIERTE SCHWARZE TROPETEKOPFSCHRAUBE FÜR GIPSKARTON

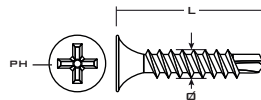

CAJA

CÓDIGO CODE CODE	MEDIDA SIZE MESURE (ØxL) m.m.	LLAVE KEY CLÉ PH	FOSFATADO		PRECIO TARIFA PRICE LIST PRIX TARIFS €/100 u.
PLADURA35025	3,5x25	2	1.000	16.000	1,67
PLADURA35035	3,5x35	2	1.000	12.000	2,08
PLADURA35045	3,5x45	2	1.000	8.000	2,68

AUTOSERVICIO

CÓDIGO CODE CODE	MEDIDA SIZE MESURE (ØxL) m.m.	FOSFATADO		PRECIO TARIFA PRICE LIST PRIX TARIFS €/BOLSA
BFPA35025	3,5x25	100	12	3,80
BFPA35035	3,5x35	100	12	4,07
BFPA35045	3,5x45	100	12	5,17

PEDIDO MÍNIMO 1 EMBALAJE
MINIMUM ORDER 1 PACKAGING

CÁNCAMO CERRADO CINCADO

EYE WOOD SCREW ZINC PLATED
VIS OEILLET À BOIS EN ACIER ZINGUÉ
HOLZ-AUGENSCHRAUBE VERZINKT

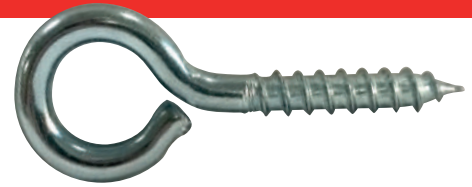
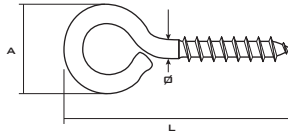

CAJA

CÓDIGO CODE CODE	MEDIDA SIZE MESURE	A	Ø	L	CINCADO	
					PRECIO TARIFA PRICE LIST PRIX TARIFS	PRECIO TARIFA PRICE LIST PRIX TARIFS
CCZ14025	14x25	9	2	20	500	2,47
CCZ14030	14x30	9	2	23	500	2,80
CCZ16030	16x30	10	2,5	23	300	2,80
CCZ16035	16x35	10	2,5	25	300	3,30
CCZ17035	17x35	11	2,7	24	300	3,70
CCZ17040	17x40	11	2,7	27	300	3,96
CCZ17050	17x50	13	2,7	33	300	4,34
CCZ17060	17x60	13	2,7	36	300	5,85
CCZ18040	18x40	13	3	29	300	4,46
CCZ18045	18x45	13	3	32	300	4,80
CCZ18050	18x50	13	3	34	300	4,85
CCZ18060	18x60	13	3	37	200	6,23
CCZ19050	19x50	14	3,5	34	200	6,50
CCZ19060	19x60	16	3,5	40	200	6,78
CCZ19070	19x70	17	3,5	45	200	7,58
CCZ19080	19x80	17	3,5	50	200	10,80

CÓDIGO CODE CODE	MEDIDA SIZE MESURE	A	Ø	L	CINCADO	
					PRECIO TARIFA PRICE LIST PRIX TARIFS	PRECIO TARIFA PRICE LIST PRIX TARIFS
CCZ20050	20x50	17	4	39	200	7,34
CCZ20060	20x60	17	4	41	200	8,57
CCZ20070	20x70	18	4	45	200	9,18
CCZ20080	20x80	18	4	51	200	10,29
CCZ20090	20x90	21	4	57	100	13,65
CCZ21070	21x70	20	4,5	48	200	11,47
CCZ21080	21x80	21	4,5	54	100	12,50
CCZ21090	21x90	21	4,5	60	100	13,97
CCZ21100	21x100	21	4,5	64	100	15,13
CCZ22080	22x80	23	4,5	55	100	17,49
CCZ22090	22x90	23	4,5	65	100	18,26
CCZ22100	22x100	23	5	70	100	22,35
CCZ22120	22x120	25	5	77	100	23,66
CCZ23120	*23x120	26	5,5	75	-	34,35
CCZ23130	*23x130	29	5,5	90	-	37,57
CCZ23140	23x140	30	5,5	98	50	40,85
CCZ23150	23x150	30	5,5	108	50	43,69

*HASTA AGOTAR EXISTENCIAS

BLISTERS

CÓDIGO CODE CODE	MEDIDA SIZE MESURE	CINCADO		PRECIO TARIFA PRICE LIST PRIX TARIFS
		PRECIO TARIFA PRICE LIST PRIX TARIFS	PRECIO TARIFA PRICE LIST PRIX TARIFS	
BCCZ14025	14x25	25	20	1,60
BCCZ16030	16x30	15	20	1,60
BCCZ17040	17x40	15	20	1,60
BCCZ18040	18x40	15	20	1,60
BCCZ18050	18x50	15	20	1,60
BCCZ19050	19x50	10	20	1,60
BCCZ19060	19x60	10	20	1,60
BCCZ19070	19x70	10	20	1,60

BLISTERS

CÓDIGO CODE CODE	MEDIDA SIZE MESURE	CINCADO		PRECIO TARIFA PRICE LIST PRIX TARIFS
		PRECIO TARIFA PRICE LIST PRIX TARIFS	PRECIO TARIFA PRICE LIST PRIX TARIFS	
BCCZ20050	20x50	8	20	1,60
BCCZ20060	20x60	8	20	1,60
BCCZ20070	20x70	8	20	1,60
BCCZ20080	20x80	8	20	1,60
BCCZ21070	21x70	6	20	1,60
BCCZ21080	21x80	6	20	1,60
BCCZ21090	21x90	4	20	1,60
BCCZ21100	21x100	4	20	1,60

PEDIDO MÍNIMO 1 EMBALAJE / MINIMUM ORDER 1 PACKAGING
COMMANDE MINIMALE 1 EMBALLAGE / MINDESTBESTELLMENGE 1 VERPACKUNG

CÁNCAMO CERRADO CINCADO + TACO DE NYLON GTX

EYE WOOD SCREW ZINC PLATED + GTX NYLON PLUG
VIS OEILLET À BOIS EN ACIER ZINGUÉ + CHEVILLE NYLON GTX
HOLZ-AUGENSCHRAUBE VERZINKT + NYLONDÜBEL GTX



AUTOSERVICIO

CÓDIGO CODE CODE	MEDIDA SIZE MESURE	CINCADO		PRECIO TARIFA PRICE LIST PRIX TARIFS
		PRECIO TARIFA PRICE LIST PRIX TARIFS	PRECIO TARIFA PRICE LIST PRIX TARIFS	
BFCCZG05	19x70 / Ø5x25	25	12	3,82
BFCCZG06	20x80 / Ø6x30	20	12	4,32
BFCCZG08	21x100 / Ø8x40	10	12	3,33

BLISTERS

CÓDIGO CODE CODE	MEDIDA SIZE MESURE	CINCADO		PRECIO TARIFA PRICE LIST PRIX TARIFS
		PRECIO TARIFA PRICE LIST PRIX TARIFS	PRECIO TARIFA PRICE LIST PRIX TARIFS	
BCCZGT05	19x70 / Ø5x25	6	20	2,09
BCCZGT06	20x80 / Ø6x30	6	20	2,09
BCCZGT08	21x100 / Ø8x40	4	20	2,09

PEDIDO MÍNIMO 1 EMBALAJE / MINIMUM ORDER 1 PACKAGING
COMMANDE MINIMALE 1 EMBALLAGE / MINDESTBESTELLMENGE 1 VERPACKUNG

CÁNCAMO ABIERTO CINCADO

HOOK WOOD SCREW ZINC PLATED
VIS CROCHER ROND À BOIS EN ACIER ZINGUÉ
HOLZSCHRAUBE MIT RUNDHAKEN VERZINKT

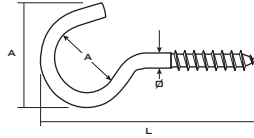

CAJA

CÓDIGO CODE CODE	MEDIDA SIZE MESURE	A	Ø	L	CINCADO	
					PRECIO TARIFA PRICE LIST PRIX TARIFS	PRECIO TARIFA PRICE LIST PRIX TARIFS
CAZ14025	14x25	9	2	21	500	2,47
CAZ14030	14x30	9	2	24	500	2,80
CAZ16030	16x30	10	2,5	25	300	2,80
CAZ16035	16x35	10	2,5	27	300	3,30
CAZ17035	17x35	12	2,7	25	300	3,70
CAZ17040	17x40	12	2,7	29	300	3,96
CAZ17050	17x50	14	2,7	35	300	4,34
CAZ18040	18x40	14	3	30	300	4,45
CAZ18045	18x45	14	3	33	300	4,80
CAZ18050	18x50	14	3	36	300	4,85
CAZ18060	18x60	17	3	41	200	6,23
CAZ18070	18x70	20	3	45	200	6,50
CAZ19050	19x50	16	3,5	34	200	6,50
CAZ19060	19x60	17	3,5	42	200	6,78
CAZ19070	19x70	21	3,5	50	200	7,58
CAZ19080	19x80	25	3,5	53	200	10,80

CÓDIGO CODE CODE	MEDIDA SIZE MESURE	A	Ø	L	CINCADO	
					PRECIO TARIFA PRICE LIST PRIX TARIFS	PRECIO TARIFA PRICE LIST PRIX TARIFS
CAZ20050	20x50	17	4	34	200	7,34
CAZ20060	20x60	20	4	42	200	8,23
CAZ20070	20x70	22	4	47	200	9,18
CAZ20080	20x80	26	4	53	200	10,29
CAZ20090	20x90	28	4	58	100	13,65
CAZ21070	21x70	26	4,5	54	200	11,47
CAZ21080	21x80	26	4,5	58	100	12,50
CAZ21090	21x90	30	4,5	60	100	13,97
CAZ21100	21x100	33	5	84	100	15,13
CAZ22100	22x100	27	5,5	60	100	22,35
CAZ22120	22x120	33	5,5	77	100	23,66
CAZ23120	23x120	35	5,5	87	100	34,35
CAZ23130	23x130	39	5,5	90	50	37,57
CAZ23140	23x140	39	5,5	100	50	40,85
CAZ23150	23x150	39	5,5	110	50	43,69

*HASTA AGOTAR EXISTENCIAS

BLISTERS

CÓDIGO CODE CODE	MEDIDA SIZE MESURE	CINCADO		PRECIO TARIFA PRICE LIST PRIX TARIFS
		PRECIO TARIFA PRICE LIST PRIX TARIFS	PRECIO TARIFA PRICE LIST PRIX TARIFS	
BCAZ14025	14x25	25	20	1,60
BCAZ16030	16x30	15	20	1,60
BCAZ17040	17x40	15	20	1,60
BCAZ18040	18x40	15	20	1,60
BCAZ18050	18x50	15	20	1,60
BCAZ19050	19x50	10	20	1,60
BCAZ19060	19x60	10	20	1,60
BCAZ19070	19x70	10	20	1,60

BLISTERS

CÓDIGO CODE CODE	MEDIDA SIZE MESURE	CINCADO		PRECIO TARIFA PRICE LIST PRIX TARIFS
		PRECIO TARIFA PRICE LIST PRIX TARIFS	PRECIO TARIFA PRICE LIST PRIX TARIFS	
BCAZ20050	20x50	8	20	1,60
BCAZ20060	20x60	8	20	1,60
BCAZ20070	20x70	8	20	1,60
BCAZ20080	20x80	8	20	1,60
BCAZ21070	21x70	6	20	1,60
BCAZ21080	21x80	6	20	1,60
BCAZ21090	21x90	4	20	1,60
BCAZ21100	21x100	4	20	1,60

PEDIDO MÍNIMO 1 EMBALAJE / MINIMUM ORDER 1 PACKAGING
COMMANDE MINIMALE 1 EMBALLAGE / MINDESTBESTELLMENGE 1 VERPACKUNG

CÁNCAMO ABIERTO CINCADO + TACO DE NYLON GTX

HOOK WOOD SCREW ZINC PLATED + GTX NYLON PLUG
VIS CROCHER ROND À BOIS EN ACIER ZINGUÉ + CHEVILLE NYLON GTX
HOLZSCHRAUBE MIT RUNDHAKEN VERZINKT + NYLONDÜBEL GTX



AUTOSERVICIO

CÓDIGO CODE CODE	MEDIDA SIZE MESURE	CINCADO		PRECIO TARIFA PRICE LIST PRIX TARIFS
		PRECIO TARIFA PRICE LIST PRIX TARIFS	PRECIO TARIFA PRICE LIST PRIX TARIFS	
BFCAZG05	19x70 / Ø5x25	25	12	3,51
BFCAZG06	20x80 / Ø6x30	20	12	4,32
BFCAZG08	21x100 / Ø8x40	10	12	3,33

BLISTERS

CÓDIGO CODE CODE	MEDIDA SIZE MESURE	CINCADO		PRECIO TARIFA PRICE LIST PRIX TARIFS
		PRECIO TARIFA PRICE LIST PRIX TARIFS	PRECIO TARIFA PRICE LIST PRIX TARIFS	
BCAZGT05	19x70 / Ø5x25	6	20	2,09
BCAZGT06	20x80 / Ø6x30	6	20	2,09
BCAZGT08	21x100 / Ø8x40	4	20	2,09

PEDIDO MÍNIMO 1 EMBALAJE / MINIMUM ORDER 1 PACKAGING
COMMANDE MINIMALE 1 EMBALLAGE / MINDESTBESTELLMENGE 1 VERPACKUNG

ALCAYATA ROSCADA CINCADA

"L" SHAPED WOOD SCREW ZINC PLATED
VIS CROCHET DROIT À BOIS EN ACIER ZINGUÉ
HOLZSCHRAUBE HAKEN VERZINKT

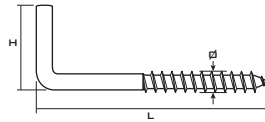

CAJA

CÓDIGO CODE CODE	MEDIDA SIZE MESURE	Ø	H	L	Caja	CINCADO	
						PRECIO TARIFA PRICE LIST PRIX TARIFS	€/100 u.
AZ14025	14x25	2	10	17	500	2,47	
AZ16030	16x30	2,5	12	21	300	2,80	
AZ17035	17x35	2,7	13	25	300	3,70	
AZ17040	17x40	2,7	14	29	300	3,96	
AZ18040	18x40	3	14	30	300	4,45	
AZ18050	18x50	3	16	36	300	4,85	
AZ19050	19x50	3,5	16	34	200	6,50	
AZ19060	19x60	3,5	18	42	200	6,78	
AZ19070	19x70	3,5	20	50	200	7,59	
AZ20050	20x50	4	16	34	200	7,34	
AZ20060	20x60	4	18	42	200	8,23	
AZ20070	20x70	4	20	47	200	9,18	
AZ20080	20x80	4	22	53	200	10,29	
AZ21070	21x70	4,5	20	48	200	11,47	
AZ21080	21x80	4,5	22	54	100	12,50	
AZ21090	21x90	4,5	24	58	100	13,97	
AZ21100	21x100	4,5	26	60	100	15,13	
AZ22080	22x80	5	25	56	100	17,49	
AZ22100	22x100	5	25	70	100	22,35	

BLISTERS

CÓDIGO CODE CODE	MEDIDA SIZE MESURE	Blister	Caja	CINCADO	
				PRECIO TARIFA PRICE LIST PRIX TARIFS	€/BLISTER
BAZ14025	14x25	25	20	1,60	
BAZ16030	16x30	15	20	1,60	
BAZ17040	17x40	15	20	1,60	
BAZ18040	18x40	15	20	1,60	
BAZ18050	18x50	15	20	1,60	
BAZ19050	19x50	10	20	1,60	
BAZ19060	19x60	10	20	1,60	
BAZ19070	19x70	10	20	1,60	

BLISTERS

CÓDIGO CODE CODE	MEDIDA SIZE MESURE	Blister	Caja	CINCADO	
				PRECIO TARIFA PRICE LIST PRIX TARIFS	€/BLISTER
BAZ20060	20x60	8	20	1,60	
BAZ20070	20x70	6	20	1,60	
BAZ20080	20x80	6	20	1,60	
BAZ21080	21x80	4	20	1,60	
BAZ21090	21x90	2	20	1,60	
BAZ21100	21x100	2	20	1,60	

PEDIDO MÍNIMO 1 EMBALAJE / MINIMUM ORDER 1 PACKAGING
COMMANDE MINIMALE 1 EMBALLAGE / MINDESTBESTELLMENGE 1 VERPACKUNG

ALCAYATA ROSCADA CINCADA + TACO DE NYLON GTX

"L" SHAPED WOOD SCREW ZINC PLATED + GTX NYLON PLUG
VIS CROCHET DROIT À BOIS EN ACIER ZINGUÉ + CHEVILLE NYLON GTX
HOLZSCHRAUBE HAKEN VERZINKT + NYLÖDÜBEL GTX



AUTOSERVICIO

CÓDIGO CODE CODE	MEDIDA SIZE MESURE	Blister	Caja	CINCADO	
				PRECIO TARIFA PRICE LIST PRIX TARIFS	€/BOLSA
BFAZG05	19x70 / Ø5x25	25	12	3,51	
BFAZG06	20x80 / Ø6x30	20	12	4,32	
BFAZG08	21x100 / Ø8x40	10	12	3,33	

BLISTERS

CÓDIGO CODE CODE	MEDIDA SIZE MESURE	Blister	Caja	CINCADO	
				PRECIO TARIFA PRICE LIST PRIX TARIFS	€/BLISTER
BAZGT05	19x70 / Ø5x25	6	20	2,09	
BAZGT06	20x80 / Ø6x30	6	20	2,09	
BAZGT08	21x100 / Ø8x40	4	20	2,09	

PEDIDO MÍNIMO 1 EMBALAJE / MINIMUM ORDER 1 PACKAGING
COMMANDE MINIMALE 1 EMBALLAGE / MINDESTBESTELLMENGE 1 VERPACKUNG

PASADOR DIN94 CINCADO

ZINC PLATED SPLIT PINS DIN 94
GOUPILLE DIN 94 EN ACIER ZINGUÉ
SPLINTE DIN 94 VERZINKT

ZN

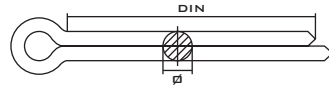

CAJA

CINCADO

COD.: 94Z

PRECIO TARIFA / PRICE LIST / PRIX TARIFS **€/100 u.**

m.m.	∅1	∅1,6	∅2	∅2,5	∅3,2	∅3,5	∅4	∅4,5	∅5	∅6,3	∅7	∅8	∅10
10	1,67	1,77	1,90										
12	1,70	1,84	1,97	*2,21									
16	1,77	1,87	2,04	2,24	2,24		*4,07						
18	1,84	1,98	2,15										
20	1,87	2,00	2,17	2,33	2,47	3,31	4,10		*6,72				
25	2,01	2,10	2,27	2,47	2,53	3,90	4,70	6,72	6,87	9,54			
28			*2,80	*3,02	*3,29		*5,56						
32		2,64	2,08	3,02	3,30	4,70	5,60		10,44	11,47	17,14		
36		2,81	3,00	3,24	3,48	5,00	5,85		10,90	12,07	17,97		
40			3,37	3,59	3,90	5,57	6,45	8,10	11,70	13,34	19,60	26,84	45,94
50			4,10	4,37	4,64	6,70	7,70	9,30	13,37	15,94	22,84	32,14	54,47
56					5,07	7,17	8,47		14,14	17,20	24,14	32,14	58,77
63					5,90	8,37	9,60	11,90	15,67	19,77	27,74	38,20	67,20
71					8,97	8,57	10,80		16,40	21,00	29,37	41,04	72,20
80						10,42	12,90		17,87	23,47	30,90	46,00	81,64
90									19,40	25,77	34,68	50,80	91,20
100										28,37	39,38	54,70	100,94
125												63,64	131,24
140												72,27	141,67
160													163,04

*HASTA AGOTAR EXISTENCIAS

MALETÍN PASADORES DIN 94 CINCADOS

ZINC PLATED SPLIT PINS DIN 94 BRIEFCASE / MALLETTE DE GOUPILLE DIN 94 EN ACIER ZINGUÉ / HANDKOFFER AUS SPLINTE DIN 94 VERZINKT



MEASURES INCLUDED IN THE BRIEFCASE / MESURES INCLUSES DANS LE MALLETTE

MEDIDA SIZE / MESURE m.m.	CANTIDAD QUANTITY QUANTITÉ	MEDIDA SIZE / MESURE m.m.	CANTIDAD QUANTITY QUANTITÉ
1,6x16	50	4,5x25	25
2x32	50	4,5x40	25
2x50	50	5x40	25
2,5x16	50	5x63	25
3,2x16	50	6,3x45	12
3,2x25	25	8x50	12
3,2x56	25	8x90	12
4x25	25	10x90	5
4x40	25		

CÓDIGO
CODE / CODE

DESCRIPCIÓN
DESCRIPTION / DESCRIPTION

M94Z

MALETÍN DE PASADORES DIN 94 CINCADOS

PRECIO TARIFA / PRICE LIST

PRECIO TARIFA / PRICE LIST

€/UNIDAD

€/100 u.

51,57

5.157,00

PASADOR EN "R" CINCADO

ZINC PLATED SPRING COOTERS FOR BOLT
GOUPILE BETA EN ACIER ZINGUÉ
BETA-STIFT VERZINKT

ZN

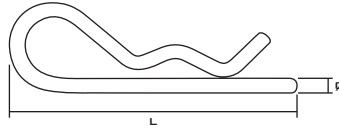

CAJA

CÓDIGO CODE CODE	MEDIDA SIZE MESURE	ØxL	Caja	CINCADO	
				PRECIO TARIFA PRICE LIST PRIX TARIFS	
				€/100 u.	
PRZ020050	2x50	2x51	200	10,32	
PRZ025050	2,5x50	2,5x51	200	12,61	
PRZ030070	3x70	3x61	200	15,44	
PRZ035070	3,5x70	3,5x67	100	19,85	
PRZ040085	4x85	4x76	100	29,78	
PRZ045085	4,5x85	4,5x83	100	37,47	
PRZ050105	5x105	5x100	100	56,07	
PRZ060105	6x105	6x114	100	87,89	
PRZ070120	7x120	7x120	50	135,95	
PRZ080155	8x155	8x140	25	-	
PRZ100175	10x175	10x175	25	656,49	

AUTOSERVICIO

CÓDIGO CODE CODE	MEDIDA SIZE MESURE	CINCADO		PRECIO TARIFA PRICE LIST PRIX TARIFS
		€/BOLSA		
		Nº		
BFPRZ20050	2x50	50	12	9,58
BFPRZ25050	2,5x50	40	12	10,67
BFPRZ30070	3x70	25	12	11,48
BFPRZ35070	3,5x70	20	12	14,28
BFPRZ40085	4x85	15	12	16,22
BFPRZ45085	4,5x85	10	12	12,32
BFPRZ50105	5x105	8	12	19,78
BFPRZ60105	6x105	5	12	14,77

BLISTERS

CÓDIGO CODE CODE	MEDIDA SIZE MESURE	CINCADO		PRECIO TARIFA PRICE LIST PRIX TARIFS
		€/BLISTER		
		Nº		
BPRZ020050	2x50	6	12	2,89
BPRZ025050	2,5x50	6	12	2,89
BPRZ030070	3x70	6	12	2,89
BPRZ035070	3,5x70	6	12	2,89
BPRZ040085	4x85	6	12	2,89
BPRZ045085	4,5x85	4	12	2,89
BPRZ050105	5x105	4	12	2,89
BPRZ060105	6x105	2	12	2,89

**PEDIDO MÍNIMO 1 EMBALAJE / MINIMUM ORDER 1 PACKAGING
COMMANDE MINIMALE 1 EMBALLAGE / MINDESTBESTELLMENGE 1 VERPACKUNG**

MALETÍN PASADORES EN "R" CINCADOS

ZINC PLATED SPRING COOTERS FOR BOLT BRIEFCASE / MALLETTE AVEC TROUSSE DE GOUPILE BETA EN ACIER ZINGUÉ
HANDKOFFER AUS BETA-STIFT VERZINKT



MEDIDAS INCLUIDAS EN EL MALETÍN
MEASURES INCLUDED IN THE BRIEFCASE / MESURES INCLUSES DANS LE MALLETTE

MEDIDA SIZE / MESURE m.m.	CANTIDAD QUANTITY QUANTITÉ	MEDIDA SIZE / MESURE m.m.	CANTIDAD QUANTITY QUANTITÉ
2x51	12	5x100	4
2,5x51	12	6x114	4
3x61	10	7x120	4
3,5x67	10	8x140	2
4x76	10	10x175	2
4,5x83	7		

CÓDIGO CODE / CODE	DESCRIPCIÓN DESCRIPTION / DESCRIPTION
MPR2	MALETÍN DE PASADORES "R" CINCADOS

PRECIO TARIFA / PRICE LIST	PRECIO TARIFA / PRICE LIST
€/UNIDAD	€/100 u.
51,57	5.157,00

PASADOR ANILLA CINCADO

ZINC PLATED LINC PINS
GOUPILLE ANNEUX EN ACIER ZINGUÉ
KLAPPSTECKER VERZINKT

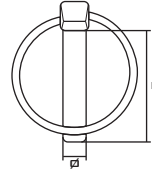

ZN

CAJA

CÓDIGO CODE CODE	MEDIDA SIZE MESURE	CINCO	CINCADO	
			PRECIO TARIFA PRICE LIST PRIX TARIFS	€/100 u.
	ø x L (m.m.)			
PAZ04532	4,5x32	100		47,63
PAZ06040	6x40	100		59,55
PAZ07040	7x40	100		63,75
PAZ08045	8x45	100		67,00
PAZ09045	9x45	100		82,25
PAZ10045	10x45	100		95,25
PAZ11045	11x45	50		99,91

AUTOSERVICIO

CÓDIGO CODE CODE	MEDIDA SIZE MESURE	CINCO		CINCADO	
		PRECIO TARIFA PRICE LIST PRIX TARIFS	PRECIO TARIFA PRICE LIST PRIX TARIFS	€/BOLSA	€/BOLSA
	m.m.				
BFPAZ4532	4,5x32	10	12		7,91
BFPAZ6040	6x40	8	12		7,88
BFPAZ7040	7x40	6	12		6,47
BFPAZ8045	8x45	6	12		6,75

BLISTERS

CÓDIGO CODE CODE	MEDIDA SIZE MESURE	CINCO		CINCADO	
		PRECIO TARIFA PRICE LIST PRIX TARIFS	PRECIO TARIFA PRICE LIST PRIX TARIFS	€/BLISTER	€/BLISTER
	m.m.				
BPAZ045032	4,5x32	4	12		3,89
BPAZ060040	6x40	4	12		3,89
BPAZ070040	7x40	4	12		3,89
BPAZ080045	8x45	4	12		3,89
BPAZ090045	9x45	2	12		3,89
BPAZ100045	10x45	2	12		3,89
BPAZ110045	11x45	2	12		3,89

**PEDIDO MÍNIMO 1 EMBALAJE / MINIMUM ORDER 1 PACKAGING
COMMANDE MINIMALE 1 EMBALLAGE / MINDESTBESTELLMENGE 1 VERPACKUNG**

MALETÍN PASADORES ANILLA CINCADOS

ZINC PLATED LINC PINS BRIEFCASE / MALLETTE DE GOUPILLE ANNEAUX EN ACIER ZINGUÉ / HANDKOFFER AUS KLAPPSTECKER VERZINKT



MEDIDAS INCLUIDAS EN EL MALETÍN
MEASURES INCLUDED IN THE BRIEFCASE / MESURES INCLUSES DANS LE MALLETTE

MEDIDA SIZE / MESURE m.m.	CANTIDAD QUANTITY QUANTITÉ
ø 4,5x32	10
ø 6x40	8
ø 7x40	8
ø 8x45	8
ø 9x45	8
ø 10x45	5
ø 11x45	5

CÓDIGO CODE / CODE	DESCRIPCIÓN DESCRIPTION / DESCRIPTION
MPAZ2	MALETÍN DE PASADORES ANILLA CINCADOS

PRECIO TARIFA / PRICE LIST	PRECIO TARIFA / PRICE LIST
€/UNIDAD	€/100 u.
51,57	5.157,00

PASADOR EN "R" DOBLE VUELTA CINCADO

ZINC PLATED SPRING COOTERS DOUBLE LOOP FOR BOLT
GOUPILLE BETA TORDU EN ACIER ZINGUÉ
BETA-STIFT DOPPEL-LOOP VERZINKT



ZN

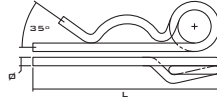

CAJA

CINCADO

CÓDIGO CODE CODE	MEDIDA SIZE MEASURE	CAJA	PRECIO TARIFA PRICE LIST PRIX TARIFS
	∅xL (m.m.)		€/100 u.
PRD02060	2x60	100	12,38
PRD03070	3x70	100	23,18
PRD04090	4x93	50	45,20
PRD05110	5x108	50	88,56
PRD06140	6x120	40	252,10

PASADOR ANILLA CENTRO EJE - MEDIA LUNA

ZINC PLATED PIPE LINCH PINS
GOUPILLE POUR TUBES EN ACIER ZINGUÉ
ROHRKLAPPSTECKER

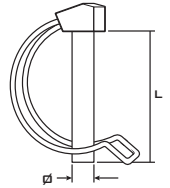

ZN

CAJA

CINCADO

CÓDIGO CODE CODE	MEDIDA SIZE MEASURE	CAJA	PRECIO TARIFA PRICE LIST PRIX TARIFS
	∅xL (m.m.)		€/100 u.
PAC06040	6x40	50	92,82
PAC07050	7x50	50	110,49
PAC08050	8x50	50	118,95
PAC10050	10x50	25	158,61

GANCHO EN "S" CINCADO

ZINC PLATED "S" HOOK
CROCHETS "S" EN ACIER ZINGUÉ
"S" HAKEN VERZINKT

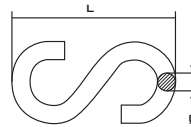

ZN

AUTOSERVICIO

CINCADO

CÓDIGO CODE CODE	MEDIDA SIZE MEASURE	CAJA	PRECIO TARIFA PRICE LIST PRIX TARIFS
	m.m.		€/BOLSA
BFSEZ2020	2x20	100 12	10,89
BFSEZ2525	2,5x25	75 12	9,31
BFSEZ3030	3x30	50 12	7,63
BFSEZ4040	4x40	35 12	9,87
BFSEZ5060	5x60	12 12	7,73
BFSEZ6070	6x70	8 12	15,73

CAJA

CINCADO

CÓDIGO CODE CODE	MEDIDA SIZE MEASURE	CAJA	PRECIO TARIFA PRICE LIST PRIX TARIFS
	∅xL (m.m.)		€/100 u.
ESEZ2020	2x20	500	9,10
ESEZ2525	2,5x25	500	11,00
ESEZ3030	3x30	500	15,17
ESEZ4040	4x40	200	25,00
ESEZ4550	4,5x50	150	36,00
ESEZ5060	5x60	100	48,00
ESEZ6070	6x70	75	85,60

**PEDIDO MÍNIMO 1 EMBALAJE
MINIMUM ORDER 1 PACKAGING**

HEMBRILLA CERRADA ROSCA MÉTRICA CINCADA

EYE THREAD ZINC PLATED
PITON VIS À OEILLET EN ACIER ZINGUÉ
VERZINKTE AUGENSCHRAUBE

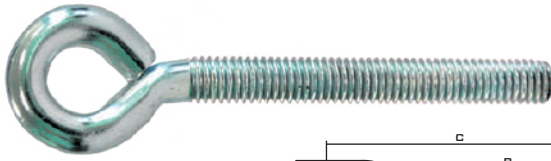

ZN

CAJA

CÓDIGO CODE CODE	(MxB)	A	C	PRECIO TARIFA PRICE LIST PRIX TARIFS	CINCADO	
					PRECIO TARIFA PRICE LIST PRIX TARIFS	PRECIO TARIFA PRICE LIST PRIX TARIFS
	m.m.	m.m.	m.m.	€100 u.		
HC04030	4x30	17	54	200	15,03	
HC05040	5x37	21	65	200	21,90	
HC06050	6x50	25	80	150	34,88	
HC08065	8x60	30	95	100	61,25	
HC10075	10x70	37	113	50	111,55	
HC12085	12x85	43	135	50	184,97	

HEMBRILLA ABIERTA ROSCA MÉTRICA CINCADA

HOOK THREAD ZINC PLATED
PITON VIS À OEILLET OUVERT EN ACIER ZINGUÉ
VERZINKTE RUNDHAKEN

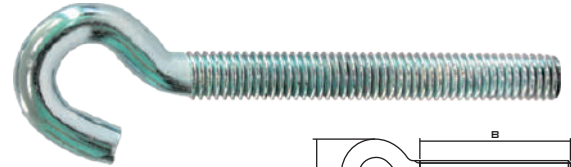

ZN

CAJA

CÓDIGO CODE CODE	(MxB)	A	C	PRECIO TARIFA PRICE LIST PRIX TARIFS	CINCADO	
					PRECIO TARIFA PRICE LIST PRIX TARIFS	PRECIO TARIFA PRICE LIST PRIX TARIFS
	m.m.	m.m.	m.m.	€100 u.		
HA04030	4x30	17	54	200	15,03	
HA05040	5x37	21	65	200	21,90	
HA06050	6x50	25	80	150	34,88	
HA08065	8x60	30	95	100	61,25	
HA10075	10x70	37	113	50	111,55	
HA12085	12x85	47	145	50	184,97	

HEMBRILLA CERRADA ESTAMPADA CINCADA

FORGED EYE THREAD ZINC PLATED
PITON VIS À OEILLET FORGÉ EN ACIER ZINGUÉ
VERZINKTE GEPRESST-AUGENSCHRAUBE



ZN

CAJA

CÓDIGO CODE CODE	(MxL)	B	G	F	PRECIO TARIFA PRICE LIST PRIX TARIFS	CINCADO	
						PRECIO TARIFA PRICE LIST PRIX TARIFS	PRECIO TARIFA PRICE LIST PRIX TARIFS
	m.m.	m.m.	m.m.	m.m.	€100 u.		
HCE06050	6x50	55	19	10	150	63,41	
HCE08065	8x60	65	22,5	11,8	100	90,63	
HCE10081	10x73	81	27	14,5	50	128,13	
HCE12098	12x90	98	33,5	17	50	246,88	

HEMBRILLA ABIERTA ESTAMPADA CINCADA

FORGED HOOK THREAD ZINC PLATED
PITON VIS À OEILLET OUVERT FORGÉ EN ACIER ZINGUÉ
VERZINKTE GEPRESST-RUNDHAKEN



ZN

CAJA

CÓDIGO CODE CODE	(MxL)	A	E	H	PRECIO TARIFA PRICE LIST PRIX TARIFS	CINCADO	
						PRECIO TARIFA PRICE LIST PRIX TARIFS	PRECIO TARIFA PRICE LIST PRIX TARIFS
	m.m.	m.m.	m.m.	m.m.	€100 u.		
HAE06050	6x50	77	22,5	8	150	63,41	
HAE08065	8x60	98	30	10	100	90,63	
HAE10081	10x73	116,5	36	12,5	50	128,13	
HAE12098	12x90	146	47	16	50	246,88	

HEMBRILLA CERRADA INOXIDABLE A-2

FORGED EYE THREAD STAINLESS STEEL AISI 304
PITON VIS À OEILLET FORGÉ EN ACIER INOX. A-2
GEPRESST-AUGENSCHRAUBE - EDELSTAHL A-2



**INOX
A2**

CAJA

CÓDIGO CODE CODE	(MxL)	B	G	F	PRECIO TARIFA PRICE LIST PRIX TARIFS	INOX. A-2	
						PRECIO TARIFA PRICE LIST PRIX TARIFS	PRECIO TARIFA PRICE LIST PRIX TARIFS
	m.m.	m.m.	m.m.	m.m.	€100 u.		
HCA206050	6x55	60	20	10	150	295,47	
HCA208070	8x60	65	22	11	100	460,25	
HCA210076	10x73	81	31	14	50	642,07	
HCA212094	12x90	97,5	35	16	50	1.093,75	

HEMBRILLA ABIERTA INOXIDABLE A-2

FORGED HOOK THREAD STAINLESS STEEL AISI 304
PITON VIS À OEILLET OUVERT FORGÉ EN ACIER INOX. A-2
VERZINKTE GEPRESST-RUNDHAKEN - EDELSTAHL A-2



**INOX
A2**

CAJA

CÓDIGO CODE CODE	(MxL)	A	E	H	PRECIO TARIFA PRICE LIST PRIX TARIFS	INOX. A-2	
						PRECIO TARIFA PRICE LIST PRIX TARIFS	PRECIO TARIFA PRICE LIST PRIX TARIFS
	m.m.	m.m.	m.m.	m.m.	€100 u.		
HAA206050	6x55	82	22,5	8	150	295,47	
HAA208070	8x60	98	30	10	100	460,25	
HAA210076	10x73	116,5	36	12,5	50	642,07	
HAA212090	12x90	146	47	16	50	1.093,75	

TORNILLO DIN 912 8.8 CINCADO

CYLINDER HEAD HEXAGONAL RECESS SCREW DIN 912 8.8 - ZINC PLATED
VIS FILETAGE MÉTRIQUE TÊTE CYLINDRIQUE À SIX PANS CREUX DIN 912 8.8 - ZINGUÉ
ZYLINDERSCHRAUBE MIT INNENSECHSKANT DIN 912 8.8 - VERZINKT

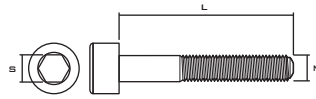

CAJA

CINCADO

COD.: 9128Z

PRECIO TARIFA / PRICE LIST / PRIX TARIFS **€/100 u.**

m.m.	M4 (S-3)	M5 (S-4)	M6 (S-5)	M8 (S-6)	M10 (S-8)	M12 (S-10)	M14 (S-12)	M16 (S-14)	M20 (S-17)
8	4,44	6,47							
10	3,91	4,85	5,97	14,88					
12	3,88	4,85	8,60						
16	4,29	4,80	5,88	11,60	22,35				
20	4,72	5,22	7,44	12,57	23,47	37,85			
25	5,29	6,07	8,35	13,82	25,75	36,00			
30	6,32	6,82	9,10	15,04	27,79	38,69			
35	7,69	7,94	10,41	17,94	29,72	40,97			
40	8,57	9,04	11,60	19,13	31,82	43,32	75,13	84,82	
45		11,47	12,69	20,63	35,07	46,60	78,10	93,29	
50		12,63	13,79	21,91	36,86	50,07	110,38	96,41	177,66
60		15,30	17,44	26,60	41,60	57,97	110,38	111,04	195,00
65				29,79	46,54	63,29	119,29	124,91	205,91
70				30,19	48,75	69,35	119,29	127,00	231,13
80				37,75	56,32	80,32	129,35	135,50	261,32
90				45,13	74,82	90,94	147,22	149,66	285,25
100				54,13	79,97	107,10	170,91	166,41	292,13
110					97,50	145,50	203,00	241,69	371,25
120					102,04	161,79	203,00	246,85	356,25
130					132,04	183,50	222,04	296,66	387,50
140					149,38	197,88		345,97	449,10
150					167,66	218,66			473,38
160						242,57			515,79
170									528,97
180									640,67
190									650,00
200									872,16

TORNILLO DIN 7991 10.9 CINCADO

HEXAGON SOCKET COUNTERSUNK HEAD SCREW 10.9 ZINC PLATED
VIS FILETAGE MÉTRIQUE DIN 7991 10.9 EN ACIER ZINGUÉ
SENKKOPFSCHRAUBE MIT INNENSECHSKANT DIN 7991 10.9 - VERZINKT

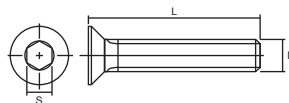

CAJA

CINCADO

COD.: 79911Z

PRECIO TARIFA / PRICE LIST / PRIX TARIFS **€/100 u.**

m.m.	M4 (S-2,5)	M5 (S-3)	M6 (S-4)	M8 (S-5)	M10 (S-6)	M12 (S-8)
10	5,65	6,07	7,54			
12	5,65	5,80	7,57			
16	5,65	5,94	7,20	13,07		
20	5,72	6,17	8,40	14,10	27,13	
25	6,54	6,94	9,57	15,67	29,25	49,27
30	7,16	7,90	10,60	17,60	31,97	46,10
35		9,72	12,00	20,94	34,54	51,43
40		12,97	13,44	22,40	37,30	54,94
45			14,67	24,27	42,19	61,22
50			17,60	25,94	45,82	67,57
60			29,14	29,80	61,25	77,50
70				40,63	64,69	121,41
80				50,97	92,35	125,00
90				101,94	120,16	166,16
100				144,85	180,51	198,00

TORNILLO DIN 912 8.8 CINCADO TX

CYLINDER HEAD 6-LOBE RECESS SCREW DIN 912 8.8 - ZINC PLATED
VIS FILETAGE MÉTRIQUE TÊTE CYLINDRIQUE TX DIN 912 8.8 EN ACIER ZINGUÉ
ZYLINDERSCHRAUBE MIT INNENSECHSRUND DIN 912 8.8 - VERZINKT

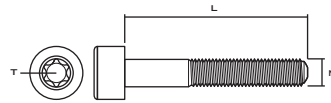
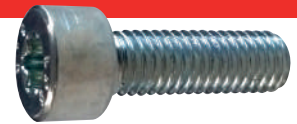

CAJA

CINCADO

COD.: 912BTZ

PRECIO TARIFA / PRICE LIST / PRIX TARIFS **€/100 u.**

m.m.	M6 (T-30)	MB (T-45)
16	34,08	
20	34,08	48,91
25		54,32
30		76,72

TORNILLO DIN 7991 8.8 TX CINCADO

COUNTERSUNK HEAD 6-LOBE RECESS SCREW DIN 7991 8.8 - ZINC PLATED
VIS FILETAGE MÉTRIQUE TÊTE FRAISÉE TX DIN 7991 8.8 EN ACIER ZINGUÉ
SENKOPFSCHRAUBE MIT INNENSECHSRUND DIN 7991 8.8 - VERZINKT

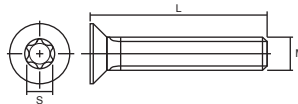

CAJA

CINCADO

COD.: 7991BTZ

PRECIO TARIFA / PRICE LIST / PRIX TARIFS **€/100 u.**

m.m.	M5 (T-25)	M6 (T-30)	MB (T-40)
10	11,79	13,07	
16	13,10	13,50	23,75
20	13,72	15,63	24,25
25	15,82	16,07	30,32
30		23,32	32,41

TORNILLO CON VALONA DIN 6921 8.8 GRAFILADO CINCADO

HEXAGONAL FLANGED WASHER HEAD WITH SERRATION SCREW DIN 6921 8.8 ZINC PLATED
VIS TÊTE HEXAGONALE DIN 6921 8.8 EN ACIER ZINGUÉ
SECHSKANTSCHRAUBE MIT GERÄNDELTER UNTEREGSCHEIBE DIN 6921 8.8 VERZINKT

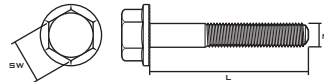

CAJA

CINCADO

COD.: 6921Z

PRECIO TARIFA / PRICE LIST / PRIX TARIFS **€/100 u.**

m.m.	M6 (SW-10)	MB (SW-13)	M10 (SW-15)	M12 (SW-16)
10	9,38			
16	9,69	18,10		
20	10,13	19,63		
25	11,55	21,16	32,94	52,39
30	14,66	23,00	39,91	59,22
35			47,01	67,44
40			49,35	74,93
50				83,97

TORNILLO ISO 7380 CINCADO

HEXAGON SOCKET PANHEAD SCREW ISO 7380 ZINC PLATED
VIS FILETAGE MÉTRIQUE TÊTE BOMBÉE À SIX PANS CREUX ISO 7380
EN ACIER ZINGUÉ / RUNDKOPFSCHRAUBE MIT INNENSECHSKANT ISO 7380 - VERZINKT

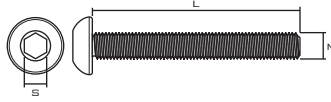

CAJA

CINCADO

COD.: 7380Z

PRECIO TARIFA / PRICE LIST / PRIX TARIFS €100 u.

m.m.	M4 (S-2,5)	M5 (S-3)	M6 (S-4)	M8 (S-5)	M10 (S-6)
8	6,50	7,34			
10	6,57	5,67	8,30	18,05	
12	6,88	7,00	8,60	15,89	
16	7,85	7,47	7,60	17,68	33,46
20	8,00	8,04	9,69	19,60	28,75
25		8,82	10,22	22,73	40,26
30			12,63	26,30	33,29
35				28,47	38,10
40				34,94	44,55
45				46,90	
50					55,66
60					66,32

TORNILLO ISO 7380 CINCADO TX

6-LOBE RECESS PANHEAD SCREW ISO 7380 ZINC PLATED
VIS FILETAGE MÉTRIQUE TÊTE BOMBÉE TX ISO 7380 EN ACIER ZINGUÉ
RUNDKOPFSCHRAUBE MIT INNENSECHSRUND ISO 7380 - VERZINKT

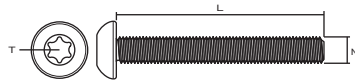
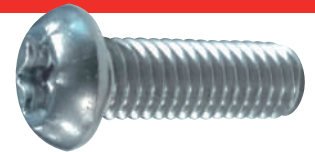

CAJA

CINCADO

COD.: 7380TZ

PRECIO TARIFA / PRICE LIST / PRIX TARIFS €100 u.

m.m.	M5 (T-25)	M6 (T-30)	M8 (T-40)
10	24,57		
16	28,47	31,50	46,10
20	29,97	32,19	41,22
25	31,57	33,75	44,69
30			60,60

TORNILLO CON VALONA ISO 7380-2 CINCADO

HEXAGON SOCKET PANHEAD WITH WASHER SCREW ISO 7380-2 ZINC PLATED
VIS FILETAGE MÉTRIQUE TÊTE BOMBÉE AVEC RONDELLE À SIX PANS CREUX ISO 7380-2 EN ACIER ZINGUÉ
RUNDKOPFSCHRAUBE MIT SCHEIBEN UND INNENSECHSKANT ISO 7380-2 - VERZINKT

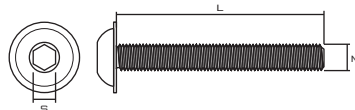

CAJA

CINCADO

COD.: 7380AZ

PRECIO TARIFA / PRICE LIST / PRIX TARIFS €100 u.

m.m.	M5 (S-3)	M6 (S-4)	M8 (S-5)
10	12,66	12,19	
16	14,35	13,72	28,35
20	17,16	16,22	30,75
25	18,35	18,66	34,35
30		20,91	38,91

TORNILLO DIN 603 + TUERCA DIN 934 CINCADO

MUSHROOM HEAD SQUARE NECK BOLT DIN 603 WITH NUT DIN 934 - ZINC PLATED
BOULON TÊTE BOMBÉE TIGE À COLLET CARRÉ DIN 603 AVEC ECROU DIN 934 EN ACIER ZINGUÉ
FLACHHRUNDKOPF-BOLZENSCHAFT MIT VIERKANT DIN 603 UND MUTTER DIN 934 - VERZINKT

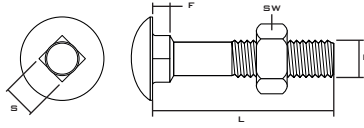

CAJA

CINCADO

COD.: 6034Z

PRECIO TARIFA / PRICE LIST / PRIX TARIFS €100 u.

m.m.	M5 (SW-8)	M6 (SW-10)	M7 (SW-11)	M8 (SW-13)	M10 (SW-17)	M12 (SW-19)
16	5,19	7,64		14,29		
20	5,47	8,29		15,54	26,47	
25	5,75	8,57		16,35	28,38	
30	6,13	8,94		17,32	29,79	48,25
35	6,50	9,54		18,38	32,04	50,88
40	6,88	10,16	23,53	19,35	33,63	54,72
45	7,90	11,04	24,32	20,54	35,44	56,66
50	9,57	11,54	25,10	21,94	37,22	59,38
60	10,69	13,19	26,15	24,50	41,79	65,00
70	11,93	17,17	29,69	26,69	45,32	70,79
80		19,00	32,50	29,44	48,54	80,00
90		20,67		33,88	53,29	81,27
100		22,63	37,55	33,88	56,57	87,41
120		28,00		38,72	77,13	116,13
130		33,00		54,90	82,00	127,80
140				58,40	86,97	133,77
150				62,00	91,93	140,40
160				62,83	102,00	157,20
170					106,73	164,10
180				80,47	111,63	170,47
190					116,47	176,93
200				80,86	132,50	197,30
220					144,03	220,07
240					154,64	240,27
260					172,20	264,07
280					175,48	266,97
300					186,17	275,33

INSTALACIÓN

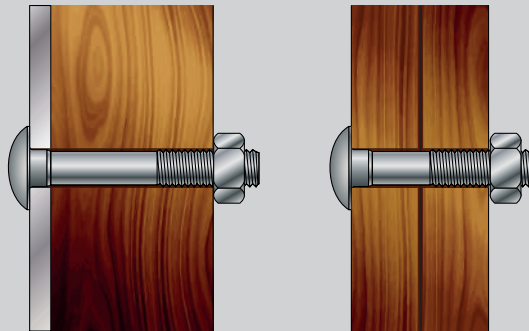

INFORMACIÓN TÉCNICA / TECHNICAL DATA

	S _{min}	F _{max}
M5	4,52	4,10
M6	5,52	4,60
M8	7,42	5,60
M10	9,42	6,60
M12	11,30	8,75

TORNILLO DIN 933 8.8 CINCADO

HEXAGONAL HEAD SCREW DIN 933 8.8 GRADE - ZINC PLATED
VIS TÊTE HEXAGONALE DIN 933 CLASSE 8.8 EN ACIER ZINGUÉ
SECHSKANTSCHRAUBE DIN 933 KLASSE 8.8 - VERZINKT

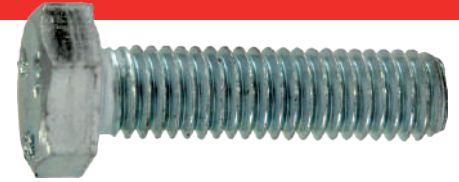
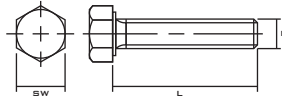

CAJA

CINCADO

COD.: 9338Z

PRECIO TARIFA / PRICE LIST / PRIX TARIFS **€/100 u.**

m.m.	M4 (SW-7)	M5 (SW-8)	M6 (SW-10)	M8 (SW-13)	M10 (SW-17)	M12 (SW-19)	M14 (SW-22)	M16 (SW-24)	M18 (SW-27)	M20 (SW-30)
10	2,73	3,72	3,75	7,60						
12	2,80	3,38								
16	3,25	3,88	4,10	8,32						
20	3,75	4,44	4,88	9,63	16,50	25,07				
25	4,38	5,16	5,32	10,44	17,94	26,60				
30	4,82	5,63	6,41	11,66	19,69	29,16	51,63			
35	5,90	6,41	6,75	12,85	21,57	31,54	56,04	62,85		118,75
40	5,94	7,04	7,66	14,07	23,47	34,07	60,50	67,88	117,66	120,88
45			8,10	15,25	25,44	36,50	64,85	76,10	125,57	127,88
50			8,88	16,38	27,22	39,16	69,41	77,54	133,35	134,75
55			11,57	25,44	30,44		73,79	82,79	135,07	139,16
60			10,04	18,72	31,25	43,41	78,19	90,22	150,07	146,10
65			12,75	27,29	36,32	52,10	82,69	102,04	157,88	152,82
70			15,22	25,22	34,85	55,07	87,25	107,79	165,79	163,32
80			17,94	27,32	42,57	56,25	95,32	119,41	182,38	175,72
90			19,91	32,85	51,00	75,94	104,19	130,22	198,04	229,75
100			22,57	37,66	51,00	85,32	113,07	143,07	213,82	248,50

AUTOSERVICIO

CINCADO

BLISTERS

CINCADO

CÓDIGO CODE CODE	MEDIDA SIZE MEASURE			PRECIO TARIFA PRICE LIST PRIX TARIFS
	MxL (m.m.)			€/BOLSA
BF933Z06016	6x16	50	12	3,41
BF933Z06020	6x20	50	12	3,88
BF933Z06025	6x25	45	12	3,82
BF933Z06030	6x30	40	12	3,91
BF933Z06040	6x40	30	12	3,69
BF933Z06050	6x50	20	12	3,58
BF933Z06060	6x60	15	12	2,64
BF933Z08016	8x16	40	12	5,60
BF933Z08020	8x20	35	12	5,44
BF933Z08025	8x25	30	12	5,29
BF933Z08030	8x30	25	12	5,07
BF933Z08040	8x40	20	12	4,04
BF933Z08050	8x50	15	12	3,85
BF933Z08060	8x60	15	12	4,63
BF933Z08070	8x70	10	12	4,59
BF933Z08080	8x80	10	12	4,69
BF933Z10020	10x20	15	12	4,04
BF933Z10025	10x25	15	12	4,38
BF933Z10030	10x30	15	12	5,16
BF933Z10035	10x35	15	12	5,32
BF933Z10040	10x40	10	12	3,79
BF933Z10050	10x50	10	12	5,12
BF933Z10060	10x60	10	12	5,50
BF933Z10070	10x70	6	12	3,88
BF933Z10080	10x80	4	12	3,59
BF933Z10090	10x90	2	12	2,51
BF933Z10100	10x100	2	12	2,68
BF933Z12030	12x30	10	12	4,63
BF933Z12040	12x40	8	12	4,54
BF933Z12050	12x50	6	12	3,94

CÓDIGO CODE CODE	MEDIDA SIZE MEASURE			PRECIO TARIFA PRICE LIST PRIX TARIFS
	MxL (m.m.)			€/BLISTER
B933Z06016	3x10	10	20	1,60
B933Z06020	3x16	10	20	1,60
B933Z06025	3x20	10	20	1,60
B933Z06030	4x16	6	20	1,60
B933Z06040	4x20	6	20	1,60
B933Z06050	4x25	6	20	1,60
B933Z06060	4x30	6	20	1,60
B933Z08016	4x40	6	20	1,60
B933Z08020	5x10	6	20	1,60
B933Z08025	5x16	6	20	1,60
B933Z08030	5x20	6	20	1,60
B933Z08040	5x25	6	20	1,60
B933Z08050	5x30	6	20	1,60
B933Z08060	5x40	6	20	1,60
B933Z08070	5x50	6	20	1,60
B933Z08080	6x10	6	20	1,60
B933Z10020	6x16	6	20	1,60
B933Z10025	6x20	6	20	1,60
B933Z10030	6x25	6	20	1,60
B933Z10035	6x30	6	20	1,60
B933Z10040	6x40	6	20	1,60
B933Z10050	6x50	6	20	1,60
B933Z10060	6x60	4	20	1,60
B933Z10070	8x16	4	20	1,60
B933Z10080	8x20	4	20	1,60
B933Z10090	8x25	4	20	1,60
B933Z10100	8x30	4	20	1,60
B933Z12030	8x40	4	20	1,60
B933Z12040	8x50	4	20	1,60
B933Z12050	8x60	4	20	1,60

**PEDIDO MÍNIMO 1 EMBALAJE / MINIMUM ORDER 1 PACKAGING
COMMANDE MINIMALE 1 EMBALLAGE / MINDESTBESTELLMENGE 1 VERPACKUNG**

MALETÍN TORNILLOS DIN 933 CINCADOS

ZINC PLATED HEXAGONAL HEAD SCREW DIN 933 BRIEFCASE
MALLETTE AVEC VIS TÊTE HEXAGONALE DIN 933 EN ACIER ZINGUÉ
HANDKOFFER AUS SECHSKANTSCHRAUBE DIN 933 VERZINKT



MEASURES INCLUDED IN THE BRIEFCASE / MESURES INCLUSES DANS LE MALLETTE

MEDIDA SIZE / MESURE m.m.	CANTIDAD QUANTITY QUANTITÉ	MEDIDA SIZE / MESURE m.m.	CANTIDAD QUANTITY QUANTITÉ
M-4x16	50	M-8x25	15
M-4x20	30	M-8x30	10
M-4x25	25	M-8x40	8
M-5x16	40	M-8x60	6
M-5x20	30	M-8x80	5
M-5x25	25	M-10x20	8
M-6x16	30	M-10x30	6
M-6x20	30	M-10x40	5
M-6x25	25	M-10x70	4
M-6x30	20	M-10x100	2
M-8x20	15		

CÓDIGO
CODE / CODE

DESCRIPCIÓN
DESCRIPTION / DESCRIPTION

M933Z

MALETÍN TORNILLO DIN 933 CINCADO

PRECIO TARIFA / PRICE LIST

PRECIO TARIFA / PRICE LIST

€/UNIDAD
51,57

€/100 u.
5.157,00

TORNILLO DIN 931 8.8 CINCADO

HEXAGONAL HEAD SCREW DIN 931 8.8 GRADE - ZINC PLATED
VIS TÊTE HEXAGONALE DIN 931 CLASSE 8.8 EN ACIER ZINGUÉ
SECHSKANTSCHRAUBE DIN 931 KLASSE 8.8 - VERZINKT

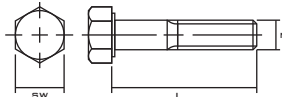

CAJA

CINCADO

COD.: 931BZ

PRECIO TARIFA / PRICE LIST / PRIX TARIFS €/100 u.

m.m.	M6 (SW-10)	M8 (SW-13)	M10 (SW-17)	M12 (SW-19)	M14 (SW-22)	M16 (SW-24)	M18 (SW-27)	M18 (SW-27)
35	8,63							
40	9,22	16,80	27,94	45,44				
45	10,69	17,69	31,82	45,44				
50	11,63	19,32	32,82	45,44	76,47			
55	12,69	20,60	34,97	48,94	82,10	102,19		
60	13,63	22,19	37,44	52,38	87,72	96,19		
65	16,47	23,79	39,91	54,97	109,00	102,47		
70	18,75	25,38	42,38	58,41	97,85	108,72		180,69
80	21,60	28,50	49,72	65,38	103,82	121,25	226,41	199,47
90	23,47	43,13	54,69	72,25	118,29	133,75	249,10	214,58
100	26,75	48,19	62,04	78,19	129,50	159,07	271,66	237,04
110		52,41	74,63	105,16	140,69	175,25	275,00	304,69
120		55,44	80,00	113,88	152,75	189,10	325,32	327,04
130		59,19	85,66	121,94	178,91	199,50	429,82	348,38
140			91,04	131,07	190,25	203,25	458,82	370,79
150				138,75	201,50	227,29	487,94	393,25

TORNILLO DIN 84 CINCADO

SCREW DIN 84 ZINC PLATED
VIS FILETAGE MÉTRIQUE DIN 84 EN ACIER ZINGUÉ
ZYLINDERKOPFSCHRAUBE DIN 84 VERZINKT

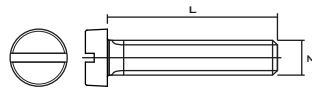

CAJA

CINCADO

COD.: 84Z

PRECIO TARIFA / PRICE LIST / PRIX TARIFS **€/100 u.**

m.m.	M3	M4	M5	M6	M8
6	1,36	2,00			
8	1,36	2,12			
10	1,45	2,21	3,19	5,04	11,94
12	1,57	2,35	3,38	5,32	13,74
16	1,75	2,72	3,97	5,75	11,25
20	1,94	2,95	4,47	6,44	15,66
25	2,12	3,32	4,94	7,32	16,25
30	2,71	3,69	5,57	8,19	16,88
35		4,07	6,10	9,45	17,50
40		4,47	7,60	10,32	18,75
45		7,04	10,00	11,57	20,79
50		8,57	11,20	12,60	26,47
60		15,37	14,60	14,75	31,17

AUTOSERVICIO

CINCADO

CÓDIGO CODE CODE	MEDIDA SIZE MEASURE			PRECIO TARIFA PRICE LIST PRIX TARIFS
	MxL (m.m.)			€/BOLSA
BF84Z306	3x6	200	12	3,83
BF84Z310	3x10	200	12	3,97
BF84Z408	4x8	100	12	2,79
BF84Z410	4x10	100	12	3,28
BF84Z416	4x16	100	12	3,57
BF84Z420	4x20	100	12	4,08
BF84Z425	4x25	100	12	4,72
BF84Z430	4x30	100	12	5,51
BF84Z510	5x10	70	12	3,47
BF84Z516	5x16	70	12	4,05
BF84Z520	5x20	70	12	4,25
BF84Z525	5x25	50	12	3,71
BF84Z530	5x30	50	12	4,14
BF84Z540	5x40	50	12	4,72
BF84Z610	6x10	100	12	7,44
BF84Z616	6x16	100	12	6,24
BF84Z620	6x20	100	12	7,10
BF84Z625	6x25	75	12	7,56
BF84Z630	6x30	75	12	9,22
BF84Z640	6x40	50	12	4,81
BF84Z650	6x50	50	12	9,09

BLISTERS

CINCADO

CÓDIGO CODE CODE	MEDIDA SIZE MEASURE			PRECIO TARIFA PRICE LIST PRIX TARIFS
	MxL (m.m.)			€/BLISTER
BB4Z310	3x10	10	20	1,60
BB4Z316	3x16	10	20	1,60
BB4Z320	3x20	10	20	1,60
BB4Z410	4x10	6	20	1,60
BB4Z416	4x16	6	20	1,60
BB4Z420	4x20	6	20	1,60
BB4Z425	4x25	6	20	1,60
BB4Z510	5x10	6	20	1,60
BB4Z516	5x16	6	20	1,60
BB4Z520	5x20	6	20	1,60
BB4Z525	5x25	6	20	1,60
BB4Z530	5x30	6	20	1,60
BB4Z540	5x40	6	20	1,60
BB4Z610	6x10	6	20	1,60
BB4Z616	6x16	6	20	1,60
BB4Z620	6x20	6	20	1,60
BB4Z625	6x25	6	20	1,60
BB4Z630	6x30	6	20	1,60
BB4Z640	6x40	6	20	1,60
BB4Z650	6x50	6	20	1,60

**PEDIDO MÍNIMO 1 EMBALAJE / MINIMUM ORDER 1 PACKAGING
COMMANDE MINIMALE 1 EMBALLAGE / MINDESTBESTELLMENGE 1 VERPACKUNG**

TORNILLO DIN 7985 CINCADO

SCREW DIN 7985 ZINC PLATED
VIS FILETAGE MÉTRIQUE DIN 7985 EN ACIER ZINGUÉ
ZYLINDERKOPFSCHRAUBE DIN 7985 VERZINKT

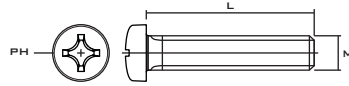

CAJA

CINCADO

COD.: 7985Z

PRECIO TARIFA / PRICE LIST / PRIX TARIFS **€/100 u.**

m.m.	M3 (PH-1)	M4 (PH-2)	M5 (PH-2)	M6 (PH-3)
6	1,45	2,12		
8	1,57	2,12	3,38	
10	1,71	2,26	3,69	5,72
12	1,71	2,53	3,97	6,00
16	2,07	2,81	4,47	6,79
20	2,17	3,09	4,85	7,32
25	2,44	3,47	5,54	8,19
30	2,76	3,97	6,10	9,13
35			6,79	9,57
40			7,57	10,82
45				11,90
50				12,98

AUTOSERVICIO

CINCADO

CÓDIGO CODE CODE	MEDIDA SIZE MEASURE			PRECIO TARIFA PRICE LIST PRIX TARIFS
	MxL (m.m.)			€/BOLSA
BF7985Z310	3x10	150	12	2,77
BF7985Z406	4x6	100	12	2,72
BF7985Z410	4x10	100	12	3,16
BF7985Z416	4x16	100	12	3,78
BF7985Z420	4x20	100	12	3,91
BF7985Z510	5x10	100	12	4,50
BF7985Z516	5x16	100	12	5,23
BF7985Z520	5x20	100	12	5,58
BF7985Z525	5x25	100	12	7,01
BF7985Z530	5x30	100	12	7,43
BF7985Z610	6x10	100	12	6,76
BF7985Z616	6x16	100	12	7,16
BF7985Z620	6x20	100	12	8,08
BF7985Z625	6x25	75	12	6,29
BF7985Z630	6x30	75	12	7,90
BF7985Z640	6x40	50	12	6,52
BF7985Z650	6x50	50	12	6,89

BLISTERS

CINCADO

CÓDIGO CODE CODE	MEDIDA SIZE MEASURE			PRECIO TARIFA PRICE LIST PRIX TARIFS
	MxL (m.m.)			€/BLISTER
B7985Z310	3x10	10	20	1,60
B7985Z316	3x16	10	20	1,60
B7985Z320	3x20	10	20	1,60
B7985Z410	4x10	6	20	1,60
B7985Z416	4x16	6	20	1,60
B7985Z420	4x20	6	20	1,60
B7985Z425	4x25	6	20	1,60
B7985Z430	4x30	6	20	1,60
B7985Z440	4x40	6	20	1,60
B7985Z510	5x10	6	20	1,60
B7985Z516	5x16	6	20	1,60
B7985Z520	5x20	6	20	1,60
B7985Z525	5x25	6	20	1,60
B7985Z530	5x30	6	20	1,60
B7985Z540	5x40	6	20	1,60
B7985Z610	6x10	6	20	1,60
B7985Z616	6x16	6	20	1,60
B7985Z620	6x20	6	20	1,60
B7985Z625	6x25	6	20	1,60
B7985Z630	6x30	6	20	1,60
B7985Z640	6x40	6	20	1,60

PEDIDO MÍNIMO 1 EMBALAJE / MINIMUM ORDER 1 PACKAGING
COMMANDE MINIMALE 1 EMBALLAGE / MINDESTBESTELLMENGE 1 VERPACKUNG

TORNILLO DIN 965 CINCADO

SCREW DIN 965 ZINC PLATED
VIS FILETAGE MÉTRIQUE DIN 965 EN ACIER ZINGUÉ
ZYLINDERKOPFSCHRAUBE DIN 965 VERZINKT

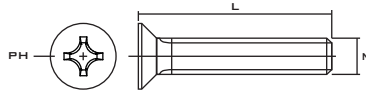

CAJA

CINCADO

COD.: 965Z

PRECIO TARIFA / PRICE LIST / PRIX TARIFS **€/100 u.**

m.m.	M3 (PH-1)	M4 (PH-2)	M5 (PH-2)	M6 (PH-3)
6	1,17			
8	1,25	1,41		
10	1,50	1,64	2,80	3,47
12	1,50	1,83	2,80	3,72
16	1,75	2,12	3,31	4,47
20	1,85	2,40	3,88	5,10
25	2,48	2,85	4,41	6,00
30		3,20	4,88	6,88
35		3,91	5,82	7,82
40		5,50	6,60	8,72
50		7,63	9,10	10,41

AUTOSERVICIO

CINCADO

CÓDIGO CODE CODE	MEDIDA SIZE MEASURE			PRECIO TARIFA PRICE LIST PRIX TARIFS
	MxL (m.m.)			€/BOLSA
BF965Z306	3x6	200	12	3,73
BF965Z310	3x10	200	12	3,73
BF965Z408	4x8	100	12	2,72
BF965Z410	4x10	100	12	2,82
BF965Z416	4x16	100	12	3,10
BF965Z420	4x20	100	12	3,50
BF965Z425	4x25	100	12	3,85
BF965Z430	4x30	100	12	4,63
BF965Z510	5x10	70	12	3,00
BF965Z516	5x16	70	12	3,44
BF965Z520	5x20	70	12	3,82
BF965Z530	5x30	50	12	3,44
BF965Z540	5x40	50	12	4,35
BF965Z610	6x10	70	12	4,54
BF965Z616	6x16	70	12	4,88
BF965Z620	6x20	70	12	5,60
BF965Z630	6x30	50	12	4,94

BLISTERS

CINCADO

CÓDIGO CODE CODE	MEDIDA SIZE MEASURE			PRECIO TARIFA PRICE LIST PRIX TARIFS
	MxL (m.m.)			€/BLISTER
B965Z306	3x10	10	20	1,60
B965Z310	3x16	10	20	1,60
B965Z408	3x20	10	20	1,60
B965Z410	4x10	6	20	1,60
B965Z416	4x16	6	20	1,60
B965Z420	4x20	6	20	1,60
B965Z425	4x25	6	20	1,60
B965Z430	4x30	6	20	1,60
B965Z510	5x10	6	20	1,60
B965Z516	5x16	6	20	1,60
B965Z520	5x20	6	20	1,60
B965Z530	5x25	6	20	1,60
B965Z540	5x30	6	20	1,60
B965Z610	6x20	6	20	1,60
B965Z616	6x25	6	20	1,60
B965Z620	6x30	6	20	1,60
B965Z630	6x40	6	20	1,60

**PEDIDO MÍNIMO 1 EMBALAJE / MINIMUM ORDER 1 PACKAGING
COMMANDE MINIMALE 1 EMBALLAGE / MINDESTBESTELLMENGE 1 VERPACKUNG**

TORNILLO DIN 963 CINCADO + DIN 934 Y DIN 125

ZINC PLATED SCREW DIN 963 WITH NUT & WASHER
VIS FILETAGE MÉTRIQUE DIN 963 AVEC ÉCROU ET RONDELLE EN ACIER ZINGUÉ
SENKKOPFSCHRAUBE DIN 963 MIT MUTTER UND SCHEIBEN - VERZINKT

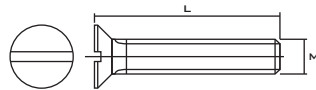

BLISTERS				CINCADO	
CÓDIGO CODE CODE	MEDIDA SIZE MESURE			PRECIO TARIFA PRICE LIST PRIX TARIFS	€/BLISTER
MxL (m.m.)					
BH963Z310	3x10	12	12	2,09	
BH963Z316	3x16	12	12	2,09	
BH963Z320	3x20	12	12	2,09	
BH963Z325	3x25	10	12	2,09	
BH963Z330	3x30	10	12	2,09	
BH963Z410	4x10	12	12	2,09	
BH963Z416	4x16	12	12	2,09	
BH963Z420	4x20	10	12	2,09	
BH963Z425	4x25	10	12	2,09	
BH963Z430	4x30	10	12	2,09	
BH963Z440	4x40	8	12	2,09	
BH963Z450	4x50	8	12	2,09	
BH963Z510	5x10	10	12	2,09	
BH963Z516	5x16	10	12	2,09	

BLISTERS				CINCADO	
CÓDIGO CODE CODE	MEDIDA SIZE MESURE			PRECIO TARIFA PRICE LIST PRIX TARIFS	€/BLISTER
MxL (m.m.)					
BH963Z520	5x20	10	12	2,09	
BH963Z525	5x25	10	12	2,09	
BH963Z530	5x30	8	12	2,09	
BH963Z540	5x40	8	12	2,09	
BH963Z610	6x10	10	12	2,09	
BH963Z616	6x16	10	12	2,09	
BH963Z620	6x20	10	12	2,09	
BH963Z625	6x25	10	12	2,09	
BH963Z630	6x30	10	12	2,09	
BH963Z640	6x40	10	12	2,09	
BH963Z650	6x50	8	12	2,09	
BH963Z660	6x60	8	12	2,89	
BH963Z670	6x70	6	12	2,89	
BH963Z680	6x80	6	12	2,89	

**PEDIDO MÍNIMO 1 EMBALAJE / MINIMUM ORDER 1 PACKAGING
COMMANDE MINIMALE 1 EMBALLAGE / MINDESTBESTELLMENGE 1 VERPACKUNG**

TORNILLO TIRADOR COMBI CINCADO

PZ COMBI RECESS PAN WASHER HEAD SCREW ZINC PLATED
VIS AVEC RONDELLE INTEGRÉE EMPREINTE PZ COMBI EN ACIER ZINGUÉ
LINSKOPFSCHRAUBE VERZINKT MIT KREUZSCHLITZ PZ COMBI

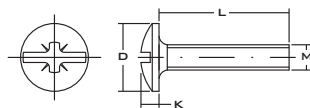
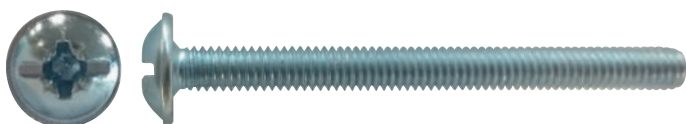

CAJA				CINCADO	
CÓDIGO CODE CODE	MEDIDA SIZE MESURE		PRECIO TARIFA PRICE LIST PRIX TARIFS	€/100 U.	
MxL (m.m.)					
TIRADOR412	4x12	1.000	2,41		
TIRADOR416	4x16	1.000	2,72		
TIRADOR420	4x20	1.000	2,81		
TIRADOR425	4x25	1.000	3,07		
TIRADOR430	4x30	1.000	4,04		
TIRADOR435	4x35	1.000	4,22		
TIRADOR440	4x40	1.000	5,38		
TIRADOR445	4x45	1.000	5,63		

TORNILLO TIRADOR CORTABLE COMBI CINCADO

PZ COMBI RECESS BRAKE-OFF PAN WASHER HEAD SCREW ZINC PLATED
VIS AVEC RONDELLE INTEGRÉE PZ COMBI EN ACIER ZINGUÉ
LINSKOPFSCHRAUBE VERZINKT UND KREUZSCHLITZ PZ COMBI

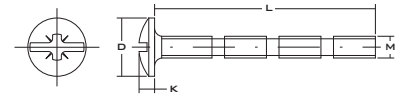



CAJA				CINCADO	
CÓDIGO CODE CODE	MEDIDA SIZE MESURE		PRECIO TARIFA PRICE LIST PRIX TARIFS	€/100 U.	
MxL (m.m.)					
TTC445	4x45	1.000	7,76		

TLLO. DIN 933 8.8 CINCADO + DIN 934 Y DIN 125

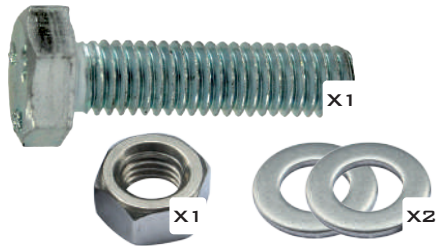
ZINC PLATED SCREW DIN 933 WITH NUT & WASHER
 VIS DIN 933 AVEC ÉCROU ET RONDELLE EN ACIER ZINGUÉ
 SECHSKANTSCHRAUBE DIN 933 MIT MUTTER UND SCHEIBEN - VERZINKT



BLISTERS

CÓDIGO CODE CODE	MEDIDA SIZE MESURE			CINCADO	
				PRECIO TARIFA PRICE LIST PRIX TARIFS	€/BLISTER
BH933Z03010	3x10	12	12		2,09
BH933Z03016	3x16	12	12		2,09
BH933Z03020	3x20	12	12		2,09
BH933Z04016	4x16	12	12		2,09
BH933Z04020	4x20	12	12		2,09
BH933Z04025	4x25	10	12		2,09
BH933Z05010	5x10	10	12		2,09
BH933Z05016	5x16	10	12		2,09
BH933Z05020	5x20	10	12		2,09
BH933Z05025	5x25	10	12		2,09
BH933Z05030	5x30	8	12		2,09
BH933Z05040	5x40	8	12		2,09
BH933Z06010	6x10	10	12		2,09
BH933Z06016	6x16	10	12		2,09
BH933Z06020	6x20	10	12		2,09
BH933Z06025	6x25	10	12		2,09
BH933Z06030	6x30	10	12		2,09
BH933Z06040	6x40	8	12		2,09
BH933Z06050	6x50	8	12		2,09
BH933Z06060	6x60	8	12		2,09
BH933Z06070	6x70	6	12		2,09
BH933Z08016	8x16	10	12		2,09
BH933Z08020	8x20	8	12		2,09
BH933Z08025	8x25	8	12		2,09
BH933Z08030	8x30	8	12		2,09
BH933Z08040	8x40	6	12		2,09
BH933Z08050	8x50	6	12		2,09
BH933Z08060	8x60	6	12		2,89
BH933Z08070	8x70	4	12		2,89
BH933Z08080	8x80	4	12		2,89
BH933Z10030	10x30	6	12		2,89
BH933Z10040	10x40	4	12		2,89
BH933Z10050	10x50	4	12		2,89
BH933Z10060	10x60	4	12		3,89
BH933Z10070	10x70	4	12		3,89
BH933Z10080	10x80	2	12		3,89
BH933Z10090	10x90	2	12		3,89
BH933Z10100	10x100	2	12		3,89

TLLO. DIN 84 CINCADO + DIN 934 Y DIN 125

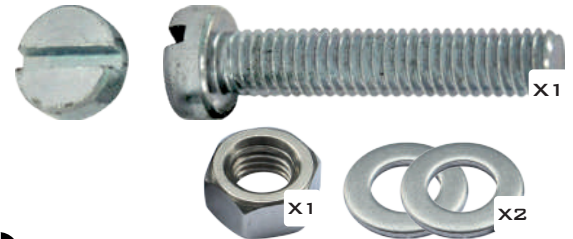
ZINC PLATED SCREW DIN 84 WITH NUT & WASHER
 VIS DIN 84 AVEC ÉCROU ET RONDELLE EN ACIER ZINGUÉ
 SECHSKANTSCHRAUBE DIN 84 MIT MUTTER UND SCHEIBEN



BLISTERS

CÓDIGO CODE CODE	MEDIDA SIZE MESURE			CINCADO	
				PRECIO TARIFA PRICE LIST PRIX TARIFS	€/BLISTER
BH84Z0310	3x10	12	12		2,09
BH84Z0316	3x16	12	12		2,09
BH84Z0320	3x20	12	12		2,09
BH84Z0325	3x25	10	12		2,09
BH84Z0330	3x30	10	12		2,09
BH84Z0340	3x40	8	12		2,09
BH84Z0410	4x10	12	12		2,09
BH84Z0416	4x16	12	12		2,09
BH84Z0420	4x20	10	12		2,09
BH84Z0425	4x25	10	12		2,09
BH84Z0430	4x30	10	12		2,09
BH84Z0440	4x40	8	12		2,09
BH84Z0510	5x10	10	12		2,09
BH84Z0516	5x16	10	12		2,09
BH84Z0520	5x20	10	12		2,09
BH84Z0525	5x25	10	12		2,09
BH84Z0530	5x30	8	12		2,09
BH84Z0540	5x40	8	12		2,09
BH84Z0610	6x10	10	12		2,09
BH84Z0616	6x16	10	12		2,09
BH84Z0620	6x20	10	12		2,09
BH84Z0625	6x25	10	12		2,09
BH84Z0630	6x30	10	12		2,09
BH84Z0640	6x40	8	12		2,09
BH84Z0650	6x50	8	12		2,09
BH84Z0660	6x60	8	12		2,89
BH84Z0670	6x70	6	12		2,89

PEDIDO MÍNIMO 1 EMBALAJE / MINIMUM ORDER 1 PACKAGING
 COMMANDE MINIMALE 1 EMBALLAGE / MINDESTBESTELLMENGE 1 VERPACKUNG

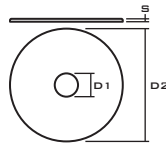
ARANDELA DE CARROCERO CINCADA

 ZINC PLATED WIDE WASHER
 RONDELLE DE CARROSSERIE EN ACIER ZINGUÉ
 KAROSSERIESCHEIBEN VERZINKT

ZN
CAJA
CINCADO







CÓDIGO CODE CODE	MEDIDA SIZE MEASURE (D1 x D2) m.m.	GROSOR THICKNESS ÉPAISSEUR (S) m.m.		PRECIO TARIFA
				PRICE LIST PRIX TARIFS €/100 u.
AEZ06420	6,4x20	1,5	200	10,67
AEZ06425	6,4x25	1,5	200	12,90
AEZ06430	6,4x30	1,5	200	17,20
AEZ08430	8,4x30	1,5	200	17,20
AEZ08435	8,4x35	1,5	200	21,32
AEZ08440	8,4x40	1,5	200	42,98
AEZ10535	10,5x35	1,5	200	21,32
AEZ10540	10,5x40	1,5	200	42,98
AEZ12540	12,5x40	1,5	200	42,98

VARILLAS ROSCADAS, TUERCAS Y ARANDELAS

 THREADED RODS, NUTS AND WASHERS
 TIGES FILETÉES, ÉCROUS ET RONDELLES
 GEWINDESTANGEN, MUTTERN UND SCHEIBEN

PV ZN
CAJA





 PRECIO TARIFA / PRICE LIST / PRIX TARIFS **€/100 u.**

	 DIN 934 B ZN Cod.: 934Z	 DIN 934 B PV Cod.: 934	 DIN 985 ZN Cod.: 985Z	 DIN 6923 ZN Cod.: 6923Z	 DIN 1587 ZN Cod.: 1587Z	 DIN 315 ZN Cod.: 315Z
M 3	0,59		1,97			11,21
M 4	0,97	1,13	1,64	2,06	5,32	11,21
M 5	1,09	1,20	1,64	2,50	5,47	11,69
M 6	1,61	1,88	2,11	3,47	6,41	14,03
M 8	3,16	3,57	4,07	6,79	12,50	19,15
M10	7,07	7,50	9,38	11,13	22,82	32,53
M12	10,47	11,75	13,13	16,69	34,63	63,01
M14	15,29	17,19	23,91	38,68	61,60	180,57
M16	20,47	23,44	28,38	45,66	62,72	199,82
M18	31,25	38,50	45,75			
M20	41,82	49,38	59,07			
M22	52,07	65,32	129,07			
M24	70,85	87,52	142,32			
M27	146,32	187,50	295,14			
M30	196,94	218,75	412,44			
M33	250,57		536,19			
M36	345,10		701,10			
M39	456,10		989,79			





VARILLAS ROSCADAS, TUERCAS Y ARANDELAS

 THREADED RODS, NUTS AND WASHERS
 TIGES FILETÉES, ÉCROUS ET RONDELLES
 GEWINDESTANGEN, MUTTERN UND SCHEIBEN

PV ZN
CAJA





		PRECIO TARIFA / PRICE LIST / PRIX TARIFS € / 100 U.				
						
MÉTRICA METRICS MÉTRIQUE		DIN 975 4.8 ZN Cod.: 975Z	DIN 975 8.8 ZN Cod.: 9758Z	DIN 125 ZN Cod.: 125Z	DIN 9021 ZN Cod.: 9021Z	DIN 127-B ZN Cod.: 127Z
M 3		67,47		0,63		
M 4		56,82		0,59	0,96	0,47
M 5		75,82		0,59	1,39	0,63
M 6		99,85	135,07	0,96	2,04	0,85
M 8		165,25	243,69	1,42	4,60	1,64
M10		253,69	358,41	2,92	9,00	2,66
M12		368,19	506,63	5,00	16,63	3,91
M14		512,47	695,72	7,04	24,07	6,75
M16		676,47	918,38	8,69	29,38	9,22
M18		840,44	1.140,88	12,07	53,16	10,75
M20		1.058,50	1.445,16	13,13	56,47	13,60
M22		1.551,82	1.838,04	16,50	141,27	25,16
M24		1.633,44	2.196,91	29,19	153,13	36,10
M27		2.128,13	2.880,57	39,97		50,00
M30		2.679,29	4.259,97	49,58		83,71
M33				88,44		126,54
M36				106,16		153,75
M39				141,50		

BLISTERS

		PRECIO TARIFA / PRICE LIST / PRIX TARIFS € / BLISTER				EMBALAJE / PACKAGING / EMBALLAGE X20			
									
MÉTRICA METRICS MÉTRIQUE		DIN 934 [8] ZN Cod.: B934Z	DIN 985 ZN Cod.: B985Z	DIN 125 ZN Cod.: B125Z	DIN 9021 ZN Cod.: B9021Z	DIN 127-B ZN Cod.: B127Z			
M 3		1,60	1,60	1,60	1,60	1,60			
M 4		1,60	1,60	1,60	1,60	1,60			
M 5		1,60	1,60	1,60	1,60	1,60			
M 6		1,60	1,60	1,60	1,60	1,60			
M 8		1,60	1,60	1,60	1,60	1,60			
M10		1,60	1,60	1,60	1,60	1,60			
M12		1,60	1,60	1,60	1,60	1,60			

PEDIDO MÍNIMO 1 EMBALAJE / MINIMUM ORDER 1 PACKAGING
 COMMANDE MINIMALE 1 EMBALLAGE / MINDESTBESTELLMENGE 1 VERPACKUNG

AUTOSERVICIO

		PRECIO TARIFA / PRICE LIST / PRIX TARIFS € / BOLSA				EMBALAJE / PACKAGING / EMBALLAGE X12			
									
MÉTRICA METRICS MÉTRIQUE		DIN 934 [8] ZN Cod.: BF934Z	DIN 985 ZN Cod.: BF985Z	DIN 125 ZN Cod.: BF125Z	DIN 9021 ZN Cod.: BF9021Z				
M 4		2,50	2,75	2,50	2,60				
M 5		2,88	2,75	2,25	2,88				
M 6		2,88	4,04	2,72	3,38				
M 8		4,13	3,41	3,13	3,79				
M10		3,66	3,82	5,79	4,16				
M12		3,88	3,66	6,79	3,75				

PEDIDO MÍNIMO 1 EMBALAJE / MINIMUM ORDER 1 PACKAGING
 COMMANDE MINIMALE 1 EMBALLAGE / MINDESTBESTELLMENGE 1 VERPACKUNG

MALETÍN DE TUERCAS CINCADAS

ZINC PLATED NUTS BRIEFCASE / MALLETTE DE ÉCROUS EN ACIER ZINGUÉ / HANDKOFFER AUS MUTTERN VERZINKT

 MEDIDAS INCLUIDAS EN EL MALETÍN
 MEASURES INCLUDED IN THE BRIEFCASE / MESURES INCLUSES DANS LE MALLETTE

DIN 934 ZN		DIN 985 ZN		DIN 6923 ZN	
MEDIDA SIZE / MESURE m.m.	CANTIDAD QUANTITY QUANTITÉ	MEDIDA SIZE / MESURE m.m.	CANTIDAD QUANTITY QUANTITÉ	MEDIDA SIZE / MESURE m.m.	CANTIDAD QUANTITY QUANTITÉ
M 3	100	M 4	100	M 6	50
M 4	100	M 5	100	M 8	25
M 5	100	M 6	50	M10	12
M 6	50	M 8	25	M12	5
M 8	25	M10	12		
M10	12	M12	7		
M12	7				
M14	5				
M16	5				
M20	5				



DIN 934

DIN 985

DIN 6923

CÓDIGO
 CODE / CODE

DESCRIPCIÓN
 DESCRIPTION / DESCRIPTION

MTU2

MALETÍN DE TUERCAS SURTIDAS CINCADAS

PRECIO TARIFA / PRICE LIST
PRECIO TARIFA / PRICE LIST
€/UNIDAD
€/100 u.

51,57

5.157,00

MALETÍN DE ARANDELAS CINCADAS

ZINC PLATED WASHERS BRIEFCASE / MALLETTE AVEC RONDELLES EN ACIER ZINGUÉ / HANDKOFFER AUS SCHEIBEN VERZINKT

 MEDIDAS INCLUIDAS EN EL MALETÍN
 MEASURES INCLUDED IN THE BRIEFCASE / MESURES INCLUSES DANS LE MALLETTE

DIN 125 ZN		DIN 9021 ZN		DIN 127 ZN	
MEDIDA SIZE / MESURE m.m.	CANTIDAD QUANTITY QUANTITÉ	MEDIDA SIZE / MESURE m.m.	CANTIDAD QUANTITY QUANTITÉ	MEDIDA SIZE / MESURE m.m.	CANTIDAD QUANTITY QUANTITÉ
M 4	100	M 4	100	M 4	100
M 5	100	M 5	100	M 5	100
M 6	100	M 6	50	M 6	100
M 8	50	M 8	25	M 8	50
M10	25	M10	12	M10	25
M12	12	M12	5	M12	12



DIN 125



DIN 9021

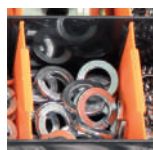

DIN 127



DIN 6798A

DIN 6798 ZN

MEDIDA SIZE / MESURE m.m.	CANTIDAD QUANTITY QUANTITÉ
M 6	100
M 8	50
M10	25

CÓDIGO
 CODE / CODE

DESCRIPCIÓN
 DESCRIPTION / DESCRIPTION

MAR2

MALETÍN DE ARANDELAS SURTIDAS CINCADAS

PRECIO TARIFA / PRICE LIST
PRECIO TARIFA / PRICE LIST
€/UNIDAD
€/100 u.

51,57

5.157,00

LLAVE / KEY / CLÉ - SW									
	DIN 934	DIN 985	DIN 6923	DIN 1587		DIN 934	DIN 985	DIN 6923	DIN 1587
M 3	5,5	5,5	5,5	5,5	M18	27	27	-	27
M 4	7	7	7	7	M20	30	30	30	30
M 5	8	8	8	8	M22	32	32	-	32
M 6	10	10	10	10	M24	36	36	36	36
M 8	13	13	13	13	M27	41	41	-	41
M10	17	17	15	17	M30	46	46	-	46
M12	19	19	18	19	M33	50	50	-	50
M14	22	22	21	22	M36	55	55	-	55
M16	24	24	24	24	M39	60	60	-	60

TORNILLO AUTOPERFORANTE DIN 7504-K CINCADO

HEX. FLAT WASHER HEAD SELF DRILLING SCREW WITH UNDERCUT DIN 7504-K ZINC PLATED
 VIS AUTOPERCEUSE TÊTE HEX. À RONDELLE INTÉGRÉE DIN 7504-K EN ACIER ZINGUÉ
 SECHSKANT-BOHRSCHRAUBE MIT INTEGRIERTER UNTERLEGSCHNEIBE DIN 7504-K VERZINKT

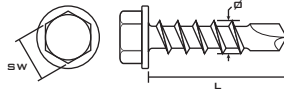
CAJA
CINCADO

COD.: 7504K

 PRECIO TARIFA / PRICE LIST / PRIX TARIFS **€/100 u.**

m.m.	∅3,5 (SW-5,5)	∅4,2 (SW-7)	∅4,8 (SW-8)	∅5,5 (SW-8)	∅6,3 (SW-10)
13	1,55	2,14	2,82		
16	1,83	2,32	3,08		
19	1,84	2,69	3,15	4,31	6,46
22				4,72	
25	2,29	3,05	3,72	4,97	7,11
32		3,36	4,34	5,79	8,35
38			4,82	6,41	9,07
50			6,47		12,38
63			8,16		15,54
75					16,68
80					21,76
90					22,56
100					25,21
120					35,63
130					40,63
140					42,94

AUTOSERVICIO
CINCADO

CÓDIGO CODE CODE	MEDIDA SIZE MESURE	200	12	PRECIO TARIFA PRICE LIST PRIX TARIFS
	∅xL (m.m.)			€/BOLSA
BF7504K35009	3,5x9,5	200	12	4,54
BF7504K35013	3,5x13	200	12	4,54
BF7504K42013	4,2x13	150	12	4,22
BF7504K42016	4,2x16	150	12	4,69
BF7504K42019	4,2x19	150	12	5,50
BF7504K42025	4,2x25	75	12	3,25
BF7504K42032	4,2x32	75	12	3,50
BF7504K48013	4,8x13	150	12	6,32
BF7504K48016	4,8x16	150	12	6,32
BF7504K48019	4,8x19	150	12	6,88
BF7504K48025	4,8x25	150	12	7,79
BF7504K48032	4,8x32	100	12	6,47
BF7504K48038	4,8x38	85	12	5,69
BF7504K55019	5,5x19	125	12	7,29
BF7504K55025	5,5x25	125	12	8,44
BF7504K55032	5,5x32	85	12	6,69
BF7504K55038	5,5x38	80	12	6,97
BF7504K55050	5,5x50	60	12	6,32
BF7504K55063	5,5x63	40	12	5,07
BF7504K63019	6,3x19	100	12	8,72
BF7504K63025	6,3x25	90	12	8,50
BF7504K63032	6,3x32	70	12	7,82
BF7504K63038	6,3x38	60	12	7,25
BF7504K63050	6,3x50	40	12	5,88
BF7504K63063	6,3x63	25	12	5,21

BLISTERS
CINCADO

CÓDIGO CODE CODE	MEDIDA SIZE MESURE	20	20	PRECIO TARIFA PRICE LIST PRIX TARIFS
	∅xL (m.m.)			€/BLISTER
B7504K35013	3,5x13	20	20	2,09
B7504K35016	3,5x16	20	20	2,09
B7504K35019	3,5x19	20	20	2,09
B7504K35025	3,5x25	20	20	2,09
B7504K42013	4,2x13	20	20	2,09
B7504K42016	4,2x16	20	20	2,09
B7504K42019	4,2x19	20	20	2,09
B7504K42025	4,2x25	10	20	2,09
B7504K42032	4,2x32	10	20	2,09
B7504K48013	4,8x13	10	20	2,09
B7504K48016	4,8x16	10	20	2,09
B7504K48019	4,8x19	10	20	2,09
B7504K48025	4,8x25	10	10	2,09
B7504K48032	4,8x32	10	10	2,09
B7504K48038	4,8x38	10	10	2,09
B7504K55019	5,5x19	10	10	2,09
B7504K55025	5,5x25	10	10	2,09
B7504K55032	5,5x32	10	10	2,09
B7504K55038	5,5x38	10	10	2,09
B7504K55050	5,5x50	10	10	2,09
B7504K63025	6,3x25	10	10	2,09
B7504K63032	6,3x32	10	10	2,09
B7504K63038	6,3x38	10	10	2,09
B7504K63050	6,3x50	5	10	2,09

**PEDIDO MÍNIMO 1 EMBALAJE / MINIMUM ORDER 1 PACKAGING
 COMMANDE MINIMALE 1 EMBALLAGE / MINDESTBESTELLMENGE 1 VERPACKUNG**



REF.: TEQ (PÁG. 105)



REF.: EPDM (PÁG. 103)



REF.: ANP (PÁG. 104)

TORNILLO AUTOPERFORANTE DIN 7504-K CINCADO + ARANDELA EPDM

HEX. HEAD SELF DRILLING SCREW DIN 7504-K ZINC PLATED WITH EPDM WASHER
VIS AUTOPERCEUSE TÊTE HEX. DIN 7504-K EN ACIER ZINGUÉ AVEC RONDELLE VULCANISÉ
SECHSKANT-BOHRSCHRAUBE DIN 7504-K VERZINKT MIT SCHEIBE EPDM

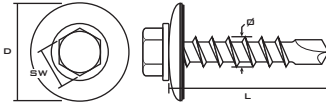

CAJA

CINCADO

COD.: 7504KA

PRECIO TARIFA / PRICE LIST / PRIX TARIFS € / 100 U.

TORNILLO SCREW / VIS	DIÁMETRO ARANDELA EPDM EPDM WASHER DIAMETER / DIAMÈTRE RONDELLE EPDM			
	Ø x L (m.m.)	Ø16	Ø18	Ø25
SW 8	4,8x16	6,16		
	4,8x19	6,04		
	4,8x22	8,35		
	4,8x25	7,00		
	4,8x32	9,11		
	4,8x38	9,88		
	4,8x50	13,07		
SW 8	5,5x22		8,07	11,91
	5,5x25		9,29	12,63
	5,5x32		10,00	15,37
	5,5x38		11,44	16,16
	5,5x50		14,16	18,23
SW 10	6,3x19		12,41	16,30
	6,3x25		12,44	17,33
	6,3x32		12,69	18,85
	6,3x38		17,13	20,36
	6,3x50		19,66	23,22

AUTOSERVICIO

CINCADO

CÓDIGO CODE CODE	MEDIDA SIZE MESURE			PRECIO TARIFA PRICE LIST PRIX TARIFS
	ØxL-D (m.m.)			€/BOLSA
BF7504KA481916	4,8x19-16	100	12	8,54
BF7504KA482516	4,8x25-16	80	12	7,57
BF7504KA552518	5,5x25-18	60	12	7,13
BF7504KA553218	5,5x32-18	50	12	7,42
BF7504KA553818	5,5x38-18	45	12	6,64
BF7504KA555018	5,5x50-18	35	12	5,54
BF7504KA632518	6,3x25-18	50	12	6,72
BF7504KA633218	6,3x32-18	50	12	8,69
BF7504KA633818	6,3x38-18	40	12	10,57

BLISTERS

CINCADO

CÓDIGO CODE CODE	MEDIDA SIZE MESURE			PRECIO TARIFA PRICE LIST PRIX TARIFS
	ØxL-D (m.m.)			€/BLISTER
B7504KA4801916	4,8x19-16	18	12	2,09
B7504KA4802516	4,8x25-16	18	12	2,09
B7504KA5502518	5,5x25-18	15	12	2,09
B7504KA5503218	5,5x32-18	12	12	2,09
B7504KA5503818	5,5x38-18	12	12	2,09
B7504KA5505018	5,5x50-18	10	12	2,09
B7504KA6302518	6,3x25-18	10	12	2,09
B7504KA6303218	6,3x32-18	8	12	2,09
B7504KA6303818	6,3x38-18	8	12	2,09

PEDIDO MÍNIMO 1 EMBALAJE / MINIMUM ORDER 1 PACKAGING
COMMANDE MINIMALE 1 EMBALLAGE / MINDESTBESTELLMENGE 1 VERPACKUNG

MALETÍN TORNILLOS DIN 7504-K CINCADOS

ZINC PLATED SCREW DIN 7504-K BRIEFCASE / MALLETTE VIS DIN 7504-K EN ACIER ZINGUÉ / HANDKOFFER BOHRSCHRAUBE DIN 7504-K VERZINKT



MEDIDAS INCLUIDAS EN EL MALETÍN
MEASURES INCLUDED IN THE BRIEFCASE / MESURES INCLUSES DANS LE MALLETTE

DIN 7504K				AR. EPDM	
MEDIDA SIZE / MESURE m.m.	CANTIDAD QUANTITY QUANTITÉ	MEDIDA SIZE / MESURE m.m.	CANTIDAD QUANTITY QUANTITÉ	MEDIDA SIZE / MESURE m.m.	CANTIDAD QUANTITY QUANTITÉ
3,5x13	100	4,8x25	50	Ø14	100
3,5x16	100	4,8x32	25	Ø16	100
3,5x19	100	4,8x38	25		
4,2x13	100	5,5x25	50		
4,2x16	100	5,5x32	25		
4,2x19	100	5,5x38	25		
4,2x25	50	6,3x25	25		
4,8x13	50	6,3x32	25		
4,8x16	50	6,3x38	15		
4,8x19	50				

CÓDIGO
CODE / CODE

DESCRIPCIÓN
DESCRIPTION / DESCRIPTION

M7504K MALETÍN TORNILLO DIN 7504-K CINCADO

PRECIO TARIFA / PRICE LIST

PRECIO TARIFA / PRICE LIST

€/UNIDAD € / 100 U.

61,88 6.188,00

NUEVO PRODUCTO / NEW PRODUCT / NOUVEAU PRODUIT

TORNILLO AUTOPERFORANTE DIN 7504-K PUNTA REDUCIDA CINCADO

ZINC PLATED SELF DRILLING SCREW WITH REDUCED POINT DIN 7504-K
VIS AUTOPERCEUSE AVEC POINTE RÉDUITE DIN 7504-K EN ACIER ZINGUÉ
SECHSKANT-BOHRSCRAUBE MIT REDUZIERTEM BOHRSPITZE DIN 7504-K VERZINKT

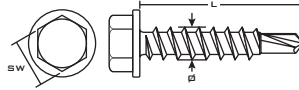

CAJA

CÓDIGO CODE CODE	MEDIDA SIZE MESURE ($\varnothing \times L$) m.m.	LLAVE KEY CLÉ SW	CAPACIDAD TALADRO DRILL CAPACITY CAPACITÉ DU PERCER m.m.	ESPESSOR A FIJAR THICKNESS TO FIX ÉPÀSSIEUR m.m.	CINCO	CINCADO	
						PRECIO TARIFA PRICE LIST PRIX TARIFS €/100 u.	
7504KR55022	5,5x22	8	1 - 1,5	11,5	500		7,16
7504KR63020	6,3x20	8	1 - 1,5	10	500		7,69
7504KR63025	6,3x25	8	1 - 1,5	13	500		9,07

NUEVO PRODUCTO / NEW PRODUCT / NOUVEAU PRODUIT

TLLLO. AUTOPERFORANTE DIN 7504-K PUNTA REDUCIDA CINCADO + EPDM Ø16

ZINC PLATED SELF DRILLING SCREW WITH REDUCED POINT DIN 7504-K + EPDM Ø16
VIS AUTOPERCEUSE AVEC POINTE RÉDUITE DIN 7504-K EN ACIER ZINGUÉ + EPDM Ø16
SECHSKANT-BOHRSCRAUBE MIT REDUZIERTEM BOHRSPITZE DIN 7504-K VERZINKT + EPDM Ø16

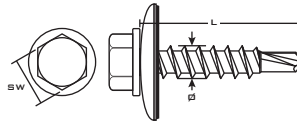

CAJA

CÓDIGO CODE CODE	MEDIDA SIZE MESURE ($\varnothing \times L - D$) m.m.	LLAVE KEY CLÉ SW	CAPACIDAD TALADRO DRILL CAPACITY CAPACITÉ DU PERCER m.m.	ESPESSOR A FIJAR THICKNESS TO FIX ÉPÀSSIEUR m.m.	CINCO	CINCADO	
						PRECIO TARIFA PRICE LIST PRIX TARIFS €/100 u.	
7504KRA55022	5,5x22 - 16	8	1 - 1,5	11,5	500		10,29
7504KRA63020	6,3x20 - 16	8	1 - 1,5	10	500		10,50
7504KRA63025	6,3x25 - 16	8	1 - 1,5	13	500		11,47

NUEVO PRODUCTO / NEW PRODUCT / NOUVEAU PRODUIT

TLLLO. DIN 7504-K BIMETAL PUNTA BROCA Nº3 - INOX. A2 / ACERO CARBONO

BIMETAL SELF DRILLING SCREW POINT 3
VIS AUTOPERCEUSE POINTE 3 BI-MÉTAL
BIMETALL SECHSKANT-BOHRSCRAUBE SPITZE 3



CÓDIGO CODE CODE	MEDIDA SIZE MESURE ($\varnothing \times L$) m.m.	LLAVE KEY CLÉ SW	CAPACIDAD TALADRO DRILL CAPACITY CAPACITÉ DU PERCER m.m.	ESPESSOR A FIJAR THICKNESS TO FIX ÉPÀSSIEUR m.m.	CINCO	SEIS	BIMETAL	
							PRECIO TARIFA PRICE LIST PRIX TARIFS €/100 u.	
7504KBI55026	5,5x26	8	2 - 8	8	200	2.000		99,44
7504KBI55030	5,5x30	8	2 - 8	12	200	2.000		107,82
7504KBI55040	5,5x40	8	2 - 8	22	200	2.000		117,94
7504KBI55050	5,5x50	8	2 - 8	32	200	2.000		141,88
7504KBI55070	5,5x70	8	2 - 8	52	100	1.000		166,22
7504KBI55090	5,5x90	8	2 - 8	72	100	1.000		221,47
7504KBI55110	5,5x110	8	2 - 8	92	100	1.000		254,19
7504KBI55130	5,5x130	8	2 - 8	112	100	1.000		282,75
7504KBI55150	5,5x150	8	2 - 8	132	100	1.000		424,97
7504KBI55180	5,5x180	8	2 - 8	162	100	1.000		565,88
7504KBI55200	5,5x200	8	2 - 8	182	100	1.000		634,38

INSTALACIÓN

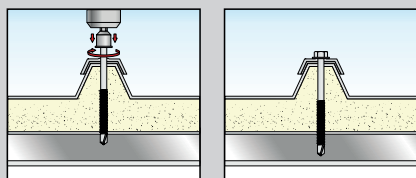

FIJACIÓN PARA TECHO EN SOPORTE DE ACERO SIN PERFORACIÓN.
LA CABEZA Y EL CUERPO DE ACERO INOXIDABLE ASEGURAN LA PROTECCIÓN MÁS ALTA CONTRA LA CORROSIÓN; ADEMÁS, EL ACABADO ESPECIAL DE PLATA GARANTIZA UNA PROTECCIÓN RESISTENTE DE LA PUNTA DE PERFORACIÓN DE ACERO AL CARBONO.

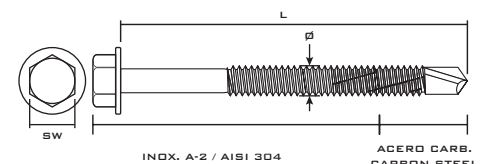

TORNILLO FSTZ AUTOPERFORANTE CABEZA PLANA CINCADO

SELF DRILLING SCREW FLAT PAN HEAD ZINC PLATED
VIS AUTOPERCEUSE TÊTE BOMBÉÉ PLATE EN ACIER ZINGUÉ
FLACHKOPF-BOHRSCHRAUBE KREUZSCHLITZ VERZINKT

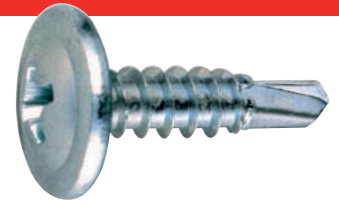
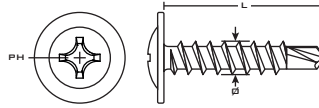
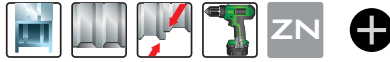

CAJA

CÓDIGO CODE CODE	MEDIDA SIZE MESURE (\varnothing xL) m.m.	LLAVE KEY CLÉ PH	CAPACIDAD TALADRO DRILL CAPACITY CAPACITÉ DU PERCER m.m.	ESPESOR A FIJAR THICKNESS TO FIX ÉPaisseur m.m.	CINCO	CINCADO
						PRECIO TARIFA PRICE LIST PRIX TARIFS €/100 u.
FSTZ4213	4,2x13	2	0,75-2,5	4	500	1,99
FSTZ4216	4,2x16	2	0,75-2,5	7	500	2,28
FSTZ4219	4,2x19	2	0,75-2,5	10	500	2,36
FSTZ4225	4,2x25	2	0,75-2,5	16	500	2,73

NUEVO PRODUCTO / NEW PRODUCT / NOUVEAU PRODUIT

TLL. AUTOPERFORANTE CABEZA EXTRAPLANA CINCADO

SELF DRILLING SCREW FLAT PAN HEAD ZINC PLATED
VIS AUTOPERCEUSE TÊTE BOMBÉÉ PLATE EN ACIER ZINGUÉ
FLACHKOPF-BOHRSCHRAUBE KREUZSCHLITZ VERZINKT

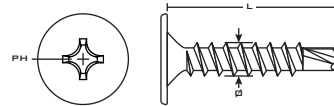
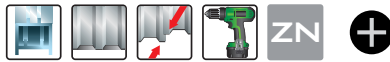

CAJA

CÓDIGO CODE CODE	MEDIDA SIZE MESURE (\varnothing xL) m.m.	LLAVE KEY CLÉ PH	CAPACIDAD TALADRO DRILL CAPACITY CAPACITÉ DU PERCER m.m.	ESPESOR A FIJAR THICKNESS TO FIX ÉPaisseur m.m.	CINCO	CINCADO
						PRECIO TARIFA PRICE LIST PRIX TARIFS €/100 u.
FSTP4214	4,2x14	2	2	6	500	2,03
FSTP4223	4,2x23	2	2	15	500	3,02

NUEVO PRODUCTO / NEW PRODUCT / NOUVEAU PRODUIT

TLL. AUTOPERFORANTE CABEZA EXTRAPLANA CINCADO NEGRO

SELF DRILLING SCREW FLAT PAN HEAD BLACK ZINC PLATED
VIS AUTOPERCEUSE TÊTE BOMBÉÉ PLATE EN ACIER ZINGUÉ NOIR
FLACHKOPF-BOHRSCHRAUBE KREUZSCHLITZ SCHWARZ VERZINKT

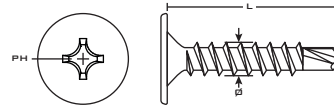
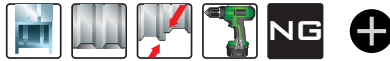

CAJA

CÓDIGO CODE CODE	MEDIDA SIZE MESURE (\varnothing xL) m.m.	LLAVE KEY CLÉ PH	CAPACIDAD TALADRO DRILL CAPACITY CAPACITÉ DU PERCER m.m.	ESPESOR A FIJAR THICKNESS TO FIX ÉPaisseur m.m.	CINCO	CINCADO NEGRO
						PRECIO TARIFA PRICE LIST PRIX TARIFS €/100 u.
FSTPN4214	4,2x14	2	2	6	500	3,02
FSTPN4223	4,2x23	2	2	15	500	4,50

NUEVO PRODUCTO / NEW PRODUCT / NOUVEAU PRODUIT

TLL. AUTOPERFORANTE CABEZA EXTRAPLANA LACADO BLANCO

SELF DRILLING SCREW FLAT PAN HEAD WHITE LACQUERED
VIS AUTOPERCEUSE TÊTE BOMBÉÉ PLATE EN ACIER LAQUÉ BLANC
FLACHKOPF-BOHRSCHRAUBE KREUZSCHLITZ SCHWARZ WEIß GESTRICHENEN

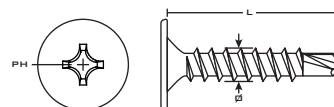

CAJA

CÓDIGO CODE CODE	MEDIDA SIZE MESURE (\varnothing xL) m.m.	LLAVE KEY CLÉ PH	CAPACIDAD TALADRO DRILL CAPACITY CAPACITÉ DU PERCER m.m.	ESPESOR A FIJAR THICKNESS TO FIX ÉPaisseur m.m.	CINCO	LACADO BLANCO
						PRECIO TARIFA PRICE LIST PRIX TARIFS €/100 u.
FSTPLB4214	4,2x14	2	2	6	500	4,79
FSTPLB4223	4,2x23	2	2	15	500	7,19

TORNILLO AUTOPERFORANTE DIN 7504-N CINCADO

PAN HEAD SELF DRILLING SCREW DIN 7504-N ZINC PLATED
VIS AUTOPERCEUSE TÊTE CYLINDRIQUE DIN 7504-N EN ACIER ZINGUÉ
ZYLINDERKOPF-BOHRSCRAUBE DIN 7504-N VERZINKT

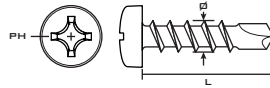
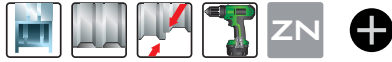
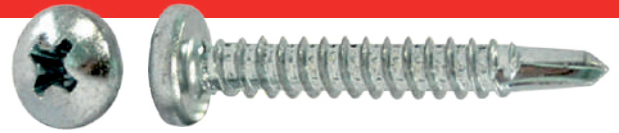

CAJA

CINCADO

COD.: 7504N

PRECIO TARIFA / PRICE LIST / PRIX TARIFS **€/100 u.**

m.m.	∅3,5 (PH-2)	∅3,9 (PH-2)	∅4,2 (PH-2)	∅4,8 (PH-2)	∅5,5 (PH-3)
9,5	1,07				
13	1,30			2,51	
16	1,38	1,79	1,89	2,61	
19	1,46	1,72	2,07	2,77	4,29
25	1,84	2,04	2,30	3,32	4,82
32		2,09	2,69	4,16	5,82
38		2,73	3,11	5,07	7,32
45			3,29	5,54	8,13
50				6,13	9,35

AUTOSERVICIO

CINCADO

CÓDIGO CODE CODE	MEDIDA SIZE MESURE	∅xL (m.m.)	PRECIO TARIFA PRICE LIST PRIX TARIFS	€/BOLSA
BF7504N35009	3,5x9,5	250 12	3,97	
BF7504N35013	3,5x13	250 12	4,32	
BF7504N35016	3,5x16	225 12	4,22	
BF7504N35019	3,5x19	225 12	4,47	
BF7504N35025	3,5x25	180 12	4,44	
BF7504N39013	3,9x13	250 12	6,46	
BF7504N39016	3,9x16	200 12	6,46	
BF7504N39019	3,9x19	200 12	4,88	
BF7504N39025	3,9x25	150 12	5,22	
BF7504N39032	3,9x32	150 12	7,25	
BF7504N42013	4,2x13	200 12	4,99	
BF7504N42016	4,2x16	200 12	4,85	
BF7504N42019	4,2x19	175 12	4,82	

AUTOSERVICIO

CINCADO

CÓDIGO CODE CODE	MEDIDA SIZE MESURE	∅xL (m.m.)	PRECIO TARIFA PRICE LIST PRIX TARIFS	€/BOLSA
BF7504N42025	4,2x25	125 12	4,07	
BF7504N42032	4,2x32	90 12	3,44	
BF7504N42038	4,2x38	75 12	3,38	
BF7504N42050	4,2x50	50 12	3,02	
BF7504N48013	4,8x13	125 12	4,00	
BF7504N48016	4,8x16	125 12	4,22	
BF7504N48019	4,8x19	100 12	4,07	
BF7504N48025	4,8x25	90 12	4,00	
BF7504N48032	4,8x32	75 12	3,91	
BF7504N48038	4,8x38	55 12	3,25	
BF7504N48045	4,8x45	50 12	3,84	
BF7504N48050	4,8x50	40 12	3,16	
BF7504N55032	5,5x32	50 12	6,22	

**PEDIDO MÍNIMO 1 EMBALAJE / MINIMUM ORDER 1 PACKAGING
COMMANDE MINIMALE 1 EMBALLAGE / MINDESTBESTELLMENGE 1 VERPACKUNG**

MALETÍN TORNILLOS DIN 7504-N CINCADOS

ZINC PLATED SCREW DIN 7504-N BRIEFCASE
MALLETTTE AVEC VIS DIN 7504-N EN ACIER ZINGUÉ
HANDKOFFER AUS BOHRSCRAUBE DIN 7504-N VERZINKT



MEDIDAS INCLUIDAS EN EL MALETÍN
MEASURES INCLUDED IN THE BRIEFCASE / MESURES INCLUSES DANS LE MALLETTTE

MEDIDA SIZE / MESURE m.m.	CANTIDAD QUANTITY QUANTITÉ	MEDIDA SIZE / MESURE m.m.	CANTIDAD QUANTITY QUANTITÉ
3,5x13	100	4,2x25	50
3,5x16	100	4,8x13	100
3,5x19	100	4,8x16	100
3,5x25	100	4,8x19	100
3,9x13	100	4,8x25	50
3,9x16	100	4,8x32	50
3,9x19	100	4,8x38	50
3,9x25	100	5,5x25	50
4,2x13	100	5,5x32	50
4,2x16	100	5,5x38	25
4,2x19	100		

CÓDIGO
CODE / CODE

DESCRIPCIÓN
DESCRIPTION / DESCRIPTION

M7504N

MALETÍN TORNILLO DIN 7504-N CINCADO

PRECIO TARIFA / PRICE LIST

PRECIO TARIFA / PRICE LIST

€/UNIDAD

€/100 u.

61,88

6.188,00

TORNILLO AUTOPERFORANTE DIN 7504-P CINCADO

FLAT CSK HEAD SELF DRILLING SCREW DIN 7504-P ZINC PLATED
VIS AUTOPERCEUSE TÊTE FRAISÉE PLATE DIN 7504-P EN ACIER ZINGUÉ
SENKKOPF-BOHRSCRAUBE DIN 7504-P VERZINKT

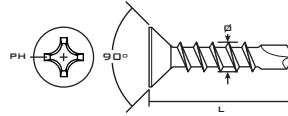
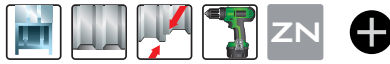

CAJA

CINCADO

COD.: 7504P

PRECIO TARIFA / PRICE LIST / PRIX TARIFS **€/100 u.**

m.m.	∅3,5 (PH-2)	∅3,9 (PH-2)	∅4,2 (PH-2)	∅4,8 (PH-2)	∅5,5 (PH-3)
13	1,27	1,38	1,53	2,16	
16	1,32	1,57	1,73	2,30	
19	1,57	1,73	1,88	2,91	3,51
25	1,78	1,95	2,35	2,76	3,98
32		2,35	2,72	3,68	4,91
38		2,75	3,21	4,30	7,57
45				5,79	

AUTOSERVICIO

CINCADO

CÓDIGO CODE CODE	MEDIDA SIZE MESURE			PRECIO TARIFA PRICE LIST PRIX TARIFS
	∅xL (m.m.)			€/BOLSA
BF7504P35013	3,5x13	250	12	4,04
BF7504P35016	3,5x16	225	12	4,04
BF7504P35019	3,5x19	200	12	4,19
BF7504P35025	3,5x25	180	12	4,35
BF7504P39013	3,9x13	200	12	3,72
BF7504P39016	3,9x16	200	12	4,10
BF7504P39019	3,9x19	175	12	4,07
BF7504P39025	3,9x25	150	12	3,97
BF7504P39038	3,9x38	100	12	3,72
BF7504P42013	4,2x13	175	12	3,60
BF7504P42016	4,2x16	175	12	4,07

AUTOSERVICIO

CINCADO

CÓDIGO CODE CODE	MEDIDA SIZE MESURE			PRECIO TARIFA PRICE LIST PRIX TARIFS
	∅xL (m.m.)			€/BOLSA
BF7504P42019	4,2x19	175	12	4,41
BF7504P42025	4,2x25	125	12	3,97
BF7504P42032	4,2x32	90	12	3,35
BF7504P42038	4,2x38	75	12	3,25
BF7504P48016	4,8x16	125	12	3,91
BF7504P48019	4,8x19	100	12	3,29
BF7504P48025	4,8x25	90	12	3,38
BF7504P48032	4,8x32	75	12	3,75
BF7504P48038	4,8x38	75	12	4,38
BF7504P55032	5,5x32	50	12	3,38

PEDIDO MÍNIMO 1 EMBALAJE / MINIMUM ORDER 1 PACKAGING
COMMANDE MINIMALE 1 EMBALLAGE / MINDESTBESTELLMENGE 1 VERPACKUNG

MALETÍN TORNILLOS DIN 7504-P CINCADOS

ZINC PLATED SCREW DIN 7504-P BRIEFCASE
MALLETTTE AVEC VIS DIN 7504-P EN ACIER ZINGUÉ
HANDKOFFER AUS BOHRSCRAUBE DIN 7504-P VERZINKT



MEDIDAS INCLUIDAS EN EL MALETÍN
MEASURES INCLUDED IN THE BRIEFCASE / MESURES INCLUSES DANS LE MALLETTTE

MEDIDA SIZE / MESURE m.m.	CANTIDAD QUANTITY QUANTITÉ	MEDIDA SIZE / MESURE m.m.	CANTIDAD QUANTITY QUANTITÉ
3,5x13	100	4,2x25	50
3,5x16	100	4,8x13	100
3,5x19	100	4,8x16	100
3,5x25	100	4,8x19	100
3,9x13	100	4,8x25	50
3,9x16	100	4,8x32	50
3,9x19	100	4,8x38	50
3,9x25	100	5,5x25	50
4,2x13	100	5,5x32	50
4,2x16	100	5,5x38	25
4,2x19	100		

CÓDIGO
CODE / CODE

DESCRIPCIÓN
DESCRIPTION / DESCRIPTION

M7504P

MALETÍN TORNILLO DIN 7504-P CINCADO

PRECIO TARIFA / PRICE LIST

PRECIO TARIFA / PRICE LIST

€/UNIDAD

€/100 u.

61,88

6.188,00

MALETÍN TORNILLOS DIN 7504-K, 7504-N Y 7504-P

 BRIEFCASE WITH SCREWS DIN 7504-K, 7504-N & 7504-P
 MALLETTE AVEC VIS DIN 7504-K, 7504-N ET 7504-P
 HANDKOFFER AUS BOHRSCHRAUBE DIN 7504-K, 7504-N UND 7504-P

MEDIDAS INCLUIDAS EN EL MALETÍN

MEASURES INCLUDED IN THE BRIEFCASE / MESURES INCLUSES DANS LE MALLETTE

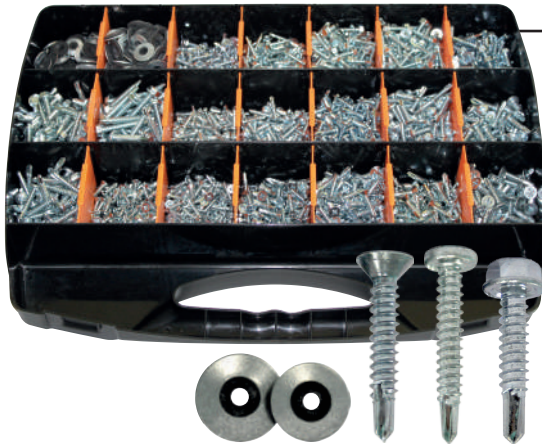

DIN 7504-K		DIN 7504-N		DIN 7504-P	
MEDIDA SIZE / MESURE m.m.	CANTIDAD QUANTITY QUANTITÉ	MEDIDA SIZE / MESURE m.m.	CANTIDAD QUANTITY QUANTITÉ	MEDIDA SIZE / MESURE m.m.	CANTIDAD QUANTITY QUANTITÉ
3,5x13	100	3,5x13	100	3,5x13	100
3,5x16	100	3,5x16	100	3,5x16	100
4,2x16	100	4,2x16	100	4,2x16	100
4,2x19	100	4,2x19	100	4,2x19	100
4,8x19	50	4,8x19	50	4,8x19	50
4,8x25	50	4,8x25	50	4,8x25	50
4,8x32	50				

ARANDELA EPDM

MEDIDA / SIZE / MESURE (m.m.)	CANTIDAD / QUANTITY / QUANTITÉ
Ø14	100
Ø16	100

CÓDIGO CODE / CODE	DESCRIPCIÓN DESCRIPTION / DESCRIPTION
M7504KPN	MALETÍN TLLD. DIN 7504-K, 7504-N Y 7504-P

PRECIO TARIFA / PRICE LIST	PRECIO TARIFA / PRICE LIST
€/UNIDAD	€/100 u.
61,88	6.188,00

MALETÍN TORNILLO DIN 7504-N CINCADO TX

 ZINC PLATED SCREWS DIN 7504-N TX BRIEFCASE
 MALLETTE AVEC VIS DIN 7504-N TX EN ACIER ZINGUÉ
 HANDKOFFER AUS BOHRSCHRAUBE DIN 7504-N TX VERZINKT

MEDIDA SIZE / MESURE m.m.	CANTIDAD QUANTITY QUANTITÉ	MEDIDA SIZE / MESURE m.m.	CANTIDAD QUANTITY QUANTITÉ
3,5x13	100	4,2x19	100
3,5x16	100	4,2x25	50
3,5x19	100	4,8x16	100
3,5x25	100	4,8x19	100
3,9x13	100	4,8x25	50
3,9x16	100	4,8x32	50
3,9x19	100	4,8x38	50
3,9x25	100	5,5x25	50
4,2x13	100	5,5x32	50
4,2x16	100	5,5x38	25

CÓDIGO CODE / CODE	DESCRIPCIÓN DESCRIPTION / DESCRIPTION
M7504NT	MALETÍN TORNILLO DIN 7504-N TX CINCADO

PRECIO TARIFA / PRICE LIST	PRECIO TARIFA / PRICE LIST
€/UNIDAD	€/100 u.
100,00	10.000,00

MALETÍN TORNILLO DIN 7504-P CINCADO TX

 ZINC PLATED SCREW DIN 7504-P TX BRIEFCASE
 MALLETTE AVEC VIS DIN 7504-P TX EN ACIER ZINGUÉ
 HANDKOFFER AUS BOHRSCHRAUBE DIN 7504-P TX VERZINKT



MEDIDA SIZE / MESURE m.m.	CANTIDAD QUANTITY QUANTITÉ	MEDIDA SIZE / MESURE m.m.	CANTIDAD QUANTITY QUANTITÉ
3,5x13	100	4,2x19	100
3,5x16	100	4,2x25	50
3,5x19	100	4,8x16	100
3,5x25	100	4,8x19	100
3,9x13	100	4,8x25	50
3,9x16	100	4,8x32	50
3,9x19	100	4,8x38	50
3,9x25	100	5,5x25	50
4,2x13	100	5,5x32	50
4,2x16	100	5,5x38	25

CÓDIGO CODE / CODE	DESCRIPCIÓN DESCRIPTION / DESCRIPTION
M7504PT	MALETÍN TORNILLO DIN 7504-P TX CINCADO

PRECIO TARIFA / PRICE LIST	PRECIO TARIFA / PRICE LIST
€/UNIDAD	€/100 u.
100,00	10.000,00

TORNILLO AUTOPERFORANTE DIN 7504-N CINCADO TX

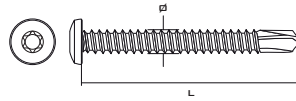
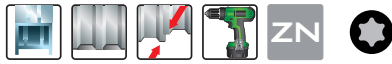
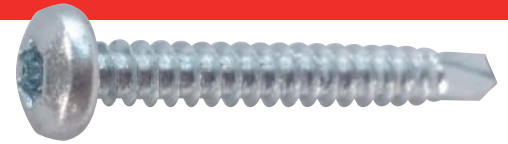
PAN HEAD 6-LOBE RECESS SELF DRILL. SCREW DIN 7504-N TX ZINC PLATED
VIS AUTOP. EMPREINTE À SIX LOBES DIN 7504-N TX EN ACIER ZINGUÉ
ZYLINDERKOPF-BOHRSCHRAUBE, EINSATZGEHÄRTET, DIN 7504-N TX VERZINKT



CAJA

CINCADO

COD.: 7504NT

PRECIO TARIFA / PRICE LIST / PRIX TARIFS **€/100 u.**

m.m.	Ø3,5 (T-15)	Ø3,9 (T-15)	Ø4,2 (T-20)	Ø4,8 (T-25)	Ø5,5 (T-25)	Ø6,3 (T-30)
9,5	3,29					
13	3,54	3,60	3,91			
16	3,91	3,97	4,22	5,75		
19	4,10	4,29	4,63	5,79	9,38	16,79
25	4,69	4,91	5,25	6,54	10,91	17,22
32	5,47	5,75	6,16	7,32	12,75	20,63
38		6,41		9,29	14,19	24,35
45				9,79	15,79	
50				11,97	17,32	27,38
60				15,16		32,19
70						37,50
80						45,25

TORNILLO AUTOPERFORANTE DIN 7504-P CINCADO TX

FLAT CSK. HEAD 6-LOBE RECESS SELF DRILLING SCREW DIN 7504-P TX ZINC PLATED
VIS AUTOP. EMPREINTE À SIX LOBES DIN 7504-P TX EN ACIER ZINGUÉ
SENKKOPF-BOHRSCHRAUBE INNENSECHSRUND, DIN 7504-P TX VERZINKT

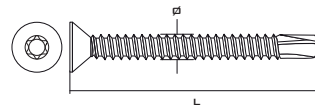
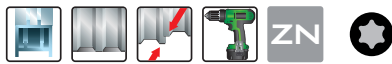
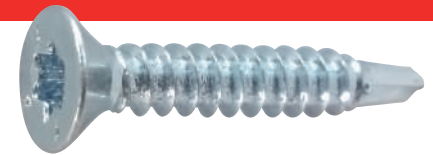

CAJA

CINCADO

COD.: 7504PT

PRECIO TARIFA / PRICE LIST / PRIX TARIFS **€/100 u.**

m.m.	Ø3,5 (T-15)	Ø3,9 (T-15)	Ø4,2 (T-20)	Ø4,8 (T-25)	Ø5,5 (T-25)	Ø6,3 (T-30)
13	3,19	3,13	3,63			
16	3,60	3,75	3,97	5,00		
19	3,91	4,04	4,29	5,19	8,10	12,63
25	4,19	4,69	5,13	6,32	9,72	14,07
32	5,04	5,54	5,63	7,50	11,54	16,41
38		6,16	6,25	7,63	11,88	18,25
45				8,66	13,66	
50				9,57	14,91	21,88
60				11,85	12,63	25,97
70					14,07	30,69
80					16,41	39,82

TORNILLO DIN 7504-P CINCADO TX CON ALAS

FLAT CSK. HEAD TX SELF DRILLING SCREW WITH WINGS DIN 7504-P TX ZINC PLATED
VIS AUTOP. EMPREINTE À SIX LOBES AVEC AILETTES DIN 7504-P TX EN ACIER ZINGUÉ
SENKKOPF-BOHRSCHRAUBE MIT FLÜGEL INNENSECHSRUND, DIN 7504-P TX VERZINKT

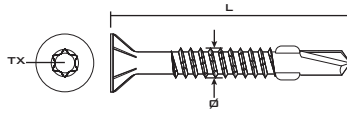
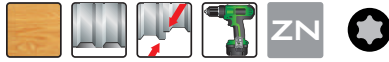

CAJA

CINCADO

CÓDIGO CODE CODE	MEDIDA SIZE MESURE (ØxL) m.m.	LARGO ROSCA THREAD LENGHT LONGUEUR DE FILET m.m.	CAPACIDAD TALADRO MAX. MAX. DRILL CAPACITY CAPACITÉ DU PERCER MAX. m.m.	LLAVE KEY CLÉ TX			PRECIO TARIFA PRICE LIST PRIX TARIFS
							€/100 u.
7504PAT48038	4,8x38	38	4	T-25	200	2.000	11,88
7504PAT48045	4,8x45	45	4	T-25	200	2.000	14,16
7504PAT48060	4,8x60	60	4	T-25	200	1.000	17,13
7504PAT55038	5,5x38	38	5	T-30	200	2.000	15,54
7504PAT55045	5,5x45	45	5	T-30	200	2.000	17,29
7504PAT55050	5,5x50	50	5	T-30	200	2.000	18,75
7504PAT55060	5,5x60	60	5	T-30	100	1.000	23,35
7504PAT55070	5,5x70	60	5	T-30	100	1.000	26,32
7504PAT63040	6,3x40	40	8	T-30	200	2.000	22,13
7504PAT63050	6,3x50	50	8	T-30	200	2.000	27,50
7504PAT63060	6,3x60	60	8	T-30	100	1.000	29,19
7504PAT63070	6,3x70	65	8	T-30	100	1.000	32,85
7504PAT63080	6,3x80	60	8	T-30	100	1.000	38,54
7504PAT63100	6,3x100	70	8	T-30	100	1.000	57,85
7504PAT63120	6,3x120	70	8	T-30	100	1.000	73,54

INSTALACIÓN

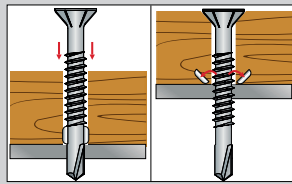

IDEAL PARA LA FIJACIÓN DE PANELES DE MADERA SOBRE SOPORTES METÁLICOS. NO REQUIERE PERFORACIÓN PREVIA.

TORNILLO PANEL SANDWICH PUNTA BROCA Nº3 + EPDM Ø16

SELF DRILLING SCREW POINT Nº3 FOR SANDWICH PANELS + EPDM Ø16
VIS AUTO PERCEUSE POINTE Nº3 POUR PANNEAU SANDWICH + EPDM Ø16
SECHSKANT-BOHRSCHRAUBE SPITZE Nº3 + EPDM Ø16

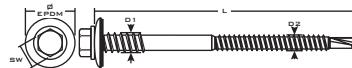

CAJA

CINCADO

CÓDIGO CODE CODE	MEDIDA SIZE MESURE (D 1/D2xL) m.m.	LLAVE KEY CLÉ SW	CAPACIDAD TALADRO DRILL CAPACITY CAPACITÉ DU PERCER m.m.	ESPESOR A FIJAR THICKNESS TO FIX ÉPAISSIEUR m.m.		PRECIO TARIFA PRICE LIST PRIX TARIFS
						€/100 u.
TPSA355063	5,5/6,3x63	8	1,5 - 6	27 - 44	250	17,29
TPSA355082	5,5/6,3x82	8	1,5 - 6	31 - 68	200	21,82
TPSA355098	5,5/6,3x98	8	1,5 - 6	48 - 84	200	25,94
TPSA355115	5,5/6,3x115	8	1,5 - 6	63 - 100	200	30,00

INSTALACIÓN

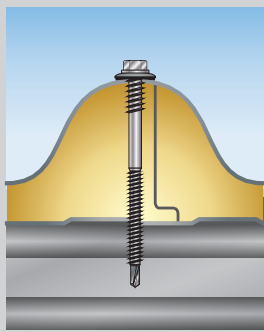

TORNILLO DISEÑADO PARA LA INSTALACIÓN DE PANELES SANDWICH Y CUBIERTAS SIMILARES EN SOPORTES DE ACERO. NO REQUIERE TALADRO PREVIO (MIRAR CAPACIDAD DE TALADRO).

TLLO. VIGA AUTOPERFORANTE PUNTA BROCA Nº5 CINCADO

SELF DRILLING SCREW POINT Nº5 ZINC PLATED
VIS AUTOPERCEUSE POINTE Nº5 EN ACIER ZINGUÉ
SECHSKANT-BOHRSCRAUBE SPITZE Nº5

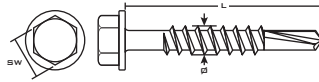
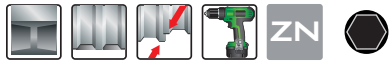

CAJA

CÓDIGO CODE CODE	MEDIDA SIZE MEASURE (ϕ xL) m.m.	LLAVE KEY CLÉ SW	CAPACIDAD TALADRO DRILL CAPACITY CAPACITÉ DU PERCER m.m.	ESPESOR A FIJAR THICKNESS TO FIX ÉPASSIEUR m.m.	CINCO	CINCADO	
						PRECIO TARIFA PRICE LIST PRIX TARIFS €/100 u.	
TV5532	5,5x32	8	4-12	12	500		11,25
TV5538	5,5x38	8	4-12	18	500		12,16
TV5550	5,5x50	8	4-12	30	250		14,50
TV5560	5,5x60	8	4-12	40	250		18,66

INSTALACIÓN

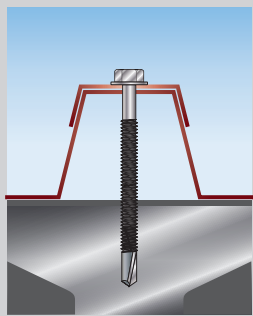

TORNILLO DISEÑADO PARA LA INSTALACIÓN DE CUBIERTAS Y SIMILARES EN VIGA DE ACERO.
NO REQUIERE TALADRO PREVIO (MIRAR CAPACIDAD DE TALADRO).

TLLO. VIGA AUTOPERFORANTE PUNTA BROCA Nº5 CINCADO + EPDM

SELF DRILLING SCREW POINT Nº5 ZINC PLATED + EPDM WASHER
VIS AUTOPERCEUSE POINTE Nº5 EN ACIER ZINGUÉ + RONDELLE EPDM
SECHSKANT-BOHRSCRAUBE SPITZE Nº5 + SCHEIBE EPDM

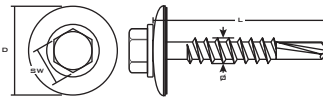

CAJA

CÓDIGO CODE CODE	MEDIDA SIZE MEASURE (ϕ xL-D) m.m.	LLAVE KEY CLÉ SW	CAPACIDAD TALADRO DRILL CAPACITY CAPACITÉ DU PERCER m.m.	ESPESOR A FIJAR THICKNESS TO FIX ÉPASSIEUR m.m.	CINCO	CINCADO	
						PRECIO TARIFA PRICE LIST PRIX TARIFS €/100 u.	
TVA553216	5,5x32 - 16	8	4-12	12	500		15,41
TVA553816	5,5x38 - 16	8	4-12	18	500		16,10
TVA555016	5,5x50 - 16	8	4-12	30	200		18,88
TVA556016	5,5x60 - 16	8	4-12	40	200		23,16
TVA553218	5,5x32 - 18	8	4-12	12	200		16,69
TVA553818	5,5x38 - 18	8	4-12	18	200		17,54
TVA555018	5,5x50 - 18	8	4-12	30	200		20,35
TVA556018	5,5x60 - 18	8	4-12	40	200		24,79

INSTALACIÓN

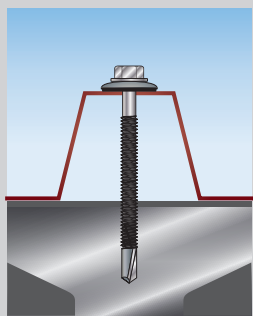

TORNILLO DISEÑADO PARA LA INSTALACIÓN DE CUBIERTAS Y SIMILARES EN VIGA DE ACERO.
LA ARANDELA EPDM PROPORCIONA ESTANQUEIDAD INMEDIATA.
NO REQUIERE TALADRO PREVIO (MIRAR CAPACIDAD DE TALADRO).

NUEVO PRODUCTO / NEW PRODUCT / NOUVEAU PRODUIT

TLLO. AUTORROSCANTE DE ACERO CEMENTADO PARA HORMIGÓN

CONCRETE SELF-TAPPING SCREW - HARDENED STEEL
VIS AUTOTARAUDEUSE EN ACIER CÉMENTE POUR BÉTON
BETONBLECHSCHRAUBE EINSATZGEHÄRTET

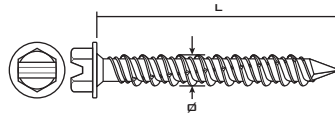

CAJA

CEMENTADO

CÓDIGO CODE CODE	MEDIDA SIZE MEASURE (ØxL) m.m.	LLAVE KEY CLÉ SW	LONGITUD UTIL USEFUL LENGTH LONGUEUR UTILE m.m.	CAJA	PRECIO TARIFA PRICE LIST PRIX TARIFS €/100 u.
HD7665032	6,5x32	8	7	1.000	13,44
HD7665045	6,5x45	8	20	500	14,04
HD7665057	6,5x57	8	32	500	19,63
HD7665070	6,5x70	8	45	500	27,72
HD7665082	6,5x82	8	57	250	28,88
HD7665100	6,5x100	8	75	250	36,07
HD7665125	6,5x125	8	100	250	57,50

NUEVO PRODUCTO / NEW PRODUCT / NOUVEAU PRODUIT

TLLO. AUTORROSCANTE DE ACERO CEMENTADO PARA HORMIGÓN + EPDM Ø16

CONCRETE SELF-TAPPING SCREW WITH EPDM WASHER - HARDENED STEEL
VIS AUTOTARAUDEUSE EN ACIER CÉMENTE POUR BÉTON AVEC RONDELLE EPDM
BETONBLECHSCHRAUBE EINSATZGEHÄRTET MIT SCHEIBE EPDM

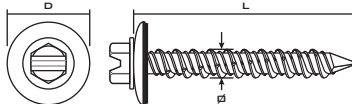
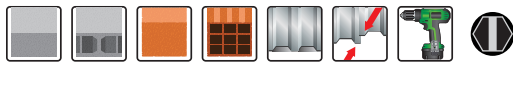

CAJA

CEMENTADO

CÓDIGO CODE CODE	MEDIDA SIZE MEASURE (ØxL-D) m.m.	LLAVE KEY CLÉ SW	LONGITUD UTIL USEFUL LENGTH LONGUEUR UTILE m.m.	CAJA	PRECIO TARIFA PRICE LIST PRIX TARIFS €/100 u.
HD76A1665032	6,5x32 - 16	8	7	1.000	23,07
HD76A1665045	6,5x45 - 16	8	20	500	24,50
HD76A1665057	6,5x57 - 16	8	32	500	31,25
HD76A1665070	6,5x70 - 16	8	45	500	34,82
HD76A1665080	6,5x80 - 16	8	57	250	38,35
HD76A1665100	6,5x100 - 16	8	75	250	43,75
HD76A1665125	6,5x125 - 16	8	100	250	68,75

INSTALACIÓN

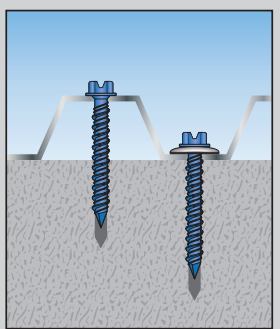

- SE ROSCA DIRECTAMENTE SOBRE HORMIGÓN, CEMENTO, LADRILLOS Y BLOQUES HUECOS.
- AHORRA UNA OPERACIÓN AL SUPRIMIR EL TACO.
- COLOCACIÓN RÁPIDA Y SENCILLA.
- PERMITE LA FIJACIÓN CERCA DE LAS ARISTAS.
- NO AFECTA AL PRENTENSADO DE LA VIGA DE HORMIGÓN.
- FIJACIÓN DESMONTABLE Y SEGURA.
- FIJACIÓN DE CHAPAS SIMPLES Y DE PANELES PREFABRICADOS SOBRE ESTRUCTURAS DE HORMIGÓN.
- RECUBRIMIENTO ANTICORROSIÓN QUE RESISTE 1.000 HORAS EN CÁMARA DE NIEBLA SALINA.

ARANDELA EPDM

EPDM WASHER / RONDELLE AVEC GUARNITURE EN EPDM D'ÉTANCHÉITÉ / SCHEIBE MIT EPDM DICHTUNG

ACERO VULCANIZADO
 VULCANIZED STEEL
 ACIER VULCANISÉE
 COD.: AN / EPDM

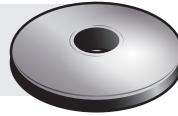
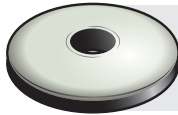
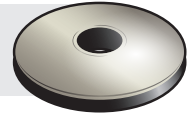
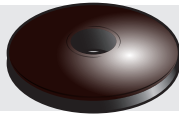
ACERO INOX. A-2
 S.STEEL AISI 304
 ACIER INOX. A-2
 COD.: EPDMA2

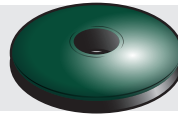
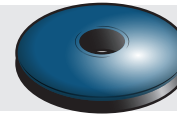
ALUMINIO
 ALUMINIUM
 ALUMINIUM
 COD.: EPDMA

BLANCO GRISÁCEO
 GREY WHITE
 BLANC-GRIS
 RAL: 9002
 COD.: DVBR

MARRÓN OSCURO
 CHOCOLATE BROWN
 MARRON-FONCÉE
 RAL: 8017
 COD.: DVMA

ROJO ÓXIDO
 OXIDE RED
 ROUGE OXYDE
 RAL: 3009
 COD.: DV0X

VERDE MUSGO
 MOSS GREEN
 VERT MOUSSE
 RAL: 6005
 COD.: DVVE

AZUL GENCIANA
 GENTIAN BLUE
 BLEU GENTIANE
 RAL: 5010
 COD.: DVAZ

GRÍS SILVER
 WHITE ALUMINIUM
 ALUMINIUM BLANC
 RAL: 9006
 COD.: DVAL

CAJA

PRECIO TARIFA / PRICE LIST / PRIX TARIFS €100 U.

EMBALAJE / PACKAGING / EMBALLAGE

MEDIDA SIZE / MESURE m.m.	ACERO VULCANIZADO VULCANIZED STEEL ACIER VULCANISÉE	ACERO INOX. A-2 S.STEEL AISI 304 ACIER INOX. A-2	ALUMINIO ALUMINIUM ALUMINIUM	COLOR COLOUR COULEUR
5,1x14	2,60			
5,1x16		10,35	7,75	18,66
6,1x16	2,91	10,35		
6,1x19	3,79	14,00		
6,7x16			7,75	18,66
6,7x19	3,79	14,35	10,79	26,60
6,7x25	6,44	25,85	18,66	43,63
6,7x29			23,44	49,35
6,7x38				109,38
8,5x19	8,33			
8,5x25	9,66			
10,3x25	10,00			

AUTOSERVICIO

CINCADO

CÓDIGO CODE CODE	MEDIDA SIZE MESURE	PRECIO TARIFA PRICE LIST PRIX TARIFS
	∅xL (m.m.)	€/BOLSA
BFEPDM5114	5,1x14	3,50
BFEPDM6116	6,1x16	3,88
BFEPDM6719	6,7x19	5,13
BFEPDM6725	6,7x25	9,04

**PEDIDO MÍNIMO 1 EMBALAJE
 MINIMUM ORDER 1 PACKAGING**
ARANDELA ROMBO CINCADA POLIETILENO

 ZINC PLATED STEEL RHOMBOIDAL GASKET WITH PE FOAM
 RONDELLE RHOMBOÏDALE EN ACIER ZINGUÉ AVEC GUARNITURE EN POLYÉTYLÈNE EXPANSÉ
 VERZINKTE RHOMBUSFÖRMIGE SCHEIBE MIT SCHAUMSTOFFDICHTUNG

ZN
CAJA
CINCADO

CÓDIGO CODE CODE	MEDIDA SIZE MESURE	∅ AGUJERO ∅ HOLE ∅ TROU	PRECIO TARIFA PRICE LIST PRIX TARIFS
	m.m.	m.m.	€/100 U.
AR27	27x27	6,5	13,25
AR30	30x30	7	14,91
AR40	40x40	7	22,72

ARANDELA EPDM PARAGUAS

EPDM UMBRELLA GASKET ASSEMBLED WITH METAL WASHER / RONDELLE EN EPDM EN FORME DE PARAPLUIE AVEC RONDELLE MÉTALLIQUE
LINSENSCHLEIBE AUS EPDM MIT STAHLSCHEIBE MONTIERT



ACERO
STEEL
ACIER
COD.: ANP



ACERO INOX. A-2
S.STEEL AISI 304
ACIER INOX. A-2
COD.: ANPA2



ALUMINIO
ALUMINIUM
ALUMINIUM
COD.: ANPA



BLANCO GRISÁCEO
GREY WHITE
BLANC-GRIS
RAL: 9002
COD.: ANPG

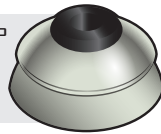

MARRÓN OSCURO
CHOCOLATE BROWN
MARRON-FONCÉE
RAL: 8017
COD.: ANPM



ROJO ÓXIDO
OXIDE RED
ROUGE OXYDE
RAL: 3009
COD.: ANPO

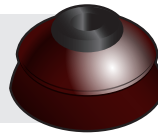

ROJO TEJA
BRICK RED
ROUGE-FONCÉE
RAL: 8004
COD.: ANPT



CAJA

PRECIO TARIFA / PRICE LIST / PRIX TARIFS **€/100 u.**

EMBALAJE / PACKAGING / EMBALLAGE

MEDIDA SIZE / MESURE m.m.	ACERO STEEL ACIER	ACERO INOX. A-2 S.STEEL AISI 304 ACIER INOX. A-2	ALUMINIO NATURAL NATURAL ALUMINIUM ALUMINIUM NATUREL	COLOR COLOUR COULEUR
6x25	20,41	22,50	24,88	24,07

ARANDELA GRECADA ACERO-POLIETILENO / GRECA SERIES 15, 20, 25, 30 Y 40

METAL CAP FOR ROOFING WITH POLYETHYLENE SEALING GASKET CAVALIER AVEC GUARNITURE EN POLYÉTHYLÈNE EXPANSÉ
KALOTTE MIT SCHAUMSTOFFDICHTUNG



Z **ACERO CINCADO**
ZINC PLATED STEEL
ACIER ZINGUÉ
COD.: AEZN



A **ROJO ÓXIDO**
OXIDE RED
ROUGE OXYDE
RAL: 3009
COD.: AEDX



A **MARRÓN OSCURO**
CHOCOLATE BROWN
MARRON-FONCÉE
RAL: 8017
COD.: AEMA



B **VERDE MUSGO**
MOSS GREEN
VERT MOUSSE
RAL: 6005
COD.: AEVE



C **GRÍS SILVER**
WHITE ALUMINIUM
ALUMINIUM BLANC
RAL: 9006
COD.: AEGR



C **AZUL GENCIANA**
GENTIAN BLUE
BLEU GENTIANE
RAL: 5010
COD.: AEAZ



C **ROJO FUEGO**
FIRE RED
ROUGE FEU
RAL: 3000
COD.: AEFU



C **BLANCO PURO**
PURE WHITE
BLANC PUR
RAL: 9010
COD.: AEBL

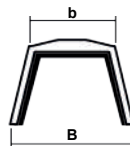
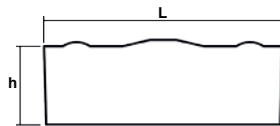

C **GRIS ANTRACITA**
ANTHRACITE GREY
GRIS ANTHRACITE
RAL: 7016
COD.: AEAN

GRECA / SIZE / LARGEUR	BxbxLxh-Ø (mm.)
15	26 x 18 x 50 x 16 - Ø6,5
20	36 x 22 x 50 x 13 - Ø6,5
25	34 x 26 x 50 x 11 - Ø6,5
30	38 x 30 x 50 x 10 - Ø6,5
40	58 x 40 x 50 x 13 - Ø6,5

CAJA

PRECIO TARIFA / PRICE LIST / PRIX TARIFS **€/100 u.**

EMBALAJE / PACKAGING / EMBALLAGE

GRECA SIZE / LARGEUR	ACERO CINCADO - Z ZINC PLATED STEEL - Z ACIER ZINGUÉ - Z	COLOR - A COLOUR - A COULEUR - A	COLOR - B COLOUR - B COULEUR - B	COLOR - C COLOUR - C COULEUR - C
15	21,38	21,38	23,47	26,69
20	21,38	21,38	23,47	26,69
25	21,38	21,38	23,47	26,69
30	21,38	21,38	23,47	26,69
40	29,88	34,97	40,41	40,41



* LOS COLORES IMPRESOS AQUÍ SON APROXIMADOS, PARA SOLICITAR MUESTRAS CONTACTE CON NOSOTROS. / * PRINTED COLORS HERE ARE APPROXIMATE, TO REQUEST SAMPLES CONTACT US. / * LES COULEURS IMPRIMÉES ICI SONT APPROXIMATIVES, POUR COMMANDER DES ÉCHANTILLONS CONTACTEZ-NOUS.

TAPÓN ENVOLVENTE HEXAGONAL

HEXAGONAL PLASTIC CUP / CAPUCHON EN PASTIGUE HEXAGONAL / SECHSKANTKAPPE AUS PLASTIK

BLANCO GRISÁCEO GREY WHITE BLANC-GRIS RAL: 9002 COD.: TEQG9002		MARRÓN OSCURO CHOCOLATE BROWN MARRON-FONCÉE RAL: 8017 COD.: TEQM8017		ROJO ÓXIDO OXIDE RED ROUGE OXYDE RAL: 3009 COD.: TEQR3009		ROJO TEJA BRICK RED ROUGE-FONCÉE RAL: 8004 COD.: TEQR8004	
VERDE MUSGO MOSS GREEN VERT MOUSSE RAL: 6005 COD.: TEQV6005		BLANCO PURO PURE WHITE BLANC PUR RAL: 9010 COD.: TEQB9010		GRIS VENTANA* WINDOW GREY GRIS RAL: 7040 COD.: TEQG7040		VERDE MENTA MINT GREEN VERT MENTHE RAL: 6029 COD.: TEQV6029	
AZUL GENCIANA GENTIAN BLUE BLEU GENTIANE RAL: 5010 COD.: TEQA5010		AZUL LUZ LIGHT BLUE BLEU CLAIR RAL: 5012 COD.: TEQA5012		AZUL PALOMA PIGEON BLUE BLEU PIGEON RAL: 5014 COD.: TEQA5014		NEGRO BLACK NOIR RAL: 9005 COD.: TEQN	

CAJA

LLAVE KEY CLÉ	TORNILLO SCREW VIS			PRECIO TARIFA PRICE LIST PRIX TARIFS
(SW) m.m.	m.m.			€/100 u.
8	4,8 - 5,5	200	5.000	5,84
10	6,3	200	5.000	5,84

REF.: TEQG7040 SOLO DISPONIBLE EN 10MM / REF.: TEQG7040 ONLY AVAILBLE IN 10MM / REF.: TEQG7040 UNIQUEMENT DISPONIBLE EN 10MM

TAPÓN DE PLÁSTICO PARA TUERCAS Y TORNILLOS HEXAGONALES

DIN 933 / 934 / 985

PLASTIC CUP / CAPUCHON EN PASTIGUE / KAPPE AUS PLASTIK



NEGRO
BLACK
NOIR
COD.: TAPONN

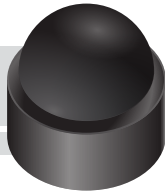

GRIS
GREY
GRIS
COD.: TAPONG

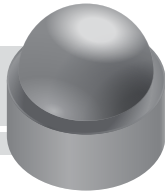

BLANCO
WHITE
BLANC
COD.: TAPONB

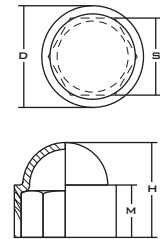

MÉTRICA METRICS MÉTRIQUE m.m.	M	S	H	D		PRECIO TARIFA PRICE LIST / PRIX TARIFS
5	5	8	9,5	10,9	500	18,75
6	6	10	13	12,9	200	21,83
8	7,5	13	15	16,8	200	25,73
10	9	17	19,5	21,3	100	28,53
12	11	19	21,5	23,6	100	42,11
16	14	24	27	29,8	50	60,77

ARANDELA DE NYLON CON TAPÓN Y JUNTA DE ESTANQUEIDAD EN POLIETILENO EXPANDIDO

NYLON WASHER WITH CAP AND PE FOAM SEALING GASKET
RONDELLE AVEC CAPUCHON ET GUARNITURE EN POLYÉTHYLÈNE EXPANSÉ
NYLONSCHLEIBE MIT KAPPE UND SCHAUMSTOFFDICHTUNG



CÓDIGO CODE CODE	GROSOR DE LA LÁMINA SHEET THICKNESS ÉPAISSEUR DE LA TÔLE		PRECIO TARIFA PRICE LIST PRIX TARIFS
	(H) m.m.		€/100 u.
POLICAR06	6	200	118,66
POLICAR10	10	200	118,66
POLICAR16	16	200	118,66

* LOS COLORES IMPRESOS AQUÍ SON APROXIMADOS, PARA SOLICITAR MUESTRAS CONTACTE CON NOSOTROS. / * PRINTED COLORS HERE ARE APPROXIMATE, TO REQUEST SAMPLES CONTACT US. / * LES COULEURS IMPRIMÉES ICI SONT APPROXIMATIVES, POUR COMMANDER DES ÉCHANTILLONS CONTACTEZ-NOUS.

TORNILLO DIN 7981 CINCADO

PAN HEAD SCREW DIN 7981 ZINC PLATED
VIS À TOLE TÊTE CYLINDRIQUE DIN 7981 EN ACIER ZINGUÉ
ZYLINDERKOPF-BLECHSCHRAUBE DIN 7981 VERZINKT

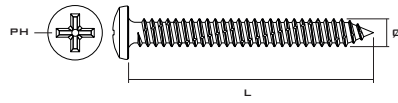
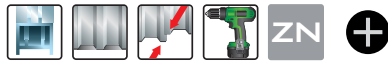

CAJA

COD.: 7981Z

PRECIO TARIFA / PRICE LIST / PRIX TARIFS **€/100 u.**

m.m.	Ø2,9 (PH-1)	Ø3,5 (PH-2)	Ø3,9 (PH-2)	Ø4,2 (PH-2)	Ø4,8 (PH-2)	Ø5,5 (PH-3)	Ø6,3 (PH-3)
6,5	1,00	1,24	1,47				
9,5	1,03	1,24	1,47	1,69	2,16		
13	1,08	1,43	1,70	1,90	2,74	3,77	6,50
16	1,15	1,54	1,90	2,06	2,74	3,94	6,94
19	1,24	1,75	2,03	2,25	3,44	4,00	7,57
22	1,63	1,88	2,54	3,70	4,87	5,60	10,80
25		2,33	2,73	2,96	3,47	5,47	9,30
32		2,63	3,07	3,44	4,72	6,32	10,80
38		2,85	3,90	3,88	5,25	7,04	12,04
45			5,34	4,16	5,44	8,07	13,07
50			5,97	4,66	7,07	8,75	14,04
60				7,84	9,87	10,73	17,90
70				8,97	12,24	12,60	22,44
80					13,00	14,16	22,90
90					15,80	15,57	31,14
100					18,97	22,07	33,30
110					22,20	28,77	
120					27,57	30,87	

BLISTERS

COD.: B7981Z

PRECIO TARIFA / PRICE LIST / PRIX TARIFS **€/BLISTER**



EMBALAJE / QUANTITY / EMBALLAGE **X 12**

m.m.	Ø3,5 (PH-2)	Ø3,9 (PH-2)	Ø4,2 (PH-2)	Ø4,8 (PH-2)	Ø5,5 (PH-3)			
9,5	1,60	40	1,60	20	1,60	15		
13	1,60	20	1,60	20	1,60	15		
16	1,60	20	1,60	20	1,60	10		
19	1,60	20	1,60	10	1,60	10		
25			1,60	10	1,60	10		
32				1,60	10	1,60	10	
38				1,60	10	1,60	10	
45				1,60	10	1,60	10	
50				1,60	10	1,60	10	
60					1,60	4	1,60	4
70					1,60	4	1,60	4
80					1,60	4	1,60	4
90					1,60	4	1,60	4
100					1,60	4	1,60	4

AUTOSERVICIO

CINCADO

CÓDIGO CODE CODE	MEDIDA SIZE MEASURE	250	200	150	120	PRECIO TARIFA PRICE LIST PRIX TARIFS
	ØxL (m.m.)					€/BOLSA
BF7981Z35009	3,5x9,5	250	12			3,57
BF7981Z35013	3,5x13	200	12			3,50
BF7981Z35016	3,5x16	200	12			3,85
BF7981Z35019	3,5x19	200	12			4,25
BF7981Z35025	3,5x25	200	12			5,69
BF7981Z39009	3,9x9,5	200	12			3,54
BF7981Z39013	3,9x13	200	12			3,97
BF7981Z39016	3,9x16	200	12			4,57
BF7981Z39019	3,9x19	150	12			3,85
BF7981Z39025	3,9x25	100	12			3,32
BF7981Z42013	4,2x13	200	12			4,54
BF7981Z42016	4,2x16	200	12			5,47
BF7981Z42019	4,2x19	150	12			4,29
BF7981Z42025	4,2x25	100	12			3,57
BF7981Z42032	4,2x32	100	12			4,19
BF7981Z42038	4,2x38	75	12			3,66
BF7981Z42050	4,2x50	50	12			2,97

AUTOSERVICIO

CINCADO

CÓDIGO CODE CODE	MEDIDA SIZE MEASURE	150	100	75	50	PRECIO TARIFA PRICE LIST PRIX TARIFS
	ØxL (m.m.)					€/BOLSA
BF7981Z48013	4,8x13	150	12			4,63
BF7981Z48016	4,8x16	100	12			3,57
BF7981Z48019	4,8x19	100	12			3,97
BF7981Z48025	4,8x25	100	12			4,79
BF7981Z48032	4,8x32	100	12			5,22
BF7981Z48038	4,8x38	100	12			6,60
BF7981Z48045	4,8x45	75	12			5,13
BF7981Z48050	4,8x50	50	12			4,10
BF7981Z48060	4,8x60	50	12			5,13
BF7981Z48070	4,8x70	40	12			4,88
BF7981Z48080	4,8x80	25	12			3,63
BF7981Z55019	5,5x19	100	12			5,25
BF7981Z55025	5,5x25	100	12			7,19
BF7981Z55032	5,5x32	100	12			7,32
BF7981Z55038	5,5x38	75	12			6,25

PEDIDO MÍNIMO 1 EMBALAJE
MINIMUM ORDER 1 PACKAGING

TORNILLO DIN 7982 CINCADO

FLAT CSK HEAD SCREW DIN 7982 ZINC PLATED
VIS À TOLE TÊTE FRAISÉE DIN 7982 EN ACIER ZINGUÉ
SENKKOPF-BLECHSCHRAUBE DIN 7982 VERZINKT

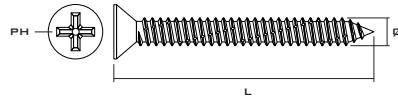
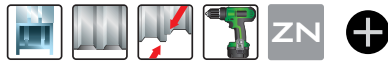

CAJA

CINCADO

COD.: 7982Z

PRECIO TARIFA / PRICE LIST / PRIX TARIFS **€/100 u.**

m.m.	Ø2,9 (PH-1)	Ø3,5 (PH-2)	Ø3,9 (PH-2)	Ø4,2 (PH-2)	Ø4,8 (PH-2)	Ø5,5 (PH-3)	Ø6,3 (PH-3)
6,5	1,00						
9,5	1,03	1,24	1,39	1,65			
13	1,08	1,34	1,59	1,85	2,72	3,77	
16	1,13	1,54	1,75	2,06	2,74	3,77	
19	1,24	1,75	1,90	2,16	2,98	4,00	7,57
22	1,63	1,85	2,19	3,70	3,70	4,64	
25	1,54	2,30	2,43	2,83	3,79	4,82	9,30
32		2,63	3,03	3,22	4,38	5,72	10,80
38		2,93	3,90	3,91	4,91	6,47	12,04
45			5,34	4,10	5,20	9,75	13,07
50				6,64	7,07	9,82	14,04
60					9,87	11,32	17,90
70					12,24	14,16	22,44

BLISTERS

CINCADO

COD.: 87982Z

PRECIO TARIFA / PRICE LIST / PRIX TARIFS **€/BLISTER**



EMBALAJE / QUANTITY / EMBALLAGE **X 12**

m.m.	Ø3,5 (PH-2)	Ø3,9 (PH-2)	Ø4,2 (PH-2)	Ø4,8 (PH-2)	Ø5,5 (PH-3)
9,5	1,60	1,60	1,60		
13	1,60	1,60	1,60	1,60	
16		1,60		1,60	1,60
19	1,60	1,60	1,60	1,60	1,60
25		1,60	1,60	1,60	1,60
32			1,60	1,60	1,60
38			1,60	1,60	1,60
45				1,60	
50			1,60	1,60	1,60

AUTOSERVICIO

CINCADO

CÓDIGO CODE CODE	MEDIDA SIZE MEASURE	PRECIO TARIFA PRICE LIST PRIX TARIFS
	ØxL (m.m.)	€/BOLSA
BF7982Z35009	3,5x9,5	3,29
BF7982Z35013	3,5x13	3,70
BF7982Z35016	3,5x16	4,25
BF7982Z35019	3,5x19	4,83
BF7982Z35025	3,5x25	2,54
BF7982Z39016	3,9x16	3,91
BF7982Z39019	3,9x19	4,32
BF7982Z39025	3,9x25	2,97

AUTOSERVICIO

CINCADO

CÓDIGO CODE CODE	MEDIDA SIZE MEASURE	PRECIO TARIFA PRICE LIST PRIX TARIFS
	ØxL (m.m.)	€/BOLSA
BF7982Z42016	4,2x16	4,22
BF7982Z42019	4,2x19	4,85
BF7982Z42025	4,2x25	3,22
BF7982Z42032	4,2x32	3,85
BF7982Z48019	4,8x19	3,57
BF7982Z48025	4,8x25	4,44
BF7982Z48032	4,8x32	4,69
BF7982Z55032	5,5x32	5,10
BF7982Z55038	5,5x38	5,29

PEDIDO MÍNIMO 1 EMBALAJE / MINIMUM ORDER 1 PACKAGING
COMMANDE MINIMALE 1 EMBALLAGE / MINDESTBESTELLMENGE 1 VERPACKUNG

TUERCA CINCADA PARA ATORNILLAR EN MADERA

ZINC PLATED NUT FOR SCREW IN WOOD
ÉCROU EN ACIER ZINGUÉ POUR VIS À BOIS
MUTTER VERZINKT FÜR EINSCHRAUBEN AUF HOLZ

ZN

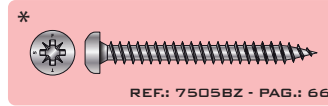

CAJA

CÓDIGO CODE CODE	MÉTRICA METRICS MÉTRIQUE	TORNILLO RECOMENDADO* RECOMMENDED SCREW VIS RECOMMANDÉ	CAJA	CINCADO PRECIO TARIFA PRICE LIST PRIX TARIFS
	(M) m.m.	m.m.		€/100 u.
TCMZ10	M10	DIN 7505B ZN - Ø3,5x16	200	27,33

TUERCA CINCADA PARA CLAVAR EN MADERA

ZINC PLATED NUT FOR NAIL IN WOOD
ÉCROU EN ACIER ZINGUÉ POUR CLOUVER À BOIS
MUTTER VERZINKT FÜR ZUNAGELN AUF HOLZ

ZN

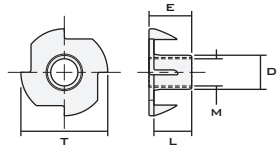

CAJA

CÓDIGO CODE CODE	MÉTRICA METRICS MÉTRIQUE	D1	E	L	T	CAJA	CINCADO PRECIO TARIFA PRICE LIST PRIX TARIFS
	(M) m.m.	m.m.	m.m.	m.m.	m.m.		€/100 u.
TCLZ05	M 5	6	8	8	18	200	7,41
TCLZ06	M 6	7,5	9	8	19	200	8,60
TCLZ08	M 8	9	11	10	22	200	12,85
TCLZ10	M10	11	12,5	11	25,5	200	18,47

MALETÍN SURTIDO HOGAR

ASSORTMENT BRIEFCASE HOME / MALLETT ASSORTIMENT FOYER / HANDKOFFER SORTIERT ZUHAUSE



MEDIDAS INCLUIDAS EN EL MALETÍN / MEASURES INCLUDED IN THE BRIEFCASE / MESURES INCLUSES DANS LE MALLETT

TACO NYLON		TACO NYLON GTX		TLLO. DIN 571 ZN	
MEDIDA SIZE / MESURE m.m.	CANTIDAD QUANTITY QUANTITÉ	MEDIDA SIZE / MESURE m.m.	CANTIDAD QUANTITY QUANTITÉ	MEDIDA SIZE / MESURE m.m.	CANTIDAD QUANTITY QUANTITÉ
6x30	50	5x25	50	5x45	25
8x40	25	6x30	25		

CÁNCAMO CERRADO ZN		CÁNCAMO ABIERTO ZN		ALCAYATA ZN		TLLO. DIN 7505A BC		TACOS CARTÓN-YESO	
MEDIDA SIZE / MESURE m.m.	CANTIDAD QUANTITY QUANTITÉ	MEDIDA SIZE / MESURE m.m.	CANTIDAD QUANTITY QUANTITÉ	MEDIDA SIZE / MESURE m.m.	CANTIDAD QUANTITY QUANTITÉ	MEDIDA SIZE / MESURE m.m.	CANTIDAD QUANTITY QUANTITÉ	MEDIDA SIZE / MESURE m.m.	CANTIDAD QUANTITY QUANTITÉ
14x30	100	17x40	100	17x35	100	4,5x30	100	ALAS 8x38	15
17x35	50	18x50	50	18x50	50	4,5x35	50	NYLON 37	25
18x40	50	19x60	25	19x60	40	5x50	25	ZAMAK 37	25
19x50	25								

CÓDIGO CODE / CODE	DESCRIPCIÓN DESCRIPTION / DESCRIPTION
MAGA	MALETÍN SURTIDO HOGAR

PRECIO TARIFA / PRICE LIST	PRECIO TARIFA / PRICE LIST
€/UNIDAD	€/100 u.
68,75	6.875,00

MALETÍN ANILLA DE SEGURIDAD DIN 471-E

DIN 471-E CASE / MALLETTE DE DIN 471-E / DIN 471-E KOFFER



MEDIDAS INCLUIDAS EN EL MALETÍN / MEASURES INCLUDED IN THE BRIEFCASE / MESURES INCLUSES DANS LE MALLETTE

MEDIDA SIZE / MESURE m.m.	CANTIDAD QUANTITY QUANTITÉ	MEDIDA SIZE / MESURE m.m.	CANTIDAD QUANTITY QUANTITÉ
∅ 5	200	∅19	50
∅ 8	200	∅20	50
∅ 9	200	∅21	50
∅10	200	∅22	20
∅11	200	∅24	20
∅12	100	∅25	20
∅13	100	∅28	20
∅14	100	∅30	20
∅15	100	∅35	10
∅16	100	∅38	10
∅17	50	∅40	10
∅18	50		

CÓDIGO / CODE / CODE DESCRIPCIÓN / DESCRIPTION / DESCRIPTION

M471 MALETÍN DE ANILLAS DE SEGURIDAD DIN 471-E

PRECIO TARIFA / PRICE LIST PRECIO TARIFA / PRICE LIST

€/UNIDAD €/100 u.
125,00 12.500,00

MALETÍN ANILLA DE SEGURIDAD DIN 472-I

DIN 472-I CASE / MALLETTE DE DIN 472-I / DIN 472-I KOFFER



MEDIDAS INCLUIDAS EN EL MALETÍN / MEASURES INCLUDED IN THE BRIEFCASE / MESURES INCLUSES DANS LE MALLETTE

MEDIDA SIZE / MESURE m.m.	CANTIDAD QUANTITY QUANTITÉ	MEDIDA SIZE / MESURE m.m.	CANTIDAD QUANTITY QUANTITÉ
∅ 8	200	∅21	50
∅ 9	200	∅22	50
∅10	200	∅24	50
∅12	200	∅26	50
∅13	200	∅28	20
∅14	100	∅30	20
∅15	100	∅32	20
∅16	100	∅35	20
∅17	100	∅40	20
∅19	100	∅42	10
∅20	50		

CÓDIGO / CODE / CODE DESCRIPCIÓN / DESCRIPTION / DESCRIPTION

M472 MALETÍN DE ANILLAS DE SEGURIDAD DIN 472-I

PRECIO TARIFA / PRICE LIST PRECIO TARIFA / PRICE LIST

€/UNIDAD €/100 u.
125,00 12.500,00

MALETÍN PASADOR ELÁSTICO DIN 1481

DIN 1481 CASE / MALLETTE DE DIN 1481 / DIN 1481 KOFFER



MEDIDAS INCLUIDAS EN EL MALETÍN / MEASURES INCLUDED IN THE BRIEFCASE / MESURES INCLUSES DANS LE MALLETTE

MEDIDA SIZE / MESURE m.m.	CANTIDAD QUANTITY QUANTITÉ	MEDIDA SIZE / MESURE m.m.	CANTIDAD QUANTITY QUANTITÉ
∅ 2x10	400	∅ 5x20	50
∅ 2x24	400	∅ 5x30	50
∅ 3x 8	200	∅ 5x50	50
∅ 3x12	200	∅ 6x12	50
∅ 3x20	200	∅ 6x24	50
∅ 3x50	100	∅ 6x40	50
∅ 4x12	100	∅ 8x20	20
∅ 4x20	100	∅ 8x36	20
∅ 4x26	100	∅ 8x60	20
∅ 4x40	100	∅10x40	15
∅ 5x10	50		

CÓDIGO / CODE / CODE DESCRIPCIÓN / DESCRIPTION / DESCRIPTION

M1481 MALETÍN DE PASADORES ELÁSTICOS DIN 1481

PRECIO TARIFA / PRICE LIST PRECIO TARIFA / PRICE LIST

€/UNIDAD €/100 u.
125,00 12.500,00

TORNILLO DIN 7505-A INOXIDABLE A-2 PZ

CHIPBOARD SCREW PZ STAINLESS STEEL AISI 304
VIS À BOIS PZ EN ACIER INOX A-2
SENKKOPF-SPANPLATTENSCHRAUBE - EDELSTAHL A-2

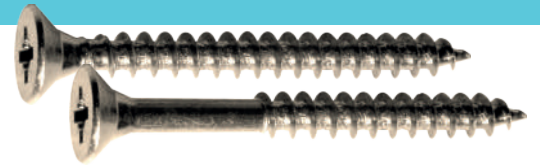
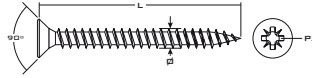

CAJA

INOX. A-2

COD.: 7505AA2

PRECIO TARIFA / PRICE LIST / PRIX TARIFS **€/100 u.**

m.m.	Ø3 (PZ-1)	Ø3,5 (PZ-2)	Ø4 (PZ-2)	Ø4,5 (PZ-2)	Ø5 (PZ-2)	Ø6 (PZ-3)
16	13,20	15,04	18,34	28,24		
20	14,36	16,10	19,42	25,33	29,03	
25	15,04	17,15	20,58	27,71	30,35	
30	16,05	17,95	21,38	29,56	32,20	62,28
35	19,63	20,85	25,07	31,67	36,42	67,03
40	21,96	22,43	26,92	35,36	39,06	70,73
45			28,50	38,27	45,39	73,89
50			30,08	57,00	47,50	79,17
60			46,45	69,67	65,45	87,09
70					84,45	110,84
80					100,28	131,95
90					137,23	182,09
100					182,09	237,51
110						311,40
120						401,13
130						527,80
140						680,86
150						886,70

AUTOSERVICIO

INOX. A-2

CÓDIGO CODE CODE	MEDIDA SIZE MEASURE			PRECIO TARIFA PRICE LIST PRIX TARIFS
	ØxL (m.m.)			€/BOLSA
BF7505A230016	3x16	150	12	5,77
BF7505A230020	3x20	150	12	6,34
BF7505A230025	3x25	100	12	5,45
BF7505A235020	3,5x20	100	12	5,13
BF7505A235025	3,5x25	100	12	6,35
BF7505A235030	3,5x30	100	12	7,08
BF7505A235035	3,5x35	100	12	8,06
BF7505A240020	4x20	100	12	5,59
BF7505A240025	4x25	100	12	7,58
BF7505A240030	4x30	100	12	7,99
BF7505A240035	4x35	100	12	8,96
BF7505A240040	4x40	100	12	9,87
BF7505A245030	4,5x30	100	12	10,27
BF7505A245035	4,5x35	100	12	10,85
BF7505A245040	4,5x40	100	12	12,56
BF7505A245045	4,5x45	50	12	8,23
BF7505A250030	5x30	100	12	12,90
BF7505A250035	5x35	75	12	14,78
BF7505A250040	5x40	50	12	15,46
BF7505A250050	5x50	50	12	9,77
BF7505A250060	5x60	50	12	11,86
BF7505A250070	5x70	30	12	13,13
BF7505A250080	5x80	25	12	11,12
BF7505A250090	5x90	20	12	9,60
BF7505A260060	6x60	25	12	8,58
BF7505A260070	6x70	20	12	9,88
BF7505A260080	6x80	15	12	11,66
BF7505A260090	6x90	12	12	6,13
BF7505A260100	6x100	10	12	6,55

BLISTERS

INOX. A-2

CÓDIGO CODE CODE	MEDIDA SIZE MEASURE			PRECIO TARIFA PRICE LIST PRIX TARIFS
	ØxL (m.m.)			€/BLISTER
B7505AA230010	3x10	20	20	2,89
B7505AA230016	3x16	20	20	2,89
B7505AA230020	3x20	20	20	2,89
B7505AA230030	3x30	20	20	2,89
B7505AA235020	3,5x20	20	20	2,89
B7505AA235025	3,5x25	20	20	2,89
B7505AA235030	3,5x30	20	20	2,89
B7505AA235040	3,5x40	15	20	2,89
B7505AA240020	4x20	20	20	2,89
B7505AA240025	4x25	15	20	2,89
B7505AA240030	4x30	15	20	2,89
B7505AA240040	4x40	12	20	2,89
B7505AA240050	4x50	10	20	2,89
B7505AA245025	4,5x25	15	20	2,89
B7505AA245030	4,5x30	10	20	2,89
B7505AA245035	4,5x35	8	20	2,89
B7505AA245040	4,5x40	8	20	2,89
B7505AA245050	4,5x50	8	20	2,89
B7505AA245060	4,5x60	8	20	2,89
B7505AA250025	5x25	8	20	2,89
B7505AA250030	5x30	8	20	2,89
B7505AA250040	5x40	8	20	2,89
B7505AA250050	5x50	8	20	2,89
B7505AA250060	5x60	8	20	2,89
B7505AA260030	6x30	6	20	2,89
B7505AA260040	6x40	6	20	2,89
B7505AA260050	6x50	4	20	2,89
B7505AA260060	6x60	4	20	2,89
B7505AA260070	6x70	4	20	2,89
B7505AA260100	6x100	4	20	2,89

PEDIDO MÍNIMO 1 EMBALAJE / MINIMUM ORDER 1 PACKAGING
COMMANDE MINIMALE 1 EMBALLAGE / MINDESTBESTELLMENGE 1 VERPACKUNG

TORNILLO BARRAQUERO DIN 571 INOXIDABLE A-2

HEXAGON WOOD SCREW - STAINLESS STEEL AISI 304
TIRAFOND À VISSER AVEC TÊTE HEXAGONALE EN ACIER INOX. A-2
SECHSKANT-HOLZSCHRAUBE - EDELSTAHL A-2

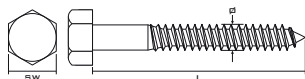

CAJA

INOX. A-2

COD.: 571A2

PRECIO TARIFA / PRICE LIST / PRIX TARIFS **€/100 u.**

m.m.	Ø5 (SW-8)	Ø6 (SW-10)	Ø8 (SW-13)	Ø10 (SW-17)	Ø12 (SW-19)
30	48,53	47,58	118,97		
35	57,79	52,78			
40	59,01	55,21	99,91	226,48	
45	70,20	63,86			
50	71,38	65,66	110,39	178,90	842,21
60	133,24	80,89	133,24	199,85	926,90
70		130,37	147,49	236,01	1.010,63
80		152,27	185,57	266,46	1.095,34
90		205,84	290,26	352,10	1.194,31
100		226,95	332,12	399,70	1.319,92
110			535,72	671,86	
120			606,97	742,27	1.636,18
130				1.010,74	1.712,95
140				1.425,06	2.190,37
150				1.609,79	2.427,88
160					3.193,19

AUTOSERVICIO

INOX. A-2

BLISTERS

INOX. A-2

CÓDIGO CODE CODE	MEDIDA SIZE MESURE			PRECIO TARIFA PRICE LIST PRIX TARIFS
	ØxL (m.m.)			€/BOLSA
BF571A206040	6x40	25	12	7,02
BF571A206050	6x50	25	12	8,53
BF571A206060	6x60	25	12	10,35
BF571A206070	6x70	15	12	6,63
BF571A206080	6x80	15	12	7,59
BF571A208050	8x50	15	12	8,70
BF571A208060	8x60	15	12	11,14
BF571A208070	8x70	10	12	7,84
BF571A208080	8x80	10	12	8,90
BF571A208090	8x90	10	12	11,91
BF571A208100	8x100	10	12	12,50

CÓDIGO CODE CODE	MEDIDA SIZE MESURE			PRECIO TARIFA PRICE LIST PRIX TARIFS
	ØxL (m.m.)			€/BLISTER
B571A205030	5x30	4	20	2,89
B571A205040	5x40	4	20	2,89
B571A205050	5x50	4	20	2,89
B571A206030	6x30	4	20	2,89
B571A206040	6x40	4	20	2,89
B571A206050	6x50	4	20	2,89
B571A206060	6x60	4	20	2,89
B571A206070	6x70	4	20	2,89
B571A208040	8x40	2	20	2,89
B571A208050	8x50	2	20	2,89
B571A208060	8x60	2	20	2,89
B571A208080	8x80	2	20	2,89
B571A210070	10x70	2	20	2,89
B571A210080	10x80	2	20	2,89
B571A210100	10x100	2	20	2,89

**PEDIDO MÍNIMO 1 EMBALAJE / MINIMUM ORDER 1 PACKAGING
COMMANDE MINIMALE 1 EMBALLAGE / MINDESTBESTELLMENGE 1 VERPACKUNG**

TORNILLO ABRAZADERA DOBLE ROSCA INOXIDABLE A-2

DOUBLE THREADED SCREW STAINLESS STEEL AISI 304
VIS POUR COLLIER ET CRAMPON EN ACIER INOX. A-2
EDELSTAHL A-2 VERBINDUNGSSCHRAUBE MIT DOPPELTEM GEWINDE



CAJA

INOX. A-2

CÓDIGO CODE CODE	MEDIDA SIZE MESURE		PRECIO TARIFA PRICE LIST PRIX TARIFS
	m.m.		€/100 u.
DRA2630	6x30	100	34,69
DRA2640	6x40	100	36,07
DRA2850	8x50	100	71,10

ESPÁRRAGO DOBLE ROSCA INOXIDABLE A-2

STAINLESS STEEL AISI 304 DOWEL THREAD SCREW
VIS COMBI AVEC SECTION HEXAGONAL EN ACIER INOX. A-2
SCHRAUBE MIT DOPPELTEM GEWINDE - EDELSTAHL A-2

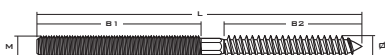

CAJA

CÓDIGO CODE CODE	MEDIDA SIZE MEASURE (MxL) m.m.	Ø m.m.	B1 m.m.	B2 m.m.		INOX. A-2	
						PRECIO TARIFA PRICE LIST PRIX TARIFS	€/100 u.
EDRA208060	8x60	7	20	37	100	81,25	
EDRA210100	10x100	9	30	57	50	209,91	

CÁNCAMO CERRADO INOXIDABLE A-2

STAINLESS STEEL AISI 304 EYE WOOD SCREW
VIS OUILLET À BOIS EN ACIER INOX. A-2
HOLZ-AUGENSCHRAUBE - EDELSTAHL A-2

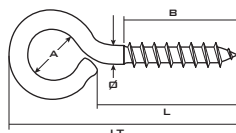
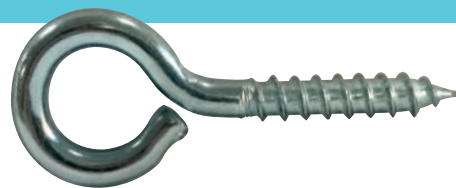

CAJA

CÓDIGO CODE CODE	MEDIDA SIZE MEASURE (ØxL) m.m.	A m.m.	B m.m.	LT m.m.		INOX. A-2	
						PRECIO TARIFA PRICE LIST PRIX TARIFS	€/100 u.
CCA225010	2,5x10	5	6	20	200	23,13	
CCA230016	3x16	6	10	28	200	26,57	
CCA230020	3x20	6	10	32	200	27,32	
CCA235020	3,5x20	9	12	36	200	33,13	
CCA240025	4x25	10	15	43	100	46,57	
CCA240030	4x30	12	18	50	100	51,88	
CCA250040	5x40	14	24	64	100	112,50	
CCA250060	5x60	16	30	86	100	128,13	
CCA260060	6x60	18	35	90	100	166,88	
CCA260080	6x80	18	42	110	50	179,69	
CCA260100	6x100	18	42	130	50	196,57	

CÁNCAMO ABIERTO INOXIDABLE A-2

STAINLESS STEEL AISI 304 HOOK WOOD SCREW
VIS CROCHER ROND À BOIS EN ACIER INOX. A-2
HOLZSCHRAUBE MIT RUNDHAKEN - EDELSTAHL A-2

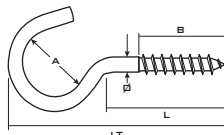

CAJA

CÓDIGO CODE CODE	MEDIDA SIZE MEASURE (ØxL) m.m.	A m.m.	B m.m.	LT m.m.		INOX. A-2	
						PRECIO TARIFA PRICE LIST PRIX TARIFS	€/100 u.
CAA225010	2,5x10	8	6	23	200	28,13	
CAA225012	2,5x12	8	7	25	200	29,57	
CAA230016	3x16	10	10	32	200	30,00	
CAA235020	3,5x20	16	12	43	200	41,25	
CAA232025	3,5x25	16	15	48	100	51,25	
CAA240030	4x30	16	18	54	100	58,75	
CAA245030	5x30	20	15	59	100	103,13	
CAAS50035	5x35	25	18	70	100	110,63	
CAA250040	5x40	25	25	75	100	168,75	
CAA260060	6x60	29	30	101	100	187,19	

TORNILLO DIN 912 INOXIDABLE A-2

CYLINDER HEAD HEXAGONAL RECESS SCREW DIN 912 STAINLESS STEEL AISI 304
 VIS FILETAGE MÉTRIQUE TÊTE CYLINDRIQUE À SIX PANS CREUX DIN 912 EN ACIER INOX. A-2
 ZYLINDERSCHRAUBE MIT INNENSECHSKANT DIN 912 - EDELSTAHL A-2

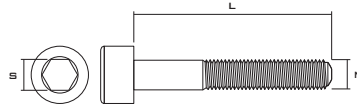

CAJA 

INOX. A-2



COD.: 912A2

PRECIO TARIFA / PRICE LIST / PRIX TARIFS **€/100 u.**

m.m.	M3 (S-2,5)	M4 (S-3)	M5 (S-4)	M6 (S-5)	M8 (S-6)	M10 (S-8)	M12 (S-10)	M14 (S-12)	M16 (S-14)	M20 (S-17)
6	12,56									
8	12,85	17,21								
10	13,09	16,36	17,89	24,36	46,39					
12	13,80	15,33	17,76	22,09	47,11					
16	14,75	16,89	18,00	20,93	41,88	111,34				
20	18,08	17,23	19,21	24,28	46,02	80,44				
25	23,80	19,63	23,80	26,44	48,69	84,87	118,02	356,87		
30	27,60	22,93	28,08	31,40	54,39	91,31	125,30	386,35	336,37	
35		26,42	32,51	34,25	62,28	101,55	136,81	413,95	385,43	
40		28,98	35,78	37,50	68,83	109,44	150,85	424,43	423,48	1.376,50
45		38,05	43,07	42,91	75,79	124,14	164,78	464,41	461,53	1.463,06
50		43,78	44,97	43,83	82,13	131,21	178,82	504,37	485,34	1.566,51
60			65,87	51,38	95,22	147,49	206,90	605,91	563,37	1.743,85
70				77,09	125,62	170,58	244,90	686,14	647,11	1.929,64
80				89,46	173,54	191,49	301,90	785,37	760,38	2.113,31
90				128,36	213,23	228,85	371,57	861,24	889,79	2.282,21
100				160,66	234,34	266,01	424,35	964,82	964,82	2.461,66
110					403,77	488,22	641,28	1.232,41	1.232,41	2.765,67
120					480,30	548,91	715,17	1.432,98	1.432,98	3.359,45
130					551,55	612,25	802,26	1.657,29	1.657,29	3.821,27
140									2.639,00	4.528,52
150									3.377,92	5.660,66



AUTOSERVICIO

INOX. A-2

CÓDIGO CODE CODE	MEDIDA SIZE MESURE			PRECIO TARIFA PRICE LIST PRIX TARIFS
	MxL (m.m.)			€/BOLSA
BF912A204010	4x10	100	12	9,16
BF912A204016	4x16	100	12	10,98
BF912A204020	4x20	75	12	8,72
BF912A205010	5x10	100	12	10,66
BF912A205016	5x16	75	12	10,44
BF912A205020	5x20	75	12	10,47
BF912A205025	5x25	75	12	12,44
BF912A205030	5x30	75	12	14,63
BF912A206010	6x10	75	12	12,69
BF912A206016	6x16	75	12	12,93
BF912A206020	6x20	50	12	10,30
BF912A206025	6x25	50	12	10,79
BF912A206030	6x30	50	12	12,46

BLISTERS

INOX. A-2

CÓDIGO CODE CODE	MEDIDA SIZE MESURE			PRECIO TARIFA PRICE LIST PRIX TARIFS
	MxL (m.m.)			€/100 u.
B912A205016	5x16	6	15	2,89
B912A205020	5x20	6	15	2,89
B912A205025	5x25	6	15	2,89
B912A205030	5x30	6	15	2,89
B912A205040	5x40	6	15	2,89
B912A206016	6x16	4	15	2,89
B912A206020	6x20	4	15	2,89
B912A206025	6x25	4	15	2,89
B912A206030	6x30	4	15	2,89
B912A206040	6x40	4	15	2,89
B912A208020	8x20	4	15	2,89
B912A208025	8x25	4	15	2,89
B912A208030	8x30	4	15	2,89
B912A208040	8x40	2	15	2,89
B912A208050	8x50	2	15	2,89
B912A208060	8x60	2	15	2,89

**PEDIDO MÍNIMO 1 EMBALAJE / MINIMUM ORDER 1 PACKAGING
 COMMANDE MINIMALE 1 EMBALLAGE / MINDESTBESTELLMENGE 1 VERPACKUNG**

TORNILLO DIN 933 INOXIDABLE A-2

HEXAGON HEAD SCREW DIN 933 - STAINLESS STEEL AISI 304
VIS TÊTE HEXAGONALE DIN 933 EN ACIER INOX. A-2
SECHSKANTNSCHRAUBE DIN 933 - EDELSTAHL A-2

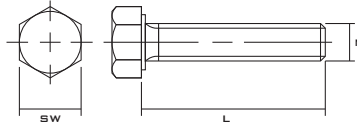

CAJA

INOX. A-2

COD.: 933A2

PRECIO TARIFA / PRICE LIST / PRIX TARIFS **€/100 u.**

m.m.	M6 (SW-10)	M8 (SW-13)	M10 (SW-17)	M12 (SW-19)	M14 (SW-22)	M16 (SW-24)	M18 (SW-27)	M20 (SW-30)
10	18,47	37,21						
12	17,21	36,37						
16	17,42	33,99	68,19					
20	19,21	36,84	69,25	115,06	250,28			
25	22,17	41,59	72,63	110,20	244,90	248,38		
30	25,76	46,24	79,59	114,43	221,68	251,23	491,91	484,39
35	29,13	50,88	86,77	123,93	232,23	242,79	508,80	462,35
40	32,20	56,16	91,63	132,58	242,79	255,46	525,69	477,13
45	35,26	61,75	102,39	145,46	261,79	278,68	555,25	504,58
50	38,21	69,04	109,15	153,06	276,57	291,35	574,25	521,47
60	49,48	78,75	124,98	174,39	314,57	331,46	641,80	582,69
70	58,48	94,37	141,03	196,13	350,46	369,46	713,59	648,14
80	68,51	105,64	169,40	244,90	386,35	409,57	781,14	709,36
90	77,09	117,04	190,85	268,12	485,58	483,46	848,70	770,59
100	83,81	131,32	215,34	291,35	529,91	523,58	916,26	831,81

AUTOSERVICIO

INOX. A-2

CÓDIGO CODE CODE	MEDIDA SIZE MEASURE			PRECIO TARIFA PRICE LIST PRIX TARIFS
	MxL (m.m.)			€/BOLSA
BF933A204020	4x20	50	12	6,85
BF933A204030	4x30	50	12	8,58
BF933A205010	5x10	50	12	4,95
BF933A205020	5x20	50	12	6,93
BF933A205025	5x25	50	12	8,45
BF933A205030	5x30	50	12	8,52
BF933A206010	6x10	50	12	6,85
BF933A206016	6x16	50	12	8,00
BF933A206020	6x20	50	12	9,91
BF933A206025	6x25	50	12	10,60
BF933A206030	6x30	50	12	10,96
BF933A206040	6x40	25	12	7,37
BF933A206050	6x50	25	12	8,23
BF933A206060	6x60	25	12	9,58
BF933A208016	8x16	25	12	7,97
BF933A208020	8x20	25	12	9,27
BF933A208025	8x25	25	12	9,86
BF933A208030	8x30	25	12	10,77
BF933A208040	8x40	25	12	13,24
BF933A208050	8x50	10	12	6,68
BF933A208060	8x60	10	12	7,26

BLISTERS

INOX. A-2

CÓDIGO CODE CODE	MEDIDA SIZE MEASURE			PRECIO TARIFA PRICE LIST PRIX TARIFS
	MxL (m.m.)			€/BLISTER
B933A205016	5x16	4	20	2,09
B933A205020	5x20	4	20	2,09
B933A205025	5x25	4	20	2,09
B933A205030	5x30	4	20	2,09
B933A205040	5x40	4	20	2,09
B933A206016	6x16	4	20	2,09
B933A206020	6x20	4	20	2,09
B933A206025	6x25	4	20	2,09
B933A206030	6x30	4	20	2,09
B933A206040	6x40	4	20	2,09
B933A208020	8x20	4	20	2,09
B933A208025	8x25	4	20	2,09
B933A208030	8x30	4	20	2,09
B933A208040	8x40	2	20	2,09
B933A208050	8x50	2	20	2,09
B933A208060	8x60	2	20	2,09

**PEDIDO MÍNIMO 1 EMBALAJE / MINIMUM ORDER 1 PACKAGING
COMMANDE MINIMALE 1 EMBALLAGE / MINDESTBESTELLMENGE 1 VERPACKUNG**

MALETÍN TLLO. DIN 933 INOXIDABLE A-2

SS. AISI 304 SCREW DIN 933 BRIEFCASE
MALLETTE AVEC VIS DIN 933 EN ACIER INOX. A-2
HANDKOFFER AUS SCHRAUBE DIN 933 - EDELSTAHL A-2

**INOX
A2**



MEDIDA SIZE / MESURE m.m.	CANTIDAD QUANTITY QUANTITÉ	MEDIDA SIZE / MESURE m.m.	CANTIDAD QUANTITY QUANTITÉ
M-4x16	50	M-8x25	15
M-4x20	30	M-8x30	10
M-4x25	25	M-8x40	8
M-5x16	40	M-8x60	6
M-5x20	30	M-8x80	5
M-5x25	25	M-10x20	8
M-6x16	30	M-10x30	6
M-6x20	30	M-10x40	5
M-6x25	25	M-10x70	4
M-6x30	20	M-10x100	2
M-8x20	15		

MALETÍN TLLO. DIN 933 INOXIDABLE A-4

SS. AISI 316 SCREW DIN 933 BRIEFCASE
MALLETTE AVEC VIS DIN 933 EN ACIER INOX. A-4
HANDKOFFER AUS SCHRAUBE DIN 933 - EDELSTAHL A-4

**INOX
A4**



MEDIDA SIZE / MESURE m.m.	CANTIDAD QUANTITY QUANTITÉ	MEDIDA SIZE / MESURE m.m.	CANTIDAD QUANTITY QUANTITÉ
M-4x16	50	M-8x25	15
M-4x20	30	M-8x30	10
M-4x25	25	M-8x40	8
M-5x16	40	M-8x60	6
M-5x20	30	M-8x80	5
M-5x25	25	M-10x20	8
M-6x16	30	M-10x30	6
M-6x20	30	M-10x40	5
M-6x25	25	M-10x70	4
M-6x30	20	M-10x100	2
M-8x20	15		

CÓDIGO CODE / CODE	DESCRIPCIÓN DESCRIPTION / DESCRIPTION
M9332	MALETÍN TORNILLO DIN 933 INOX. A-2

PRECIO TARIFA / PRICE LIST	PRECIO TARIFA / PRICE LIST
€/UNIDAD	€/100 U.
85,94	8.594,00

CÓDIGO CODE / CODE	DESCRIPCIÓN DESCRIPTION / DESCRIPTION
M9334	MALETÍN TORNILLO DIN 933 INOX. A-4

PRECIO TARIFA / PRICE LIST	PRECIO TARIFA / PRICE LIST
€/UNIDAD	€/100 U.
137,50	13.750,00

TORNILLO DIN 931 INOXIDABLE A-2

HEXAGON HEAD SCREW DIN 931 - STAINLESS STEEL AISI 304
VIS TÊTE HEXAGONALE DIN 931 EN ACIER INOX. A-2
SECHSKANTSCHRAUBE DIN 931 - EDELSTAHL A-2

**INOX
A2**

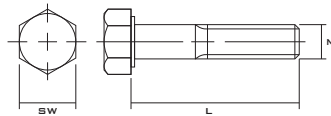

CAJA

COD.: 931A2	PRECIO TARIFA / PRICE LIST / PRIX TARIFS
	€/100 U.

m.m.	M6 (SW-10)	M8 (SW-13)	M10 (SW-17)	M12 (SW-19)	M14 (SW-22)	M16 (SW-24)	M18 (SW-27)	M20 (SW-30)
35	38,53	71,65						
40	42,54	78,14	126,57					
45	46,87	85,32	138,94	191,27				
50	50,43	88,88	145,59	201,75	374,00	475,02		
55	59,01	100,12	161,77	220,78	387,33	475,02		
60	62,57	103,98	171,30	232,21	408,25	422,53		
70	78,99	127,15	190,32	261,71	459,63	480,59	899,29	823,18
80	95,16	154,88	222,68	308,34	513,89	545,30	987,80	925,00
90	114,19	181,48	241,71	342,59	591,93	647,11	1.077,27	1.018,26
100	158,34	209,35	295,01	374,00	670,91	703,27	1.189,56	1.113,42
110	211,12	236,01	371,15	420,63	727,99	784,15	1.303,75	1.184,81
120	224,32	271,82	423,48	486,29	764,18	820,31	1.456,97	1.334,20
130		309,29	479,64	566,22	986,99	899,29	1.732,00	1.498,85
140		448,63	529,12	622,38	1.060,88	1.003,98	2.533,44	1.689,17
150		527,80	578,60	689,94	1.182,27	1.080,12	2.770,95	1.831,91

TORNILLO ISO 7380 INOXIDABLE A-2

HEXAGON SOCKET PANHEAD SCREW ISO 7380 STAINLESS STEEL AISI 304
 VIS FILETAGE MÉTRIQUE TÊTE BOMBÉE À SIX PANS CREUX ISO 7380 EN ACIER INOX. A-2
 RUNDKOPFSCHRAUBE MIT INNENSECHSKANT ISO 7380 - EDELSTAHL A-2

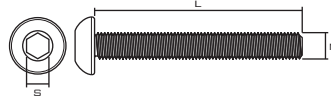

CAJA 

INOX. A-2

COD.: 7380A2

PRECIO TARIFA / PRICE LIST / PRIX TARIFS **€/100 u.**

m.m.	M3 (S-2)	M4 (S-2,5)	M5 (S-3)	M6 (S-4)	M8 (S-5)	M10 (S-6)
10	13,33	19,03	24,75	39,98	82,79	
12	14,28	19,03	25,70	39,98	82,79	
16	15,23	22,85	29,50	37,10	71,38	
20	17,13	24,75	33,30	41,88	76,14	151,32
25	22,85	28,53	37,10	46,63	86,61	134,19
30	26,65	32,35	42,83	51,38	98,01	147,49
35		36,15	49,48	59,01	108,49	161,77
40		39,03	58,03	63,76	117,07	177,00
45			71,38	78,99	125,62	190,32
50			74,24	85,66	136,36	205,55
60				99,91	153,22	256,93

TORNILLO DIN 7991 INOXIDABLE A-2

HEXAGON SOCKET COUNTERSUNK HEAD SCREW STAINLESS STEEL AISI 304
 VIS FILETAGE MÉTRIQUE DIN 7991 EN ACIER INOX. A-2
 SENNKOPFSCHRAUBE MIT INNENSECHSKANT DIN 7991 - EDELSTAHL A-2

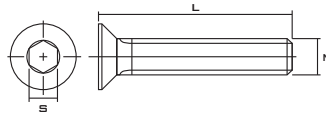

CAJA 

INOX. A-2

COD.: 7991A2

PRECIO TARIFA / PRICE LIST / PRIX TARIFS **€/100 u.**

m.m.	M3 (S-2)	M4 (S-2,5)	M5 (S-3)	M6 (S-4)	M8 (S-5)	M10 (S-6)	M12 (S-8)
6	8,58	9,53	14,86				
8	8,58	11,43	14,15				
10	9,05	12,38	14,15	16,78			
12	9,53	12,88	14,94	16,65	33,15		
16	10,95	13,30	16,52	17,65	33,88		
20	12,38	14,04	20,48	20,16	39,74	64,60	146,54
25	15,23	17,21	23,86	23,80	42,36	67,98	158,92
30	18,08	19,03	29,98	28,32	46,58	76,85	163,88
35		22,35	34,20	31,88	51,78	87,61	167,50
40		25,70	45,39	35,31	61,52	97,06	179,37
45			49,48	45,79	75,32	108,25	195,07
50				49,77	83,81	119,52	206,90
60				70,57	107,46	155,81	272,08
70					137,99	190,32	327,37
80						244,90	385,43

TORNILLO DIN 603 INOXIDABLE A-2

MUSHROOM HEAD SQUARE NECK BOLT DIN 603 - STAINLESS STEEL AISI 304
BOULON TÊTE BOMBÉE TIGE À COLLET CARRÉ DIN 603 EN ACIER INOX. A-2
FLACHRUNDKOPF-BOLZENSCHAFT MIT VIERKANT DIN 603 - EDELSTAHL A-2

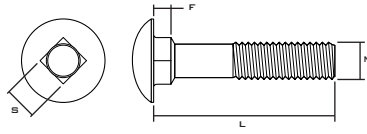

CAJA

INOX. A-2

COD.: 603A2

PRECIO TARIFA / PRICE LIST / PRIX TARIFS **€/100 u.**

m.m.	M5	M6	M8	M10
16	25,70	39,98	62,81	
20	26,65	42,83	66,61	
25	29,50	46,63	73,29	111,34
30	34,25	51,38	78,99	121,82
35	52,33	57,11	97,06	129,42
40	52,33	61,86	100,86	137,04
45		67,56	104,69	152,27
50		72,33	111,34	166,55
60		86,61	131,32	186,52
70		98,96	157,02	225,53
80		120,87	183,67	264,56
90				304,51
100				347,35

INSTALACIÓN

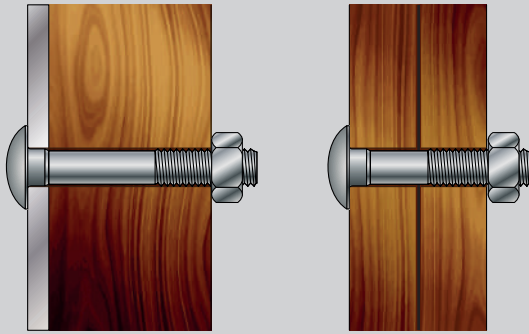

INFORMACIÓN TÉCNICA / TECHNICAL DATA

	S _{min}	F _{max}
M5	4,52	4,10
M6	5,52	4,60
M8	7,42	5,60
M10	9,42	6,60
M12	11,30	8,75

TORNILLO DIN 7985 INOXIDABLE A-2

SCREW DIN 7985 STAINLESS STEEL AISI 304
VIS FILETAGE MÉTRIQUE DIN 7985 EN ACIER INOX. A-2
ZYLINDERKOPFSCHRAUBE DIN 7985 - EDELSTAHL A-2

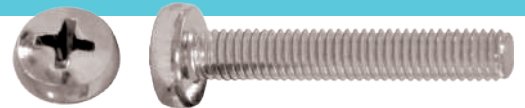
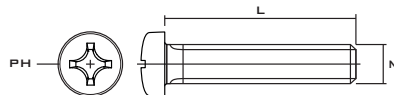

CAJA

INOX. A-2

COD.: 7985A2

PRECIO TARIFA / PRICE LIST / PRIX TARIFS **€/100 u.**

m.m.	M3 (PH-1)	M4 (PH-2)	M5 (PH-2)	M6 (PH-3)
6	5,09	8,18		
8	5,33	8,58	15,23	21,88
10	5,57	8,95	16,65	23,30
12	6,10	10,00	17,60	26,18
16	6,41	11,19	19,98	28,55
18	7,05	13,80	22,83	31,40
20	8,52	16,18	26,65	35,68
25	9,53	18,74	30,45	39,00
30		22,83	36,15	42,59
35			45,68	56,16
40			45,68	56,16

TORNILLO DIN 84 INOXIDABLE A-2

SCREW DIN 84 STAINLESS STEEL AISI 304
 VIS FILETAGE MÉTRIQUE DIN 84 EN ACIER INOX. A-2
 ZYLINDERKOPFSCHRAUBE DIN 84 - EDELSTAHL A-2

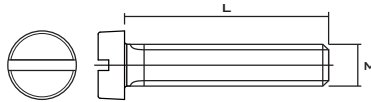
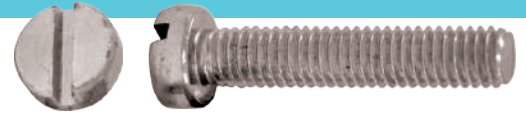

CAJA 

INOX. A-2



COD.: 84A2

PRECIO TARIFA / PRICE LIST / PRIX TARIFS **€/100 u.**

m.m.	M3	M4	M5	M6	M8
6	6,39	7,60			
8	6,39	7,60	15,23	20,93	
10	5,91	8,00	13,80	17,36	48,53
12	6,57	9,29	14,28	18,60	55,21
16	6,86	9,05	16,18	21,40	58,06
20	7,60	10,48	17,60	23,51	58,06
25	8,58	12,38	19,98	24,75	61,86
30	10,24	14,28	22,83	28,16	70,41
35	16,18	19,03	25,70	34,91	76,14
40	20,93	20,93	27,79	39,00	81,84
45		33,30	29,98	45,68	90,41
50		39,00	36,15	51,38	98,01



AUTOSERVICIO

INOX. A-2

CÓDIGO CODE CODE	MEDIDA SIZE MESURE			PRECIO TARIFA PRICE LIST PRIX TARIFS
	MxL (m.m.)			€/BOLSA
BF84A204010	4x10	100	12	8,27
BF84A204016	4x16	100	12	8,29
BF84A204020	4x20	75	12	6,87
BF84A205010	5x10	100	12	10,95
BF84A205016	5x16	75	12	11,22
BF84A205020	5x20	75	12	11,22
BF84A205025	5x25	75	12	12,76
BF84A205030	5x30	75	12	15,90
BF84A206016	6x16	75	12	15,74
BF84A206020	6x20	50	12	11,75
BF84A206025	6x25	50	12	13,38
BF84A206030	6x30	50	12	15,96

BLISTERS

INOX. A-2

CÓDIGO CODE CODE	MEDIDA SIZE MESURE			PRECIO TARIFA PRICE LIST PRIX TARIFS
	MxL (m.m.)			€/BLISTER
BB4A203016	3x16	10	20	2,09
BB4A203020	3x20	10	20	2,09
BB4A203025	3x25	10	20	2,09
BB4A203030	3x30	10	20	2,09
BB4A204016	4x16	6	20	2,09
BB4A204020	4x20	6	20	2,09
BB4A204025	4x25	6	20	2,09
BB4A204030	4x30	6	20	2,09
BB4A205020	5x20	6	20	2,09
BB4A205025	5x25	6	20	2,09
BB4A205030	5x30	6	20	2,09
BB4A205040	5x40	6	20	2,09
BB4A206020	6x20	6	20	2,09
BB4A206025	6x25	6	20	2,09
BB4A206030	6x30	6	20	2,09
BB4A206040	6x40	4	20	2,09

**PEDIDO MÍNIMO 1 EMBALAJE / MINIMUM ORDER 1 PACKAGING
 COMMANDE MINIMALE 1 EMBALLAGE / MINDESTBESTELLMENGE 1 VERPACKUNG**

TORNILLO DIN 965 INOXIDABLE A-2

SCREW DIN 965 STAINLESS STEEL AISI 304
VIS FILETAGE MÉTRIQUE DIN 965 EN ACIER INOX. A-2
SENKKOPFSCHRAUBE DIN 965 - EDELSTAHL A-2

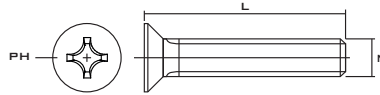

CAJA

INOX. A-2

COD.: 965A2

PRECIO TARIFA / PRICE LIST / PRIX TARIFS **€/100 u.**

m.m.	M3 (PH-1)	M4 (PH-2)	M5 (PH-2)	M6 (PH-3)	M8 (PH-4)
6	5,09	8,18			
8	5,33	8,18			
10	5,57	8,58	15,23	21,88	
12	6,10	8,95	16,65	23,30	78,51
16	6,41	10,00	17,60	26,18	85,64
20	7,05	11,19	19,98	28,55	92,79
25	8,52	13,80	22,83	31,40	99,91
30	9,53	16,18	26,65	35,68	110,39
35		18,74	30,45	39,00	133,24
40		22,83	36,15	42,59	142,74
45			45,68	56,16	171,30
50			45,68	56,16	171,30

AUTOSERVICIO

INOX. A-2

CÓDIGO CODE CODE	MEDIDA SIZE MESURE			PRECIO TARIFA PRICE LIST PRIX TARIFS
	MxL (m.m.)			€/BOLSA
BF965A204010	4x10	100	12	4,45
BF965A204016	4x16	100	12	6,29
BF965A204020	4x20	75	12	6,16
BF965A205010	5x10	100	12	7,55
BF965A205016	5x16	75	12	6,57
BF965A205020	5x20	75	12	8,51
BF965A205025	5x25	75	12	9,43

AUTOSERVICIO

INOX. A-2

CÓDIGO CODE CODE	MEDIDA SIZE MESURE			PRECIO TARIFA PRICE LIST PRIX TARIFS
	MxL (m.m.)			€/BOLSA
BF965A206010	6x10	75	12	9,37
BF965A206016	6x16	75	12	10,86
BF965A206020	6x20	50	12	7,75
BF965A206025	6x25	50	12	8,94
BF965A206030	6x30	50	12	9,07

**PEDIDO MÍNIMO 1 EMBALAJE / MINIMUM ORDER 1 PACKAGING
COMMANDE MINIMALE 1 EMBALLAGE / MINDESTBESTELLMENGE 1 VERPACKUNG**

TORNILLO DIN 963 INOXIDABLE A-2

SCREW DIN 963 STAINLESS STEEL AISI 304
VIS FILETAGE MÉTRIQUE DIN 963 EN ACIER INOX. A-2
SENKKOPFSCHRAUBE DIN 963 - EDELSTAHL A-2

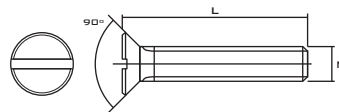

BLISTERS

INOX. A-2

CÓDIGO CODE CODE	MEDIDA SIZE MESURE			PRECIO TARIFA PRICE LIST PRIX TARIFS
	MxL (m.m.)			€/BLISTER
B963A203016	3x16	10	20	2,09
B963A203020	3x20	10	20	2,09
B963A203025	3x25	10	20	2,09
B963A203030	3x30	10	20	2,09
B963A204016	4x16	6	20	2,09
B963A204020	4x20	6	20	2,09
B963A204025	4x25	6	20	2,09
B963A204030	4x30	6	20	2,09

BLISTERS

INOX. A-2

CÓDIGO CODE CODE	MEDIDA SIZE MESURE			PRECIO TARIFA PRICE LIST PRIX TARIFS
	MxL (m.m.)			€/BLISTER
B963A205020	5x20	6	20	2,09
B963A205025	5x25	6	20	2,09
B963A205030	5x30	6	20	2,09
B963A205040	5x40	6	20	2,09
B963A206020	6x20	6	20	2,09
B963A206025	6x25	6	20	2,09
B963A206030	6x30	6	20	2,09
B963A206040	6x40	4	20	2,09

**PEDIDO MÍNIMO 1 EMBALAJE / MINIMUM ORDER 1 PACKAGING
COMMANDE MINIMALE 1 EMBALLAGE / MINDESTBESTELLMENGE 1 VERPACKUNG**

VARILLAS ROSCADAS, TUERCAS Y ARANDELAS INOXIDABLES A-2

THREADED RODS, NUTS AND WASHERS - STAINLESS STEEL AISI 304
 TIGES FILETÉES, ÉCROUS ET RONDELLES - INOX. A-2
 GEWINDESTANGEN, MUTTERN UND SCHEIBEN - EDELSTAHL A-2

CAJA

INOX. A-2

PRECIO TARIFA / PRICE LIST / PRIX TARIFS €/100 U.



MÉTRICA METRICS MÉTRIQUE	DIN 934 INOX A-2 / AISI 304 Cod.: 934A2	DIN 985 INOX A-2 / AISI 304 Cod.: 985A2	DIN 6923 INOX A-2 / AISI 304 Cod.: 6923A2	DIN 1587 INOX A-2 / AISI 304 Cod.: 1587A2	DIN 315 INOX A-2 / AISI 304 Cod.: 315A2
M 3	3,77	7,52			62,81
M 4	4,01	7,86	14,74	48,53	62,81
M 5	4,54	8,37	15,60	40,14	65,66
M 6	7,49	11,08	17,20	42,44	71,38
M 8	15,20	23,01	42,14	76,14	132,27
M10	33,91	50,25	83,27	154,86	209,35
M12	49,72	74,53	116,14	228,41	515,13
M14	71,46	133,24			1.673,13
M16	100,28	166,78			2.406,77
M18	159,50	593,25			
M20	209,43	612,25			
M22	295,57	1.662,57			
M24	384,24	2.269,54			
M27	1.228,72				
M30	1.384,95				

CAJA

INOX. A-2

PRECIO TARIFA / PRICE LIST / PRIX TARIFS €/100 U.



MÉTRICA METRICS MÉTRIQUE	DIN 975 INOX A-2 / AISI 304 Cod.: 975A2	DIN 125 INOX A-2 / AISI 304 Cod.: 125A2	DIN 9021 INOX A-2 / AISI 304 Cod.: 9021A2	DIN 127 INOX A-2 / AISI 304 Cod.: 127A2
M 3				
M 4	645,54	1,19	2,08	1,50
M 5	587,44	1,48	3,85	2,06
M 6	758,75	2,77	6,94	3,48
M 8	1.354,42	4,78	14,70	5,70
M10	2.082,78	8,95	30,82	8,58
M12	3.017,60	16,18	53,10	13,72
M14	4.305,63	26,26	98,59	21,88
M16	5.611,94	28,61	119,07	31,75
M18	7.585,10	41,83	236,45	38,21
M20	9.025,38	44,26	268,12	54,05
M22	11.674,53	52,33		
M24	13.416,27	91,36		
M27	18.084,26	159,18		
M30	25.666,31	225,90		

LLAVE / KEY / CLÉ - SW

	DIN 934	DIN 985	DIN 6923	DIN 1587		DIN 934	DIN 985	DIN 6923	DIN 1587
M 3	5,5	5,5	5,5	5,5	M18	27	27	-	27
M 4	7	7	7	7	M20	30	30	30	30
M 5	8	8	8	8	M22	32	32	-	32
M 6	10	10	10	10	M24	36	36	36	36
M 8	13	13	13	13	M27	41	41	-	41
M10	17	17	15	17	M30	46	46	-	46
M12	19	19	18	19	M33	50	50	-	50
M14	22	22	21	22	M36	55	55	-	55
M16	24	24	24	24	M39	60	60	-	60

VARILLAS ROSCADAS, TUERCAS Y ARANDELAS INOXIDABLES A-2

THREADED RODS, NUTS AND WASHERS - STAINLESS STEEL AISI 304
 TIGES FILETÉES, ÉCROUS ET RONDELLES - INOX. A-2
 GEWINDESTANGEN, MUTTERN UND SCHEIBEN - EDELSTAHL A-2





AUTOSERVICIO

PRECIO TARIFA / PRICE LIST / PRIX TARIFS **€/BOLSA**



EMBALAJE / PACKAGING / EMBALLAGE **X12** 

INOX. A-2

				
MÉTRICA METRICS MÉTRIQUE	DIN 934 INOX A-2 / AISI 304 Cod.: BF934A2	DIN 985 INOX A-2 / AISI 304 Cod.: BF985A2	DIN 125 INOX A-2 / AISI 304 Cod.: BF125A2	DIN 9021 INOX A-2 / AISI 304 Cod.: BF9021A2
M 4	3,97	6,39	3,38	3,92
M 5	5,09	6,63	3,18	4,26
M 6	7,65	8,95	3,49	7,17
M 8	7,37	8,68	4,26	7,89
M10	9,22	9,91	4,96	8,24
M12	9,54	8,38	7,54	5,63





BLISTERS

PRECIO TARIFA / PRICE LIST / PRIX TARIFS **€/BLISTER**



EMBALAJE / PACKAGING / EMBALLAGE **X20** 

INOX. A-2

				
MÉTRICA METRICS MÉTRIQUE	DIN 934 INOX A-2 / AISI 304 Cod.: B934A2	DIN 985 INOX A-2 / AISI 304 Cod.: B985A2	DIN 125 INOX A-2 / AISI 304 Cod.: B125A2	DIN 9021 INOX A-2 / AISI 304 Cod.: B9021A2
M 3	1,60	1,60	1,60	1,60
M 4	1,60	1,60	1,60	1,60
M 5	1,60	1,60	1,60	1,60
M 6	1,60	1,60	1,60	1,60
M 8	1,60	1,60	1,60	1,60
M10	1,60	1,60	1,60	1,60
M12	1,60	1,60	1,60	1,60

PEDIDO MÍNIMO 1 EMBALAJE / MINIMUM ORDER 1 PACKAGING
COMMANDE MINIMALE 1 EMBALLAGE / MINDESTBESTELLMENGE 1 VERPACKUNG

MALETÍN DE ARANDELAS INOXIDABLES A-2

STAINLESS STEEL AISI 304 WASHERS BRIEFCASE
 MALLETTTE AVEC RONDELLES EN ACIER INOX. A-2
 HANDKOFFER AUS SCHEIBEN EDELSTAHL A-2

**INOX
A2**



MEDIDAS INCLUIDAS EN EL MALETÍN
 MEASURES INCLUDED IN THE BRIEFCASE / MESURES INCLUSES DANS LE MALLETTTE

DIN 125 A2		DIN 9021 A2		DIN 127 A2	
MEDIDA SIZE / MESURE m.m.	CANTIDAD QUANTITY QUANTITÉ	MEDIDA SIZE / MESURE m.m.	CANTIDAD QUANTITY QUANTITÉ	MEDIDA SIZE / MESURE m.m.	CANTIDAD QUANTITY QUANTITÉ
M 4	100	M 4	100	M 4	100
M 5	100	M 5	100	M 5	100
M 6	100	M 6	100	M 6	100
M 8	100	M 8	100	M 8	100
M10	50	M10	50	M10	50
M12	50	M12	50	M12	50

CÓDIGO
CODE / CODE

DESCRIPCIÓN
DESCRIPTION / DESCRIPTION

MA2 MALETÍN DE ARANDELAS SURTIDAS INOXIDABLES A-2

PRECIO TARIFA / PRICE LIST

PRECIO TARIFA / PRICE LIST

€/UNIDAD

€/100 U.

85,94

8.594,00

MALETÍN DE TUERCAS INOXIDABLES A-2

 STAINLESS STEEL AISI 304 NUTS BRIEFCASE
 MALLETTE DE ÉCROUS EN ACIER INOX. A-2
 HANDKOFFER AUS MUTTERN EDELSTAHL A-2

**INOX
A2**

 MEDIDAS INCLUIDAS EN EL MALETÍN
 MEASURES INCLUDED IN THE BRIEFCASE / MESURES INCLUSES DANS LE MALLETTE

DIN 934 A-2		DIN 985 A-2		DIN 6923 A-2	
MEDIDA SIZE / MESURE m.m.	CANTIDAD QUANTITY QUANTITÉ	MEDIDA SIZE / MESURE m.m.	CANTIDAD QUANTITY QUANTITÉ	MEDIDA SIZE / MESURE m.m.	CANTIDAD QUANTITY QUANTITÉ
M 3	100	M 4	100	M 6	50
M 4	100	M 5	100	M 8	25
M 5	100	M 6	50	M10	12
M 6	50	M 8	25	M12	5
M 8	25	M10	12		
M10	12	M12	7		
M12	7				
M14	5				
M16	5				
M20	5				

CÓDIGO
 CODE / CODE

DESCRIPCIÓN
 DESCRIPTION / DESCRIPTION

MTUA2

MALETÍN DE TUERCAS SURTIDAS INOX. A-2

PRECIO TARIFA / PRICE LIST
PRECIO TARIFA / PRICE LIST
€/UNIDAD
€/100 U.
85,94
8.594,00
MALETÍN DE ARANDELAS INOXIDABLES A-4

 STAINLESS STEEL AISI 316 WASHERS BRIEFCASE
 MALLETTE AVEC RONDELLES EN ACIER INOX. A-4
 HANDKOFFER AUS SCHEIBEN EDELSTAHL A-4

**INOX
A4**

 MEDIDAS INCLUIDAS EN EL MALETÍN
 MEASURES INCLUDED IN THE BRIEFCASE / MESURES INCLUSES DANS LE MALLETTE

DIN 125 A4		DIN 9021 A4		DIN 127 A4	
MEDIDA SIZE / MESURE m.m.	CANTIDAD QUANTITY QUANTITÉ	MEDIDA SIZE / MESURE m.m.	CANTIDAD QUANTITY QUANTITÉ	MEDIDA SIZE / MESURE m.m.	CANTIDAD QUANTITY QUANTITÉ
M 4	100	M 4	100	M 4	100
M 5	100	M 5	100	M 5	100
M 6	100	M 6	100	M 6	100
M 8	100	M 8	100	M 8	100
M10	50	M10	50	M10	50
M12	50	M12	50	M12	50

CÓDIGO
 CODE / CODE

DESCRIPCIÓN
 DESCRIPTION / DESCRIPTION

MA4

MALETÍN DE ARANDELAS SURTIDAS INOXIDABLES A-4

PRECIO TARIFA / PRICE LIST
PRECIO TARIFA / PRICE LIST
€/UNIDAD
€/100 U.
137,50
13.750,00
MALETÍN DE TUERCAS INOXIDABLES A-4

 STAINLESS STEEL AISI 316 NUTS BRIEFCASE
 MALLETTE DE ÉCROUS EN ACIER INOX. A-4
 HANDKOFFER AUS MUTTERN EDELSTAHL A-4

**INOX
A4**

 MEDIDAS INCLUIDAS EN EL MALETÍN
 MEASURES INCLUDED IN THE BRIEFCASE / MESURES INCLUSES DANS LE MALLETTE

DIN 934 A-4		DIN 985 A-4		DIN 6923 A-4	
MEDIDA SIZE / MESURE m.m.	CANTIDAD QUANTITY QUANTITÉ	MEDIDA SIZE / MESURE m.m.	CANTIDAD QUANTITY QUANTITÉ	MEDIDA SIZE / MESURE m.m.	CANTIDAD QUANTITY QUANTITÉ
M 3	100	M 4	100	M 6	50
M 4	100	M 5	100	M 8	25
M 5	100	M 6	50	M10	12
M 6	50	M 8	25	M12	5
M 8	25	M10	12		
M10	12	M12	7		
M12	7				
M14	5				
M16	5				
M20	5				

CÓDIGO
 CODE / CODE

DESCRIPCIÓN
 DESCRIPTION / DESCRIPTION

MTUA4

MALETÍN DE TUERCAS SURTIDAS INOX. A-4

PRECIO TARIFA / PRICE LIST
PRECIO TARIFA / PRICE LIST
€/UNIDAD
€/100 U.
137,50
13.750,00

TORNILLO DIN 7981 INOXIDABLE A-2

PAN HEAD SCREW DIN 7981 STAINLESS STEEL AISI 304
VIS À TÔLE TÊTE CYLINDRIQUE DIN 7981 EN ACIER INOX. A-2
ZYLINDERKOPF-BLECHSCHRAUBE DIN 7981 - EDELSTAHL A-2



CAJA

INOX. A-2

COD.: 7981A2

PRECIO TARIFA / PRICE LIST / PRIX TARIFS **€/100 u.**

m.m.	Ø2,9 (PH-1)	Ø3,5 (PH-2)	Ø3,9 (PH-2)	Ø4,2 (PH-2)	Ø4,8 (PH-2)	Ø5,5 (PH-3)	Ø6,3 (PH-3)
6,5	4,86	5,46					
9,5	5,04	5,91	6,94	7,60	12,09		
13	5,46	6,04	7,60	8,18	12,93	17,31	
16	5,75	6,41	8,00	8,60	13,70	18,74	36,39
19	5,99	7,23	8,58	9,53	14,57	19,98	37,50
22	6,86	7,89	9,29	10,24	16,52	23,30	42,83
25	7,52	8,95	9,90	10,71	17,71	24,17	45,21
32		10,27	11,14	13,33	20,45	27,21	46,16
38		12,14	15,70	16,94	23,83	30,45	56,82
45				21,88	28,55	36,15	66,61
50				26,65	31,40	40,93	69,85
60					50,19	71,12	126,04
70					59,96	88,33	161,72

AUTOSERVICIO

INOX. A-2

CÓDIGO CODE CODE	MEDIDA SIZE MESURE	100	12	PRECIO TARIFA PRICE LIST PRIX TARIFS
	ØxL (m.m.)			€/BOLSA
BF7981A23509	3,5x9,5	100	12	4,19
BF7981A23513	3,5x13	100	12	5,27
BF7981A23516	3,5x16	100	12	5,73
BF7981A23519	3,5x19	100	12	7,04
BF7981A23525	3,5x25	100	12	6,90
BF7981A23919	3,9x19	100	12	8,44
BF7981A23925	3,9x25	100	12	9,26
BF7981A24216	4,2x16	100	12	7,82
BF7981A24219	4,2x19	100	12	8,17
BF7981A24225	4,2x25	100	12	9,07
BF7981A24232	4,2x32	100	12	12,22
BF7981A24819	4,8x19	100	12	11,40
BF7981A24825	4,8x25	100	12	12,45
BF7981A24832	4,8x32	100	12	14,51
BF7981A24838	4,8x38	50	12	7,83
BF7981A25532	5,5x32	50	12	11,24
BF7981A25538	5,5x38	50	12	11,71

MALETÍN TORNILLOS DIN 7981 INOXIDABLE A-2

STAINLESS STEEL AISI 304 SCREW DIN 7981 BRIEFCASE
MALLETTE AVEC VIS DIN 7981 EN ACIER INOX. A-2
HANDKOFFER ZYLINDERKOPF-BLECHSCHRAUBE DIN 7981 - ED. A-2



MEDIDA SIZE / MESURE m.m.	CANTIDAD QUANTITY QUANTITÉ	MEDIDA SIZE / MESURE m.m.	CANTIDAD QUANTITY QUANTITÉ
3,5x6,5	200	4,8x13	100
3,5x9,5	200	4,8x16	100
3,5x13	200	4,8x19	50
3,9x13	200	4,8x25	50
3,9x16	150	4,8x32	50
3,9x19	100	5,5x19	40
3,9x25	100	5,5x25	40
4,2x13	100	5,5x38	40
4,2x16	100	5,5x50	30
4,2x19	100		
4,2x25	50		

BLISTERS

INOX. A-2

CÓDIGO CODE CODE	MEDIDA SIZE MESURE	20	20	PRECIO TARIFA PRICE LIST PRIX TARIFS
	ØxL (m.m.)			€/BLISTER
B7981A23513	3,5x13	20	20	2,89
B7981A23516	3,5x16	20	20	2,89
B7981A23519	3,5x19	20	20	2,89
B7981A23913	3,9x13	20	20	2,89
B7981A23916	3,9x16	20	20	2,89
B7981A23919	3,9x19	20	20	2,89
B7981A23925	3,9x25	20	20	2,89
B7981A24225	4,2x25	10	20	2,89
B7981A24232	4,2x32	10	20	2,89
B7981A24238	4,2x38	10	20	2,89
B7981A24250	4,2x50	8	20	2,89
B7981A24825	4,8x25	10	20	2,89
B7981A24832	4,8x32	10	20	2,89
B7981A24838	4,8x38	10	20	2,89
B7981A24850	4,8x50	8	20	2,89

CÓDIGO Code / CODE	DESCRIPCIÓN DESCRIPTION / DESCRIPTION
M7981A2	MALETÍN TORNILLO DIN 7981 INOX. A-2

PRECIO TARIFA / PRICE LIST	PRECIO TARIFA / PRICE LIST
€/UNIDAD	€/100 u.
166,67	16.667,00

**PEDIDO MÍNIMO 1 EMBALAJE
MINIMUM ORDER 1 PACKAGING**

TORNILLO DIN 7982 INOXIDABLE A-2

FLAT CSK HEAD SCREW DIN 7982 STAINLESS STEEL AISI 304
VIS À TOLE TÊTE FRAISÉE DIN 7982 EN ACIER INOX. A-2
SENKKOPF-BLECHSCHRAUBE DIN 7982 - EDELSTAHL A-2

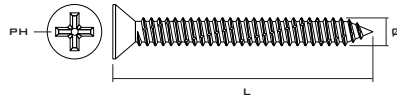
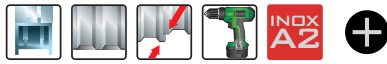

CAJA

INOX. A-2

COD.: 7982A2

PRECIO TARIFA / PRICE LIST / PRIX TARIFS **€/100 u.**

m.m.	Ø2,9 (PH-1)	Ø3,5 (PH-2)	Ø3,9 (PH-2)	Ø4,2 (PH-2)	Ø4,8 (PH-2)	Ø5,5 (PH-3)	Ø6,3 (PH-3)
6,5	4,86	5,46					
9,5	5,04	5,91	6,94	7,60	12,09		
13	5,46	6,04	7,60	8,18	12,93	17,31	
16	5,75	6,41	8,00	8,60	13,70	18,74	36,39
19	5,99	7,23	8,58	9,53	14,57	19,98	37,50
22	6,86	7,89	9,29	10,24	16,52	23,30	42,83
25	7,52	8,95	9,90	10,71	17,71	24,17	45,21
32		10,27	11,14	13,33	20,45	27,21	46,16
38		12,14	15,70	16,94	23,83	30,45	56,82
45				21,88	28,55	36,15	66,61
50				26,65	31,40	40,93	69,85
60					50,19	71,12	126,04
70					59,96	88,33	161,72

AUTOSERVICIO

INOX. A-2

CÓDIGO / CODE / CODE MEDIDA / SIZE / MEASURE PRECIO TARIFA / PRICE LIST / PRIX TARIFS

ØxL (m.m.)

€/BOLSA

CÓDIGO / CODE / CODE	MEDIDA / SIZE / MEASURE	100	12	PRECIO TARIFA / PRICE LIST / PRIX TARIFS
BF7982A23509	3,5x9,5	100	12	3,63
BF7982A23513	3,5x13	100	12	4,39
BF7982A23516	3,5x16	100	12	5,25
BF7982A23519	3,5x19	100	12	5,42
BF7982A23525	3,5x25	100	12	7,50
BF7982A23919	3,9x19	100	12	5,86
BF7982A23925	3,9x25	100	12	7,22
BF7982A24216	4,2x16	100	12	6,16
BF7982A24219	4,2x19	100	12	7,06
BF7982A24225	4,2x25	100	12	9,52
BF7982A24232	4,2x32	100	12	10,43
BF7982A24819	4,8x19	100	12	9,33
BF7982A24825	4,8x25	100	12	11,91
BF7982A24832	4,8x32	100	12	15,05
BF7982A24838	4,8x38	50	12	8,16
BF7982A25532	5,5x32	50	12	9,60
BF7982A25538	5,5x38	50	12	10,76

BLISTERS

INOX. A-2

CÓDIGO / CODE / CODE MEDIDA / SIZE / MEASURE PRECIO TARIFA / PRICE LIST / PRIX TARIFS

ØxL (m.m.)

€/BLISTER

CÓDIGO / CODE / CODE	MEDIDA / SIZE / MEASURE	20	20	PRECIO TARIFA / PRICE LIST / PRIX TARIFS
B7982A23513	3,5x13	20	20	2,89
B7982A23516	3,5x16	20	20	2,89
B7982A23519	3,5x19	20	20	2,89
B7982A23913	3,9x13	20	20	2,89
B7982A23916	3,9x16	20	20	2,89
B7982A23919	3,9x19	20	20	2,89
B7982A23925	3,9x25	20	20	2,89
B7982A24225	4,2x25	10	20	2,89
B7982A24232	4,2x32	10	20	2,89
B7982A24238	4,2x38	10	20	2,89
B7982A24250	4,2x50	8	20	2,89
B7982A24825	4,8x25	10	20	2,89
B7982A24832	4,8x32	10	20	2,89
B7982A24838	4,8x38	10	20	2,89
B7982A24850	4,8x50	8	20	2,89

MALETÍN TORNILLOS DIN 7982 INOXIDABLE A-2

STAINLESS STEEL AISI 304 SCREW DIN 7982 BRIEFCASE
MALLETTE AVEC VIS DIN 7982 EN ACIER INOX. A-2
HANDKOFFER SENKKOPF-BLECHSCHRAUBE DIN 7982 - ED. A-2



MEDIDA / SIZE / MEASURE / m.m.	CANTIDAD / QUANTITY / QUANTITÉ	MEDIDA / SIZE / MEASURE / m.m.	CANTIDAD / QUANTITY / QUANTITÉ
3,5x6,5	200	4,8x13	100
3,5x9,5	200	4,8x16	100
3,5x13	200	4,8x19	50
3,9x13	200	4,8x25	50
3,9x16	150	4,8x32	50
3,9x19	100	5,5x19	40
3,9x25	100	5,5x25	40
4,2x13	100	5,5x38	40
4,2x16	100	5,5x50	30
4,2x19	100		
4,2x25	50		

CÓDIGO / CODE / CODE DESCRIPCIÓN / DESCRIPTION / DESCRIPTION

M7982A2 MALETÍN TORNILLO DIN 7982 INOX. A-2

PRECIO TARIFA / PRICE LIST PRECIO TARIFA / PRICE LIST

€/UNIDAD €/100 u.
166,67 16.667,00

PEDIDO MÍNIMO 1 EMBALAJE / MINIMUM ORDER 1 PACKAGING



INOXIDABLE A4

STAINLESS STEEL AISI 316

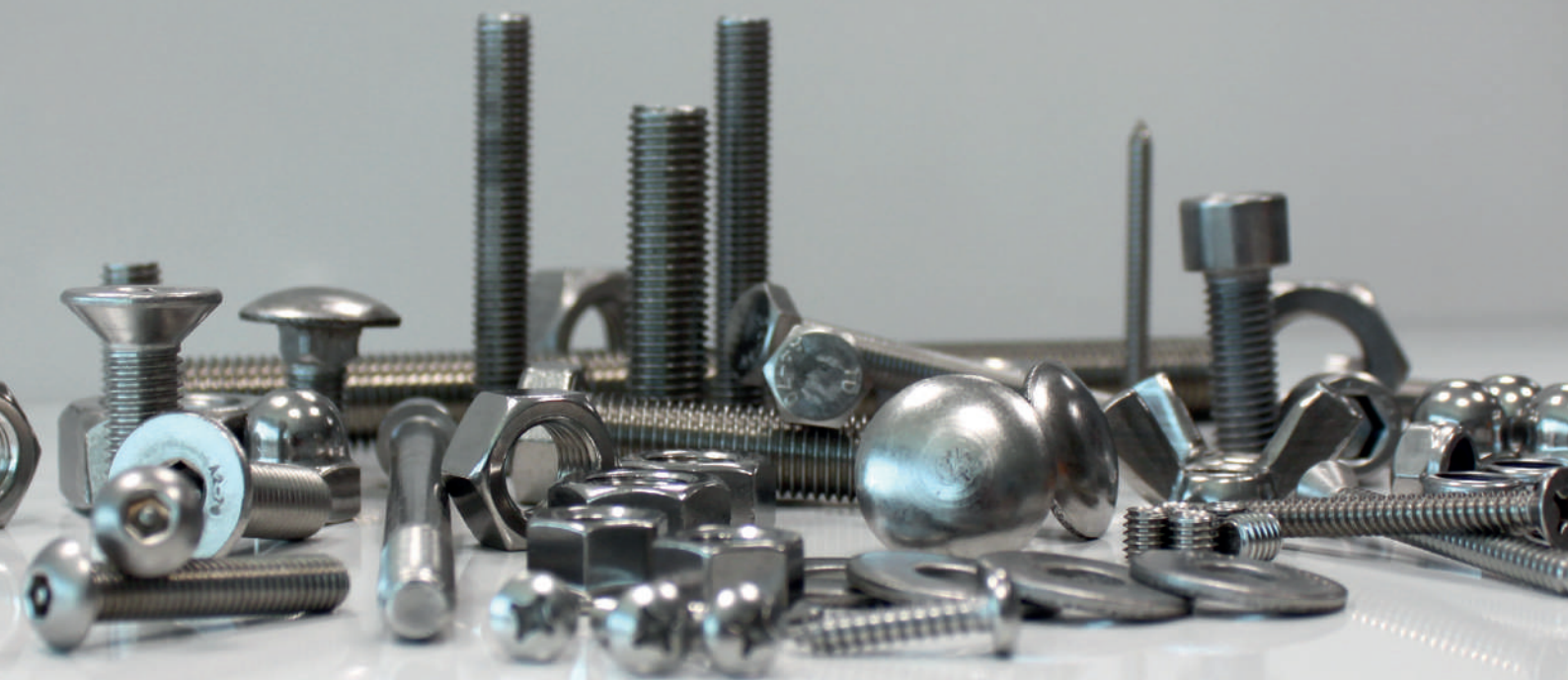

**LUSAN SUMINISTRA TORNILLERÍA INOXIDABLE A4 BAJO PEDIDO
CON LA MAYOR EFICACIA Y GARANTIZANDO LA MÁXIMA CALIDAD**



**LUSAN SUPPLIES STAINLESS STEEL AISI 316 SCREWS ON REQUEST WITH
THE MOST EFFICIENCY AND GUARANTEEING THE MAXIMUM QUALITY**

**LUSAN FOURNIT VISSERIE INOXYDABLE A4 SUR COMMANDE DE LA MANIÈRE
LA PLUS EFFICACE ET EN GARANTISSANT LA MEILLEURE QUALITÉ**



REMACHE TUBULAR DIN 7337 - ALUMINIO / ACERO

 ALUMINIUM / STEEL BLIND RIVET DIN 7337
 RIVET TUBULAIRE DIN 7337 EN ALUMINIUM / ACIER
 BLINDNIETE DIN 7337 AUS ALUMINIUM / STAHL



CAJA
ALUM. / ACERO

CÓDIGO CODE CODE	MEDIDA SIZE MESURE			PRECIO TARIFA PRICE LIST PRIX TARIFS
				
	m.m.			€/100 u.
RESA2406	2,4x 6	500	10.000	2,23
RESA2408	2,4x 8	500	10.000	2,23
RESA3005	3,0x 5	500	10.000	1,57
RESA3006	3,0x 6	500	10.000	1,77
RESA3008	3,0x 8	500	10.000	1,93
RESA3010	3,0x10	500	10.000	2,00
RESA3012	3,0x12	500	10.000	2,17
RESA3206	3,2x 6	500	10.000	1,73
RESA3208	3,2x 8	500	10.000	1,83
RESA3210	3,2x10	500	10.000	1,90
RESA3212	3,2x12	500	10.000	2,07
RESA3215	3,2x15	500	10.000	2,30
RESA3218	3,2x18	500	10.000	2,37
RESA4006	4,0x 6	500	10.000	2,37
RESA4008	4,0x 8	500	10.000	2,50
RESA4010	4,0x10	500	10.000	2,73
RESA4012	4,0x12	500	10.000	2,73
RESA4014	4,0x14	500	10.000	3,20
RESA4016	4,0x16	500	10.000	3,47
RESA4018	4,0x18	500	10.000	3,70
RESA4020	4,0x20	500	10.000	3,73



ALUM. / ACERO

CÓDIGO CODE CODE	MEDIDA SIZE MESURE			PRECIO TARIFA PRICE LIST PRIX TARIFS
				
	m.m.			€/100 u.
RESA4806	4,8x 6	500	10.000	3,30
RESA4808	4,8x 8	500	10.000	3,80
RESA4810	4,8x10	500	10.000	4,00
RESA4812	4,8x12	500	10.000	4,23
RESA4814	4,8x14	500	5.000	4,67
RESA4816	4,8x16	500	5.000	4,90
RESA4818	4,8x18	500	5.000	5,23
RESA4821	4,8x21	500	5.000	6,00
RESA4824	4,8x24	250	5.000	7,39
RESA4830	4,8x30	250	2.500	17,60
RESA6008	6,0x8	250	2.500	13,23
RESA6010	6,0x10	250	2.500	14,10
RESA6012	6,0x12	250	2.500	14,63
RESA6016	6,0x16	250	2.500	15,47
RESA6018	6,0x18	250	2.500	15,93
RESA6020	6,0x20	250	2.500	17,07
RESA6025	6,0x25	250	2.500	18,63
RESA6412	6,4x12	250	2.500	16,70
RESA6415	6,4x15	250	2.500	17,73
RESA6418	6,4x18	250	2.500	18,93

BLISTERS
ALUM. / ACERO

CÓDIGO CODE CODE	MEDIDA SIZE MESURE			PRECIO TARIFA PRICE LIST PRIX TARIFS
				
	m.m.			€/BLISTER
BRESA3208	3,2x 8	15	20	1,60
BRESA3210	3,2x10	15	20	1,60
BRESA4008	4,0x 8	15	20	1,60
BRESA4010	4,0x10	15	20	1,60
BRESA4012	4,0x12	15	20	1,60
BRESA4016	4,0x16	15	20	1,60

BLISTERS
ALUM. / ACERO

CÓDIGO CODE CODE	MEDIDA SIZE MESURE			PRECIO TARIFA PRICE LIST PRIX TARIFS
				
	m.m.			€/BLISTER
BRESA4810	4,8x10	15	20	1,60
BRESA4812	4,8x12	15	20	1,60
BRESA4816	4,8x16	8	20	1,60
BRESA4821	4,8x21	8	20	1,60
BRESA4824	4,8x24	8	20	1,60

PEDIDO MÍNIMO 1 EMBALAJE / MINIMUM ORDER 1 PACKAGING
 COMMANDE MINIMALE 1 EMBALLAGE / MINDESTBESTELLMENGE 1 VERPACKUNG



INFORMACIÓN TÉCNICA
 TECHNICAL INFORMATION
 INFORMATION TECHNIQUE
 TECHNISCHE INFORMATIONEN
 REF.: RESA / RESAA

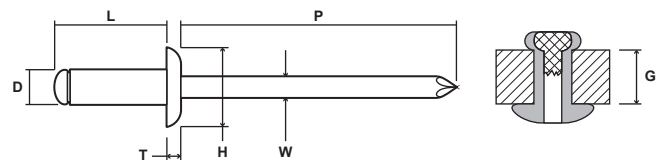

RESA

MEDIDA REMACHE RIVET MEASURE	Ø REMACHE RIVET Ø	Ø CABEZA HEAD Ø	ALTURA CABEZA HEAD HEIGHT	MAND. SALIENTE MAND. PROTRUSION	Ø MANDRIL MANDREL Ø	CIZALLA TÍPICA TYPICAL SHEAR	TENSIÓN TÍPICA TYPICAL TENSILE	Ø AGUJERO REC. REC. HOLE Ø
	(D) m.m.	(H) m.m.	(T) m.m.	MIN. (P) m.m.	NOM. (W) m.m.	MIN. N	MIN. N	m.m.
2,4	2,30-2,48	4,3-5,0	0,5-0,8	27	1,40	300	350	2,5-2,6
3,0	2,90-3,08	5,8-6,5	0,8-1,2	27	1,75	480	550	3,1-3,2
3,2	3,05-3,28	5,8-6,5	0,8-1,2	27	1,75	535	650	3,3-3,4
3,4	3,30-3,45	5,8-6,7	0,8-1,2	27	1,81	535	650	3,5-3,6
3,8	3,70-3,88	7,0-8,0	0,9-1,5	27	2,08	750	900	3,9-4,0
4,0	3,85-4,08	7,0-8,0	0,9-1,5	27	2,08	850	1.020	4,1-4,2
4,8	4,65-4,88	8,5-9,5	1,0-1,6	27	2,58	1.160	1.420	4,9-5,0
5,0	4,85-5,08	8,5-9,5	1,0-1,6	27	2,68	1.320	1.610	5,1-5,2
6,0	5,85-6,08	10,5-12,0	1,1-1,9	30	3,30	1.830	2.140	6,1-6,2
6,4	6,25-6,48	11,5-13,0	1,4-2,2	30	3,80	2.050	2.500	6,5-6,6



REMACHE TUBULAR DIN 7337 CABEZA ANCHA - ALUMINIO / ACERO

 ALUMINIUM / STEEL WIDE HEAD BLIND RIVET DIN 7337
 RIVET TUBULAIRE TÊTE LARGE DIN 7337 EN ALUMINIUM / ACIER
 BREITENKOPF-BLINDNIETE DIN 7337 AUS ALUMINIUM / STAHL



CAJA
ALUM. / ACERO

CÓDIGO CODE CODE	MEDIDA SIZE MEASURE m.m.			PRECIO TARIFA PRICE LIST PRIX TARIFS €/100 u.
RESAA3208	3,2x 8	500	10.000	7,50
RESAA3210	3,2x10	500	10.000	8,63
RESAA3212	3,2x12	500	10.000	9,30
RESAA4008	4,0x 8	500	10.000	6,47
RESAA4010	4,0x10	500	5.000	7,03
RESAA4012	4,0x12	500	5.000	8,80
RESAA4014	4,0x14	500	5.000	10,00
RESAA4016	4,0x16	500	5.000	10,97
RESAA4018	4,0x18	250	5.000	12,20
RESAA4020	4,0x20	250	5.000	14,70

ALUM. / ACERO

CÓDIGO CODE CODE	MEDIDA SIZE MEASURE m.m.			PRECIO TARIFA PRICE LIST PRIX TARIFS €/100 u.
RESAA4810	4,8x10	500	5.000	8,77
RESAA4812	4,8x12	500	5.000	9,30
RESAA4814	4,8x14	250	5.000	11,07
RESAA4816	4,8x16	250	5.000	11,97
RESAA4818	4,8x18	250	2.500	13,27
RESAA4821	4,8x21	250	2.500	15,03
RESAA4824	4,8x24	250	2.500	16,80
RESAA4827	4,8x27	200	2.000	17,83
RESAA4830	4,8x30	200	2.000	19,70
RESAA4835	4,8x35	200	2.000	22,57

BLISTERS
ALUM. / ACERO

CÓDIGO CODE CODE	MEDIDA SIZE MEASURE m.m.			PRECIO TARIFA PRICE LIST PRIX TARIFS €/BLISTER
BRESAA4010	4,0x10	8	20	1,60
BRESAA4012	4,0x12	8	20	1,60
BRESAA4016	4,0x16	8	20	1,60
BRESAA4810	4,8x10	8	20	1,60
BRESAA4812	4,8x12	8	20	1,60
BRESAA4814	4,8x14	8	20	1,60
BRESAA4816	4,8x16	8	20	1,60
BRESAA4818	4,8x18	5	20	1,60

**PEDIDO MÍNIMO 1 EMBALAJE
MINIMUM ORDER 1 PACKAGING**

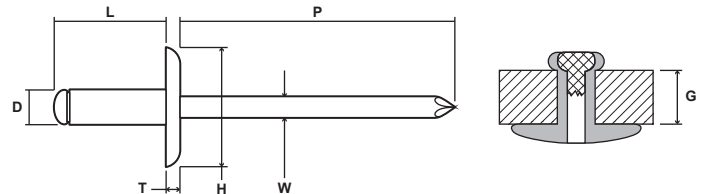

 INFORMACIÓN TÉCNICA
 TECHNICAL INFORMATION
 INFORMATION TECHNIQUE
 TECHNISCHE INFORMATIONEN
 REF.: RESA / RESAA

RESAA

MEDIDA REMACHE / CABEZA MEASURE RIVET / HEAD	Ø REMACHE RIVET Ø	Ø CABEZA HEAD Ø	ALTURA CABEZA HEAD HEIGHT	MAND. SALIENTE MAND. PROTRUSION	Ø MANDRIL MANDREL Ø	CIZALLA TÍPICA TYPICAL SHEAR	TENSIÓN TÍPICA TYPICAL TENSILE	Ø AGUJERO REC. REC. HOLE Ø
	(D) m.m.	(H) m.m.	(T) m.m.	MIN. (P) m.m.	NOM. (W) m.m.	MIN. N	MIN. N	m.m.
3,2 / 9,6	3,05-3,28	8,8-9,8	1,2-1,6	27	1,81	535	650	3,3-3,4
4,0 / 10	3,85-4,08	9,0-10,5	1,4-1,9	27	2,18	850	1.020	4,1-4,2
4,0 / 12	3,85-4,08	11,0-12,5	1,4-1,9	27	2,18	850	1.020	4,1-4,2
4,8 / 11	4,65-4,88	10,0-11,5	1,5-2,3	27	2,68	1.160	1.420	4,9-5,0
4,8 / 14	4,65-4,88	13,0-14,5	1,5-2,3	27	2,68	1.160	1.420	4,9-5,0
4,8 / 16	4,65-4,88	15,0-16,5	1,5-2,3	27	2,68	1.160	1.420	4,9-5,0
5,0 / 11	4,85-5,08	10,0-11,5	1,5-2,3	27	2,68	1.320	1.610	5,1-5,2
5,0 / 14	4,85-5,08	13,0-14,5	1,5-2,3	27	2,68	1.320	1.610	5,1-5,2
5,0 / 16	4,85-5,08	15,0-16,5	1,5-2,3	27	2,68	1.320	1.610	5,1-5,2
6,4 / 19	6,25-6,48	17,5-19,0	2,4-2,9	30	3,80	2.050	2.500	6,5-6,6

REMACHE TUBULAR DIN 7337 - ACERO / ACERO

 STEEL / STEEL BLIND RIVET DIN 7337
 RIVET TUBULAIRE DIN 7337 EN ACIER / ACIER
 BLINDNIETE DIN 7337 AUS STAHL / STAHL

CAJA
ACERO AISI 306

CÓDIGO CODE CODE	MEDIDA SIZE MESURE m.m.			PRECIO TARIFA
				PRICE LIST PRIX TARIFS €/100 u.
RA3006	3,0x 6	500	10.000	6,67
RA3008	3,0x 8	500	10.000	6,73
RA3010	3,0x10	500	10.000	6,90
RA3012	3,0x12	500	10.000	7,13
RA3206	3,2x 6	500	10.000	6,70
RA3208	3,2x 8	500	10.000	6,87
RA3210	3,2x10	500	10.000	7,03
RA3212	3,2x12	500	10.000	7,30
RA4006	4,0x 6	500	5.000	7,93
RA4008	4,0x 8	500	5.000	8,17
RA4010	4,0x10	500	5.000	8,37
RA4012	4,0x12	500	5.000	9,20
RA4016	4,0x16	500	5.000	11,90
RA4018	4,0x18	500	5.000	12,17
RA4020	4,0x20	500	5.000	12,47

ACERO AISI 306



CÓDIGO CODE CODE	MEDIDA SIZE MESURE m.m.			PRECIO TARIFA
				PRICE LIST PRIX TARIFS €/100 u.
RA4806	4,8x 6	500	5.000	9,93
RA4808	4,8x 8	500	5.000	10,27
RA4810	4,8x10	500	5.000	10,60
RA4812	4,8x12	500	5.000	11,47
RA4814	4,8x14	500	5.000	13,50
RA4816	4,8x16	500	5.000	13,97
RA4818	4,8x18	500	5.000	14,73
RA4821	4,8x21	500	5.000	15,43
RA4824	4,8x24	250	2.500	19,27
RA4830	4,8x30	250	2.500	22,17
RA6412	6,4x12	250	2.500	22,00
RA6415	6,4x15	250	2.500	23,13
RA6418	6,4x18	250	2.500	25,07
RA6422	6,4x22	250	2.500	27,37
RA6425	6,4x25	250	2.500	29,07
RA6430	6,4x30	200	2.000	34,47

 INFORMACIÓN TÉCNICA
 TECHNICAL INFORMATION
 INFORMATION TECHNIQUE
 TECHNISCHE INFORMATIONEN
 REF.: RA



REMACHE TUBULAR DIN 7337 - INOX A-2 / INOX A-2

 STAINLESS STEEL AISI 304 / STAINLESS STEEL AISI 304 BLIND RIVET DIN 7337
 RIVET TUBULAIRE DIN 7337 EN ACIER INOX A-2 / ACIER INOX A-2
 BLINDNIETE DIN 7337 AUS EDELSTAHL A-2 / EDELSTAHL A-2

CAJA
INOX. A-2

CÓDIGO CODE CODE	MEDIDA SIZE MESURE m.m.			PRECIO TARIFA
				PRICE LIST PRIX TARIFS €/100 u.
RESA23206	3,2x 6	500	10.000	16,07
RESA23208	3,2x 8	500	10.000	16,53
RESA23210	3,2x10	500	10.000	17,47
RESA23212	3,2x12	500	10.000	17,83
RESA23215	3,2x15	500	10.000	18,57
RESA24006	4,0x 6	500	5.000	19,27
RESA24008	4,0x 8	500	5.000	20,13
RESA24010	4,0x10	500	5.000	21,03
RESA24012	4,0x12	500	5.000	22,03
RESA24016	4,0x16	500	5.000	24,27

INOX. A-2



CÓDIGO CODE CODE	MEDIDA SIZE MESURE m.m.			PRECIO TARIFA
				PRICE LIST PRIX TARIFS €/100 u.
RESA24808	4,8x 8	500	5.000	28,17
RESA24810	4,8x10	500	5.000	29,13
RESA24812	4,8x12	500	5.000	30,10
RESA24814	4,8x14	500	5.000	31,90
RESA24816	4,8x16	500	5.000	32,80
RESA24818	4,8x18	500	5.000	35,27
RESA24820	4,8x20	500	5.000	36,23
RESA24825	4,8x25	250	2.500	43,27
RESA24830	4,8x30	250	2.500	45,30

 INFORMACIÓN TÉCNICA
 TECHNICAL INFORMATION
 INFORMATION TECHNIQUE
 TECHNISCHE INFORMATIONEN
 REF.: RESA2



REMACHE TUBULAR FLOR - ALUMINIO / ACERO

 ALUMINIUM / STEEL PEEL DOMED HEAD BLIND RIVET
 RIVET TUBULAIRE ECLATE EN ALUMINIUM / ACIER
 SCHÄLEN GEWÖLBTKOPF-BLINDNIETE AUS ALUMINIUM / STAHL



CAJA
ALUM. / ACERO

CÓDIGO CODE CODE	MEDIDA SIZE MESURE m.m.			PRECIO TARIFA
				PRICE LIST PRIX TARIFS €/100 u.
RESAF4010	4,0x10	500	10.000	7,83
RESAF4012	4,0x12	500	10.000	8,13
RESAF4014	4,0x14	500	10.000	8,37
RESAF4016	4,0x16	500	10.000	8,77
RESAF4018	4,0x18	500	10.000	8,97
RESAF4020	4,0x20	500	5.000	9,10
RESAF4025	4,0x25	250	5.000	10,17
RESAF4810	4,8x10	500	5.000	9,77
RESAF4812	4,8x12	500	5.000	10,03
RESAF4814	4,8x14	500	5.000	11,37

ALUM. / ACERO



CÓDIGO CODE CODE	MEDIDA SIZE MESURE m.m.			PRECIO TARIFA
				PRICE LIST PRIX TARIFS €/100 u.
RESAF4816	4,8x16	500	5.000	11,57
RESAF4818	4,8x18	500	5.000	11,97
RESAF4821	4,8x21	250	5.000	12,43
RESAF4824	4,8x24	250	5.000	13,33
RESAF4830	4,8x30	250	2.500	14,13
RESAF4835	4,8x35	250	2.000	14,23
RESAF4840	4,8x40	150	1.500	14,87
RESAF4845	4,8x45	100	1.200	19,38
RESAF4850	4,8x50	100	1.200	21,57

BLISTERS
ALUM. / ACERO

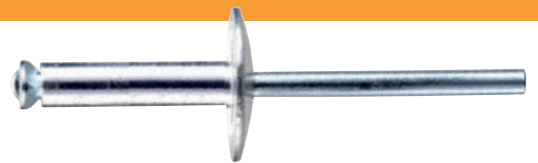

CÓDIGO CODE CODE	MEDIDA SIZE MESURE m.m.			PRECIO TARIFA
				PRICE LIST PRIX TARIFS €/BLISTER
BRESAF4816	4,8x16	10	20	1,60
BRESAF4821	4,8x21	10	20	1,60
BRESAF4824	4,8x24	10	20	1,60
BRESAF4830	4,8x30	8	20	1,60
BRESAF4835	4,8x35	5	20	1,60

**PEDIDO MÍNIMO 1 EMBALAJE
MINIMUM ORDER 1 PACKAGING**
REMACHE TUBULAR FLOR CABEZA ANCHA - ALUMINIO / ACERO

 ALUMINIUM / STEEL PEEL WIDE HEAD BLIND RIVET
 RIVET TUBULAIRE ECLATE TÊTE LARGE EN ALUMINIUM / ACIER
 SCHÄLEN GEWÖLBTKOPF-BREITENKOPF-BLINDNIETE AUS ALUMINIUM / STAHL

CAJA
ALUM. / ACERO

CÓDIGO CODE CODE	MEDIDA SIZE MESURE m.m.			PRECIO TARIFA
				PRICE LIST PRIX TARIFS €/100 u.
RFA4008	4,0x8	500	5.000	11,63
RFA4010	4,0x10	500	5.000	9,47
RFA4012	4,0x12	500	5.000	10,23
RFA4014	4,0x14	500	5.000	10,63
RFA4016	4,0x16	500	5.000	11,20
RFA4018	4,0x18	250	5.000	11,60
RFA4020	4,0x20	250	5.000	11,97
RFA4810	4,8x10	500	5.000	12,33
RFA4812	4,8x12	500	5.000	12,60

ALUM. / ACERO

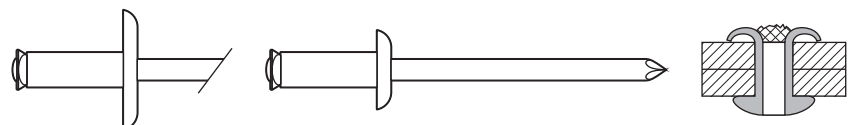

CÓDIGO CODE CODE	MEDIDA SIZE MESURE m.m.			PRECIO TARIFA
				PRICE LIST PRIX TARIFS €/100 u.
RFA4814	4,8x14	250	5.000	14,03
RFA4816	4,8x16	250	5.000	14,03
RFA4818	4,8x18	250	2.500	14,57
RFA4821	4,8x21	250	2.500	15,00
RFA4824	4,8x24	250	2.500	16,47
RFA4827	4,8x27	150	1.500	16,87
RFA4830	4,8x30	150	1.500	17,33
RFA4835	4,8x35	100	1.200	18,13

 INFORMACIÓN TÉCNICA
 TECHNICAL INFORMATION
 INFORMATION TECHNIQUE
 TECHNISCHE INFORMATIONEN
 REF.: RESAF / RFA



REMACHE TUBULAR DIN 7337 LACADO BLANCO Y NEGRO - ALUMINIO / ACERO

 BLACK AND WHITE ALUMINIUM / STEEL BLIND RIVET DIN 7337
 RIVET TUBULAIRE DIN 7337 EN ALUMINIUM / ACIER BLANC ET NOIR
 BLINDNIETE DIN 7337 AUS ALUMINIUM / STAHL VERZINKT SCHWARZ UND WEISS

CAJA
BLANCO / WHITE
ALU. / AC.

CÓDIGO CODE CODE	MEDIDA SIZE MESURE			PRECIO TARIFA
				PRICE LIST PRIX TARIFS
				€/100 u.
RESAB3206	3,2x 6	500	10.000	7,27
RESAB3208	3,2x 8	500	10.000	7,63
RESAB3210	3,2x10	500	10.000	7,77
RESAB3212	3,2x12	500	10.000	8,03
RESAB4006	4,0x 6	500	10.000	7,97
RESAB4008	4,0x 8	500	10.000	8,33
RESAB4010	4,0x10	500	10.000	9,00
RESAB4012	4,0x12	500	10.000	9,47
RESAB4014	4,0x14	500	10.000	9,63
RESAB4808	4,8x 8	500	10.000	9,97
RESAB4810	4,8x10	500	10.000	10,20
RESAB4812	4,8x12	500	10.000	10,80
RESAB4814	4,8x14	500	5.000	12,07
RESAB4816	4,8x16	500	5.000	13,00

CAJA
NEGRO / BLACK
ALU. / AC.



CÓDIGO CODE CODE	MEDIDA SIZE MESURE			PRECIO TARIFA
				PRICE LIST PRIX TARIFS
				€/100 u.
RESN3206	3,2x 6	500	10.000	7,27
RESN3208	3,2x 8	500	10.000	7,63
RESN3210	3,2x10	500	10.000	7,77
RESN3212	3,2x12	500	10.000	8,03
RESN4006	4,0x 6	500	10.000	7,97
RESN4008	4,0x 8	500	10.000	8,33
RESN4010	4,0x10	500	10.000	9,00
RESN4012	4,0x12	500	10.000	9,47
RESN4014	4,0x14	500	10.000	9,63
RESN4808	4,8x 8	500	10.000	9,97
RESN4810	4,8x10	500	10.000	10,20
RESN4812	4,8x12	500	10.000	10,80
RESN4814	4,8x14	500	5.000	12,07
RESN4816	4,8x16	500	5.000	13,00

 INFORMACIÓN TÉCNICA
 TECHNICAL INFORMATION
 INFORMATION TECHNIQUE
 TECHNISCHE INFORMATIONEN
 REF.: RESAB / RESN



REMACHE TUBULAR CABEZA MULTIGRIP - ALUMINIO / ACERO

 ALUMINIUM / STEEL MULTIGRIP HEAD BLIND RIVET
 RIVET TUBULAIRE TÊTE MULTIGRIP EN ALUMINIUM / ACIER
 MULTIGRIP BLINDNIETE AUS ALUMINIUM / STAHL

CAJA
ALUM. / ACERO

CÓDIGO CODE CODE	MEDIDA SIZE MESURE			PRECIO TARIFA
				PRICE LIST PRIX TARIFS
				€/100 u.
RAM32082	3,2x 8,2	500	10.000	9,40
RAM32114	3,2x11,4	500	10.000	9,50
RAM40105	4,0x10,5	500	10.000	10,63
RAM40120	4,0x12,0	500	10.000	11,23
RAM40168	4,0x16,8	500	10.000	11,83

ALUM. / ACERO

CÓDIGO CODE CODE	MEDIDA SIZE MESURE			PRECIO TARIFA
				PRICE LIST PRIX TARIFS
				€/100 u.
RAM48111	4,8x11,1	500	5.000	13,43
RAM48159	4,8x15,9	500	5.000	13,97
RAM48175	4,8x17,5	500	5.000	14,20
RAM48238	4,8x23,8	250	5.000	16,10

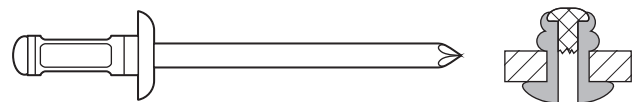
 INFORMACIÓN TÉCNICA
 TECHNICAL INFORMATION
 INFORMATION TECHNIQUE
 TECHNISCHE INFORMATIONEN
 REF.: RAM

REMACHE TUBULAR DIN 7337 CABEZA AVELLANADA - ALUMINIO / ACERO

ALUMINIUM / STEEL COUNTERSUNK HEAD BLIND RIVET DIN 7337
RIVET TUBULAIRE TÊTE FRAISÉE DIN 7337 EN ALUMINIUM / ACIER
BLINDNIETE MIT SENKKOPF DIN 7337 AUS ALUMINIUM / STAHL



CAJA

ALUM. / ACERO

CÓDIGO CODE CODE	MEDIDA SIZE MESURE m.m.			PRECIO TARIFA
				PRICE LIST PRIX TARIFS €/100 u.
RAC3206	3,2x 6	500	10.000	6,73
RAC3208	3,2x 8	500	10.000	7,13
RAC3210	3,2x10	500	10.000	7,27
RAC3212	3,2x12	500	10.000	7,27
RAC3215	3,2x15	500	10.000	8,94
RAC3218	3,2x18	500	10.000	10,72
RAC4006	4,0x 6	500	10.000	7,70
RAC4008	4,0x 8	500	10.000	8,23
RAC4010	4,0x10	500	10.000	8,40
RAC4012	4,0x12	500	10.000	8,77
RAC4014	4,0x14	500	10.000	8,97
RAC4016	4,0x16	500	10.000	8,79
RAC4018	4,0x18	500	10.000	9,38

ALUM. / ACERO

CÓDIGO CODE CODE	MEDIDA SIZE MESURE m.m.			PRECIO TARIFA
				PRICE LIST PRIX TARIFS €/100 u.
RAC4020	4,0x20	500	10.000	11,10
RAC4806	4,8x 6	500	10.000	9,77
RAC4808	4,8x 8	500	10.000	10,23
RAC4810	4,8x10	500	10.000	10,67
RAC4812	4,8x12	500	10.000	10,93
RAC4814	4,8x14	500	5.000	12,00
RAC4816	4,8x16	500	5.000	12,27
RAC4818	4,8x18	500	5.000	12,87
RAC4821	4,8x21	500	5.000	13,20
RAC4824	4,8x24	250	5.000	14,00
RAC4827	4,8x27	250	2.500	16,09
RAC4830	4,8x30	250	2.500	18,64
RAC4835	4,8x35	200	2.000	19,50



INFORMACIÓN TÉCNICA
TECHNICAL INFORMATION
INFORMATION TECHNIQUE
TECHNISCHE INFORMATIONEN
REF.: RAC

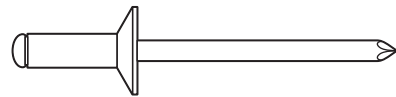

REM. TUBULAR TRÉBOL - ALUMINIO / ALUMINIO

ALUMINIUM / ALUMINIUM "CLOVER" BLIND RIVET
RIVET TUBULAIRE TRÉFLE EN ALUMINIUM / ALUMINIUM
KLEE-BLINDNIETE AUS ALUMINIUM / ALUMINIUM



CAJA

ALUM. / ALUM.

CÓDIGO CODE CODE	MEDIDA SIZE MESURE m.m.			PRECIO TARIFA
				PRICE LIST PRIX TARIFS €/100 u.
RAT40136	4,0x13,6	500	8.000	15,87
RAT40188	4,0x18,8	250	4.000	16,90
RAT40245	4,0x24,5	250	4.000	19,43
RAT48153	4,8x15,3	250	4.000	18,00
RAT48205	4,8x20,5	250	2.000	18,73
RAT48245	4,8x24,5	200	1.600	20,00
RAT48280	4,8x28,0	200	1.600	22,04

REM. T. TRÉBOL C/ ANCHA - ALUMINIO / ALUMINIO

ALUMINIUM / ALUMINIUM "CLOVER" WIDE HEAD BLIND RIVET
RIVET TUBULAIRE TRÉFLE TÊTE LARGE EN ALUMINIUM / ALUMINIUM
BREITENKOPF KLEE-BLINDNIETE AUS ALUMINIUM / STAHL



CAJA

ALUM. / ALUM.

CÓDIGO CODE CODE	*MEDIDA SIZE MESURE m.m.			PRECIO TARIFA
				PRICE LIST PRIX TARIFS €/100 u.
RATAN40188	4,0x18,8	250	2.000	19,50
RATAN48205	4,8x20,5	200	1.600	21,60

* Cabeza / Head / Tête : Ø 14mm



INFORMACIÓN TÉCNICA
TECHNICAL INFORMATION
INFORMATION TECHNIQUE
TECHNISCHE INFORMATIONEN
REF.: RAT / RATAN

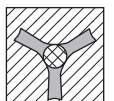
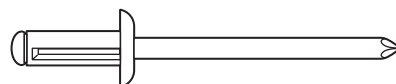
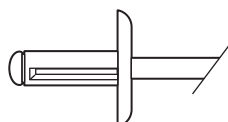

REMACHE TUBULAR ESTANCO - ALUMINIO / ACERO

ALUMINIUM / STEEL SEALED HEAD BLIND RIVET
RIVET TUBULAIRE ETANCHE DIN 7337 EN ALUMINIUM / ACIER
VERSIEGELT-BREITENKOPF BLINDNIETE AUS ALUMINIUM / STAHL



CAJA

ALUM. / ACERO

CÓDIGO CODE CODE	MEDIDA SIZE MESURE m.m.			PRECIO TARIFA PRICE LIST PRIX TARIFS €/100 u.
RAE3208	3,2x 8,0	500	10.000	13,13
RAE3209	3,2x 9,5	500	10.000	13,97
RAE3212	3,2x12,5	500	10.000	15,69
RAE4009	4,0x 9,5	500	10.000	16,57
RAE4011	4,0x11,0	500	10.000	19,04

ALUM. / ACERO

CÓDIGO CODE CODE	MEDIDA SIZE MESURE m.m.			PRECIO TARIFA PRICE LIST PRIX TARIFS €/100 u.
RAE4012	4,0x12,5	500	10.000	21,25
RAE4809	4,8x 9,5	500	10.000	21,41
RAE4811	4,8x11,0	500	10.000	23,25
RAE4813	4,8x13,0	250	5.000	24,35
RAE4816	4,8x16,0	250	5.000	29,82



INFORMACIÓN TÉCNICA
TECHNICAL INFORMATION
INFORMATION TECHNIQUE
TECHNISCHE INFORMATIONEN
REF.: RAE

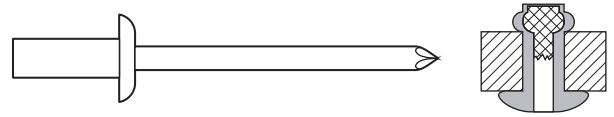

TUERCA REMACHABLE CABEZA BAJA CINCADA

REDUCED HEAD BLIND RIVET NUT - ZINC PLATED
ÉCROU À SERTIR TÊTE RÉDUITE EN ACIER ZINGUÉ
REDUZIERKOPF-BLINDNIET MUTTERN VERZINKT



INFORMACIÓN TÉCNICA
TECHNICAL INFORMATION
INFORMATION TECHNIQUE
TECHNISCHE INFORMATIONEN
REF.: TRCB



CAJA

CINCADO

CÓDIGO CODE CODE	MÉTRICA METRICS MÉTRIQUE (D1) m.m.	ESPESOR A FIJAR GRIP RANGE ÉPAISSEUR (G) m.m.	Ø CABEZA Ø HEAD Ø TÊTE (B) m.m.			PRECIO TARIFA PRICE LIST PRIX TARIFS €/100 u.
TRCB04	M 4	0,50-2,50	7,1	500	10.000	10,13
TRCB05	M 5	0,50-3,00	8,1	500	10.000	11,50
TRCB06	M 6	0,70-3,50	10,5	500	5.000	14,91
TRCB08	M 8	1,00-3,50	11,5	250	2.500	22,07

TUERCA REMACHABLE CABEZA BAJA INOXIDABLE A-2

REDUCED HEAD BLIND RIVET NUT - STAINLESS STEEL AISI 304
ÉCROU À SERTIR TÊTE RÉDUITE EN ACIER INOX A-2
REDUZIERKOPF-BLINDNIET MUTTERN EDELSTAHL A-2



INFORMACIÓN TÉCNICA
TECHNICAL INFORMATION
INFORMATION TECHNIQUE
TECHNISCHE INFORMATIONEN
REF.: TRCBA2



CAJA

INOX. A-2



CÓDIGO CODE CODE	MÉTRICA METRICS MÉTRIQUE (D1) m.m.	ESPESOR A FIJAR GRIP RANGE ÉPAISSEUR (G) m.m.	Ø CABEZA Ø HEAD Ø TÊTE (B) m.m.			PRECIO TARIFA PRICE LIST PRIX TARIFS €/100 u.
TRCBA204	M 4	0,50-2,50	7,1	500	10.000	49,87
TRCBA205	M 5	0,50-3,00	8,1	500	10.000	51,30
TRCBA206	M 6	0,70-3,50	10,5	500	5.000	72,93
TRCBA208	M 8	1,00-3,50	11,5	250	2.500	103,87

TUERCA REMACHABLE CABEZA ANCHA CINCADA

 BLIND RIVET NUT - ZINC PLATED
 ÉCROU À SERTIR EN ACIER ZINGUÉ
 BREITENKOPF-BLINDNIET MUTTERN VERZINKT

 INFORMACIÓN TÉCNICA
 TECHNICAL INFORMATION
 INFORMATION TECHNIQUE
 TECHNISCHE INFORMATIONEN
 REF.: TRCA

CAJA



CÓDIGO CODE CODE	MÉTRICA METRICS MÉTRIQUE (D 1) m.m.	ESPESOR A FIJAR GRIP RANGE ÉPAISSEUR (G) m.m.	Ø CABEZA Ø HEAD Ø TÊTE (B) m.m.			CINCADO	PRECIO TARIFA
							PRICE LIST PRIX TARIFS €/100 u.
TRCA04	M 4	0,30-2,50	9,0	500	10.000		10,04
TRCA05	M 5	0,50-3,00	10,0	500	10.000		11,19
TRCA06	M 6	0,50-4,00	13,0	250	5.000		14,10
TRCA08	M 8	0,80-4,00	16,0	250	2.500		20,13
TRCA10	M10	1,00-5,00	19,0	150	1.500		24,85

TUERCA REMACHABLE HEXAGONAL CINCADA

 HEXAGONAL BLIND RIVET NUTS ZINC PLATED
 ÉCROU À SERTIR HEXAGONAL EN ACIER ZINGUÉ
 SECHSKANT-BLINDNIET MUTTERN VERZINKT

 INFORMACIÓN TÉCNICA
 TECHNICAL INFORMATION
 INFORMATION TECHNIQUE
 TECHNISCHE INFORMATIONEN
 REF.: TRE

CAJA



CÓDIGO CODE CODE	MÉTRICA METRICS MÉTRIQUE (D 1) m.m.	ESPESOR A FIJAR GRIP RANGE ÉPAISSEUR (G) m.m.	Ø CABEZA Ø HEAD Ø TÊTE (B) m.m.			CINCADO	PRECIO TARIFA
							PRICE LIST PRIX TARIFS €/100 u.
TRE04	M 4	0,50-2,00	9	500	10.000		22,67
TRE05	M 5	0,50-3,00	10	500	10.000		25,17
TRE06	M 6	0,50-3,00	13	250	5.000		28,77
TRE08	M 8	0,50-3,00	16	250	2.500		37,00
TRE10	M10	0,50-3,50	19	150	1.500		57,23

NUEVO PRODUCTO / NEW PRODUCT / NOUVEAU PRODUIT
TUERCA REMACHABLE CABEZA AVELLANADA CINCADA

 STEEL BLIND RIVET NUTS WITH FLAT COUNTERSUNK HEAD ZINC PLATED
 ÉCROU À SERTIR TÊTE FRAISÉE EN ACIER ZINGUÉ
 SENKKOPF-BLINDNIET MUTTERN VERZINKT

 INFORMACIÓN TÉCNICA
 TECHNICAL INFORMATION
 INFORMATION TECHNIQUE
 TECHNISCHE INFORMATIONEN
 REF.: TRAV

CAJA

CÓDIGO CODE CODE	MÉTRICA METRICS MÉTRIQUE (D 1) m.m.	ESPESOR A FIJAR GRIP RANGE ÉPAISSEUR (G) m.m.	Ø CABEZA Ø HEAD Ø TÊTE (B) m.m.			CINCADO	PRECIO TARIFA
							PRICE LIST PRIX TARIFS €/100 u.
TRAV04	M 4	2,0-3,5	9	500	10.000		10,13
TRAV05	M 5	2,5-4,0	10	500	10.000		11,50
TRAV06	M 6	2,5-4,5	12	250	5.000		14,91
TRAV08	M 8	2,5-4,5	14	250	2.500		22,07
TRAV10	M10	2,5-5,0	15	150	1.500		36,63

REMATCHADORAS

RIVETERS / RIVETEUSES / NIETMASCHINES

REMATCHADORA MANUAL

CARACTERÍSTICAS / CHARACTERISTICS / CARACTÉRISTIQUES

- DISEÑO DE 2 MORDAZAS
- MANGO CON SUPERFICIE DE AGARRE
- CARCASA DE LAS MORDAZAS HECHA EN ACERO CROMADO Y TRATAMIENTO DE CALOR
- PESO: 0,53 KG
- HAND-RIVETER WITH 2-JAWS DESIGN
- HANDLE WITH POWDER SURFACE
- JAW & JAW CASE MADE OF CHROME STEEL AND HEAT TREATED
- WEIGHT: 0.53 KG.
- CONCEPTION DE 2 BÂILLONS
- MANCHE AVEC SURFACE DE PRÉHENSION
- DOUILLE DE LE BÂILLONS EN ACIER CHROMÉ ET TRAITEMENT THERMIQUE
- POIDS: 0,53 KG

CÓDIGO
 CODE / CODE

CAPACIDAD
 CAPACITY / CAPACITÉ
 m.m.

PRECIO TARIFA / PRICE LIST
PRECIO TARIFA / PRICE LIST
€/UNIDAD
€/100 U.

RME

HASTA Ø4,8

1

16,41
1.641,00
REMATCHADORA MANUAL DE 2 BRAZOS

CARACTERÍSTICAS / CHARACTERISTICS / CARACTÉRISTIQUES

- DISEÑO DE 3 MORDAZAS
- DISEÑO DE PALANCA PARA REDUCIR LA FUERZA NECESARIA
- AGARRE DISEÑADO PARA UN MAYOR CONFORT, SEGURIDAD Y UTILIDAD
- MORDAZAS: 3,2MM - 1/8", 4,0MM - 5/32", 4,8MM - 3/16", 6,0MM - 7/32", 6,4MM - 1/4". PESO: 1,845 KG
- THREE-JAW DESIGN
- LEVER DESIGN REDUCES PHYSICAL STRENGTH
- GRIP DESIGN FOR COMFORT, SAFETY AND UTILITY
- NOSEPIECE: 3,2MM - 1/8", 4,0MM - 5/32", 4,8MM - 3/16", 6,0MM - 7/32", 6,4MM - 1/4". PESO: 1,845 KG

CÓDIGO
 CODE / CODE

CAPACIDAD
 CAPACITY / CAPACITÉ
 m.m.

PRECIO TARIFA / PRICE LIST
PRECIO TARIFA / PRICE LIST
€/UNIDAD
€/100 U.

RMR6

Ø3,2 - Ø6,4

1

128,34
12.834,00
REMATCHADORA DE TUERCAS DE 2 BRAZOS

CARACTERÍSTICAS / CHARACTERISTICS / CARACTÉRISTIQUES

- REMACHADORA MANUAL DE TUERCAS PROFESIONAL
- ACCESORIOS PARA DIFERENTES MÉTRICAS INCLUIDOS (M4, M5, M6, M8, M10)
- PESO: 1,64 KG
- PROFESSIONAL NUTS HAND-RIVETER
- ACCESSORIES FOR DIFFERENT METRICS INCLUDED (M4, M5, M6, M8, M10)
- WEIGHT: 1.64 KG
- RIVETEUSE MANUEL POUR ÉCROUS PROFESSIONNEL
- ACCESSOIRES POUR DIFFÉRENTES MESURES INCLUS (M4, M5, M6, M8, M10)
- POIDS: 1,64 KG

CÓDIGO
 CODE / CODE

CAPACIDAD
 CAPACITY / CAPACITÉ
 m.m.

PRECIO TARIFA / PRICE LIST
PRECIO TARIFA / PRICE LIST
€/UNIDAD
€/100 U.

RT2B4

M4/M5/M6/M8/M10

1

314,13
31.413,00
REMATCHADORA NEUMÁTICA

CARACTERÍSTICAS / CHARACTERISTICS

- LIGERA Y POTENTE
- PARA LA APLICACIÓN DE REMACHES CIEGOS
- DISEÑO CON TRES MORDIENTES: PROPORCIONA UN MEJOR RENDIMIENTO CON SÓLO CAMBIAR LA PUNTA, Y FACILITA LA EXTRACCIÓN DEL MANDRIL
- EL DEPÓSITO DE RECOGIDA ES UN ACCESORIO ESTÁNDAR, PROPORCIONA UN TRABAJO MÁS LIMPIO Y PREVIENE QUE LOS MANDRILES CAIGAN AL SUELO O SOBRE LA SUPERFICIE DE TRABAJO
- CAPACIDAD DE REMACHADO:
 - HASTA 4,8 MM (3/16") PARA TODOS LOS MATERIALES
 - HASTA 6,4 MM (1/4") PARA EL ALUMINIO
- ESPECIALMENTE INDICADA PARA LÍNEAS DE PRODUCCIÓN QUE UTILIZAN 3,2 MM (1/8") Y 4,0 MM (5/32") A GRANEL
- PESO: 1,5 KG.
- LIGHTWEIGHT AND POWERFUL
- FOR THE APPLICATION OF BLIND RIVETS
- DESIGN WITH THREE MORDANT: PROVIDES BETTER PERFORMANCE WITH ONLY CHANGE THE TIP, AND FACILITATES THE REMOVAL OF THE MANDREL
- THE COLLECTING TANK IS A STANDARD ACCESSORY AND PROVIDES A CLEANER WORK
- ABILITY RIVETING:
 - UP TO 4.8 MM (3/16") FOR ALL MATERIALS
 - UP TO 6.4 MM (1/4") FOR ALUMINUM
- SPECIALLY DESIGNED FOR PRODUCTION LINES THAT USE 3.2 MM (1/8") AND 4.0 MM (5/32") IN BULK
- WEIGHT: 1.5 KG.

CÓDIGO
 CODE / CODE

CAPACIDAD
 CAPACITY / CAPACITÉ
 m.m.

PRECIO TARIFA / PRICE LIST
PRECIO TARIFA / PRICE LIST
€/UNIDAD
€/100 U.

SRC56

HASTA Ø6,4 EN ALUMINIO

1

375,00
37.500,00

ABARCONES CON TUERCA Y ARANDELA - DIN 3570

"U" BOLT WITH NUTS AND WASHERS
 ÉTRIERS AVEC ÉCROUS ET RONDELLES
 RUNDSTAHLBÜGEL MIT MUTTER UND SCHEIBEN

W1 **W4** **W5**

- Abarcón de acero cincado con forma de "U" para la sujeción de tubo redondo.
- Incluye 2 tuercas DIN 934 y 2 arandelas DIN 7980 premontadas.



CAJA

Ø TUBO Ø PIPE Ø TUBE INCH. / m.m.	A m.m.	B m.m.	C m.m.	E m.m.	R m.m.	W1	W4	W5	
						ABARAZ ABARZ	ABARA2 ABARA2W	ABARA4 ABARA4W	
1/8	11	36	17	19	M6				100
1/4	14	40	20	19	M6	CONSULTAR PRECIO / CHECK PRICE			100
3/8	18	50	24	35	M6	48,74	99,60	136,67	100
1/2	22	53	28	35	M6	49,80	103,34	141,80	100
3/4	28	59	34	35	M6	51,54	109,87	150,74	100
1"	34	65	40	35	M6	53,47	117,14	160,87	100
ø38	39	70	42	35	M6	55,07	122,87	168,80	100
1" 1/4	43	74	49	35	M6	56,29	127,34	174,94	100
1" 1/2	49	85	57	40	M8	88,20	236,34	328,74	100
ø53	54	96	61	40	M8	93,07	254,34	-	100
ø54	55	97	62	40	M8	94,07	257,67	358,14	100
2"	61	99	70	40	M8	95,67	263,14	365,67	100
ø65	66	98	73	40	M8	96,00	264,07	366,94	100
ø70	71	102	78	40	M8	98,67	268,75	379,14	100
2" 1/2	77	113	83	40	M8	103,87	293,34	407,27	100
ø84	85	117	94	40	M8	106,34	302,60	420,20	50
3"	90	126	98	40	M8	111,07	319,40	443,47	50
ø104	105	149	114	40	M10	215,67	625,67	867,34	50
4"	115	155	125	40	M10	223,94	650,07	900,34	50
ø129	130	170	140	40	M10	239,27	702,27	971,94	50
5"	144	184	154	40	M10	253,67	750,94	1.091,32	50
ø154	155	194	164	40	M10	264,87	786,74	1.087,54	25
6"	170	210	180	40	M10	281,67	841,87	1.163,14	25
ø204	206	244	214	40	M10	313,00	957,07	1.322,14	25
8"	221	259	230	40	M10	328,80	1.009,94	1.394,54	25
ø254	256	294	264	40	M10	361,14	1.127,67	1.557,07	25
10"	275	313	284	40	M10	380,27	1.193,27	1.647,20	25
ø304	306	344	314	50	M10	409,00	1.296,94	1.790,27	25
12"	324	368	334	50	M10	434,67	1.392,74	1.922,80	25
ø350	354	407	364	50	M10	460,27	1.488,47	2.055,40	25

PRECIOS DE TARIFA / PRICE LIST / PRIX DES TARIFS / PREIS AUS TARIF - €/100 U.

CÓDIGO DE CALIDAD DEL MATERIAL UTILIZADO / QUALITY MATERIAL USED CODE

- W1** - TOTALMENTE EN ACERO CINCO / FULLY ZINC PLATED STEEL
- W2** - CINTA Y CABEZA EN ACERO INOXIDABLE A-2 Y TORNILLO EN ACERO CINCO / BAND & HEAD IN STAINLESS STEEL AISI 304 WITH ZINC PLATED SCREW
- W4** - TOTALMENTE EN ACERO INOXIDABLE A-2 / FULLY STAINLESS STEEL AISI 304
- W5** - TOTALMENTE EN ACERO INOXIDABLE A-4 / FULLY STAINLESS STEEL AISI 316

- Zinc-plated steel "U" bolt for round tube fastening.
- Includes 2 nuts DIN 934 and 2 washers DIN 7980 preassembled.

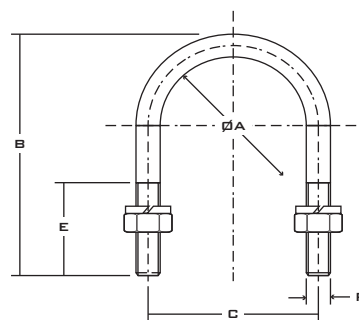

ABRAZADERA SIN FIN - DIN 3017

WORM HOSE CLAMP
 COLLIERS À CRÉMAILLÈRES
 SCHNECKENGEWINDESCHLENN



- Abrazadera de cinta para manguera en acero cincado.
- El cabezal tiene un diseño compacto y el apriete es compatible con varias herramientas.
- Recomendado para el sector industrial y agrícola.



CAJA

SERIE LIGERA / LIGHT SERIES / LÉGERÈ (9mm)

MEDIDA SIZE MESURE m.m.	W1	W2	W4	W5	
	ABL1	ABL2	ABL4	ABL5	
8-12	31,60	41,50	95,70		100
10-16	32,47	41,50	95,70	105,27	100
12-22	35,87	44,67	98,53	108,34	100
16-27	36,67	45,80	103,23	113,54	100
20-32	39,53	51,13	119,33	131,34	100
23-35	40,57	52,14	123,74		100
25-40	41,80	53,20	126,93	139,67	100
30-45	44,00	56,43	129,97	145,74	100
32-50	45,13	59,53	133,60	151,07	100
40-60	52,00	63,80	150,53	165,60	50
50-70	56,67	69,13	153,50	168,87	50
60-80	60,30	74,47	161,97	179,07	50
70-90	61,53	77,60	169,57	186,94	50
80-100	62,67	80,80	179,90	201,34	50
90-110	63,80	82,93	186,67		50
100-120	66,27	88,27	201,80		50
110-130	70,94	90,40	203,60		50
120-140	73,40	98,87	221,67		50

SERIE PESADA / HEAVY SERIES / LOURDE (12mm)

MEDIDA SIZE MESURE m.m.	W1	W2	W4	W5	
	ABP1	ABP2	ABP4	ABP5	
16-27	42,20	57,33	136,00		100
20-32	47,07	64,47	144,57	159,00	100
23-35	48,47	65,60	147,94		100
25-40	49,40	66,53	160,67	176,74	100
30-45	53,00	70,73	168,00	185,27	100
32-50	54,33	75,67	171,80	189,00	50
40-60	62,73	79,80	189,67	206,80	50
50-70	67,53	87,07	197,13	216,87	50
60-80	73,67	93,20	221,47	243,60	25
70-90	78,20	97,27	235,50	259,07	25
80-100	86,33	101,40	249,77	274,74	25
90-110	94,80	102,40	255,80		25
100-120	98,33	110,60	275,90	303,54	25
110-130	100,54	113,67	290,07		25
120-140	109,53	123,87	296,13	325,74	25
130-150	113,56	135,38	321,47		25
140-160	117,20	143,40	328,53	361,40	25
150-170	146,67	152,27	345,74		25
160-180	165,13	177,73	389,27	428,20	25
170-190	176,94	204,60	412,87		20
180-200	188,73	242,33	442,33	486,54	20
190-210	194,60	280,00	550,00		20
200-220	324,40	355,40	583,34		20
210-230	350,00	366,67	616,67		20
220-240	383,34	389,87	633,34		20
230-250	412,87	467,94	650,00		20
240-260	448,20	495,94	666,67		20

PRECIOS DE TARIFA / PRICE LIST / PRIX DES TARIFS / PREIS AUS TARIF - €/100 U.

CÓDIGO DE CALIDAD DEL MATERIAL UTILIZADO / QUALITY MATERIAL USED CODE

W1	- TOTALMENTE EN ACERO CINCOADO / FULLY ZINC PLATED STEEL
W2	- CINTA Y CABEZA EN ACERO INOXIDABLE A-2 Y TORNILLO EN ACERO CINCOADO / BAND & HEAD IN STAINLESS STEEL AISI 304 WITH ZINC PLATED SCREW
W4	- TOTALMENTE EN ACERO INOXIDABLE A-2 / FULLY STAINLESS STEEL AISI 304
W5	- TOTALMENTE EN ACERO INOXIDABLE A-4 / FULLY STAINLESS STEEL AISI 316

- Hose clamp in zinc plated steel.
- The head has a compact design and the tightening is compatible with several tools.
- Recommended for the industrial and agricultural sector.

MALETÍN AB. SIN FIN SERIE LIGERA (9mm) - W1

WORM HOSE CLAMP LIGHT SERIES (9mm) - W1 BRIEFCASE
MALLETTTE COLLIERS À CRÉMAILLÈRES SÉRIE LÉGÈRE (9mm) - W1
HANDKOFFER AUS SCHNECKENGEWINDESCHELLEN (9mm) - W1



W1

MEDIDA SIZE / MESURE m.m.	CANTIDAD QUANTITY QUANTITÉ	MEDIDA SIZE / MESURE m.m.	CANTIDAD QUANTITY QUANTITÉ
10-16	20	20-32	20
12-22	20	25-40	15
16-27	20	40-60	10
DESCRIPCIÓN DESCRIPTION / DESCRIPTION		MEDIDA SIZE / MESURE m.m.	CANTIDAD QUANTITY QUANTITÉ
ATORNILLADOR FLEXIBLE HEXAGONAL		SW-7	1

CÓDIGO CODE / CODE	DESCRIPCIÓN DESCRIPTION / DESCRIPTION
MABL1	MALETÍN ABL1 DE 106 PIEZAS

PRECIO TARIFA / PRICE LIST	PRECIO TARIFA / PRICE LIST
€/UNIDAD 82,25	€/100 u. 8.247,00

MALETÍN AB. SIN FIN SERIE LIGERA (9mm) - W2

WORM HOSE CLAMP LIGHT SERIES (9mm) - W2 BRIEFCASE
MALLETTTE COLLIERS À CRÉMAILLÈRES SÉRIE LÉGÈRE (9mm) - W2
HANDKOFFER AUS SCHNECKENGEWINDESCHELLEN (9mm) - W2



W2

MEDIDA SIZE / MESURE m.m.	CANTIDAD QUANTITY QUANTITÉ	MEDIDA SIZE / MESURE m.m.	CANTIDAD QUANTITY QUANTITÉ
10-16	20	20-32	20
12-22	20	25-40	15
16-27	20	40-60	10
DESCRIPCIÓN DESCRIPTION / DESCRIPTION		MEDIDA SIZE / MESURE m.m.	CANTIDAD QUANTITY QUANTITÉ
ATORNILLADOR FLEXIBLE HEXAGONAL		SW-7	1

CÓDIGO CODE / CODE	DESCRIPCIÓN DESCRIPTION / DESCRIPTION
MABL2	MALETÍN ABL2 DE 106 PIEZAS

PRECIO TARIFA / PRICE LIST	PRECIO TARIFA / PRICE LIST
€/UNIDAD 103,13	€/100 u. 10.313,00

MALETÍN AB. SIN FIN SERIE LIGERA (9mm) - W4

WORM HOSE CLAMP LIGHT SERIES (9mm) - W4 BRIEFCASE
MALLETTTE COLLIERS À CRÉMAILLÈRES SÉRIE LÉGÈRE (9mm) - W4
HANDKOFFER AUS SCHNECKENGEWINDESCHELLEN (9mm) - W4



W4

MEDIDA SIZE / MESURE m.m.	CANTIDAD QUANTITY QUANTITÉ	MEDIDA SIZE / MESURE m.m.	CANTIDAD QUANTITY QUANTITÉ
10-16	20	20-32	20
12-22	20	25-40	15
16-27	20	40-60	10
DESCRIPCIÓN DESCRIPTION / DESCRIPTION		MEDIDA SIZE / MESURE m.m.	CANTIDAD QUANTITY QUANTITÉ
ATORNILLADOR FLEXIBLE HEXAGONAL		SW-7	1

CÓDIGO CODE / CODE	DESCRIPCIÓN DESCRIPTION / DESCRIPTION
MABL4	MALETÍN ABL4 DE 106 PIEZAS

PRECIO TARIFA / PRICE LIST	PRECIO TARIFA / PRICE LIST
€/UNIDAD 171,88	€/100 u. 17.188,00

MALETÍN AB. SIN FIN SERIE LIGERA (9mm) - W5

WORM HOSE CLAMP LIGHT SERIES (9mm) - W5 BRIEFCASE
MALLETTTE COLLIERS À CRÉMAILLÈRES SÉRIE LÉGÈRE (9mm) - W5
HANDKOFFER AUS SCHNECKENGEWINDESCHELLEN (9mm) - W5



W5

MEDIDA SIZE / MESURE m.m.	CANTIDAD QUANTITY QUANTITÉ	MEDIDA SIZE / MESURE m.m.	CANTIDAD QUANTITY QUANTITÉ
10-16	20	20-32	20
12-22	20	25-40	15
16-27	20	40-60	10
DESCRIPCIÓN DESCRIPTION / DESCRIPTION		MEDIDA SIZE / MESURE m.m.	CANTIDAD QUANTITY QUANTITÉ
ATORNILLADOR FLEXIBLE HEXAGONAL		SW-7	1

CÓDIGO CODE / CODE	DESCRIPCIÓN DESCRIPTION / DESCRIPTION
MABL5	MALETÍN ABL5 DE 106 PIEZAS

PRECIO TARIFA / PRICE LIST	PRECIO TARIFA / PRICE LIST
€/UNIDAD 226,88	€/100 u. 22.688,00

ABRAZADERA SUPER

HEAVY DUTY HOSE CLAMP
 COLLIER À TOURILLONS
 GELENKBOLZENSCHLENN

W1 W2 W4 W5

- Abrazadera para la unión de mangueras y tubos con altas presiones.
- Bordes biselados para evitar daños en el tubo.
- Recomendado para uso industrial y agrícola (transporte de fluidos).
- Apriete con tuerca hexagonal.



CAJA

18mm / M5		ANCHO / WIDTH / LARGEUR: 18mm - TORNILLO / SCREW / VIS: M5				
MEDIDA SIZE MESURE m.m.	W1	W2	W4	W5		
	ABS1	ABS2	ABS4	ABS5		
17-19	98,27	146,20	265,20	308,87	100	
20-22	99,00	150,27	275,93	320,87	100	
23-25	99,67	153,48	285,13	331,07	100	
26-28	100,34	157,53	296,53	343,74	100	
29-31	101,20	162,14	307,87	356,34	100	
32-35	121,67	170,14	317,20	366,67	100	
36-39	126,00	177,80	326,80	377,34	100	
40-43	130,27	184,00	336,40	388,00	100	
44-47	134,80	188,14	345,94	398,60	100	
48-51	138,60	193,47	355,54	409,27	50	

20mm / M6		ANCHO / WIDTH / LARGEUR: 20mm - TORNILLO / SCREW / VIS: M6				
MEDIDA SIZE MESURE m.m.	W1	W2	W4	W5		
	ABS1	ABS2	ABS4	ABS5		
23-25	129,47	207,47	381,14	486,74	100	
26-28	131,27	207,87	381,87	488,00	100	
29-31	133,00	208,20	382,60	489,34	100	
32-35	134,80	208,60	383,34	490,60	100	
36-39	136,60	217,07	391,67	501,94	90	
40-43	137,00	225,80	400,34	514,20	75	
44-47	137,47	232,00	406,47	522,60	75	
48-51	138,34	239,60	413,94	532,94	70	
52-55	140,07	247,00	421,27	543,34	60	
56-59	142,47	255,14	430,94	545,00	50	
60-63	145,07	262,07	437,80	554,47	40	
64-67	162,47	293,00	476,14	593,67	50	
68-73	165,74	300,80	483,87	603,94	50	
74-79	168,67	310,34	494,07	618,07	50	
80-85	171,87	320,47	504,87	633,14	50	
86-91	175,67	332,74	524,80	656,34	50	
92-97	180,27	343,74	535,60	670,94	50	
98-103	184,34	354,34	546,47	685,67	25	
104-112	191,74	368,47	560,47	703,34	25	

25mm / M8		ANCHO / WIDTH / LARGEUR: 25mm - TORNILLO / SCREW / VIS: M8				
MEDIDA SIZE MESURE m.m.	W1	W2	W4	W5		
	ABS1	ABS2	ABS4	ABS5		
44-47	249,97	476,80	796,27	1.007,80	50	
48-51	250,73	478,27	797,74	1.009,67	48	
52-55	251,43	479,74	799,20	1.011,60	36	
56-59	252,20	481,20	800,67	1.013,54	32	
60-63	252,93	482,67	802,14	1.015,47	60	
64-67	253,63	484,14	803,60	1.017,40	60	
68-73	260,50	496,14	815,47	1.032,87	52	
74-79	265,80	505,87	825,14	1.049,34	48	
80-85	268,87	524,87	844,00	1.075,47	44	
86-91	274,10	538,14	857,00	1.094,74	36	
92-97	281,10	553,40	872,20	1.116,27	32	
98-103	291,63	574,07	892,60	1.143,20	24	
104-112	306,60	597,34	958,87	1.180,94	24	
113-121	312,53	620,74	982,07	1.213,67	20	
122-130	362,97	648,47	1.009,47	1.250,80	16	
131-139	376,74	676,40	1.037,14	1.287,54	16	
140-148	384,80	696,40	1.056,94	1.317,27	12	
149-161	442,60	818,93	1.224,74	1.508,87	8	

PRECIOS DE TARIFA / PRICE LIST / PRIX DES TARIFS / PREIS AUS TARIF - €/100 U.

ABRAZADERA SUPER

HEAVY DUTY HOSE CLAMP
 COLLIERS À TOURILLONS
 GELENKBOLZENSCHLENN



- Clamp for joining hoses and pipes with high pressures.
- Bevelled edges to avoid damage to the tube.
- Recommended for industrial and agricultural use (transport of fluids).
- Tighten with hexagonal nut



CAJA

25mm / M8

ANCHO / WIDTH / LARGEUR: 25mm - TORNILLO / SCREW / VIS: M8

MEDIDA SIZE MESURE m.m.	W1	W2	W4	W5	
	ABS 1	ABS 2	ABS 4	ABS 5	
162-174	475,27	875,13	1.280,34	1.580,34	8
175-187	492,00	910,27	1.315,14	1.630,40	8
188-200	506,74	945,07	1.349,60	1.681,94	8
201-213	525,27	986,07	1.390,14	1.739,60	5
214-226	541,87	1.023,00	1.426,67	1.793,27	5
227-239	588,40	1.094,13	1.497,07	1.875,60	5
240-255	605,87	1.131,60	1.534,14	1.929,60	5
250-265	624,07	1.172,60	1.575,47	1.982,60	5
260-275	644,20	1.200,33	1.602,87	2.022,94	5
275-290	664,34	1.245,80	1.648,67	2.087,74	5
290-305	683,74	1.291,54	1.693,94	2.152,20	5
300-315	685,74	1.295,40	1.697,74	2.172,20	5
310-325	686,94	1.335,20	1.737,87	2.228,94	5
320-335	697,07	1.358,40	1.760,80	2.260,40	5
330-345	709,27	1.388,74	1.790,94	2.304,27	5
350-365	729,00	1.442,07	1.843,67	2.382,74	5
360-375	739,00	1.468,74	1.870,07	2.421,94	5
375-390	753,14	1.509,54	1.910,40	2.482,54	5
390-405	770,34	1.552,20	1.952,60	2.544,14	5

30mm / M10

ANCHO / WIDTH / LARGEUR: 30mm - TORNILLO / SCREW / VIS: M10

MEDIDA SIZE MESURE m.m.	W1	W2	W4	W5	
	ABS 1	ABS 2	ABS 4	ABS 5	
86-91	533,94	871,64	1.138,74	1.861,80	25
92-97	543,60	893,80	1.160,54	1.897,27	25
98-103	555,34	920,80	1.186,94	1.941,27	25
104-112	569,94	950,27	1.215,74	2.011,27	25
113-121	582,80	982,27	1.247,07	2.063,40	25
122-130	601,80	1.022,54	1.286,54	2.126,74	15
131-139	623,34	1.063,40	1.326,54	2.187,07	15
140-148	637,94	1.096,80	1.358,20	2.240,07	15
149-161	682,60	1.162,27	1.425,00	2.390,20	15
162-174	724,74	1.231,74	1.492,94	2.486,40	10
175-187	746,40	1.280,94	1.541,14	2.565,74	10
188-200	767,14	1.328,80	1.588,07	2.643,60	10
201-213	792,47	1.381,27	1.639,40	2.725,07	10
214-226	811,60	1.429,00	1.686,07	2.804,60	10
227-239	847,54	1.491,27	1.747,14	2.893,47	10
240-255	867,54	1.538,94	1.803,07	2.991,14	10
250-265	889,20	1.924,87	2.263,07	3.123,54	10
260-275	902,27	1.969,80	2.307,60	3.182,54	10
275-290	921,14	2.034,54	2.671,80	3.267,27	10
290-305	938,47	2.098,34	2.435,00	3.351,47	10
300-315	946,20	2.136,87	2.473,34	3.404,00	5
310-325	962,14	2.183,54	2.519,40	3.463,60	5
320-335	979,67	2.234,80	2.569,94	3.527,94	5
330-345	997,47	2.287,00	2.621,34	3.595,27	5
350-365	1.027,40	2.374,40	2.707,40	3.706,27	5
360-375	1.046,74	2.425,87	2.757,94	3.770,67	5
375-390	1.069,94	2.497,00	2.828,20	3.862,14	5
390-405	1.092,20	2.565,47	2.895,54	3.949,54	5
405-420	1.112,27	2.629,60	2.958,74	4.032,27	5
425-440	1.138,07	2.718,07	3.046,00	4.147,27	5
440-455	1.155,47	2.782,20	3.109,27	4.231,47	5
450-465	1.169,54	2.829,20	3.155,67	4.292,40	5
465-480	1.188,27	2.894,00	3.219,47	4.376,67	5
480-495	1.214,94	2.966,74	3.291,00	4.467,87	5
495-510	1.234,54	3.034,74	3.357,87	4.556,27	5
510-525	1.260,87	3.106,54	3.428,34	4.646,14	5
525-540	1.278,27	3.169,54	3.492,27	4.730,34	5

PRECIOS DE TARIFA / PRICE LIST / PRIX DES TARIFS / PREIS AUS TARIF - €/100 U.

ABRAZADERA REFORZADA - M8 + M10

PIPE CLAMP M8 + M10
 CLAMP RENFORCÉ M8 + M10
 VERSTÄRKTKLEMM M8 + M10



- Abrazadera reforzada para la sujeción de tubos.
- Tuerca de rosca métrica soldada en la base para la sujeción de la misma.
- Instalación rápida y sencilla.

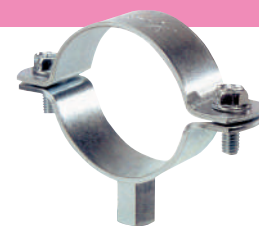

CAJA 

ABRAZADERA REFORZADA

TUERCA / NUT / ÉCROU : M8+M10

∅ TUBO ∅ PIPE ∅ TUBE m.m.	APERTURA OPENING OUVERTURE m.m.	W1	W4	W5	
		ABR	ABR2	ABR4	
18	17-20	95,13	318,47	438,27	50
22	20-25	103,33	327,80	454,14	50
28	26-30	107,93	340,60	475,87	50
35	32-36	112,53	355,87	501,47	50
40	38-45	122,80	366,47	519,34	50
48	47-51	133,00	388,67	554,67	50
54	53-58	144,80	401,67	576,80	50
60	60-64	148,87	422,67	609,27	50
70	68-72	156,07	468,07		50
75	74-80	159,60	469,80	689,34	50
84	81-86	164,20	485,20	715,40	25
90	87-92	168,33	502,67	743,20	25
100	99-105	172,40	521,34	790,60	25
110	107-112	176,47	544,74	827,20	25
115	113-118	183,67	557,07	847,94	25
125	125-130	190,00	597,60	883,40	25
140	138-142	199,53	642,60	949,14	25
150	148-152	215,33	682,67	1.022,47	25
160	159-166	253,33	725,54	1.059,07	25
180	179-184	278,67	775,40	1.133,80	25
200	200-205	304,00			25
204	198-210		1.239,34	1.664,47	25
220	215-220	372,14	1.332,87	1.796,27	25
225	223-228	426,47	1.357,87	1.831,47	25
250	249-254	451,94	1.464,20	1.981,60	25
280	279-284	487,94	1.594,94	2.162,47	25
300	299-304	513,34	1.712,00	2.275,94	25
315	314-319	535,14	1.829,20	2.379,87	25
350	349-354	569,34	1.974,94	2.585,20	25
400	399-406	643,87	2.029,20	3.007,80	25
450	449-456	791,40			25
500	499-506	901,07	2.417,14	3.430,34	25

PRECIOS DE TARIFA / PRICE LIST / PRIX DES TARIFS / PREIS AUS TARIF - €/100 U.

CÓDIGO DE CALIDAD DEL MATERIAL UTILIZADO / QUALITY MATERIAL USED CODE

- W1** - TOTALMENTE EN ACERO CINCADO / FULLY ZINC PLATED STEEL
- W2** - CINTA Y CABEZA EN ACERO INOXIDABLE A-2 Y TORNILLO EN ACERO CINCADO / BAND & HEAD IN STAINLESS STEEL AISI 304 WITH ZINC PLATED SCREW
- W4** - TOTALMENTE EN ACERO INOXIDABLE A-2 / FULLY STAINLESS STEEL AISI 304
- W5** - TOTALMENTE EN ACERO INOXIDABLE A-4 / FULLY STAINLESS STEEL AISI 316

- Reinforced clamp for holding tubes.
- Metric thread nut welded on the base to hold it.
- Quick and easy installation.



REF.: VSDR (PÁG.50)



REF.: EDRT (PÁG.67)



REF.: DRZ (PÁG.67)

ABRAZADERA REFORZADA ISOFÓNICA - M8 + M10

RUBBER PIPE CLAMP M8 + M10
 CLAMP RENFORCÉ EN CAOUTCHOUC M8 + M10
 VERSTÄRKT KLEMM M8 + M10

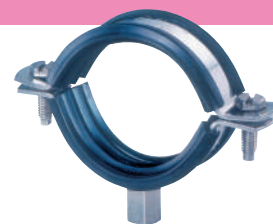

- Abrazadera reforzada para la sujeción de tubos.
- Cubierta interior en goma EPDM para evitar el daño y/o el deslizamiento del tubo.
- Tuerca de rosca métrica soldada en la base para la sujeción de la misma.



CAJA 

ABRAZADERA REFORZADA ISOFÓNICA

TUERCA / NUT / ÉCROU : M8+M10

∅ TUBO ∅ PIPE ∅ TUBE m.m.	APERTURA OPENING OUVERTURE m.m.	W1	W4	W5	
		ABIR	ABIR2	ABIR4	
18	17-20	107,33	370,00	505,94	50
22	20-25	114,80	382,87	514,14	50
28	26-30	121,40	399,67	541,20	50
35	32-36	131,27	418,20	566,80	50
40	38-45	143,67	438,87	595,94	50
48	47-51	157,73	466,14	642,00	50
54	53-58	167,60	503,27	681,40	50
60	60-64	179,20	540,34	738,20	50
70	68-72	190,73	580,22		50
75	74-80	199,80	606,87	793,40	50
84	81-86	211,40	622,87	839,47	25
90	87-92	228,13	645,34	879,34	25
100	99-105	262,60	666,34	954,07	25
110	107-112	274,20	697,87	999,54	25
115	113-118	287,87	718,87	1.015,94	25
125	125-130	331,00	774,87	1.052,74	25
140	138-142	372,93	813,34	1.127,94	25
150	148-152	388,73	859,54	1.232,34	25
160	159-166	413,87	886,14	1.277,34	25
180	179-184	457,73	953,00	1.374,54	25
200	200-205	523,53			25
204	198-210		1.395,47	1.820,54	25
220	215-220	752,00	1.498,54	1.962,00	25
225	223-228	842,00	1.529,34	2.002,94	25
250	249-254	943,80	1.647,20	2.164,67	25
280	279-284	996,47	1.792,27	2.362,80	25
300	299-304	1.015,40	1.888,34	2.491,67	25
315	314-319	1.090,60	1.971,54	2.605,27	25
350	349-354	1.316,20	2.140,27	2.833,67	25
400	399-406	1.348,13			25
450	449-456	1.489,67			25
500	499-506	1.610,73			25

PRECIOS DE TARIFA / PRICE LIST / PRIX DES TARIFS / PREIS AUS TARIF - €/100 U.

CÓDIGO DE CALIDAD DEL MATERIAL UTILIZADO / QUALITY MATERIAL USED CODE

- W1** - TOTALMENTE EN ACERO CINCADO / FULLY ZINC PLATED STEEL
- W2** - CINTA Y CABEZA EN ACERO INOXIDABLE A-2 Y TORNILLO EN ACERO CINCADO / BAND & HEAD IN STAINLESS STEEL AISI 304 WITH ZINC PLATED SCREW
- W4** - TOTALMENTE EN ACERO INOXIDABLE A-2 / FULLY STAINLESS STEEL AISI 304
- W5** - TOTALMENTE EN ACERO INOXIDABLE A-4 / FULLY STAINLESS STEEL AISI 316

- Reinforced clamp for holding tubes.
- EPDM rubber inner cover to prevent damage and / or slippage of the tube.
- Metric thread nut welded on the base to hold it.



REF.: VSDR (PÁG.50)



REF.: EDRT (PÁG.67)



REF.: DRZ (PÁG.67)

ATORNILLADOR FLEXIBLE HEXAGONAL

HEXAGONAL FLEXIBLE SCREWDRIVER / TOURNEVIS FLEXIBLE / FLEXIBLER SCHRAUBENDREHER

CÓDIGO
CODE / CODE



ATF 1

PRECIO TARIFA / PRICE LIST

PRECIO TARIFA / PRICE LIST

€/UNIDAD
12,47

€/100 U.
1.247,00



ABRAZADERA OREJA

SECURITY EAR CLAMP / COLLIER À OREILLES / OHRSCHELLEN

- Anilla en acero cincado para la unión de tubos tanto de aire como de fluidos.
- La abrazadera es inviolable una vez montada.
- Su diseño redondeado evita daños en los tubos.

W1 W4

2 OREJAS
2 EARS
2 OREILLES



COD.: A20

1 OREJA
1 EARS
1 OREILLE



COD.: A10

1 OREJA Y ANILLA
1 EARS & RING
1 OREILLE ET ANNEAU



COD.: A10A

ALICATES
PLIERS
PINCES



COD.: AAD

ALICATES AGUJERO
HOLE PLIERS
PINCES TROU



COD.: AADA

CAJA

2 OREJAS / 2 FLAPS / 2 OREILLES

MEDIDA SIZE MESURE m.m.	BANDA RANGE BANDE m.m.	W1 A20	W4 A20A2	
5-7	6	16,14	44,34	500
7-9	7	20,40	54,87	500
9-11	7	20,40	61,54	500
10-12	7	21,14		500
11-13	7	21,80	62,27	250
13-15	7	25,20	74,47	250
14-17	8	31,54	80,14	250
15-18	8	32,87	81,60	250
17-20	8	33,34	92,60	250
18-21	9	36,54	98,27	250
20-23	9	40,40	101,47	250
22-25	9	49,67	128,40	100
23-27	10	52,87		100
25-28	10	57,14		100
28-31	10	62,40		100
31-34	10	69,20		100
34-37	10	83,94		100
37-40	10	93,87		100
40-43	10	104,14		100
43-46	10	120,87		100

1 OREJA / 1 FLAP / 1 OREILLE

MEDIDA SIZE MESURE m.m.	BANDA RANGE BANDE m.m.	W1 A101	W4 A104	
7-9	6	19,34	52,94	500
8-10	6	19,34	55,14	500
9-11	6	19,34	60,80	500
10-12	6	20,07	62,74	500
11-13	6	22,20	65,67	500
12-14	7	26,54	68,87	500
13-15	7		71,54	500
14-16	7	30,34	73,54	500
16-18	7	34,87	89,47	500

1 OREJA Y ANILLA / 1 FLAP & RING / 1 OREILLE ET RONDELLE

MEDIDA SIZE MESURE m.m.	BANDA RANGE BANDE m.m.	W1 A10A1	W4 A10AA2	
7,5 - 8,5	6	44,14	78,94	250
8,0 - 9,5	6	44,14	81,60	250
9,0 - 10,5	6	44,60	88,20	250
10,0 - 11,5	6	46,60	90,94	250
10,5 - 12,5	6	48,80	95,80	250
11,5 - 13,5	7	54,67	100,94	250
13,0 - 15,3	7	58,60	107,34	250
14,0 - 16,3	7		109,27	250
15,0 - 17,3	7	65,20		250
16,0 - 18,3	7		123,00	250
17,0 - 19,3	7		125,47	250

**ALICATES ABRAZADERA OREJA
SECURITY CLAMP PLIERS / PINCES POUR COLLIER À OREILLES**

CÓDIGO CODE CODE	MODELO MODEL MODÈLE:	PRECIO TARIFA PRICE LIST PRIX TARIFS €/100 U.
AAD	SIN AGUJERO / WITHOUT HOLE / SANS TROU	2.334,00
AADA	CON AGUJERO / WITH HOLE / AVEC TROU	2.500,00

PRECIOS DE TARIFA / PRICE LIST / PRIX DES TARIFS / PREIS AUS TARIF - €/100 U.

- Zinc-plated steel ring for the union of both air and fluid pipes.
- The clamp is inviolable once assembled.
- Its rounded design prevents damage to the tubes.

ABRAZADERA ISOFÓNICA TIPO "L" - DIN 3016

RUBBER LINED P-CLIP / COLLIERS DE FIXATION AVEC CAOUTCHOUC / ROHRSCHELLEN MIT GUMMIEINLAGE

- Abrazadera de acero con cubierta interior en goma EPDM.
- Apta para la sujeción de tubo, cableado eléctrico, mangueras, etc.
- La cubierta interior protege el tubo en la instalación y evita el deslizamiento.
- Instalación rápida y sencilla con multitud de aplicaciones.



W1 **W4**

CAJA 

MEDIDA SIZE MESURE m.m.	W1 - CINCADO / ZINC PLATED			W4 - INOX. A-2 / AISI 304			
	COD.: ABLI15	COD.: ABLI20	COD.: ABLI25	COD.: ABLI215	COD.: ABLI220	COD.: ABLI225	
	BANDA / RANGE / BANDE 15 m.m. 20 m.m. 25 m.m.			BANDA / RANGE / BANDE 15 m.m. 20 m.m. 25 m.m.			
6	34,00			67,60			50
8	34,00			68,94			50
10	35,00			72,14			50
12	39,27			75,34			50
14	41,34	60,47	66,74	78,54		108,07	50
16	44,54	60,47	70,00	84,87	94,34	113,40	50
18	46,60	63,60	73,14	90,20	99,60	118,67	50
20	48,80	65,74	75,27	93,34	103,94	122,94	50
22	50,87	68,87	79,47	97,54	110,27	129,27	50
24	53,00	73,14	83,74	101,80	115,60	134,54	50
26	56,16	76,34	88,00	106,14	122,00	139,94	50
28	60,47	80,60	92,27	108,14	129,40	145,20	25
30	63,60	83,74	96,47	112,47	133,67	149,40	25
32	66,74	86,94	99,60	117,67	137,87	155,80	25
34	70,00	90,14	102,87	124,14	144,20	163,20	25
36	72,07	93,27	106,00	129,40	150,60	170,60	25
38	75,27	96,47	109,20	131,54	157,00	176,94	25
40	78,47	99,60	112,40	134,67	161,20	183,27	25
42	82,74	102,87	115,54	138,94	165,47	189,67	20
44	85,87	107,14	118,74	143,27	169,74	197,07	20
46	90,14	111,34	121,94	148,47	176,07	202,40	10
48	95,40	115,54	125,07	152,74	179,27	207,67	10
50	101,74	120,87	128,25	157,00	182,47	215,14	10

PRECIOS DE TARIFA / PRICE LIST / PRIX DES TARIFS / PREIS AUS TARIF - €/100 U.

CÓDIGO DE CALIDAD DEL MATERIAL UTILIZADO / QUALITY MATERIAL USED CODE

- W1** - TOTALMENTE EN ACERO CINCADO / FULLY ZINC PLATED STEEL
- W2** - CINTA Y CABEZA EN ACERO INOXIDABLE A-2 Y TORNILLO EN ACERO CINCADO / BAND & HEAD IN STAINLESS STEEL AISI 304 WITH ZINC PLATED SCREW
- W4** - TOTALMENTE EN ACERO INOXIDABLE A-2 / FULLY STAINLESS STEEL AISI 304
- W5** - TOTALMENTE EN ACERO INOXIDABLE A-4 / FULLY STAINLESS STEEL AISI 316

- Steel clamp with EPDM rubber inner cover.
- Suitable for tube clamping, electrical wiring, hoses, etc.
- The inner cover protects the pipe in the installation and prevents slippage.
- Quick and easy installation with many applications.

ABRAZADERA PLASTIFICADA GAS CON TORNILLO

PLASTIC GAS HOSE CLAMP WITH SCREW
 COLLIER EN PLASTIQUE GAZ AVEC VIS
 KUNSTSTOFFKLEMM GAS MIT SCHRAUBE

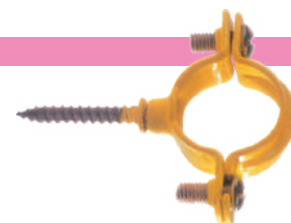

CAJA 

CÓDIGO CODE CODE	MEDIDA SIZE MESURE m.m.	APERTURA OPENING OUVERTURE m.m.		PRECIO TARIFA PRICE LIST PRIX TARIFS €100 u.
ABTPT12	12	11-12	100	45,50
ABTPT15	15	15-16	100	46,47
ABTPT18	18	17-18	100	47,35
ABTPT22	22	21-22	100	49,75
ABTPT28	28	27-28	100	52,97
ABTPT35	35	34-35	50	59,29

GRAPAS PUENTE SIMPLES

S-SHAPPED / D-SHAPPED SADDLE CLIPS
 AGRAFE SIMPLE
 BRÜCKE CLIP FÜR ROHRLEITUNG



- Grapa de sujeción para tubo redondo o manguera.
- Solución rápida y sencilla para instalaciones de tubos.



CAJA

GRAPAS PUENTE SIMPLE 1 PATA S-SHAPPED SAD. CLIPS 1 TAB / AGRAFE SIMPLE 1 PATTE

MEDIDA SIZE MESURE m.m.	BANDA RANGE BANDE m.m.	W1	W4	
		GP1P	GP1PA2	
8	15x1,2	5,40		100
10	15x1,2	5,60		100
12	15x1,2	6,67	27,07	100
14	15x1,2	8,00		100
16	15x1,2	10,54	30,80	100
18	15x1,2	11,87	34,34	100
20	15x1,2	13,14	37,20	100
22	15x1,2	14,94	40,27	100
25	15x1,2	16,60	41,87	100
26	15x1,2	18,67		100
28	15x1,2	18,94	46,20	100
32	15x1,2	21,00	50,40	100
40	15x1,2	44,34		50
42	15x1,2	45,34	62,54	50
47	16x1,5	48,34		50

GRAPAS PUENTE SIMPLE 2 PATAS D-SHAPPED SAD. 2 TABS / AGRAFE SIMPLE 2 PATTES

MEDIDA SIZE MESURE m.m.	BANDA RANGE BANDE m.m.	W1	W4	
		GP2P	GP2PA2	
8	16x1,5	11,00		100
10	16x1,5	11,60		100
12	16x1,5	12,07		100
14	16x1,5	13,07		100
16	16x1,5	14,27		100
18	16x1,5	15,54	55,80	100
20	16x1,5	17,74		100
22	16x1,5	19,40	62,80	100
25	16x1,5	23,20	66,87	100
26	16x1,5	24,54	66,87	100
28	16x1,5	25,80	66,87	100
32	16x1,5	28,80		50
40	16x1,5	42,40		50
42	16x1,5	44,40	93,27	50
47	16x1,5	49,60		50
50	16x1,5	50,00		50
63	16x1,5	57,54		50
75	20x2	58,67		50
90	20x2	64,07		50

PRECIOS DE TARIFA / PRICE LIST / PRIX DES TARIFS / PREIS AUS TARIF - €/100 U.

CÓDIGO DE CALIDAD DEL MATERIAL UTILIZADO / QUALITY MATERIAL USED CODE

W1	- TOTALMENTE EN ACERO DINCADO / FULLY ZINC PLATED STEEL
W2	- CINTA Y CABEZA EN ACERO INOXIDABLE A-2 Y TORNILLO EN ACERO DINCADO / BAND & HEAD IN STAINLESS STEEL AISI 304 WITH ZINC PLATED SCREW
W4	- TOTALMENTE EN ACERO INOXIDABLE A-2 / FULLY STAINLESS STEEL AISI 304
W5	- TOTALMENTE EN ACERO INOXIDABLE A-4 / FULLY STAINLESS STEEL AISI 316

- Clamp for round tube or hose.
- Quick and easy solution for pipe installations.

ABRAZADERA DE TUBO SIMPLE M-6

SIMPLE CLAMP M-6
 COLLIER SERRAGE M-6
 EINFACH KLEMM M-6



CAJA

CÓDIGO CODE CODE	MEDIDA SIZE MESURE			PRECIO TARIFA PRICE LIST PRIX TARIFS
	m.m.	INCH.		
ABTS610	10	1/2	100	21,35
ABTS612	12	1/4	100	21,35
ABTS615	15	-	100	22,13
ABTS616	16	3/8	100	23,07
ABTS622	22	1/2	100	25,38
ABTS626	26	3/4	100	26,79
ABTS635	35	1"	50	36,41

CARRIL PERFORADO

SLOTTED CHANNEL
GOUTTIÈRE PERFORÉ
LOCHSCHIENEN

ZN

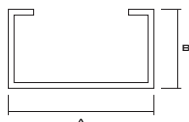

CARRIL

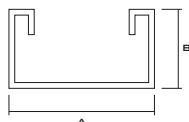

CARRILE

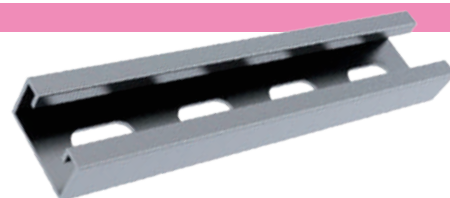

CAJA

CÓDIGO CODE CODE	MEDIDA SIZE MEASURE (AxB) m.m.	LARGO LENGTH LONGUEUR m.m.	GROSOR THICKNESS ÉPAISSEUR m.m.	CINCO	PRECIO TARIFA
					PRICE LIST PRIX TARIFS €/100 u.
CARRIL22010	20x10	2.000	1,00	1	500,00
CARRIL22718	27x18	2.000	1,25	1	773,57
CARRIL22830	28x30	2.000	1,75	1	1.562,50
CARRIL23840	38x40	2.000	2,00	1	2.131,25
CARRIL34121	41x21	3.000	1,50	1	2.934,38
CARRIL34141	41x41	3.000	1,50	1	3.843,75
CARRILE34121	41x21	3.000	2,50	1	4.509,38
CARRILE34141	41x41	3.000	2,50	1	6.403,13

SOPORTES PARA CARRIL

CHANNEL SUPPORTS
SUPPORT POUR GOUTTIÈRE
UNTERSTÜTZUNG FÜR LOCHSCHIENEN

ZN

VERTICAL
VERTICAL
VERTICAL
VERTIKAL



HORIZONTAL
HORIZONTAL
HORIZONTAL
HORIZONTAL



CAJA

CÓDIGO CODE CODE	MEDIDA SIZE MEASURE m.m.	MEDIDA CARRIL GUTTER SIZE MESURE GOUTTIÈRE m.m.	MODELO MODEL MODÈLE m.m.	CINCO	PRECIO TARIFA
					PRICE LIST PRIX TARIFS €/100 u.
SCV0816	M-8 x16	27x18	VERTICAL	1	359,38
SCV1016	M-10x16	27x18	VERTICAL	1	368,75
SCH0816	M-8x16	27x18	HORIZONTAL	1	293,75
SCH1016	M-10x16	27x18	HORIZONTAL	1	306,25

PUENTE GUÍA

CHANNEL CLAMP
COLLIER POUR GOUTTIÈRE
KLEMM FÜR LOCHSCHIENEN

ZN



CAJA

CÓDIGO CODE CODE	MEDIDA CARRIL GUTTER SIZE MESURE GOUTTIÈRE m.m.	CINCO	PRECIO TARIFA
			PRICE LIST PRIX TARIFS €/100 u.
PG2718	27x18	50	68,75
PG2830	28x30	50	84,38
PG4141	41x41	50	93,16

SOPORTE PARA CARRIL PERFORADO

CHANNEL SUPPORT
SUPPORT POUR GOUTTIÈRE PERFORÉ
UNTERSTÜTZUNG FÜR LOCHSCHIENEN

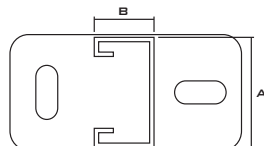

ZN

CAJA

CÓDIGO CODE CODE	MEDIDA SIZE MESURE (AxB) m.m.	LARGO LENGTH LONGUEUR m.m.		CINCADO	
				PRECIO TARIFA PRICE LIST PRIX TARIFS	€/100 u.
SCP27180200	27x18	200	10	505,14	
SCP27180300	27x18	300	10	523,10	
SCP38400300	38x40	300	10	845,57	
SCP38400400	38x40	400	10	1.033,19	
SCP38400500	38x40	500	10	1.222,00	
SCP38400600	38x40	600	10	1.410,75	
SCP41210300	41x21	300	10	642,82	
SCP41210400	41x21	400	10	747,69	
SCP41410200	41x41	200	10	638,07	
SCP41410300	41x41	300	10	816,07	
SCP41410400	41x41	400	10	992,63	
SCP41410600	41x41	600	10	2.118,75	

TUERCAS PARA CARRIL PERFORADO

CHANNEL NUTS / ÉCROU POUR GOUTTIÈRE PERFORÉ / MUTTER FÜR LOCHSCHIENEN

ZN

PLANA
FLAT
PLATE
GLATT



ESTRIADA
GROOVED
CANNELE
GERIPPT



MUELLE
SPRING
RESSORT
SPRUNGFEDER



CAJA

CÓDIGO CODE CODE	MÉTRICA METRICS MÉTRIQUE m.m.	CARRIL GUTTER GOUTTIÈRE m.m.	MODELO MODEL MODÈLE m.m.		CINCADO	
					PRECIO TARIFA PRICE LIST PRIX TARIFS	€/100 u.
CARRIL2006	M-6	20 / 25	PLANA	100	21,38	
CARRIL2008	M-8	20 / 25	PLANA	100	21,38	
CARRIL2706	M-6	25 / 27	PLANA	100	21,38	
CARRIL2708	M-8	25 / 27	PLANA	100	21,38	
CARRIL2710	M-10	25 / 27	PLANA	100	21,38	
CARRIL3808	M-8	38	PLANA	100	39,68	
CARRIL3810	M-10	38	PLANA	100	39,68	
CARRIL4108	M-8	41	ESTRIADA	100	44,70	
CARRIL4110	M-10	41	ESTRIADA	100	48,10	
CARRIL4112	M-12	41	ESTRIADA	100	48,10	
TCM1308	M-8	41x21	MUELLE	100	52,10	
TCM1310	M-10	41x21	MUELLE	100	52,10	
TCM1312	M-12	41x21	MUELLE	100	52,10	
TCM3808	M-8	41x41	MUELLE	100	52,10	
TCM3810	M-10	41x41	MUELLE	100	52,10	
TCM3812	M-12	41x41	MUELLE	100	52,10	

TORNILLOS PARA CARRIL PERFORADO

HAMMER HEAD BOLTS FOR CHANNELS
VIS POUR GOUTTIÈRE PERFORÉ
SCHRAUBEN FÜR LOCHSCHIENEN

ZN



CAJA

CÓDIGO CODE CODE	MEDIDA SIZE MESURE m.m.	ANCHO CARRIL GUTTER WIDTH LARGEUR GOUTTIÈRE m.m.	MODELO MODEL MODÈLE m.m.	CINCO	PRECIO TARIFA
					PRICE LIST PRIX TARIFS €/100 u.
TC2706020	M-6x20	27	PLANO	100	45,69
TC2708030	M-8x30	27	PLANO	100	63,50
TC3808030	M-8x30	38	PLANO	100	84,16
TC3810030	M-10x30	38	PLANO	100	103,34
TC4108040	M-8x40	41	ESTRIADO	100	103,38
TC4110040	M-10x40	41	ESTRIADO	100	109,32

ESCUADRAS PERFORADAS

HOLE CORNER ANGLES
CARRÉS POUR GOUTTIÈRE
SQUARE FÜR LOCHSCHIENEN

ZN



CAJA

CÓDIGO CODE CODE	ÁNGULO ANGLE ANGLE m.m.	CINCO	PRECIO TARIFA
			PRICE LIST PRIX TARIFS €/100 u.
EP045	45°	100	85,63
EP090	90°	100	85,63
EP180	180°	100	85,63

NUEVO PRODUCTO / NEW PRODUCT / NOUVEAU PRODUIT

MORDAZA PARA VIGA

BEAM FIXER
PINCE DE FIXATION
KLEMMER FÜR STAHLRÄGER

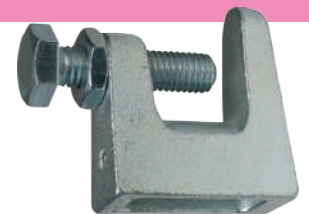
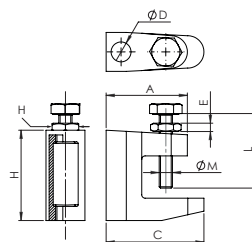

CAJA

CÓDIGO CODE CODE	MEDIDA SIZE MESURE D m.m.	MODELO MODEL MODEL	TORNILLO SCREW VIS MxL m.m.	TUERCA NUT ÉCROU FxE m.m.	H m.m.	C m.m.	A m.m.	CINCO	PRECIO TARIFA
									PRICE LIST PRIX TARIFS €/100 u.
MORDAZAM08	M-8	MÉTRICO	M8x35	13x4	37	37,5	35	50	360,94
MORDAZAM10	M-10	MÉTRICO	M10x40	16x5	42	44	41	50	426,57
MORDAZAM12	M-12	MÉTRICO	M10x45	16x5	54,5	59	49	50	525,00
MORDAZAP09	Ø9	PASANTE	M8x35	13x4	36	38,5	35	50	360,94
MORDAZAP11	Ø11	PASANTE	M10x40	16x5	42	44	41	50	426,57
MORDAZAP13	Ø13	PASANTE	M10x45	16x5	54,5	59	48	50	462,13

* TORNILLO DIN 933 8.8 CINCADO, TUERCA DIN 936 [8] CINCADA, MORDAZA HIERRO FUNDIDO / ZINC PLATED SCREW DIN 933 8.8, ZINC PLATED NUT DIN 936 [8], CAST IRON BEAM FIXER

ROLLOS DE CINTA NO PERFORADA

NOT PERFORATED ROLL TAPE
 ROULEAU EN BANDE NON PERFORÉES

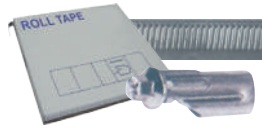

RNBG / CNBG





RNCP / CNCP



RNBD / CNBD

W1 **W2** **W4**

CAJA

MEDIDA SIZE MESURE m.m.	CONTENIDO / CONTENT / CONTENU		RNBG / CNBG	
	 m.		W1 CINCADO	W2 CINCADO / INOX. A-2
12x0,8	30	-	RNBG / CNBG	RNBD / CNBD
12	-	50	13.183,34	18.280,00
			339,00	380,20

MEDIDA SIZE MESURE m.m.	CONTENIDO / CONTENT / CONTENU		RNCP / CNCP	
	 m.		W1 CINCADO	W2 CINCADO / INOX. A-2
9	30	-	RNCP2 / CNCP2	RNCP4 / CNCP4
12	30	-	-	6.441,88
9	-	50	-	9.040,63
12	-	50	-	124,65
			-	104,99

MEDIDA SIZE MESURE m.m.	CONTENIDO / CONTENT / CONTENU		RNBD / CNBD	
	 m.		W1 CINCADO	W2 CINCADO / INOX. A-2
9,5	30	-	RNBD / CNBD	
13	30	-	-	4.489,39
15,8	30	-	-	8.050,63
19	30	-	-	9.738,45
9,5	-	100	-	11.371,26
13	-	100	-	41,25
15,8	-	100	-	55,01
19	-	100	-	82,50
			-	96,26

PRECIOS DE TARIFA / PRICE LIST / PRIX DES TARIFS / PREIS AUS TARIF - €/100 U.



CINTA PERFORADA EN BLISTER

PERFORATED BAND IN BLISTER
 BANDE PERFORÉE EN BLISTER

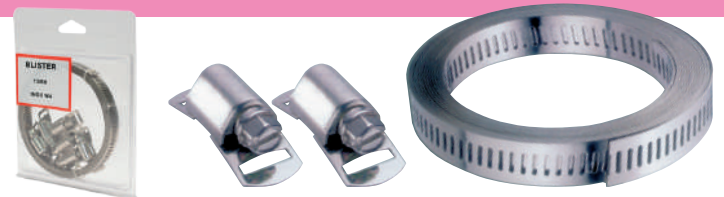
W2



BLISTERS

CÓDIGO CODE CODE	GROSOR THICKNESS ÉPAISSEUR m.m.	CONTENIDO / CONTENT / CONTENU		PRECIO TARIFA PRICE LIST / PRIX TARIFS
		 m.		
BCP08	8	3	8	€100 u. 1.031,25
BCP13	13	3	6	1.375,01

BASE RECTANGULAR PARA ABRAZADERA INOXIDABLE A-4

STAINLESS STEEL AISI 316 RECTANGULAR BASE WITH NUT
 BASE RECTANGULAIRE POUR CLAMP EN ACIER INOX. A-4
 RECHTECKIGEN GRUND MIT MUTTER - EDELSTAHL A-4

CAJA

CÓDIGO CODE CODE	MÉTRICA METRICS MÉTRIQUE m.m.		INOX. A-4	
			PRECIO TARIFA PRICE LIST PRIX TARIFS	
BRA	M-8 / M-10	1	€100 u.	326,57



BRIDA METÁLICA CINTA INOX. A-2

CABLE TIE - STAINLESS STEEL AISI 304
COLLIER EN ACIER INOX. A-2
KABELBINDER - EDELSTAHL A-2



**INOX
A2**

BOLSA

INOX. A-2

CÓDIGO CODE CODE	MEDIDA SIZE MEASURE m.m.		PRECIO TARIFA PRICE LIST PRIX TARIFS €/100 U.
BMA2046200	4,6x200	100	38,20
BMA2046300	4,6x300	100	39,94
BMA2046350	4,6x350	100	40,80
BMA2079400	7,9x400	50	67,40
BMA2079500	7,9x500	50	72,80
BMA2079550	7,9x550	50	76,34
BMA2130600	13x600	25	155,27
BMA2130700	13x700	25	173,00

CINTA PERFORADA ONDULADA

WAVY PERFORATED ROLL TAPE
RUBAN PERFORÉ ONDULÉ
WELLENF LOCHBAND



W1 W4

CAJA

ANCHO WIDTH LARGEUR m.m.	GROSOR THICKNESS ÉPAISSEUR m.m.	C m.m.	D m.m.			W1 CINCADO - ZINC PLATED	W4 INOX. A-2 - AISI 304
						CPG	CPG4
12	0,8	14	5	10	10	719,07	2.406,26
17	0,8	20	7	10	10	866,67	2.750,01

PRECIOS DE TARIFA / PRICE LIST / PRIX DES TARIFS / PREIS AUS TARIF - €/100 U.

CINTA PERFORADA RECTA

STRAIGHT PERFORATED ROLL TAPE
RUBAN PERFORÉ DROITE
GERADEN LOCHBAND

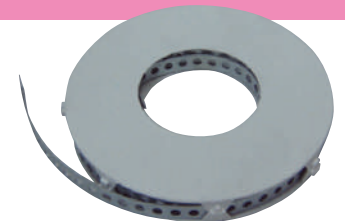

W1

CAJA

ANCHO WIDTH LARGEUR m.m.	GROSOR THICKNESS ÉPAISSEUR m.m.	C m.m.	D m.m.			W1 CINCADO - ZINC PLATED
						CPR
12	0,8	14	5	10	10	794,07
17	0,8	20	7	10	10	1.010,63
25	1,0	25	9	10	10	1.588,13

PRECIOS DE TARIFA / PRICE LIST / PRIX DES TARIFS / PREIS AUS TARIF - €/100 U.

SENSOR ARO - GANCHO CINCADO

TURNBUCKLES WITH EYE AND HOOK ZINC PLATED
 TENDEURS ANNEAU ET CROCHET EN ACIER ZINGUÉ
 SPANNSCHLÖSSER MIT HAKEN UND ÖSE VERZINKT

ZN

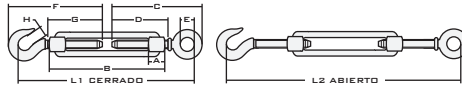

CAJA

ACERO Fe 430 B

CÓDIGO CODE CODE	MÉTRICA METRICS MÉTRIQUE	CMA. Kg.	A m.m.	B m.m.	C m.m.	D m.m.	E m.m.	F m.m.	G m.m.	H m.m.	L1 m.m.	L2 m.m.	PESO WEIGHT POIDS Kg.	PRECIO TARIFA PRICE LIST PRIX TARIFS €/100 u.
TAGZ05	M 5	50	9	79	59	40	8	62	40	6	120	170	0,05	109,38
TAGZ06	M 6	75	10	88	74	50	10	76	50	8,5	143	205	0,06	124,13
TAGZ08	M 8	165	12	110	80	52	11	89	52	10	162	237	0,12	162,97
TAGZ10	M10	235	15	130	97	60	14	103	62	12	196	277	0,24	243,32
TAGZ12	M12	320	18	140	106	67	17	121	65	16	223	310	0,38	392,88
TAGZ14	M14	420	20	170	126	83	18	144	82	16	262	378	0,56	508,38
TAGZ16	M16	530	22,5	190	160	97	23	172	105	16,5	296	420	0,94	819,22
TAGZ20	M20	730	30	220	190	116	25	185	110	17,5	342	475	1,48	1.444,22
TAGZ22	M22	1.120	33	242	200	120	30	216	125	23	382	505	2,18	2.053,60
TAGZ24	M24	1.550	39	255	210	125	34	225	135	23	418	542	2,73	2.468,75

BLISTERS

ACERO Fe 430 B

CÓDIGO CODE CODE	MÉTRICA METRICS MÉTRIQUE	PRECIO TARIFA PRICE LIST PRIX TARIFS €/BLISTER
BTAGZ05	M 5	8,69
BTAGZ06	M 6	8,69
BTAGZ08	M 8	8,69

**PEDIDO MÍNIMO 1 EMBALAJE
 MINIMUM ORDER 1 PACKAGING**

SENSOR GANCHO - GANCHO CINCADO

TURNBUCKLES WITH TWO HOOKS ZINC PLATED
 TENDEURS À DEUX CROCHETS EN ACIER ZINGUÉ
 SPANNSCHLÖSSER MIT ZWEI HAKEN

ZN

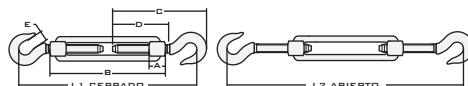

CAJA

ACERO Fe 430 B

CÓDIGO CODE CODE	MÉTRICA METRICS MÉTRIQUE	CMA. Kg.	A m.m.	B m.m.	C m.m.	D m.m.	E m.m.	L1 m.m.	L2 m.m.	PESO WEIGHT POIDS Kg.	PRECIO TARIFA PRICE LIST PRIX TARIFS €/100 u.
TGGZ05	M 5	50	9	79	62	40	6	122	173	0,05	109,38
TGGZ06	M 6	75	10	88	76	50	8,5	145	209	0,07	124,13
TGGZ08	M 8	165	12	110	89	52	10	162	245	0,12	162,97
TGGZ10	M10	235	15	130	103	62	12	204	284	0,27	243,32
TGGZ12	M12	320	18	140	121	65	16	236	327	0,42	392,88
TGGZ14 *	M14	420	20	170	144	82	16	284	395	0,62	580,38
TGGZ16	M16	530	22,5	190	172	105	16,5	315	436	0,95	819,22
TGGZ20	M20	730	30	220	185	110	17,5	345	482	1,54	1.444,22
TGGZ22 *	M22	1.120	33	242	216	125	23	385	507	2,25	2.111,57
TGGZ24 *	M24	1.550	39	255	225	135	23	420	552	2,81	2.658,66

* MEDIDAS SOLO DISPONIBLES POR ENCARGO / MEASURES ONLY AVAILABLE ON REQUEST / MESURES DISPONIBLES UNIQUEMENT SUR DEMANDE

CMA.: CARGA MÁXIMA ADMISIBLE, PA.: PAR DE APRIETE. / CMA.: MAXIMUM ALLOWABLE LOAD, PA.: TORQUE / CMA.: CHARGE MAXIMALE ADMISIBLE, PA.: COUPLE DE SERRAGE

SENSOR ARO - ARO CINCADO

TURNBUCKLES WITH TWO EYES ZINC PLATED
 TENDEURS À DEUX ANNEAUX EN ACIER ZINGUÉ
 SPANNSCHLÖSSER MIT ZWEI ÖSEN

ZN

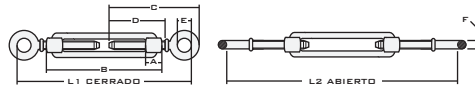

CAJA 

ACERO Fe 430 B

CÓDIGO CODE CODE	MÉTRICA METRICS MÉTRIQUE	CMA. Kg.	A m.m.	B m.m.	C m.m.	D m.m.	E m.m.	F m.m.	L1 m.m.	L2 m.m.	PESO WEIGHT POIDS		PRECIO TARIFA
													PRICE LIST
													PRIX TARIFS
													€/100 u.
TAAZ05	M 5	140	9	79	59	40	8	4	122	175	0,04	100	109,38
TAAZ06	M 6	225	10	88	74	50	10	4	140	203	0,06	50	124,13
TAAZ08	M 8	410	12	110	80	52	11	5	157	226	0,15	30	162,97
TAAZ10	M10	650	15	130	97	60	14	6,5	182	260	0,21	20	243,32
TAAZ12	M12	930	18	140	106	67	17	8	228	297	0,34	10	392,88
TAAZ14*	M14	1.330	20	170	126	83	18	8,5	245	365	0,50	40	580,38
TAAZ16	M16	1.770	22,5	190	160	97	23	13	280	412	0,93	10	819,22
TAAZ20	M20	2.200	30	220	190	116	25	14	324	450	1,42	10	1.444,22
TAAZ22*	M22	3.300	33	242	200	120	30	16	365	495	2,11	5	2.111,57
TAAZ24*	M24	3.920	39	255	210	125	34	17	402	532	2,65	5	2.658,66

SENSOR HORQUILLA - HORQUILLA CINCADO

TURNBUCKLES WITH TWO JAWS ZINC PLATED
 TENDEURS À DEUX CHAPES EN ACIER ZINGUÉ
 SPANNSCHLÖSSER MIT ZWEI GABELN

ZN

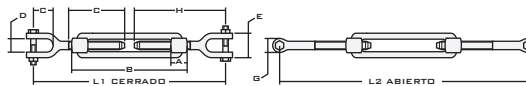

CAJA 

ACERO Fe 430 B

CÓDIGO CODE CODE	MÉTRICA METRICS MÉTRIQUE	CMA. Kg.	A m.m.	B m.m.	C m.m.	D m.m.	E m.m.	F m.m.	G m.m.	H m.m.	L1 m.m.	L2 m.m.	TLLO. SCREW VIS	PESO WEIGHT POIDS		PRECIO TARIFA
																PRICE LIST
																PRIX TARIFS
																€/100 u.
THHZ06	M 6	230	12	110	56	12,5	25	21	17	88	190	265	6x25	0,09	30	547,57
THHZ08	M 8	440	15	110	56	12,5	25	24	19	88	190	265	8x35	0,22	15	677,71
THHZ10	M10	440	18	125	62	12,5	30	29	20	105	215	290	8x35	0,33	10	935,13
THHZ12	M12	600	21	125	62	12,5	30	29	22	105	215	290	10x40	0,58	10	1.329,35
THHZ14*	M14	600	23	140	76	17,5	40	38	29	132	275	350	10x45	1,04	10	2.000,00
THHZ16	M16	800	27	170	100	20	44	42	32	145	315	425	12x50	1,21	15	2.385,27
THHZ20	M20	1.650	34	200	100	22	50	45	36	170	360	475	16x60	2,14	8	4.083,34
THHZ22*	M22	2.600	36	220	105	23	53	50	38	174	360	495	20x70	3,37	5	5.228,60
THHZ24	M24	2.600	39	255	123	25	58	56	40	200	420	585	20x75	3,77	5	7.863,00

SENSOR VARILLA - VARILLA DIN 1481 CINCADO

TURNBUCKLES WITH STUBENDS DIN 1481 ZINC PLATED
 TENDEURS À SOUDER DIN 1481 EN ACIER ZINGUÉ
 SPANNSCHLÖSSER MIT ZWEI ANSCHWEISSENDEN DIN 1481

ZN

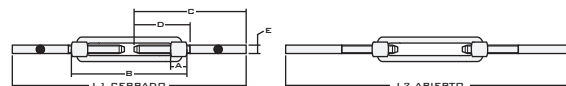

CAJA 

ACERO Fe 430 B

CÓDIGO CODE CODE	MÉTRICA METRICS MÉTRIQUE	A m.m.	B m.m.	C m.m.	D m.m.	E m.m.	L1 m.m.	L2 m.m.	CMA. Kg.	PESO WEIGHT POIDS		PRECIO TARIFA	
												PRICE LIST	
													PRIX TARIFS
													€/100 u.
TVVZ08	M 8	12	110	120	65	7,05	240	338	410	0,14	150	269,25	
TVVZ10	M10	15	130	150	75	8,80	300	415	650	0,27	80	342,87	
TVVZ12	M12	18	140	150	75	10,70	300	422	930	0,40	60	492,82	
TVVZ14*	M14	20	170	180	90	12,70	360	510	1.320	0,60	30	739,07	
TVVZ16	M16	22,5	190	200	100	14,50	400	567	1.770	0,95	25	1.153,88	
TVVZ20	M20	30	220	220	120	18,70	440	630	2.700	1,64	15	2.026,47	
TVVZ24	M24	39	255	260	150	22,50	520	736	3.920	2,83	8	3.319,72	
TVVZ30*	M30	45	255	260	175	27,50	520	730	6.250	4,45	5	5.312,28	

ANILLA DE ELEVACIÓN MACHO DIN 580 CINCADA

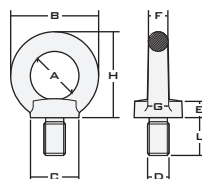
 LIFTING EYE BOLTS DIN 580 ZINC PLATED
 ANNEAU DE LEVAGE DIN 580 EN ACIER ZINGUÉ
 RINGSCHRAUBEN DIN 580

ZN
CAJA
ACERO C 15 E

CÓDIGO CODE CODE	MÉTRICA METRICS MÉTRIQUE	CMA. 0°	CMA. 45°	CMA. 90°	A	B	C	E	F	G	H	L	PESO WEIGHT POIDS	PRECIO TARIFA PRICE LIST PRIX TARIFS	
															(D) m.m.
580Z06	M 6	90	60	45	20	36	20	6	8	10	36	13	0,06	200	109,38
580Z08	M 8	140	100	70	20	36	20	6	8	10	36	13	0,06	200	109,38
580Z10	M10	230	170	115	25	45	25	8	10	12	45	17	0,11	200	170,57
580Z12	M12	340	240	170	30	54	30	10	12	14	53	20,5	0,17	100	252,25
580Z14	M14	500	350	250	30	54	30	10	12	14	53	20,5	0,17	100	259,66
580Z16	M16	700	500	350	35	63	35	12	14	16	62	27	0,31	50	366,10
580Z18	M18	930	650	465	35	63	35	12	14	16	62	27	0,48	50	427,10
580Z20	M20	1.200	860	600	40	72	40	14	16	19	71	30	0,48	25	558,07
580Z22	M22	1.500	1.050	750	40	72	40	14	16	19	71	30	0,48	25	573,69
580Z24	M24	1.800	1.290	900	50	90	50	18	20	24	90	36	0,90	15	1.158,50
580Z27	M27	2.500	1.830	1.250	54	98	62	20	22	26	99	40	1,25	10	1.814,75
580Z30	M30	3.200	2.300	1.600	60	108	65	22	24	28	109	45	1,70	10	2.053,60

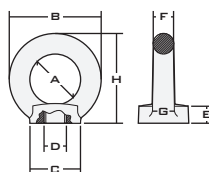
ANILLA DE ELEVACIÓN HEMBRA DIN 582 CINCADA

 EYE NUTS DIN 582 ZINC PLATED
 ANNEAU DE LEVAGE DIN 582 EN ACIER ZINGUÉ
 RINGMUTTERN DIN 582

ZN
CAJA
ACERO C 15 E

CÓDIGO CODE CODE	MÉTRICA METRICS MÉTRIQUE	CMA. 0°	CMA. 45°	CMA. 90°	A	B	C	E	F	G	H	PESO WEIGHT POIDS	PRECIO TARIFA PRICE LIST PRIX TARIFS	
														(D) m.m.
582Z06	M 6	90	60	45	20	36	20	8,5	8	10	36	0,06	200	109,38
582Z08	M 8	140	100	70	20	36	20	8,5	8	10	36	0,06	200	109,38
582Z10	M10	230	170	115	25	45	25	10	10	12	45	0,10	200	170,57
582Z12	M12	340	240	170	30	54	30	11	12	14	53	0,17	100	252,25
582Z14	M14	500	350	250	30	54	30	11	12	14	53	0,15	100	256,25
582Z16	M16	700	500	350	35	63	35	13	14	16	62	0,26	50	366,10
582Z20	M20	1.200	860	600	40	72	40	16	16	19	71	0,41	25	558,07
582Z22*	M22	1.500	1.050	750	40	72	40	16	16	19	71	0,36	25	617,82
582Z24	M24	1.800	1.290	900	50	90	50	20	20	24	90	0,75	15	1.158,50
582Z27*	M27	2.500	1.830	1.250	54	98	62	22	22	26	99	0,80	10	1.814,75
582Z30	M30	3.200	2.300	1.600	60	108	65	25	24	28	109	1,40	10	2.196,44

PRENSACABLES SIMPLE CINCADO

SIMPLEX WIRE ROPE CLIPS
SERRE-CÂBLES SIMPLEX
SIMPLEX DRAHTSEILKLEMMEN

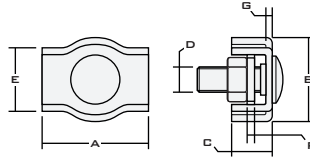
ZN



CAJA

CÓDIGO CODE CODE	MEDIDA SIZE MESURE	A	B	C	D	E	F	G	PESO WEIGHT POIDS	PRECIO TARIFA PRICE LIST PRIX TARIFS
PCZ02	2	17,5	12	5	M 4	7,5	1	1	0,02	16,47
PCZ03	3	17,5	15	6,5	M 4	10	1,5	1,5	0,02	17,47
PCZ04	4	22	18	7,5	M 5	12	1,5	1,5	0,04	25,00
PCZ05	5	24	20	8,5	M 5	14	1,5	1,5	0,04	27,70
PCZ06	6	30	23	10	M 6	17	1,5	1,5	0,05	32,84
PCZ08	8	36	30	14	M 8	22	2	2	0,05	66,17

AUTOSERVICIO

CÓDIGO CODE CODE	MEDIDA SIZE MESURE	PRECIO TARIFA PRICE LIST PRIX TARIFS
BFPCZ02	2	25 12 7,95
BFPCZ03	3	20 12 6,55
BFPCZ04	4	15 12 9,38

AUTOSERVICIO

CÓDIGO CODE CODE	MEDIDA SIZE MESURE	PRECIO TARIFA PRICE LIST PRIX TARIFS
BFPCZ05	5	10 12 10,24
BFPCZ06	6	8 12 8,83
BFPCZ08	8	5 12 12,61

PEDIDO MÍNIMO 1 EMBALAJE / MINIMUM ORDER 1 PACKAGING
COMMANDE MINIMALE 1 EMBALLAGE / MINDESTBESTELLMENGE 1 VERPACKUNG

PRENSACABLES DOBLE CINCADO

DUPLEX WIRE ROPE CLIPS
SERRE-CÂBLES DUPLEX
DUPLEX DRAHTSEILKLEMMEN

ZN

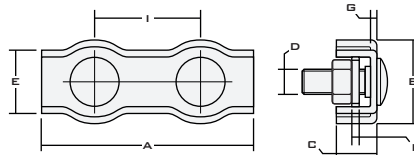

CAJA

CÓDIGO CODE CODE	MEDIDA SIZE MESURE	A	B	C	D	E	F	G	I	PESO WEIGHT POIDS	PRECIO TARIFA PRICE LIST PRIX TARIFS
PCDZ02	2	38	12	5	M 4	7,5	1	1	20,5	0,010	23,72
PCDZ03	3	38	15	6,5	M 4	10	1,5	1,5	20,5	0,015	28,57
PCDZ04	4	47	18	7,5	M 5	12	1,5	1,5	25	0,025	41,85
PCDZ05	5	51	20	8,5	M 5	14	1,5	1,5	27	0,035	46,04
PCDZ06	6	63	23	10	M 6	17	1,5	1,5	33	0,050	67,73
PCDZ08	8	76	30	14	M 8	22	2	2	42	0,100	126,95

GUARDACABOS DIN 6899-A CINCADO

THIMBLES DIN 6899-A ZINC PLATED
COSSES COEUR DIN 6899-A EN ACIER ZINGUÉ
KAUSCHEN DIN 6899-A

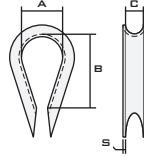

ZN

CAJA

ACERO Fe 360 B

CÓDIGO CODE CODE	MEDIDA SIZE MESURE ($\varnothing \times C$) m.m.	A m.m.	B m.m.	S m.m.	PESO WEIGHT POIDS Kg.		PRECIO TARIFA PRICE LIST PRIX TARIFS €/100 u.
6899A04	4x5	13	28,5	0,75	0,004	200	23,69
6899A05	5x6	14	30,0	1,00	0,006	200	26,82
6899A06	6x7	15	33,0	1,00	0,008	200	30,38
6899A07	7x8	16	35,0	1,25	0,010	100	31,94
6899A08	8x9	18	39,0	1,25	0,016	100	42,74
6899A09	9x10	20	43,0	1,25	0,020	50	43,25
6899A10	10x11	22	47,5	1,50	0,030	50	55,15
6899A11	11x12	24	51,5	1,50	0,037	25	67,87
6899A13	13x14	28	61,0	1,80	0,072	25	98,25
6899A16	16x18	35	78,0	2,50	0,179	15	218,36
6899A18	18x20	40	86,5	2,50	0,270	10	442,00
6899A20	20x22	44	95,0	2,50	0,355	10	461,90

AUTOSERVICIO

ACERO Fe 360 B

CÓDIGO CODE CODE	MEDIDA SIZE MESURE m.m.			PRECIO TARIFA PRICE LIST PRIX TARIFS €/BOLSA
BF6899A05	5x6	15	12	6,75
BF6899A06	6x7	12	12	6,50
BF6899A07	7x8	10	12	6,10
BF6899A08	8x9	8	12	7,44

**PEDIDO MÍNIMO 1 EMBALAJE
MINIMUM ORDER 1 PACKAGING**

GUARDACABOS DIN 6899-B GALVANIZADO

THIMBLES DIN 6899-B HOT DIP GALVANIZED
COSSES COEUR DIN 6899-B GALVANISÉ
KAUSCHEN DIN 6899-B

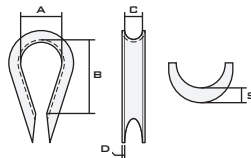

ZN

CAJA

ACERO Fe 360 B

CÓDIGO CODE CODE	MEDIDA SIZE MESURE ($\varnothing \times C$) m.m.	A m.m.	B m.m.	D m.m.	S m.m.	PESO WEIGHT POIDS Kg.		PRECIO TARIFA PRICE LIST PRIX TARIFS €/100 u.
6899B09*	9x10	24	38	1,25	3,1	0,047	100	81,94
6899B11*	11x12	28	45	1,50	3,3	0,068	50	109,54
6899B13*	13x14	32	51	1,75	3,3	0,100	50	160,72
6899B16*	16x17	38	61	2,00	4,7	0,180	25	280,97
6899B18*	18x20	45	72	2,25	5,7	0,290	10	392,88
6899B20*	20x22	50	80	2,50	5,7	0,320	10	506,72
6899B24*	24x26	62	99	3,50	6,8	0,590	10	816,67
6899B26*	26x28	70	112	3,50	8,0	0,800	20	1.178,60
6899B32*	30x32	80	152	3,50	8,0	1,230	15	1.533,50

***HASTA AGOTAR EXISTENCIAS**

MOSQUETÓN BOMBERO DIN 5299 CINCADO

SNAP HOOKS DIN 5299 ZINC PLATED
 MOUSQUETONS DIN 5299 EN ACIER ZINGUÉ
 KARABINERHAKEN DIN 5299

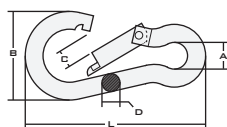

ZN

CAJA

CÓDIGO CODE CODE	MEDIDA SIZE MEASURE (DxL) m.m.	CMA. Kg.	A m.m.	B m.m.	C m.m.	PESO WEIGHT POIDS Kg.	PRECIO TARIFA PRICE LIST PRIX TARIFS €/100 u.
MBZ040	4x40	30	7	14	6	0,01	47,35
MBZ050	5x50	100	8	15	7	0,02	49,85
MBZ060	6x60	120	9	17	8	0,02	60,91
MBZ070	7x70	180	10	19	8	0,04	80,00
MBZ080	8x80	230	12	23	10	0,07	97,64
MBZ090	9x90	250	12	24	10	0,09	134,00
MBZ100	10x100	350	15	29	11	0,13	159,54
MBZ120	11x120	380	18	36	16	0,19	226,82
MBZ140	12x140	400	20	40	19	0,20	287,97

AUTOSERVICIO

CÓDIGO CODE CODE	MEDIDA SIZE MEASURE (DxL) m.m.	PRECIO TARIFA PRICE LIST PRIX TARIFS €/BOLSA		
		ACERO Fe 360 B		
BFMBZ40	4x40	15	12	12,60
BFMBZ50	5x50	10	12	9,00
BFMBZ60	6x60	6	12	7,04
BFMBZ80	8x80	4	12	7,25

BLISTERS

CÓDIGO CODE CODE	MEDIDA SIZE MEASURE (DxL) m.m.	PRECIO TARIFA PRICE LIST PRIX TARIFS €/BLISTER		
		ACERO Fe 360 B		
BMBZ40	4x40	1	12	2,09
BMBZ50	5x50	1	12	2,09
BMBZ60	6x60	1	12	2,09
BMBZ80	8x80	1	12	2,89

PEDIDO MÍNIMO 1 EMBALAJE / MINIMUM ORDER 1 PACKAGING
 COMMANDE MINIMALE 1 EMBALLAGE / MINDESTBESTELLMENGE 1 VERPACKUNG

MOSQUETÓN BOMBERO CON SEGURO CINCADO

SNAP HOOKS WITH SAFETY SCREW ZINC PLATED / MOUSQUETONS À VIS DE SECURITE EN ACIER ZINGUÉ
 KARABINERHAKEN MIT SCHRAUBSICHERUNG

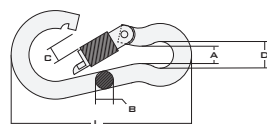

ZN

CAJA

CÓDIGO CODE CODE	MEDIDA SIZE MEASURE (BxL) m.m.	CMA. Kg.	A m.m.	C m.m.	D m.m.	PESO WEIGHT POIDS Kg.	PRECIO TARIFA PRICE LIST PRIX TARIFS €/100 u.
MBSZ060	6x60	130	7	6	10	0,028	77,98
MBSZ070	7x70	180	8	7	11	0,043	109,00
MBSZ080	8x80	230	9	8	13	0,066	113,23
MBSZ090	9x90	250	10	8	13	0,092	175,00
MBSZ100	10x100	350	11	10	16	0,129	180,82
MBSZ120	11x120	450	12	15	19	0,186	265,21

AUTOSERVICIO

CÓDIGO CODE CODE	MEDIDA SIZE MEASURE (DxL) m.m.	PRECIO TARIFA PRICE LIST PRIX TARIFS €/BOLSA		
		CINCADO		
BFMBSZ060	6x60	6	12	8,63
BFMBSZ080	8x80	4	12	8,72

PEDIDO MÍNIMO 1 EMBALAJE
 MINIMUM ORDER 1 PACKAGING

SUJETACABLES DIN 741 CINCADO

WIRE ROPE CLIPS CAST IRON DIN 741 - ZINC PLATED
 SERRE CÂBLES EN FONTE DIN 741 EN ACIER ZINGUÉ
 DRAHTSEILKLEMMEN DIN 741 VERZINKT

ZN

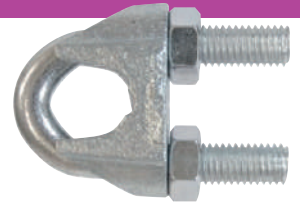
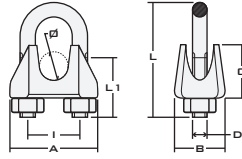



CAJA

HIERRO COLADO

CÓDIGO CODE CODE	MEDIDA SIZE MESURE	CABLE ROPE CABLE	A	B	C	D	I	L	L1	PESO WEIGHT POIDS		PRECIO TARIFA PRICE LIST PRIX TARIFS
	m.m.	m.m.	m.m.	m.m.	m.m.	m.m.	m.m.	m.m.	m.m.	Kg.		€/100 u.
741Z03	3	3	21	10	10	M 4	9	20	12	0,01	100	11,44
741Z05	5	5	24	11	10	M 5	11	24	13	0,02	100	15,27
741Z06	6	6,5	26	12	11	M 5	13	28	15	0,02	100	18,88
741Z08	8	8	30	14	15	M 6	16	34	19	0,02	50	28,10
741Z10	10	10	37	20	19	M 8	20	42	22	0,06	50	52,25
741Z12	12	13	44	25	23	M10	25	55	30	0,11	25	100,67
741Z14	14	14	46	25	25	M10	27	57	30	0,12	25	107,17
741Z16	16	16	52	28	28	M12	30	63	33	0,15	20	151,82
741Z19	19	19	58	32	34	M12	34	75	38	0,23	20	196,44
741Z22	22	22	64	35	35	M14	38	85	44	0,27	20	305,82
741Z26	26	26	68	38	38	M14	42	95	45	0,30	20	355,31
741Z30	30	30	80	40	45	M16	50	110	50	0,50	20	508,28



AUTOSERVICIO

HIERRO COLADO

CÓDIGO CODE CODE	MEDIDA SIZE MESURE			PRECIO TARIFA PRICE LIST PRIX TARIFS
	m.m.			€/BOLSA
BF741Z03	3	15	12	3,85
BF741Z05	5	10	12	3,57
BF741Z06	6	8	12	3,41
BF741Z08	8	6	12	3,79
BF741Z10	10	4	12	3,57

BLISTERS

HIERRO COLADO

CÓDIGO CODE CODE	MEDIDA SIZE MESURE			PRECIO TARIFA PRICE LIST PRIX TARIFS
	m.m.			€/BLISTER
B741Z03	3	4	12	2,09
B741Z05	5	4	12	2,09
B741Z06	6	4	12	2,09
B741Z08	8	2	12	2,09
B741Z10	10	1	12	2,09

PEDIDO MÍNIMO 1 EMBALAJE / MINIMUM ORDER 1 PACKAGING
 COMMANDE MINIMALE 1 EMBALLAGE / MINDESTBESTELLMENGE 1 VERPACKUNG

MALLA RÁPIDA CINCADA

QUICK LINKS ZINC PLATED
 MAILLONS RAPIDES EN ACIER ZINGUÉ
 KETTENNOTGLIEDER

ZN

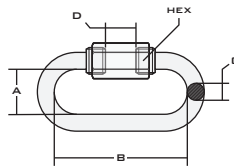

CAJA

ACERO Fe 360 B

CÓDIGO CODE CODE	MEDIDA SIZE MESURE	A	B	D	HEXÁGONO HEXAGON HEXAGONE	PESO WEIGHT POIDS		PRECIO TARIFA PRICE LIST PRIX TARIFS
	(C) m.m.	m.m.	m.m.	m.m.	m.m.	Kg.		€/100 u.
MRZ04	4	12	33	5	8	0,01	100	44,66
MRZ05	5	13	40	6,5	9	0,02	100	56,72
MRZ06	6	15	46	9	11	0,03	100	70,57
MRZ08	8	17,5	58	9,5	14	0,08	50	125,24
MRZ09	9	19	62	10	15	0,11	50	164,53
MRZ10	10	20,5	69	13	17	0,15	25	207,60
MRZ12	12	23,5	80,5	14,5	19	0,23	20	358,19
MRZ14	14	27	97	16	22	0,35	10	719,45
MRZ16	16	29,5	113	21	24	0,45	5	1.091,22

MOSQUETÓN GIRATORIO CINCADO

SIMPLEX HOOKS ZINC PLATED
MOSQUETONS AVEC TOURET EN ACIER ZINGUÉ
SIMPLEXHAKEN

ZN

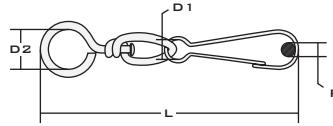

CAJA

CÓDIGO CODE CODE	MEDIDA SIZE MESURE m.m.	F m.m.	D1 m.m.	D2 m.m.	L m.m.	PESO WEIGHT POIDS Kg.	CUBIC BOX ICONE	CINCADO	
								PRECIO TARIFA PRICE LIST PRIX TARIFS €/100 u.	
MGZ030	30	4,5	6	8	30/50	0,005	50	20,85	
MGZ040	40	5,5	7	10	40/67	0,009	50	28,98	
MGZ050	50	6,5	9	11	50/83	0,014	50	35,38	
MGZ060	60	7,5	10	13	60/97	0,023	50	50,61	
MGZ080	80	10	12	17	80/123	0,050	30	88,42	
MGZ100	100	11	14	19	100/146	0,086	30	151,75	

MOSQUETÓN GANCHO GIRATORIO NIQUELADO

NICKEL SNAP HOOKS
MOSQUETONS AU NICKEL
KARABINERHAKEN

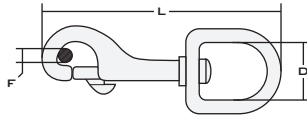

CAJA

CÓDIGO CODE CODE	MEDIDA SIZE MESURE (D) m.m.	L m.m.	F m.m.	PESO WEIGHT POIDS Kg.	CUBIC BOX ICONE	NIQUELADO	
						PRECIO TARIFA PRICE LIST PRIX TARIFS €/100 u.	
MGBN13	13	73	8	0,028	50	117,97	
MGBN16	16	78	8	0,030	50	145,60	
MGBN20	20	82	8	0,032	20	158,88	
MGBN22	22	90	8	0,043	10	220,54	
MGBN25	25	93	8	0,042	10	223,84	

GRILLETE GIRATORIO NIQUELADO

NICKEL SWIVELS
EMERILLONS AU NICKEL
WIRBEL

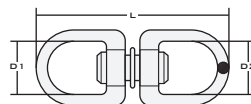

CAJA

CÓDIGO CODE CODE	MEDIDA SIZE MESURE (D1xD2) m.m.	L m.m.	CUBIC BOX ICONE	NIQUELADO	
				PRECIO TARIFA PRICE LIST PRIX TARIFS €/100 u.	
GZ13	13x13	50	100	140,19	
GZ16	16x16	60	100	181,18	
GZ20	20x20	65	50	183,69	
GZ25	25x25	78	50	252,40	

AUTOSERVICIO

CÓDIGO CODE CODE	MEDIDA SIZE MESURE (D1xD2) m.m.	CUBIC BOX ICONE		NIQUELADO	
		PRECIO TARIFA PRICE LIST PRIX TARIFS €/BOLSA			
BFGZ13	13x13	8	12	17,79	
BFGZ16	16x16	5	12	14,38	
BFGZ20	20x20	4	12	13,16	
BFGZ25	25x25	3	12	12,13	

BLISTERS

CÓDIGO CODE CODE	MEDIDA SIZE MESURE (D1xD2) m.m.	CUBIC BOX ICONE		NIQUELADO	
		PRECIO TARIFA PRICE LIST PRIX TARIFS €/BLISTER			
BGZ13	13x13	1	12	2,89	
BGZ16	16x16	1	12	2,89	

PEDIDO MÍNIMO 1 EMBALAJE / MINIMUM ORDER 1 PACKAGING
COMMANDE MINIMALE 1 EMBALLAGE / MINDESTBESTELLMENGE 1 VERPACKUNG

GRILLETE RECTO CINCO

DEE SHACKLES ZINC PLATED
MANILLES DROITES EN ACIER ZINGUÉ
GERADE SCHÄKEL VERZINKT

ZN

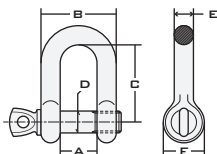

CAJA

CÓDIGO CODE CODE	MEDIDA SIZE MEASURE (D) m.m.	CMA. Kg.	A m.m.	B m.m.	C m.m.	D m.m.	E m.m.	F m.m.	PESO WEIGHT POIDS Kg.	PRECIO TARIFA PRICE LIST PRIX TARIFS €/100 u.	ACERO Fe 430 B
GRZ05	5	70	10	20	21	5	5	11	0,020	100	56,25
GRZ06	6	100	13	25	28	6	6	14	0,030	100	59,38
GRZ08	8	250	16	32	36	8	8	18	0,070	50	89,32
GRZ10	10	400	19	39	43	10	10	20	0,130	30	130,63
GRZ12	12	630	25	49	57	12	12	28	0,220	15	192,88
GRZ14	14	750	28	56	64	14	14	30	0,310	50	302,40
GRZ16	16	1.000	32	64	72	16	16	33	0,380	30	479,94
GRZ18	18	1.300	37	70	74	18	18	33,5	0,730	20	598,22
GRZ20	20	1.600	38	78	86	20	20	40	0,939	10	754,10
GRZ22	22	2.000	44	88	91	22	22	50	1,322	4	1.184,72
GRZ24	24	2.500	48,5	97	99	24	24	47,5	2,071	4	1.738,85
GRZ28	28	3.150	57	113	129	28	28	68	2,879	2	2.575,91
GRZ32	32	4.000	64	128	143	32	32	73	3,171	2	3.924,13

AUTOSERVICIO

CÓDIGO CODE CODE	MEDIDA SIZE MEASURE (D) m.m.	PRECIO TARIFA PRICE LIST PRIX TARIFS €/BOLSA	ACERO Fe 430 B	
			8	12
BFGRZ05	5	7,47	8	12
BFGRZ06	6	6,60	6	12
BFGRZ08	8	7,13	4	12

BLISTERS

CÓDIGO CODE CODE	MEDIDA SIZE MEASURE (D) m.m.	PRECIO TARIFA PRICE LIST PRIX TARIFS €/BLISTER	ACERO Fe 430 B	
			3	12
BGRZ05	5	2,89	3	12
BGRZ06	6	2,89	2	12
BGRZ08	8	2,89	1	12
BGRZ10	10	2,89	1	12

PEDIDO MÍNIMO 1 EMBALAJE / MINIMUM ORDER 1 PACKAGING
COMMANDE MINIMALE 1 EMBALLAGE / MINDESTBESTELLMENGE 1 VERPACKUNG

GRILLETE RECTO ALTA RESISTENCIA

ALLOY STEEL DEE SHACKLES WITH SCREW PIN
MANILLES DROITES ACIER ALLIÉ
HOCHFESTE GERADE SCHÄKEL

ZN

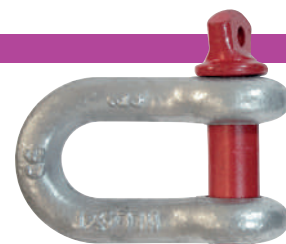
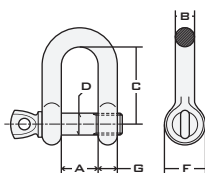

CAJA

CÓDIGO CODE CODE	MEDIDA SIZE MEASURE m.m.	MEDIDA SIZE MEASURE INCH.	CMA. TN.	A m.m.	B m.m.	C m.m.	D m.m.	PESO WEIGHT POIDS Kg.	PRECIO TARIFA PRICE LIST PRIX TARIFS €/100 u.	ACERO ALTA RESISTENCIA
GRAR05	5	3/16"	0,33	9,5	5	19,0	6,0	0,020	10	141,10
GRAR06	6	1/4"	0,50	11,9	6,4	22,4	7,9	0,050	10	157,60
GRAR08	8	5/16"	0,75	13,5	7,9	26,2	9,7	0,077	10	186,19
GRAR10	10	3/8"	1,00	16,8	9,7	31,8	11,2	0,127	10	258,94
GRAR12	12	1/2"	2,00	20,6	12,7	41,4	16,0	0,268	10	457,60
GRAR16	16	5/8"	3,25	26,9	16,0	50,8	19,1	0,568	10	758,94
GRAR20	20	3/4"	4,75	31,8	19,1	60,5	22,4	1,194	10	1.263,41
GRAR22	22	7/8"	6,50	36,6	25,4	71,3	25,4	1,435	10	1.772,35

GRILLETE LIRA CINCADO

BOW SHACKLES ZINC PLATED
 MANILLES LYRES EN ACIER ZINGUÉ
 HERZFÖRMIGE SCHÄKEL VERZINKT

ZN

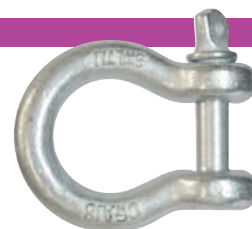
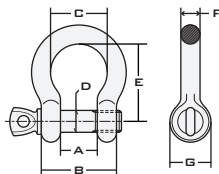

CAJA

ACERO Fe 430 B

CÓDIGO CODE CODE	MEDIDA SIZE MEASURE (D) m.m.	CMA. Kg.	A m.m.	B m.m.	C m.m.	E m.m.	F m.m.	G m.m.	PESO WEIGHT POIDS Kg.	PRECIO TARIFA PRICE LIST PRIX TARIFS €/100 u.
GLZ05	5	80	10	20	16	21	5	11	0,020	56,25
GLZ06	6	100	13	25	20	28	6	14	0,030	63,41
GLZ08	8	200	16	32	24	36	8	18	0,080	96,94
GLZ10	10	300	19	39	32	43	10	20	0,130	150,74
GLZ12	12	500	25	49	38	57	12	28	0,230	238,02
GLZ14	14	600	28	56	44	64	14	30	0,360	349,05
GLZ16	16	800	32	64	50	72	16	32	0,370	568,53
GLZ20	20	1.100	38	78	66	86	20	40	1,003	857,16
GLZ22	22	1.500	44	88	74	91	22	50	1,428	1.271,00
GLZ24	24	2.000	48,5	95	68	108	24	47	2,045	1.906,25

AUTOSERVICIO

ACERO Fe 430 B

CÓDIGO CODE CODE	MEDIDA SIZE MEASURE (D) m.m.	PRECIO TARIFA PRICE LIST PRIX TARIFS €/BOLSA
BFGLZ05	5	7,07
BFGLZ06	6	5,57
BFGLZ08	8	7,38

PEDIDO MÍNIMO 1 EMBALAJE
 MINIMUM ORDER 1 PACKAGING

GRILLETE LIRA ALTA RESISTENCIA

ALLOY STEEL BOW SHACKLES WITH SCREW PIN
 MANILLES LYRES EN ACIER ALLIÉ
 HOCHFESTE HERZFÖRMIGE SCHÄKEL

ZN

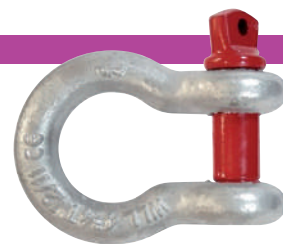
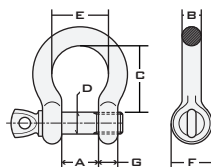

CAJA

ACERO ALTA RESISTENCIA

CÓDIGO CODE CODE	MEDIDA SIZE MEASURE m.m.	MEDIDA SIZE MEASURE INCH.	CMA. TN.	A m.m.	B m.m.	C m.m.	D m.m.	E m.m.	F m.m.	G m.m.	PESO WEIGHT POIDS Kg.	PRECIO TARIFA PRICE LIST PRIX TARIFS €/100 u.
GLAR06	6	1/4"	0,50	11,9	6,4	28,7	7,9	19,8	16	6	0,045	162,97
GLAR08	8	5/16"	0,75	13,5	7,9	31,0	9,7	21,3	19	8	0,086	190,19
GLAR10	10	3/8"	1,00	16,8	9,7	36,6	11,2	26,2	23	10	0,141	265,63
GLAR11	11	7/16"	1,50	19,1	11,2	42,9	12,7	29,5	27	11	0,173	373,25
GLAR12	12	1/2"	2,00	20,6	12,7	47,8	16	33,3	30	13	0,327	491,10
GLAR16	16	5/8"	3,25	26,9	16,0	60,5	19,1	42,9	39	16	0,622	886,19
GLAR20	20	3/4"	4,75	31,8	19,1	71,4	22,4	50,8	47	19	1,067	1.325,91
GLAR24	24	1"	8,50	42,9	25,4	95,3	28,7	68,3	54	22	2,284	2.779,04

GRILLETE RECTO ALTA RESISTENCIA CON TORNILLO

ALLOY STEEL DEE SHACKLES WITH BOLT
MANILLES DROITES ACIER ALLIÉ AVEC BULLON
HOCHFESTE GERADE SCHÄKEL MIT BOLZEN

ZN

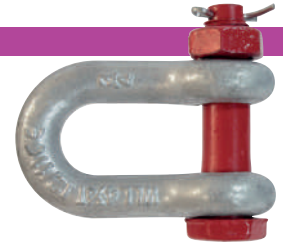
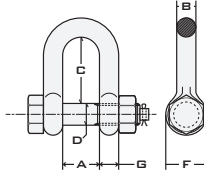

CAJA

ACERO ALTA RESISTENCIA

CÓDIGO CODE CODE	MEDIDA SIZE MESURE		CMA.	A	B	C	D	F	G	PESO WEIGHT POIDS	PRECIO TARIFA PRICE LIST PRIX TARIFS
	m.m.	INCH.									
GRART10	10	3/8"	1,00	16,8	9,7	31,0	11,2	23	10	0,150	10 309,50
GRART12	12	1/2"	2,00	20,6	12,7	41,4	16,0	30	13	0,341	10 564,75
GRART16	16	5/8"	3,25	26,9	16,0	50,8	19,1	39	16	0,667	10 926,35
GRART20	20	3/4"	4,75	31,8	19,1	60,5	22,4	47	19	1,144	10 1.370,57

GRILLETE LIRA ALTA RESISTENCIA CON TORNILLO

ALLOY STEEL BOW SHACKLES WITH BOLT
MANILLES LYRES EN ACIER ALLIÉ AVEC BOULLON
HOCHFESTE HERZFÖRMIGE SCHÄKEL MIT BOLZEN

ZN

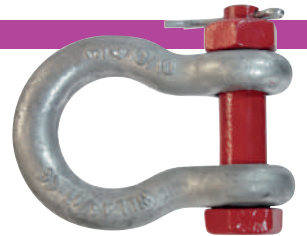
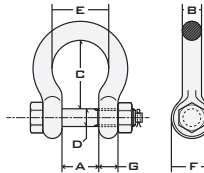

CAJA

ACERO ALTA RESISTENCIA

CÓDIGO CODE CODE	MEDIDA SIZE MESURE		CMA.	A	B	C	D	E	F	G	PESO WEIGHT POIDS	PRECIO TARIFA PRICE LIST PRIX TARIFS
	m.m.	INCH.										
GLART06	6	1/4"	0,50	11,9	6,4	28,7	7,9	19,8	16	6	0,050	10 185,29
GLART08	8	5/16"	0,75	13,5	7,9	31,0	9,7	21,3	19	8	0,100	10 214,30
GLART10	10	3/8"	1,00	16,8	9,7	36,6	11,2	26,2	23	10	0,150	10 319,22
GLART11	11	7/16"	1,50	19,1	11,2	42,9	12,7	29,5	27	11	0,222	10 419,66
GLART12	12	1/2"	2,00	20,6	12,7	47,8	16,0	33,3	30	13	0,359	10 573,69
GLART16	16	5/8"	3,25	26,9	16,0	60,5	19,1	42,9	39	16	0,763	10 979,94
GLART20	20	3/4"	4,75	31,8	19,1	71,4	22,4	50,8	47	19	1,235	10 1.437,50

GRILLETE GIRATORIO CADENA

CHAIN SWIVELS
EMERILLONS CHAÎNE
EINFACHES AUFHÄNGEGLEID

ZN

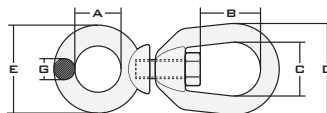

CAJA

ACERO Fe 430 B

CÓDIGO CODE CODE	MEDIDA SIZE MESURE		A	B	C	D	E	G	PESO WEIGHT POIDS	PRECIO TARIFA PRICE LIST PRIX TARIFS
	m.m.	m.m.								
GGC06	6	15,8	17,5	19	31,8	28,5	6,4	0,064	50	387,20
GGC08	8	19	20,6	25,4	38,9	35	7,9	0,120	50	466,67
GGC10	10	25,4	23,9	31,8	50,8	44,5	9,7	0,232	30	702,57
GGC12	12	31,8	33,3	38,1	63,5	57,2	12,7	0,458	30	1.135,90

GANCHO DE ELEVACIÓN CON SEGURO - GRADO 40

CARBON STEEL EYE HOOKS WITH LATCH
CROCHETS DE LEVAGE EN ACIER CARBONE AVEC LINGUET
HAKEN KOHLENSTOFFSTAHL MIT SICHERUNG

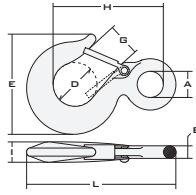

CAJA

CÓDIGO CODE CODE	CMA.	A	B	D	E	G	H	I	L	PESO WEIGHT POIDS	PRECIO TARIFA PRICE LIST PRIX TARIFS	ACERO C 40	
												KG.	€/100 u.
GESA08	0,8	19	10	30	30	21,5	80	15	110	0,26	50	562,50	
GESA10	1,0	23	12	32	32	23	93	17,5	125	0,35	50	741,10	
GESA16	1,6	27	13	35	35	23	103	20,5	142	0,62	30	1.147,35	
GESA20	2,0	30	16	38	38	24	117	22	165	0,93	25	1.411,86	
GESA32	3,2	38	19	46	125	26,5	145	28,5	204	1,73	10	2.667,44	

GANCHO DE ELEVACIÓN CON SEGURO GIRATORIO - GRADO 40

CARBON STEEL REVOLVING HOOKS WITH LATCH
CROCHETS A EMERILLON EN ACIER CARBONE AVEC LINGUET
LASTHAKEN KOHLENSTOFFSTAHL MIT SICHERUNG

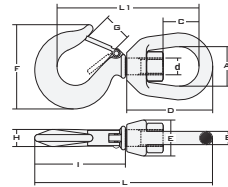

CAJA

CÓDIGO CODE CODE	CMA.	A	B	C	D	E	F	G	H	I	L	L1	d	PESO WEIGHT POIDS	PRECIO TARIFA PRICE LIST PRIX TARIFS	ACERO C 40	
																KG.	€/100 u.
GESGA10	1,0	38	13	34	82	34	81	27	26	86	170	135,5	M16	0,77	30	1.473,44	
GESGA20	2,0	50	18	47	110	48	104	32	21,5	106	219	173	M20	1,51	15	2.606,25	
GESGA32	3,2	57	20	55	127	54	125	38	28,5	133	262	205	M22	2,48	5	4.350,00	

TRINCAJE

LASHING SYSTEMS / SYSTÈMES D'ARRIMAGE / VERANKERUNGSSYSTEM



SISTEMA DE AMARRE PARA ELEVACIÓN, CON ESTRUCTURA EN POLIÉSTER, BAJA ELONGACIÓN Y TRATAMIENTO ANTIFRICCIÓN PARA RESISTIR EL DESGASTE Y LA ABRASIÓN. TENSOR GALVANIZADO PARA UNA MAYOR DURABILIDAD!
PRODUCIDO SEGÚN LA NORMA DIN EN 12195-2.

HIGH QUALITY LOAD RESTRAINT ASSEMBLIES, HIGHLY DRAWN POLYESTER WEBBING WITH LOW ELONGATION AND EQUIPMENT FOR CHAFE AND ABRASION RESISTANCE. GALVANIZED RATCHET FOR LONGER LIFE SERVICE!
PRODUCED ACCORDING TO DIN EN 12195-2.

SYSTÈME D'ARRIMAGE POUR LE LEVAGE, AVEC UNE STRUCTURE EN POLYESTER, FAIBLE ALLONGEMENT ET TRAITEMENT ANTIUSURE RÉSISTANT AU FROTTEMENT ET À L'ABRASION. RATCHET GALVANISÉ POUR UNE DURÉE DE VIE SUPÉRIEURE!
PRODUITS CONFORMÉMENT À LA NORME DIN EN 12195-2.

VERANKERUNGSSYSTEM ZUR HEBUNG, MIT POLYESTER STRUKTUR, KURZE VERLÄNGERUNG UND EINRICHTUNGEN ZUM SCHUTZ VOR ABREIBEN UND ABSCHABEN. HALTEVORRICHTUNG AUS ZINK ZUR LÄNGEREN LEBENSDAUER!
DER DIN EN 12195-2 KONFORM ERSCHAFFEN.

INSTRUCCIONES DE USO PARA TRINCAJE

OPERATING INSTRUCTIONS FOR WEB LASHINGS

INSTRUCTIONS D'UTILISATION DES SYSTÈMES D'ARRIMAGE



TRINCAJE CON GANCHO CERRADO / LASHING SYSTEM WITH PROFILE HOOK / SYSTÈME D'ARRIMAGE AVEC CROCHET PROFILÉ

CÓDIGO CODE CODE	LC.		STF. daN	LARGO LENGTH LONGUEUR mt.	COLOR COLOR COULEUR		PRECIO TARIFA PRICE LIST PRIX TARIFS €/UNIDAD.
TGC1			250	4		1	11,43
TGC2			200	6		1	15,57
TGC4			250	8		1	32,86
TGC5			250	8		1	36,44

TRINCAJE CON GANCHO ABIERTO / LASHING SYSTEM WITH CLAW HOOK / SYSTÈME D'ARRIMAGE AVEC CROCHET À GRIFE

CÓDIGO CODE CODE	LC.		STF. daN	LARGO LENGTH LONGUEUR mt.	COLOR COLOR COULEUR		PRECIO TARIFA PRICE LIST PRIX TARIFS €/UNIDAD.
TGA2			200	6		1	15,58
TGA4			250	8		1	33,21
TGA5			250	8		1	35,76

ADVERTENCIAS DE SEGURIDAD / SAFETY WARNINGS / AVERTISSEMENTS DE SÉCURITÉ / SICHERHEITSHINWEISE

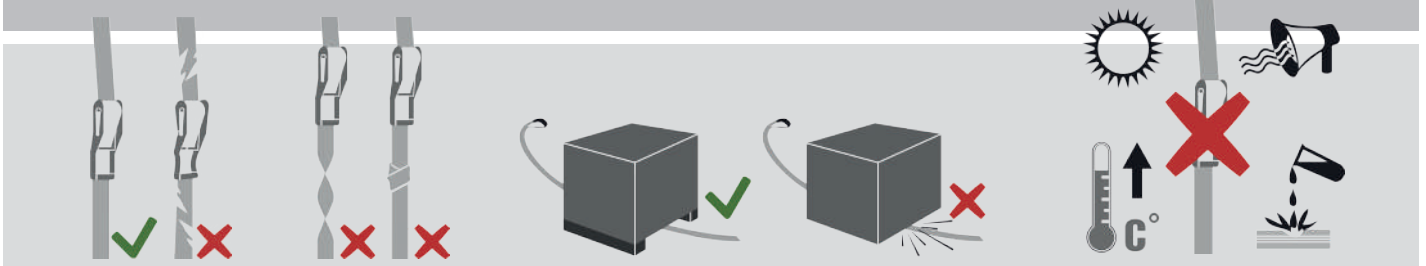

ESLINGA PLANA CON GAZAS

EYESLINGS, TWO PLYS / SANGLES DE LEVAGE À BOUCLE, DEUX PLYURES / ÖSEFÖRMIGE SCHLINGEN



ESLINGAS DE ALTA CALIDAD PARA ELEVACIÓN, FABRICADAS EN POLIESTER. FORMA ESTABILIZADA, ELABORADAS Y TERMINADAS CON ALARGAMIENTO. PRODUCIDO SEGÚN LA NORMA DIN EN 1492-1. FACTOR DE SEGURIDAD 7. CÓDIGO DE COLOR SEGÚN LOS ESTÁNDARES EUROPEOS. REGULACIÓN MÁQUINA EU CE89392 CEE II A.







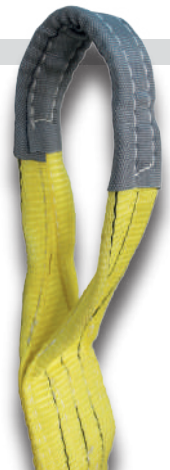

HIGH QUALITY EYESLINGS FOR LIFTING PURPOSE, MADE OF WOVEN PES, FORM-STABILIZED, DRAWN AND FINISHED, WITH LOW ELONGATION. PRODUCED ACCORDING TO DIN EN 1492-1. SAFETY FACTOR 7. COLOR-CODE ACCORDING TO EUROPEAN STANDARD. EU- MACHINE REGULATION CE 89392 CEE II A.

SANGLES DE LEVAGE À BOUCLE DE GRANDE QUALITÉ, EN POLYESTER PES, STABILISÉES DANS LA FORME, DANS LE DESSIN ET LA FINITION, AVEC UN FAIBLE ALLONGEMENT. PRODUITES CONFORMÉMENT À LA NORME DIN EN 1492-1. FACTEUR DE SÉCURITÉ 7. CODE COULEUR EN FONCTION DES STANDARDS EUROPÉENS. RÉGLAGE MACHINE EU CE 89392 CEE II A.

ÖSEFÖRMIGE SCHLINGEN HOHER HEBEQUALITÄT AUS PES POLYESTER, IN DER FORM, IN DER ZEICHNUNG UND IM FERTIGDREHEN MIT KURZER VERLÄNGERUNG STABILISIERT. DER DIN EN 1492-1 KONFORM ERSCHAFFEN. SICHERHEITSAKTOR 7. FARBKODE GEMÄSS DEN EUROPÄISCHEN STANDARDS. EU REGULIERUNG DER MASCHINE EU 89392 EWG II A.

**ESLINGA CON
REFUERZO
ESTÁNDAR**
LOOP WITH
STANDARD
REINFORCEMENT
BOUCLE AVEC
REINFORCEMENT
STANDARD
ÖSE MIT
STANDARD
VERSTÄRKUNG



CÓDIGO CODE CODE	CMA. TN.	OJAL LOOP BOUCLE m.m.	COLOR COLOR COULEUR	LONGITUD / LENGTH / LONGUEUR							
				1MT.	2MT.	3MT.	4MT.	5MT.	6MT.	8MT.	10MT.
SLO1	1	200x15		7,24	10,18	13,00	15,90	*	*	*	*
SLO2	2	300x30		10,54	16,21	21,84	27,50	36,18	47,89	*	*
SLO3	3	350x30		15,99	24,38	33,94	42,00	51,24	64,64	85,00	*
SLO4	4	425x40		*	*	52,96	59,91	74,20	102,43	135,29	*
SLO5	5	500x50		*	*	66,96	83,34	102,00	132,34	168,77	247,34
SLO6	6	550x60			*	*	117,10	144,39	171,24	206,86	251,67
SLO8	8	600x80			*	*	*	191,29	232,00	285,99	444,81
SLO10	10	750x100			*	*	*	261,91	305,34	402,29	487,13

PRECIOS DE TARIFA / PRICE LIST / PRIX DES TARIFS / PREIS AUS TARIF - €/UNIDAD

ADVERTENCIAS DE SEGURIDAD / SAFETY WARNINGS / AVERTISSEMENTS DE SÉCURITÉ / SICHERHEITSHINWEISE

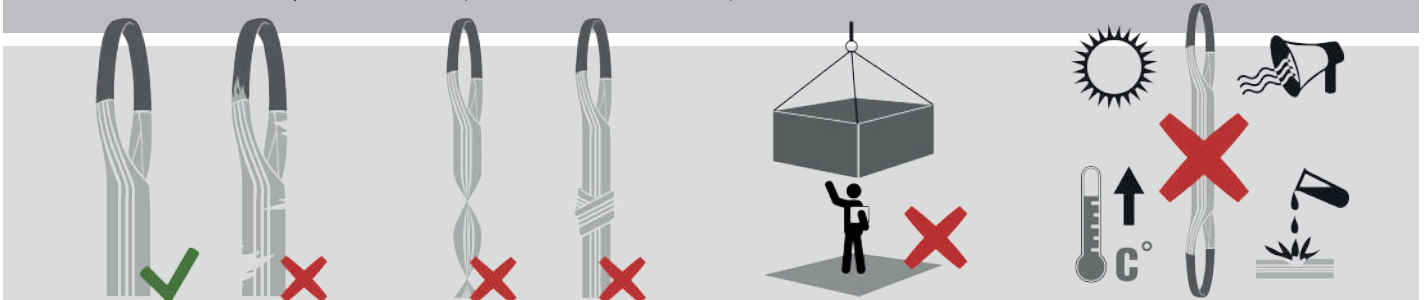

ESLINGA TUBULAR SIN FIN

ROUNDSLINGS WITH SINGLE COVER / SANGLES RONDES AVEC GAINÉ UNIQUE / RUNDE SCHLINGEN











ESLINGAS PARA ELEVACIÓN, FABRICADAS EN POLIESTER, CON VAINA ÚNICA RESISTENTE A LA ABRASIÓN. CARGA MÁXIMA EN KG. IMPRESA EN LA VAINA. PRODUCIDO SEGÚN LA NORMA DIN EN 1492-2. FACTOR DE SEGURIDAD 7. CÓDIGO DE COLOR SEGÚN LOS ESTÁNDARES EUROPEOS. REGULACIÓN MÁQUINA EU CE89392 CEE II A.

ROUNDSLINGS FOR LIFTING PURPOSE WITH ABRASION RESISTANT SINGLE COVER, WORKING LOAD LIMIT PRINTED ON THE COVER. MADE ACCORDING TO DIN EN 1492-2. SAFETY FACTOR 7. COLOR-CODE ACCORDING TO EUROPEAN STANDARD. EU MACHINE REGULATION CE 89392 CEE II A.

SANGLES RONDES DE LEVAGE, AVEC GAINÉ UNIQUE RÉSISTANTE À L'ABRASION, WLL IMPRIMÉ SUR LA GAINÉ. PRODUITES CONFORMÉMENT À LA NORME DIN EN 1492-2. FACTEUR DE SÉCURITÉ 7. CODE COULEUR EN FONCTION DES STANDARDS EUROPÉENS. RÉGLAGE MACHINE EU CE89392 CEE II A.

RUNDE HEBESCHLINGEN, MIT INDIVIDUELLER BEDECKUNG, DIE VOR DEM ABSCHABEN SCHÜTZT, WLL IST AUF DER BEDECKUNG SELBST GEDRUCKT. DER DIN EN 1492-2 KONFORM ERSCHAFFEN. SICHERHEITSAKTOR 7. FARBKODE GEMÄSS DEN EUROPÄISCHEN STANDARDS. EU REGULIERUNG DER MASCHINE EU89392 EWG II A.

CÓDIGO CODE CODE	CMA. TN.	COLOR COLOR COULEUR	LONGITUD DE CIRCUNFERENCIA / CIRCUMFERENCE LENGTH / LONGUEUR DE CIRCUMFERENCE							
			2MT.	3MT.	4MT.	5MT.	6MT.	8MT.	10MT.	12MT.
SLT01	1		6,66	9,60	12,46	16,43	19,77	*	*	*
SLT02	2		10,36	15,09	19,69	24,20	28,24	38,80	53,00	65,02
SLT03	3		*	19,38	27,65	37,10	49,47	57,34	71,58	79,13
SLT04	4		*	*	31,53	38,98	45,59	66,21	88,67	97,18
SLT05	5		*	*	*	*	*	*	*	*
SLT06	6		*	*	*	*	*	*	*	*
SLT08	8		*	*	*	*	*	*	*	*
SLT10	10		*	*	*	*	*	*	*	*
			1 MT.	1,5MT.	2MT.	2,5MT.	3MT.	4MT.	5MT.	6MT.
			LONGITUD DE TRABAJO / WORK LENGTH / LONGUEUR DE TRAVAIL							

PRECIOS DE TARIFA / PRICE LIST / PRIX DES TARIFS / PREIS AUS TARIF - €/UNIDAD



























TABLA DE CAPACIDAD NOMINAL
ESLINGAS PLANAS Y ESLINGAS
TUBULARES SIN FIN

RATED CAPACITY TABLE
EYESLINGS AND ROUNDSLINGS

TABLEAU DES CAPACITÉS
NOMINALES

SANGLES À BOUCLES ET
SANGLES RONDES



CÓDIGO CODE CODE	CÓDIGO CODE CODE	COLOR COLOR COULEUR	FR.	1 ESLINGA 1 SLING 1 SANGLE					2 ESLINGAS 2 SLINGS 2 SANGLES		3 ESLINGAS 3 SLINGS 3 SANGLES	
				0°	0°	≤6°	7-45°	45-60°	0-45°	45-60°	0-45°	45-60°
SL01	SLT01											
SL02	SLT02											
SL03	SLT03			1,0	0,8	2,0	1,4	1,0	1,4	1,0	2,1	1,5
SL04	SLT04			2,0	1,6	4,0	2,8	2,0	2,8	2,0	4,2	3,0
SL05	SLT05			3,0	2,4	6,0	4,2	3,0	4,2	3,0	6,3	4,5
SL06	SLT06			4,0	3,2	8,0	5,6	4,0	5,6	4,0	8,4	6,0
SL08	SLT08			5,0	4,0	10,0	7,0	5,0	7,0	5,0	10,5	7,5
SL10	SLT10			6,0	4,8	12,0	8,4	6,0	8,4	6,0	12,6	9,0
				8,0	6,4	16,0	11,2	8,0	11,2	8,0	16,8	12,0
				10,0	8,0	20,0	14,0	10,0	14,0	10,0	21,0	15,0

* MEDIDAS SOLO DISPONIBLES POR ENCARGO / MEASURES ONLY AVAILABLE ON REQUEST / MESURES DISPONIBLES UNIQUEMENT SUR DEMANDE

LC.: CAPACIDAD DE AMARRE; STF.: FUERZA DE TENSIÓN ESTÁNDAR; CMA.: CARGA MÁXIMA ADMISIBLE / LC.: LASHING CAPACITY; STF.: STANDARD TENSION FORCE; CMA.: MAXIMUM ALLOWABLE LOAD.
LC.: CAPACITÉ D'ARRIMAGE; STF.: FORCE DE TENSION STANDARD; CMA.: CHARGE MAXIMALE ADMISIBLE.

PULPOS DE CADENA - GRADO 80

CHAIN SLINGS / ELINGUE DE CHAÎNE / ANSCHLAGKETTEN

GRADO 80

TIPOS DE PULPO / TYPES OF SLINGS / TYPES D'ÉLINGUES

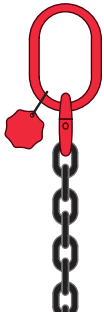

ESLINGA
SINGLE SLING
ÉLINGUE SIMPLE
1 STRÄNGIGE
ANSCHLAGKETTE

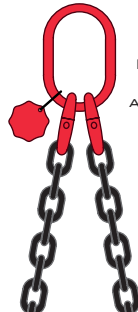

PULPO DE 2 RAMALES
DOUBLE SLINGS
ÉLINGUE DOUBLE
2 STRÄNGIGE
ANSCHLAGKETTEN

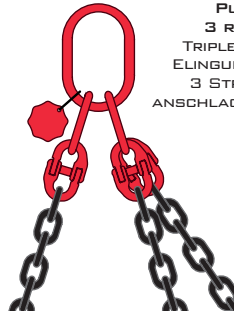

PULPO DE 3 RAMALES
TRIPLE SLINGS
ÉLINGUE TRIPLE
3 STRÄNGIGE
ANSCHLAGKETTEN



PULPO DE 4 RAMALES
QUADRUPLE SLINGS
ÉLINGUE QUADRUPLE
4 STRÄNGIGE
ANSCHLAGKETTEN

TERMINACIONES / TERMINATIONS / TERMINAISONS

CONEXIONES Y ACORTADORES / CONNECTIONS / CONNEXIONS

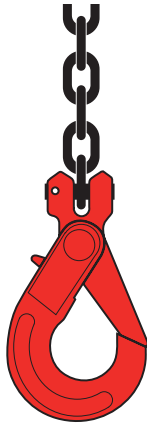

PARA PEDIR CUALQUIERA DE LOS CONJUNTOS SOLICITE UNA OFERTA A NUESTRO DEPARTAMENTO COMERCIAL
TO ORDER ANY OF THE SETS ASK FOR QUOTATION AT OUR SALES OFFICE
POUR COMMANDER QUELCONQUE DES ENSEMBLES DEMANDER LES PRIX À NOTRE BUREAU COMMERCIAL

CADENA ACERO NORMA EN 818-2 - GRADO 80

STEEL CHAIN ACCORDING TO EN 818-2 - 80 DEGREE
CHAÎNE ACIER SELON EN 818-2 - DEGRÉ 80
KETTE NACH EN 818-2 - GRAD 80

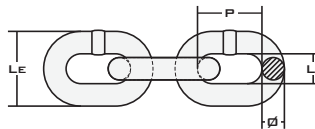

GRADO 80

CAJA

GRADO 80

CÓDIGO CODE CODE	MEDIDA SIZE MESURE	MEDIDA SIZE MESURE	CMA.	TOLERANCIA TOLERANCE TOLÉRANCES	P	TOLERANCIA TOLERANCE TOLÉRANCES	LI MIN.	LE MAX.	F MIN.	PESO WEIGHT POIDS	0 mt.	PRECIO TARIFA PRICE LIST PRIX TARIFS
	Ø m.m.	INCH.	TN.	m.m.	m.m.	m.m.	m.m.	m.m.	m.m.	Kg./mt.	0 mt.	€/1 mt.
CAD06	6	1/4	1,12	±0,24	18	±0,5	7,8	22,2	4,8	0,8	100	11,74
CAD08	8	5/16	2,00	±0,32	24	±0,7	10,4	29,6	6,4	1,4	100	16,77
CAD10	10	3/8	3,15	±0,40	30	±0,9	13,0	37,0	8	2,2	100	25,39
CAD13	13	1/2	5,30	±0,52	39	±1,2	16,9	48,1	10	3,8	100	41,91
CAD16	16	5/8	8,00	±0,64	48	±1,4	20,8	59,2	13	5,7	50	67,15
CAD20	20	3/4	12,50	±1,00	60	±1,8	26,0	74,0	16	9,0	30	105,19
CAD22*	22	7/8	15,00	±1,10	66	±2,0	28,6	81,4	18	10,9	25	CONSULTAR
CAD26*	26	1"	21,20	±1,30	78	±2,3	33,8	96,2	21	15,2	30	CONSULTAR
CAD32*	32	1 1/4"	31,50	±1,60	96	±2,9	41,6	118	26	23,0	25	CONSULTAR







* MEDIDAS SOLO DISPONIBLES POR ENGARGO / MEASURES ONLY AVAILABLE ON REQUEST / MESURES DISPONIBLES UNIQUEMENT SUR DEMANDE
CMA.: CARGA MÁXIMA ADMISIBLE. PA.: PAR DE APRIETE. / CMA.: MAXIMUM ALLOWABLE LOAD. PA.: TORQUE / CMA.: CHARGE MAXIMALE ADMISIBLE. PA.: COUPLE DE SERRAGE
COEFICIENTE DE SEGURIDAD - 4:1 / SAFETY RATIO - 4:1 / COEFFICIENT DE SÉCURITÉ - 4:1 / F = CURVA DE DEFLEXIÓN / F = FLÈCHE DE PLIAGE

CARGAS MÁXIMAS DE UTILIZACIÓN PARA LOS PULPOS - GRADO 80

WORKING LOAD LIMITS OF SLINGS - 80 DEGREE / CHARGE MAXIMALE D'UTILISATION POUR ELINGUE - DEGRÉ 80
 HÖCHSTE TRAGFÄHIGKEIT FÜR ANSCHLAGKETTEN - GRAD 80

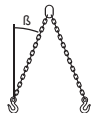
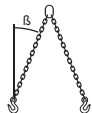
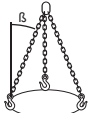
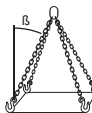
GRADO
80

CMU. DE ACUERDO CON NORMA EN 818-4 / WLL. ACCORDING TO EN 818-4 / WLL. SELON EN 818-4 / TRAGFÄHIGKEIT GEMASS DER NORM EN 818-4

CADENA CHAIN CHAÎNE KETTE	ESLINGA SINGLE LEG 1 BRIN 1 STRANG	2 RAMALES 2 LEGS 2 BRINS 2 STRÄNGE		3-4 RAMALES 3-4 LEGS 3-4 BRINS 3-4 STRÄNGE		ESLINGA CORREDERA CHOKER ENDLESS SLINGS ELINGUE SANS FIN A COULISSANT ENDLOSE SCHLINGKETTEN	ESLINGA CESTA LEGGED SLINGS CHAÎNE À BOUCHE SCHLAUFENGEHÄNGE	
								
FACTOR DE CARGA CHARGE FACTOR FACTEUR DE CHARGE TRAGLASTFAKTOR	1	1,4	1	2,1	1,5	1,6	1,4	2,1
		0° $\beta \leq 45^\circ$	45° $\beta \leq 60^\circ$	0° $\beta \leq 45^\circ$	45° $\beta \leq 60^\circ$		0° $\beta \leq 45^\circ$	0° $\beta \leq 45^\circ$
mm.	Kg.	Kg.	Kg.	Kg.	Kg.	Kg.	Kg.	Kg.
6	1.120	1.600	1.120	2.360	1.700	1.800	1.600	2.360
7	1.500	2.120	1.500	3.150	2.240	2.500	2.120	3.150
8	2.000	2.800	2.000	4.250	3.000	3.150	2.800	4.250
10	3.150	4.250	3.150	6.700	4.750	5.000	4.250	6.700
13	5.300	7.500	5.300	11.200	8.000	8.500	7.500	11.200
16	8.000	11.200	8.000	17.000	11.800	12.500	11.200	17.000
18	10.000	14.000	10.000	21.200	15.000	16.000	14.000	21.200
20	12.500	17.000	12.500	26.500	19.000	20.000	17.000	26.500
22	15.000	21.200	15.000	31.500	22.400	23.600	21.200	31.500
26	21.200	30.000	21.200	45.000	31.500	33.500	30.000	45.000
32	31.500	45.000	31.500	67.000	47.500	50.000	45.000	67.000

USO DE LA CADENA EN ÁNGULO / USE OF THE CHAIN ON EDGE / USAGE DE LA CHAÎNE SUR LE COIN / KANTENBELASTUNG

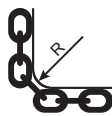

$R \geq$ AL DOBLE DEL DIÁMETRO DE LA CADENA
 $R \geq$ THAN DOUBLE CHAIN-DIAMETER
 $R \geq$ À DEUX FOIS LE DIAMÈTRE DE LA CHAÎNE
 $R \geq$ ALS 2x KETTEN-DURCHMESSER

1

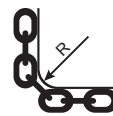

$R \geq$ AL DIÁMETRO DE LA CADENA
 $R \geq$ THAN THE CHAIN-DIAMETER
 $R \geq$ LE DIAMÈTRE DE LA CHAÎNE
 $R \geq$ ALS KETTEN-DURCHMESSER

0,7

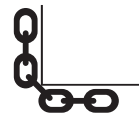

BORDE AFILADO
 SHARP EDGE
 COIN VIE
 SCHARFE KANTEN

0,5

FACTOR DE REDUCCIÓN

REDUCTION FACTOR
 FACTEUR DE RÉDUCTION
 REDUKTIONSFAKTOR

CARGA DE IMPULSO

IMPULSIVE LOAD
 CHARGÉ IMPULSIVE
 STOSSBELASTUNG (Ö-NORM M 9605)

IMPULSO LIGERO

LIGHT IMPULSE
 LÉGER PULSATION
 LEICHTE STÖSSE

1

IMPULSO MEDIO

MEDIUM IMPULSE
 MOYENNE PULSATION
 MITTLERE STÖSSE

0,7

IMPULSO FUERTE

STRONG IMPULSE
 FORT PULSATION
 STARKE STÖSSE

NO PERMITIDO

NOT ALLOWED
 PAS CONSENTIT
 UNZULÄSSIG

CARGAS MÁXIMAS DE UTILIZACIÓN PARA PULPOS - GRADO 80
 WORKING LOAD LIMITS OF SLINGS - 80 DEGREE
 CHARGE MAXIMALE D'UTILISATION POUR ELINGUE - DEGRÉ 80



INFORMACIÓN GENERAL PARA ACCESORIOS Y CADENAS DE GRADO 80
 GENERAL INFORMATION FOR ACCESSORIES AND CHAINS - 80 DEGREE
 INFORMATIONS GÉNÉRALES SUR LES ACCESSOIRES ET LES CHAÎNES DEGRÉ 80



* MEDIDAS SOLO DISPONIBLES POR ENCARGO / MEASURES ONLY AVAILABLE ON REQUEST / MESURES DISPONIBLES UNIQUEMENT SUR DEMANDE

CMA.: CARGA MÁXIMA ADMISIBLE, PA.: PAR DE APRIETE. / CMA.: MAXIMUM ALLOWABLE LOAD, PA.: TORQUE / CMA.: CHARGE MAXIMALE ADMISIBLE, PA.: COUPLE DE SERRAGE
 COEFICIENTE DE SEGURIDAD - 4:1 / SAFETY RATIO - 4:1 / COEFFICIENT DE SÉCURITÉ - 4:1 / F = CURVA DE DEFLEXIÓN / F = FLÈCHE DE PLIAGE

TARJETA DE IDENTIFICACIÓN - GRADO 80

IDENTIFICATION TAG / PLAQUE D'IDENTIFICATION / KENNENZEICHNUNG STAHLN-HÄNGER

 TARJETA DE IDENTIFICACIÓN
 TAG / PLAQUE
 (TT1 - TT2)

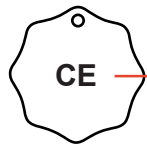
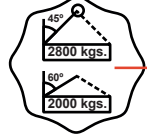
 ANILLA PARA TARJETA
 ONLY RING / ANNEAU
 (TT1)

 MARCADO CE
 CE MARKED
 MARQUAGE CE

 CARGA DE TRABAJO EN FUNCIÓN DE LOS ÁNGULOS
 WORKLOAD ACCORDING TO THE ANGLES
 CHARGE DE TRAVAIL EN FONCTION DES ANGLES

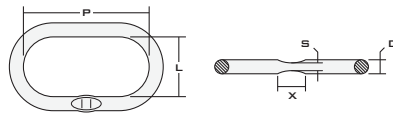
CÓDIGO CODE CODE		PRECIO TARIFA PRICE LIST PRIX TARIFS
		€/UNIDAD
TT1	50	3,89
TT2	50	3,89
TT1	50	1,81

ANILLA MAESTRA OVAL - GRADO 80

 OBLONG MASTERLINK - 80 DEGREE
 MAILLE DE TÊTE OVALE - DEGRÉ 80
 OVAL AUFHÄNGERINGE - GRAD 80

CAJA 
GRADO 80

CÓDIGO CODE CODE	∅ CADENA ∅ CHAIN ∅ CHAÎNE		D m.m.	P m.m.	L m.m.	SxX m.m.	CMA. TN.	PESO WEIGHT POIDS Kg.		PRECIO TARIFA PRICE LIST PRIX TARIFS €/UNIDAD
	⊥	∧								
AM00706	7	6	13	110	60	8x25	1,60	0,34	1	8,84
AM00807	8	7	16	110	60	8x25	2,12	0,53	1	12,50
AM01008	10	8	18	135	75	8x35	3,15	0,92	1	15,70
AM01310	13	10	22	160	90	11,5x35	5,30	1,60	1	24,66
AM01613	16	13	26	180	100	14x46	8,00	2,46	1	38,54
AM01816	18	16	32	200	110	18x46	11,20	4,14	1	63,83
AM02018*	20	18	36	260	140	-	14,00	6,22	1	CONSULTAR
AM02220*	22	20	40	300	160	-	17,00	8,95	1	CONSULTAR
AM02622*	26	22	45	340	180	-	21,20	12,82	1	CONSULTAR
AM03226*	32	26	51	350	190	-	31,50	16,55	1	CONSULTAR
AM03632*v	36	32	57	400	200	-	45,00	27,01	1	CONSULTAR

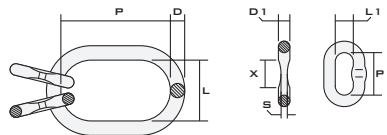
ANILLA MAESTRA OVAL ENSAMBLADA - GRADO 80

 SUB-ASSEMBLY OBLONG MASTERLINK - 80 DEGREE
 MAILLE DE TÊTE TRIPLE - DEGRÉ 80
 AUFHÄNGEKÖPFE - GRAD 80

CAJA 
GRADO 80

CÓDIGO CODE CODE	∅ CADENA ∅ CHAIN ∅ CHAÎNE	D m.m.	P m.m.	L m.m.	D1 m.m.	P1 m.m.	L1 m.m.	SxX m.m.	CMA. TN.	PESO WEIGHT POIDS Kg.		PRECIO TARIFA PRICE LIST PRIX TARIFS €/UNIDAD
AM0E06	6	18	135	75	13	54	25	8x25	2,36	1,31	1	35,69
AM0E08	8	22	160	90	16	70	34	8x25	4,25	2,32	1	54,47
AM0E10	10	26	180	100	18	85	40	11,5x35	6,70	3,52	1	74,24
AM0E13	13	32	200	110	22	115	50	14x35	11,20	6,26	1	127,15
AM0E16	16	36	260	140	26	140	65	18x46	17,00	9,56	1	205,15
AM0E18*	18	45	340	180	32	150	70	-	21,20	18,92	1	391,83
AM0E20*	20	51	350	190	32	150	70	-	26,50	22,65	1	536,41
AM0E22*	22	51	350	190	36	170	75	-	31,50	25,19	1	CONSULTAR
AM0E26*	26	57	400	200	40	170	80	-	45,00	36,01	1	CONSULTAR

GANCHO AUTOCIERRE - GRADO 80

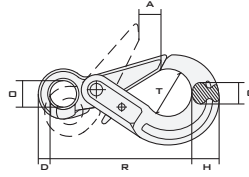
SELF LOOKING EYE HOOK - 80 DEGREE
CROCHET SECURITÉ AVEC LINGUET AUTOMATIQUE - DEGRÉ 80
SICHERHEITSHAKEN MIT AUTOMATISCHER SICHERUNG - GRAD 80



GRADO 80

CAJA

CÓDIGO CODE CODE	∅ CADENA	∅ CADENA	CMA.	A	D	G	H	O	R	T	PESO WEIGHT POIDS	PRECIO TARIFA PRICE LIST PRIX TARIFS	
	∅ CHAIN ∅ CHAÎNE	∅ CHAIN ∅ CHAÎNE											KG.
	m.m.	INCH.	TN.	m.m.	m.m.	m.m.	m.m.	m.m.	m.m.	m.m.	Kg.	€/UNIDAD	
GAD6	6	1/4	1,12	28	11	16	21	21	109	35	0,51	24	25,13
GAD8	7-8	5/16	2,00	34	12	20	26	25	135	43	0,94	18	26,58
GA10	10	3/8	3,15	45	16	25	30	33	168	56	1,63	8	50,39
GA13	13	1/2	5,30	51	20	35	40	40	205	69	3,25	6	103,24

GANCHO AUTOCIERRE GIRATORIO - GRADO 80

SWIVEL SELF LOOKING HOOK - 80 DEGREE / CROCHET
SECURITÉ À EMERILLON AVEC LINGUET AUTOMATIQUE -
DEGRÉ 80 / DREHBARER SICHERHEITSHAKEN MIT
AUTOMATISCHER SICHERUNG - GRAD 80

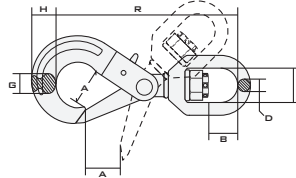

GRADO 80

CAJA

CÓDIGO CODE CODE	∅ CADENA	∅ CADENA	CMA.	R	A	B	D	D	G	H	PESO WEIGHT POIDS	PRECIO TARIFA PRICE LIST PRIX TARIFS	
	∅ CHAIN ∅ CHAÎNE	∅ CHAIN ∅ CHAÎNE											KG.
	m.m.	INCH.	TN.	m.m.	m.m.	m.m.	m.m.	m.m.	m.m.	m.m.	Kg.	€/UNIDAD	
GAG06	6	1/4	1,12	150	28	23	33	11	15	20	0,60	24	32,96
GAG08	7-8	5/16	2,00	185	34	27	37	13	19	24	1,10	18	44,86
GAG10	10	3/8	3,15	217	45	35	42	16	23	30	2,00	8	80,43
GAG13	13	1/2	5,30	271	54	43	48	21	27	40	4,00	6	163,39
GAG16	16	5/8	8,00	334	62	58	62	22	37	49	6,80	1	288,05

GANCHO AUTOCIERRE HORQUILLA - GRADO 80

SELF LOOKING CLEVIS HOOK - 80 DEGREE / CROCHET
SECURITÉ À CHAPE AVEC LINGUET AUTOMATIQUE -
DEGRÉ 80 / SICHERHEITSHAKEN MIT GABEL UND
AUTOMATISCHER SICHERUNG - GRAD 80

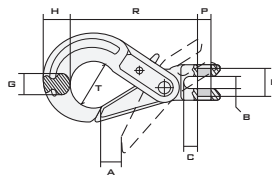

GRADO 80

CAJA

CÓDIGO CODE CODE	∅ CADENA	∅ CADENA	CMA.	A	B	C	G	H	R	T	PxL	PESO WEIGHT POIDS	PRECIO TARIFA PRICE LIST PRIX TARIFS	
	∅ CHAIN ∅ CHAÎNE	∅ CHAIN ∅ CHAÎNE												KG.
	m.m.	INCH.	TN.	m.m.	m.m.	m.m.	m.m.	m.m.	m.m.	m.m.	m.m.	Kg.	€/UNIDAD	
GAH06	6	1/4	1,12	28	7	8	16	21	94	35	7,5x17	0,49	24	24,72
GAH08	7-8	5/16	2,00	34	9	10	20	26	123	43	9x22,5	0,93	18	30,34
GAH10	10	3/8	3,15	45	12	14	25	30	143	56	13x31,5	1,58	8	53,67
GAH13	13	1/2	5,30	51	15	17	35	40	180	69	16x42	3,20	6	114,24
GAH16	16	5/8	8,00	60	19	19	36	50	215	80	21x51,5	5,95	1	180,62
GAH20	20	3/4	12,00	70	23	26	60	67	253	90	24x73	9,80	1	316,93

* MEDIDAS SOLO DISPONIBLES POR ENCARGO / MEASURES ONLY AVAILABLE ON REQUEST / MESURES DISPONIBLES UNIQUEMENT SUR DEMANDE
CMA.: CARGA MÁXIMA ADMISIBLE. PA.: PAR DE APRIETE. / CMA.: MAXIMUM ALLOWABLE LOAD. PA.: TORQUE / CMA.: CHARGE MAXIMALE ADMISIBLE. PA.: COUPLE DE SERRAGE
COEFICIENTE DE SEGURIDAD - 4:1 / SAFETY RATIO - 4:1 / COEFFICIENT DE SÉCURITÉ - 4:1 / F = CURVA DE DEFLEXIÓN / F = FLÈCHE DE PLIAGE

MAJLA DE CONEXIÓN - GRADO 80

CONNECTING LINK - 80 DEGREE
 MAILLON DE JONCTION - DEGRÉ 80
 VERBINDUNGSGLIED - GRAD 80

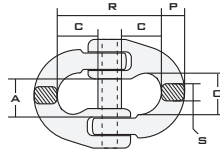

GRADO 80

CAJA

CÓDIGO CODE CODE	∅ CADENA	∅ CADENA	CMA.	A	C	O	R	P	S	PESO WEIGHT POIDS	PRECIO TARIFA PRICE LIST PRIX TARIFS	
	∅ CHAIN	∅ CHAIN										
	m.m.	INCH.	TN.	m.m.	m.m.	m.m.	m.m.	m.m.	m.m.	Kg.	€/UNIDAD	
MAC06	6	1/4	1,12	16	18	16,5	43	7,2	6,8	0,07	20	7,29
MAC07	7	9/32	1,50	17,8	20	20,5	50,5	8,5	9	0,10	30	9,00
MAC08	8	5/16	2,00	19	25,5	23,5	62	9,4	10	0,25	20	11,96
MAC10	10	3/8	3,15	23,8	30	27,5	72	12	12,6	0,35	40	13,67
MAC13	13	1/2	5,30	28	36	33,3	87,3	15,5	16,7	0,68	20	21,34
MAC16	16	5/8	8,00	34,3	40,5	39,5	103	21	20,6	1,10	12	35,72
MAC20*	20	3/4	12,50	44	48	47	116	23	23	1,70	8	66,75
MAC22*	22	7/8	15,00	49	51	55	133	26,5	26,5	2,20	5	CONSULTAR
MAC26*	26	1"	21,20	60	60	66	148	31,5	31,5	4,20	4	CONSULTAR
MAC32*	32	1"1/4	31,50	80	77	86	190	37	32	7,19	2	CONSULTAR

ACORTADOR CADENA - GRADO 80

SHORTENING CLUTCH - 80 DEGREE
 GRIFFE DE RACCOURCISSEMENT - DEGRÉ 80
 VERKÜRZUNGSKLAUE - GRAD 80

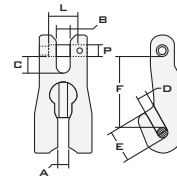

GRADO 80

CAJA

CÓDIGO CODE CODE	∅ CADENA	∅ CADENA	A	B	C	D	E	F	PxL	CMA.	PESO WEIGHT POIDS	PRECIO TARIFA PRICE LIST PRIX TARIFS	
	∅ CHAIN	∅ CHAIN											
	m.m.	INCH.	m.m.	m.m.	m.m.	m.m.	m.m.	m.m.	m.m.	TN.	Kg.	€/UNIDAD	
ACH08	8	5/16	9,5	9,5	10	9,5	23,5	56	10x22,5	2,00	0,48	36	37,61
ACH10	10	3/8	12	12	14,5	12	32,5	78	13x31,5	3,15	1,12	10	57,83
ACH13	13	1/2	15,5	15,5	18	15,5	44	90	16x42	5,30	1,83	8	76,98
ACH16	16	5/8	19	21	21	19	50	106	21x51,5	8,00	2,83	6	106,36

GANCHO PARA ACORTAR - GRADO 80

CLEVIS GRAP HOOK - 80 DEGREE / CROCHET DE RECCOURCISSEMENT À CHAPE - DEGRÉ 80
 VERKÜRZUNGSHAKEN MIT GABEL - GRAD 80

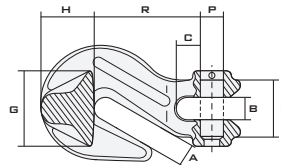

GRADO 80

CAJA

CÓDIGO CODE CODE	∅ CADENA	∅ CADENA	A	B	C	G	H	R	PxL	CMA.	PESO WEIGHT POIDS	PRECIO TARIFA PRICE LIST PRIX TARIFS	
	∅ CHAIN	∅ CHAIN											
	m.m.	INCH.	m.m.	m.m.	m.m.	m.m.	m.m.	m.m.	m.m.	TN.	Kg.	€/UNIDAD	
GACH08	8	5/16	10	9	10	30	24	50	9x22,5	2,00	0,27	40	6,36
GACH10	10	3/8	13	13	14	44	31	72	13x31,5	3,15	0,75	16	15,65
GACH13	13	1/2	17	17	17	53	38	88	16x42	5,30	1,35	10	30,16
GACH16	16	5/8	20	21	20	64	60	111	21x51,5	8,00	2,30	8	48,62
GACH20	20	3/4	24	24	24	85	65	130	24x61,5	12,50	4,10	4	122,88

* MEDIDAS SOLO DISPONIBLES POR ENCARGO / MEASURES ONLY AVAILABLE ON REQUEST / MESURES DISPONIBLES UNIQUEMENT SUR DEMANDE
 CMA.: CARGA MÁXIMA ADMISIBLE. PA.: PAR DE APRIETE. / CMA.: MAXIMUM ALLOWABLE LOAD. PA.: TORQUE / CMA.: CHARGE MAXIMALE ADMISIBLE. PA.: COUPLE DE SERRAGE
 COEFFICIENTE DE SEGURIDAD - 4:1 / SAFETY RATIO - 4:1 / COEFFICIENT DE SÉCURITÉ - 4:1 / F = CURVA DE DEFLEXIÓN / F = FLÈCHE DE PLIAGE

ANILLA ELEVACIÓN MACHO DIN 580 8.8

EYE BOLT DIN 580 8.8
 ANNEAU DE LEVAGE MALE DIN 580 8.8
 RINGSCHRAUBEN DIN 580 8.8

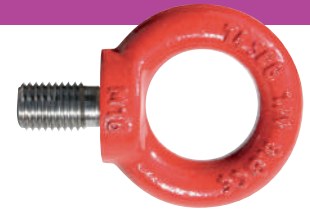
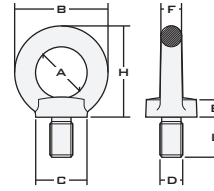
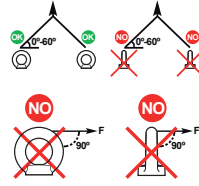

CAJA

CÓDIGO CODE CODE	MÉTRICA METRICS MÉTRIQUE	CMA. Q ^o	A	B	C	E	F	H	PESO WEIGHT POIDS	PRECIO TARIFA PRICE LIST PRIX TARIFS	
											(DxL) m.m.
5808008	M 8x13	0,8	25	45	25	10	10	45	0,090	50	18,06
5808010	M 10x17	1,0	25	45	25	10	10	45	0,110	50	21,24
5808012	M 12x21	1,6	35	63	35	14	14	62	0,270	20	24,31
5808016	M 16x27	4,0	35	63	35	14	14	62	0,310	20	25,39
5808020	M 20x30	6,0	50	90	50	20	20	90	0,860	8	54,57
5808024	M 24x36	8,0	50	90	50	20	20	90	0,900	8	60,41
5808030	M 30x45	12,0	60	108	65	24	24	109	1,700	4	102,77

ROSCAR A MAND / TO BE SCREWED BY HAND / A VISSER A MAIN / VON HAND AUFSCHAUBEN

ANILLA ELEVACIÓN HEMBRA DIN 582 8.8

EYE NUT DIN 582 8.8
 ANNEAU DE LEVAGE FEMELLE DIN 582 8.8
 RINGMUTTER DIN 582 8.8

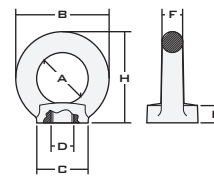
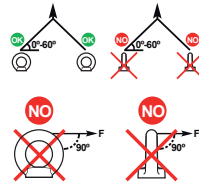

CAJA

CÓDIGO CODE CODE	MÉTRICA METRICS MÉTRIQUE	CMA. Q ^o	A	B	C	E	F	H	PESO WEIGHT POIDS	PRECIO TARIFA PRICE LIST PRIX TARIFS	
											(D) m.m.
5828008	M 8	0,8	25	45	25	10	10	45	0,100	50	15,49
5828010	M 10	1,0	25	45	25	10	10	45	0,100	50	18,15
5828012	M 12	1,6	35	63	35	14	14	62	0,260	20	19,93
5828016	M 16	4,0	35	63	35	14	14	62	0,260	20	22,03
5828020	M 20	6,0	50	90	50	20	20	90	0,750	8	48,11
5828024	M 24	8,0	50	90	50	20	20	90	0,750	8	54,77
5828030	M 30	12,0	60	108	65	24	24	109	1,400	4	92,77

ROSCAR A MAND / TO BE SCREWED BY HAND / A VISSER A MAIN / VON HAND AUFSCHAUBEN

ANILLA ELEVACIÓN GIRATORIA CON ANILLA - GRADO 80

ROTATING EYE BOLT WITH RING - 80 DEGREE
ANNEAU DE LEVAGE EMERILLON À OEIL - DEGRÉ 80
WIRBELBOCK - GRAD 80



INFORMACIÓN TÉCNICA
TECHNICAL SHEET



DE ACUERDO CON LAS DIRECTRICES TÉCNICAS GS-MO 1504 - EN 1677. DE ACUERDO CON LA DIRECTIVA DE MÁQUINAS 2006/42/CE. ANILLO GIRATORIO DE 360° CON INCLINACIÓN DE 180° PIVOTANTE.

IN COMPLIANCE WITH THE TECHNICAL DIRECTIVES GS-MO 1504 - EN 1677. IN COMPLIANCE WITH THE MACHINERY DIRECTIVE 2006/42/EC. CAN BE ORIENTED AT 360° WITH SELF ALIGNING TILTING RING AT 180°.

SELON LES NORMES TECHNIQUES GS-MO 1504 - EN 1677. CONFORMÉMENT À LA DIRECTIVE MACHINES 2006/42/CE. ORIENTABLE À 360° AVEC ANNEAU BASCULANT À 180° À AUTO-ALIGNEMENT.

NACH GS-MO 1504 - EN 1677. HEBEN VON LASTEN GEMÄSS MASCHINENRICHTLINIE 2006/42/EG. 360° DREHBAR - ÖSE 180° SELBSTAUSRICHTEND SCHWENKBAR.

CAJA

CÓDIGO CODE CODE	MÉTRICA METRICS MÉTRIQUE (DxL) m.m.	CMA. ° TN.	A m.m.	B m.m.	C m.m.	E m.m.	H m.m.	SW m.m.	D1 m.m.	PESO WEIGHT POIDS Kg.		PRECIO TARIFA PRICE LIST PRIX TARIFS €/UNIDAD
CEA801218	M12x18	0,50	30	13	46	50	105	30	38	0,500	12	103,34
CEA801620	M16x20	1,12	30	13	46	50	105	30	38	0,530	12	107,40
CEA802030	M20x30	2,00	30	13	46	50	105	30	38	0,530	12	132,00
CEA802430	M24x30	3,15	40	19	70	68	153	48	58	1,630	12	166,76
CEA803035	M30x35	5,30	40	20	65	80	165	65	75	2,230	4	219,56

ROSCAR A MANO. COEFICIENTE DE SEGURIDAD 4 EN TODAS LA DIRECCIONES DE CARGA.
TO BE SCREWED BY HAND. COEFFICIENT 4 IN ALL LOADING DIRECTIONS.
A VISSER A MAIN. COEFFICIENT DE SÉCURITÉ DE 4 DANS TOUTES LES DIRECTIONS DE CHARGE.
VON HAND AUFSCHRAUBEN. 4-FACHE SICHERHEIT IN ALLEN BELASTUNGSRICHTUNGEN.

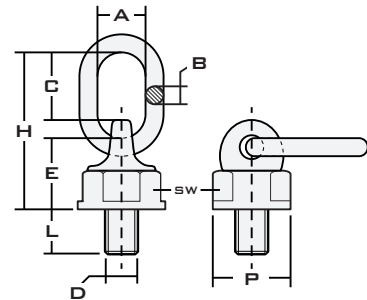

DISPONEMOS, BAJO PEDIDO, DE UNA GRAN GAMA DE PRODUCTOS CON RESISTENCIA GRADO 100
AVAILABLE ON REQUEST A WIDE RANGE OF PRODUCTS WITH RESISTANCE GRADE 100
NOUS AVONS, SUR DEMANDE, UNE LARGE GAMME DE PRODUITS AVEC RÉSIDENCE DEGRÉ 100



GRADO
100

SENSOR HORQUILLA - HORQUILLA INOXIDABLE A-4

STAINLESS STEEL AISI 316 TURNBUCKLES WITH 2 FORKS
RIDOIRS À DEUX CHAPES EN ACIER INOX. A-4
WANTENSPANNER MIT ZWEI GABELN AUS ROSTFREIEM STAHL



INOX A4

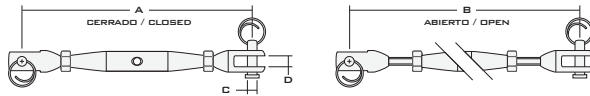

CAJA

CÓDIGO CODE CODE	MÉTRICA METRICS MÉTRIQUE	Ø CABLE Ø ROPE Ø CABLE	A	B	C	D	PESO WEIGHT POIDS	CAJA	INOX. A-4	
									PRECIO TARIFA PRICE LIST PRIX TARIFS	
									€/UNIDAD	
THHA404	M 4	2	110	160	4	4	0,04	6	9,59	
THHA405	M 5	2,5	120	180	4	5	0,06	6	10,95	
THHA406	M 6	3	135	190	5	6	0,08	6	12,00	
THHA408	M 8	4	160	220	7	8	0,16	6	20,49	
THHA410	M10	5	185	260	8	10	0,27	6	33,97	
THHA412	M12	6-7	250	365	10	12	0,38	6	51,62	
THHA414	M14	8	260	380	12	14	0,68	2	69,80	
THHA416	M16	10	305	460	14	16	1,03	2	99,98	

SENSOR HORQUILLAS SOLDADAS INOXIDABLE A-4

STAINLESS STEEL AISI 316 TURNBUCKLES WITH 2 WELDED FORKS
RIDOIRS À DEUX CHAPES SOUDÉES EN ACIER INOX. A-4
WANTENSPANNER MIT ZWEI GESCHWEISSTEN GABELN AUS ROSTFREIEM STAHL

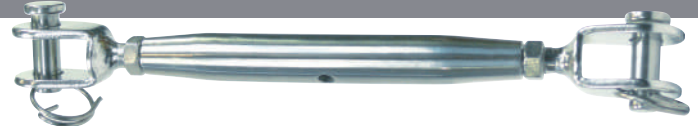

INOX A4

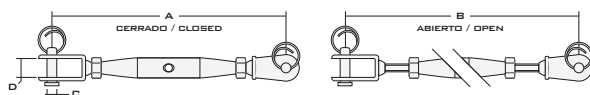

CAJA

CÓDIGO CODE CODE	MÉTRICA METRICS MÉTRIQUE	Ø CABLE Ø ROPE Ø CABLE	A	B	C	D	PESO WEIGHT POIDS	CAJA	INOX. A-4	
									PRECIO TARIFA PRICE LIST PRIX TARIFS	
									€/UNIDAD	
THHSA406	M 6	3	135	200	6	11	0,08	10	10,90	
THHSA408	M 8	4	145	210	6	11	0,16	10	16,13	
THHSA410	M10	5	180	250	8	13	0,27	6	25,24	
THHSA412	M12	6-7	210	300	12	12	0,38	6	43,08	

SENSOR HORQUILLAS MÓVILES INOXIDABLE A-4

STAINLESS STEEL AISI 316 TURNBUCKLES WITH 2 JOINT FORKS
RIDOIRS À DEUX CHAPES ARTICULÉES EN ACIER INOX. A-4
WANTENSPANNER MIT ZWEI GELENKGABELN AUS ROSTFREIEM STAHL



INOX A4

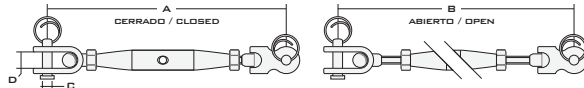

CAJA

CÓDIGO CODE CODE	MÉTRICA METRICS MÉTRIQUE	Ø CABLE Ø ROPE Ø CABLE	A	B	C	D	PESO WEIGHT POIDS	CAJA	INOX. A-4	
									PRECIO TARIFA PRICE LIST PRIX TARIFS	
									€/UNIDAD	
THHGA406	M 6	3	135	190	5	8	0,09	6	15,70	
THHGA408	M 8	4	190	260	8	10	0,18	6	22,16	
THHGA410	M10	5	230	320	8	12	0,34	4	36,54	
THHGA412	M12	6-7	280	380	8	14	0,54	4	68,12	

ENSOR HORQUILLA - TERMINAL PRENSABLE INOX. A-4

STAINLESS STEEL AISI 316 TURNBUCKLES WITH FORK & TERMINAL
RIDOIRS À UNE CHAPE ET UN EMBOUT A SERTIR EN ACIER INOX. A-4
WANTENSPANNER MIT GABEL UND TERMINAL ZUM WALZEN



INOX A4

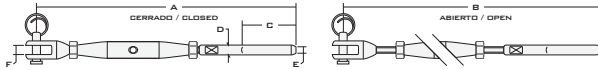

CAJA

CÓDIGO CODE CODE	MÉTRICA METRICS MÉTRIQUE	Ø CABLE Ø ROPE Ø CABLE	A	B	C	D	E	F	PESO WEIGHT POIDS		INOX. A-4
											PRECIO TARIFA PRICE LIST PRIX TARIFS
											€/UNIDAD
THTA406	M 6	3	185	230	32	6	3,2	6	0,08	6	11,11
THTA408	M 8	4	210	275	40	8	4,2	8	0,13	6	17,24
THTA410	M10	5	235	325	50	10	5,2	10	0,23	6	34,38
THTA412	M12	6	320	435	60	12	6,2	12	0,48	6	48,49
THTA414	M14	7	360	515	70	14	7,2	14	0,62	2	66,16
THTA416	M16	8	415	575	78	16	8,2	16	1,12	2	108,52

ENSOR HORQUILLA MÓVIL - TERMINAL PRENSABLE INOX. A-4

STAINLESS STEEL AISI 316 TURNBUCKLES WITH JOINT FORK & TERMINAL
RIDOIRS À CHAPE ARTICULÉE ET EMBOUT A SERTIR ACIER INOX. A-4
WANTENSPANNER MIT GELENKGABEL UND TERMINAL ZUM WALZEN

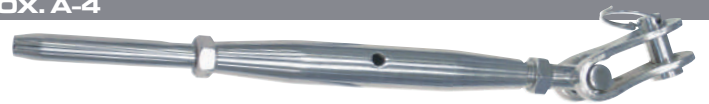

INOX A4

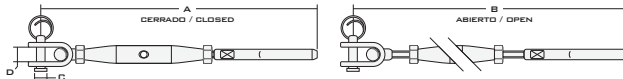

CAJA

CÓDIGO CODE CODE	MÉTRICA METRICS MÉTRIQUE	Ø CABLE Ø ROPE Ø CABLE	A	B	C	D	E	F	PESO WEIGHT POIDS		INOX. A-4
											PRECIO TARIFA PRICE LIST PRIX TARIFS
											€/UNIDAD
THGTA406	M 6	3	150	200	6	8	8	0,08	6	14,38	
THGTA408	M 8	4	190	250	8	10	10	0,15	6	15,51	
THGTA410	M10	5	235	305	10	12	12	0,28	6	30,63	
THGTA412	M12	6-7	310	410	12	14	14	0,50	4	51,66	

INSTALACIONES

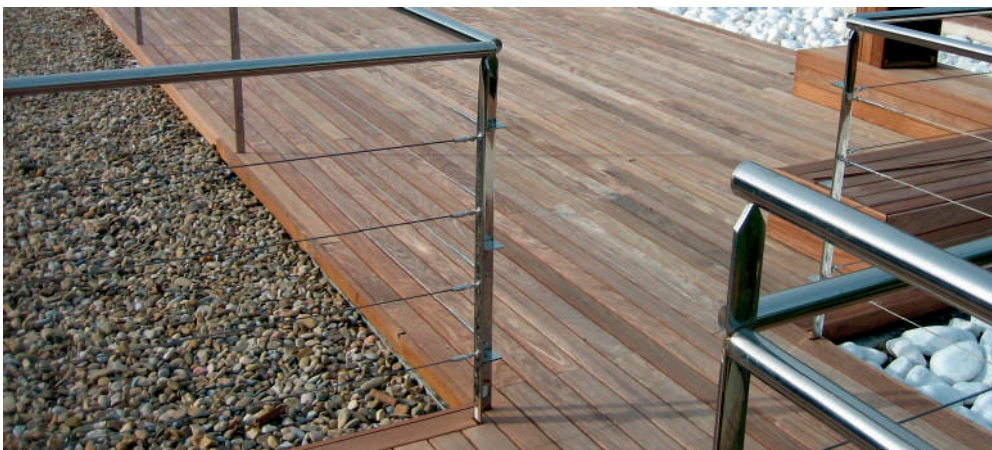

SENSOR ARO - ARO INOXIDABLE A-4

STAINLESS STEEL AISI 316 TURNBUCKLES WITH 2 EYES
RIDOIRS À DEUX ANNEAUX EN ACIER INOX. A-4
WANTENSPIANNER MIT ZWEI ÖSEN AUS ROSTFREIEM STAHL

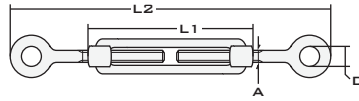

CAJA

CÓDIGO CODE CODE	MÉTRICA METRICS MÉTRIQUE	CMA.	D	L1	L2	PESO WEIGHT POIDS		INOX. A-4	
								PRECIO TARIFA PRICE LIST PRIX TARIFS	€/UNIDAD
	(A) m.m.	Kg.	m.m.	m.m.	m.m.	Kg.			
TAAA406	M 6	225	10	90	140÷220	0,08	10		5,67
TAAA408	M 8	410	14	120	180÷280	0,16	10		10,21
TAAA410	M10	650	16	150	230÷360	0,25	10		16,70
TAAA412	M12	930	18	200	280÷460	0,56	6		29,24
TAAA416	M16	1.770	26	250	370÷590	1,00	6		66,26

SENSOR ARO - GANCHO INOXIDABLE A-4

STAINLESS STEEL AISI 316 TURNBUCKLES EYE & HOOK
RIDOIRS ANNEAU ET CROCHET EN ACIER INOX. A-4
SPANNSCHLÖSSER MIT ÖSE UND HAKEN AUS ROSTFREIEM STAHL

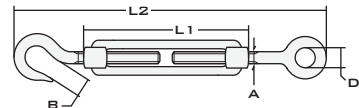

CAJA

CÓDIGO CODE CODE	MÉTRICA METRICS MÉTRIQUE	CMA.	B	D	L1	L2	PESO WEIGHT POIDS		INOX. A-4	
									PRECIO TARIFA PRICE LIST PRIX TARIFS	€/UNIDAD
	(A) m.m.	Kg.	m.m.	m.m.	m.m.	m.m.	Kg.			
TAGA405	M 5	50	9	8	70	110÷170	0,04	10	4,03	
TAGA406	M 6	75	10	10	90	140÷220	0,08	10	5,67	
TAGA408	M 8	165	11	14	120	180÷280	0,17	10	10,21	
TAGA410	M10	235	12	16	150	230÷360	0,27	10	16,70	
TAGA412	M12	320	14	18	200	280÷460	0,56	6	29,24	
TAGA416	M16	530	16	26	250	370÷590	1,10	6	66,26	
TAGA420	M20	730	18	30	300	420÷650	1,90	6	149,95	

SENSOR GANCHO - GANCHO INOXIDABLE A-4

STAINLESS STEEL AISI 316 TURNBUCKLES WITH TWO HOOKS
RIDOIRS À DEUX CROCHETS EN ACIER INOX. A-4
SPANNSCHLÖSSER MIT ZWEI HAKEN AUS ROSTFREIEM STAHL

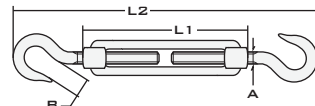

CAJA

CÓDIGO CODE CODE	MÉTRICA METRICS MÉTRIQUE	CMA.	B	L1	L2	PESO WEIGHT POIDS		INOX. A-4	
								PRECIO TARIFA PRICE LIST PRIX TARIFS	€/UNIDAD
	(A) m.m.	Kg.	m.m.	m.m.	m.m.	Kg.			
TGGA406	M 6	75	10	90	140÷220	0,08	10		5,67
TGGA408	M 8	165	11	120	180÷280	0,16	10		10,21
TGGA410	M10	235	12	150	230÷360	0,25	10		16,70
TGGA412	M12	320	14	200	280÷460	0,56	6		29,24
TGGA416	M16	530	16	250	370÷590	1,10	6		66,26

TERMINAL PRENSABLE HORQUILLA INOXIDABLE A-4 ¹

STAINLESS STEEL AISI 316 FORK TERMINALS
EMBOUTS À CHAPE A SERTIR EN ACIER INOX. A-4
GESCHWEISSTE GABELTERMINALS ZUM WALZEN AUS ROSTFREIEM STAHL

**INOX
A4**

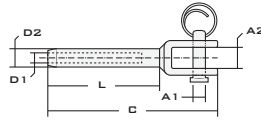

CAJA

INOX. A-4

CÓDIGO CODE CODE	Ø CABLE Ø ROPE Ø CABLE	D1	D2	L	A1	A2	C	PESO WEIGHT POIDS		PRECIO TARIFA PRICE LIST PRIX TARIFS
	m.m.	m.m.	m.m.	m.m.	m.m.	m.m.	m.m.	Kg.		€/UNIDAD
THPA404	4	4,2	7,5	43	6	8	82	0,05	10	5,27
THPA405	5	5,2	9,1	52	8	10	100	0,06	10	6,67
THPA406	6	6,6	12,5	63	9	12	120	0,13	10	12,46
THPA408	8	8,2	16,1	78	12	15,5	165	0,23	10	25,12
THPA410	10	10,5	17,8	90	16	14	170	0,33	10	34,42
THPA412	12	12,5	21,4	105	16	16	210	0,52	5	42,46

TERMINAL PRENSABLE OJO INOXIDABLE A-4 ¹

STAINLESS STEEL AISI 316 EYE TERMINAL
EMBOUTS À OBL A SERTIR EN ACIER INOX. A-4
AUGENTERMINALS ZUM WALZEN AUS ROSTFREIEM STAHL

**INOX
A4**

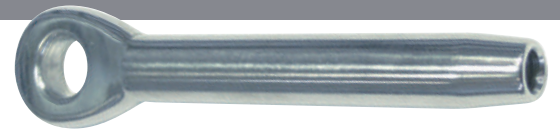
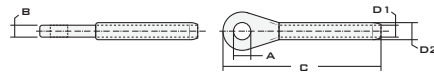

CAJA

INOX. A-4

CÓDIGO CODE CODE	Ø CABLE Ø ROPE Ø CABLE	A	B	C	D1	D2	PESO WEIGHT POIDS		PRECIO TARIFA PRICE LIST PRIX TARIFS
	m.m.	m.m.	m.m.	m.m.	m.m.	m.m.	Kg.		€/UNIDAD
TOA404	4	8	5	70	4,2	7,5	0,03	10	4,19
TOA405	5	10	6	90	5,2	9,1	0,05	10	5,05
TOA406	6	12	8	120	6,6	12,5	0,09	10	9,29
TOA408	8	14	10	140	8,2	16,1	0,16	10	16,84
TOA410	10	16	12	165	10,5	17,8	0,32	10	24,93
TOA412	12	18	14	190	12,5	20,0	0,46	5	41,42

TERMINAL PRENSABLE INOXIDABLE A-4 ¹

STAINLESS STEEL AISI 316 SWAGE STUDS
EMBOUTS À SERTIR EN ACIER INOX. A-4
TERMINAL ZUM WALZEN AUS ROSTFREIEM STAHL

**INOX
A4**

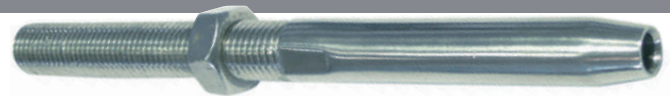
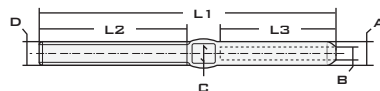

CAJA

INOX. A-4

CÓDIGO CODE CODE	MÉTRICA METRICS MÉTRIQUE	Ø CABLE Ø ROPE Ø CABLE	L1	L2	L3	A	B	C	PESO WEIGHT POIDS		PRECIO TARIFA PRICE LIST PRIX TARIFS
	(D) m.m.	m.m.	m.m.	m.m.	m.m.	m.m.	m.m.	m.m.	Kg.		€/UNIDAD
TPA406	6	3	100	39	48	6,3	3,3	5	0,030	1	2,77
TPA408	8	4	117	45	57	7,5	4,3	5,9	0,070	1	3,42
TPA410	10	5	130	51	63	9	5,3	6,9	0,080	1	5,26
TPA412	12	6	162	64	80	12,5	6,3	10,8	0,110	1	11,34

DMA.: CARGA MÁXIMA ADMISIBLE, PA.: PAR DE APRIETE. / DMA.: MAXIMUM ALLOWABLE LOAD, PA.: TORQUE / DMA.: CHARGE MAXIMALE ADMISIBLE, PA.: COUPLE DE SERRAGE
¹ REQUIERE DE UNA PRESSE PARA FIJAR EL CABLE AL TERMINAL. / IT REQUIRES A PRESS TO FIX THE CABLE TO THE TERMINAL. / REQUIERT UNE PRESSE POUR FIXER LE CÂBLE AU TERMINAL.

SUJETACABLES DIN 741 INOXIDABLE A-4

STAINLESS STEEL AISI 316 WIRE ROPE CLIPS
SERRE-CABLES À ÉTRIER EN ACIER INOX. A-4
DRAHTSEILKLEMMEN AUS ROSTFREIEM STAHL

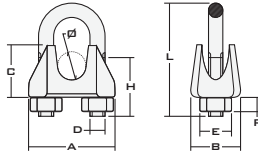

INOX A4

CAJA

CÓDIGO CODE CODE	MEDIDA SIZE MESURE (∅) m.m.	A m.m.	B m.m.	C m.m.	E m.m.	F m.m.	H m.m.	L m.m.	D m.m.	PESO WEIGHT POIDS Kg.	PRECIO TARIFA PRICE LIST PRIX TARIFS €/UNIDAD
741A404	3-4	22	14	8	7	3,5	12	22	4	0,01	2,06
741A405	5	24	16	9	8	4	15	24	5	0,02	2,36
741A406	6	30	18	11	10	5	18	33	6	0,03	2,50
741A408	8	33	20	12	10	5	20	35	6	0,04	2,59
741A410	10	37	22	14	13	6,5	22	43	8	0,07	5,42
741A412	12	45	25	16	17	8	30	54	10	0,12	8,87
741A414	14	46	27	18	17	8	30	54	10	0,15	9,62
741A416	16	53	30	20	17	8	30	65	10	0,20	11,80
741A420	19-20	58	33	22	19	10	35	80	12	0,27	17,34

AUTOSERVICIO

CÓDIGO CODE CODE	MEDIDA SIZE MESURE (∅) m.m.	PRECIO TARIFA PRICE LIST PRIX TARIFS €/BOLSA	
		10	12
BF741A404	3-4	28,54	
BF741A405	5	22,41	
BF741A406	6	19,54	
BF741A408	8	18,04	

**PEDIDO MÍNIMO 1 EMBALAJE
MINIMUM ORDER 1 PACKAGING**

GUARDACABOS INOXIDABLE A-4

STAINLESS STEEL AISI 316 THIMBLES
COSSES COEUR EN ACIER INOX. A-4
KAUSCHEN AUS ROSTFREIEM STAHL

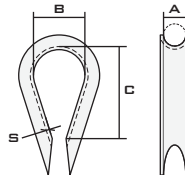

INOX A4

CAJA

CÓDIGO CODE CODE	MEDIDA SIZE MESURE (A) m.m.	B m.m.	C m.m.	S m.m.	PESO WEIGHT POIDS Kg.	PRECIO TARIFA PRICE LIST PRIX TARIFS €/UNIDAD
GCA404	4	11	18	1,0	0,008	0,49
GCA405	5	14	20	1,2	0,010	0,69
GCA406	6	15	23	1,2	0,010	0,85
GCA408	8	18	29	1,5	0,020	1,52
GCA410	10	24	37	1,5	0,030	2,36
GCA412	12	29	50	1,5	0,040	3,21
GCA414	14	33	54	2,0	0,080	4,90
GCA416	16	37	64	2,0	0,120	6,65

AUTOSERVICIO

CÓDIGO CODE CODE	MEDIDA SIZE MESURE (A) m.m.	PRECIO TARIFA PRICE LIST PRIX TARIFS €/BOLSA	
		10	12
BFGCA404	4	7,69	
BFGCA405	5	7,63	
BFGCA406	6	8,29	
BFGCA408	8	8,30	

**PEDIDO MÍNIMO 1 EMBALAJE
MINIMUM ORDER 1 PACKAGING**

PRENSACABLES SIMPLE INOXIDABLE A-4

STAINLESS STEEL AISI 316 SIMPLEX WIRE ROPE CLIPS
SERRE-CABLES SIMPLEX EN ACIER INOX. A-4
SIMPLEX DRAHTSEILKLEMMEN AUS ROSTFREIEM STAHL

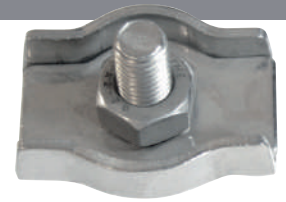
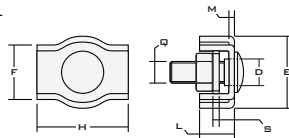

INOX A4

CAJA

CÓDIGO CODE CODE	Ø CABLE Ø ROPE Ø CABLE	D	E	F	H	L	M	Q	S	PESO WEIGHT POIDS	PRECIO TARIFA PRICE LIST PRIX TARIFS	INOX. A-4	
												Kg.	€/UNIDAD
PCA403	3	5	15	10	17,5	6,5	1,5	M 4	1,5	0,02	100	1,06	
PCA404	4	6,5	18	12	22	7,5	1,5	M 5	1,5	0,03	100	1,49	
PCA405	5	6,5	20	14	24	8,5	1,5	M 5	1,5	0,03	100	1,93	
PCA406	6	7	23	17	30	10	1,5	M 6	1,5	0,04	100	2,85	
PCA408	8	10	30	22	36	14	2	M 8	2	0,05	100	4,95	
PCA410	10	11	34	25	42	16	2	M10	3	0,09	50	10,21	

AUTOSERVICIO

CÓDIGO CODE CODE	Ø CABLE Ø ROPE Ø CABLE	PRECIO TARIFA PRICE LIST PRIX TARIFS	INOX. A-4	
			€/BOLSA	
BFPCA403	3	12	12	21,50
BFPCA404	4	10	12	21,85
BFPCA405	5	8	12	18,38
BFPCA406	6	6	12	25,57

PEDIDO MÍNIMO 1 EMBALAJE
MINIMUM ORDER 1 PACKAGING

PRENSACABLES DOBLE INOXIDABLE A-4

STAINLESS STEEL AISI 316 DUPLEX WIRE ROPE CLIPS
SERRE-CABLES DUPLEX EN ACIER INOX. A-4
DUPLEX DRAHTSEILKLEMMEN AUS ROSTFREIEM STAHL

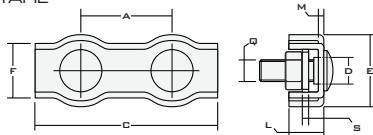

INOX A4

CAJA

CÓDIGO CODE CODE	Ø CABLE Ø ROPE Ø CABLE	A	C	D	E	F	L	M	Q	S	PESO WEIGHT POIDS	PRECIO TARIFA PRICE LIST PRIX TARIFS	INOX. A-4	
													Kg.	€/UNIDAD
PCDA403	3	20,5	38	5	15	10	6,5	1,5	M 4	1,5	0,030	100	1,75	
PCDA404	4	25	47	6,5	18	12	7,5	1,5	M 5	1,5	0,030	100	2,57	
PCDA405	5	27	51	6,5	20	14	8,5	1,5	M 5	1,5	0,028	100	3,20	
PCDA406	6	33	63	7	23	17	10	1,5	M 6	1,5	0,050	100	5,01	
PCDA408	8	42	76	10	30	22	14	2	M 8	2	0,100	50	9,26	
PCDA410	10	46	88	11	34	25	16	2	M10	3	0,180	50	15,28	

NUEVO PRODUCTO / NEW PRODUCT / NOUVEAU PRODUIT

GANCHO "S" INOXIDABLE A-4

STAINLESS STEEL AISI 316 "S" HOOK
CROCHETS "S" EN ACIER INOX. A-4
"S" HAKEN AUS ROSTFREIEM STAHL

CAJA

CÓDIGO CODE CODE	MEDIDA SIZE MESURE	L	E	PRECIO TARIFA PRICE LIST PRIX TARIFS	
					€/UNIDAD
ESEA403	(Ø) 3	30	4	10	0,46
ESEA404	4	40	6,5	10	0,69
ESEA405	5	50	8	5	1,03
ESEA406	6	60	9	5	1,55
ESEA408	8	80	12	5	2,87

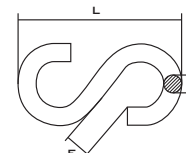

PRENSA HIDRÁULICA DE 12 Tn

12 Tn HYDRAULIC CRIMPING PLIER
PRESSE HYDRAULIQUE - 12 Tn
HYDRAULISCHE PRESSZANGE - 12 Tn



Cod.: MPH
MORDAZA
CRIMPING DIE
BÂILLON
PRESSEINSÄTZE



Cod.: PH
PRENSA HIDRÁULICA
HYDRAULIC CRIMPING PLIER
PRESSE HYDRAULIQUE
HYDRAULISCHE PRESSZANGE

CON UNA FUERZA DE 12 TONELADAS Y UNA ANCHO DE 12 MM, LAS PRENSAS HIDRÁULICAS SON IDEALES PARA PRENSAR EL CABLE DE FORMA RÁPIDA Y ECONÓMICA DIRECTAMENTE EN EL LUGAR. SE SUMINISTRA EN UNA CAJA DE PLÁSTICO Y SIN MORDAZAS.

WITH A FORCE OF 12 TONS AND A WIDTH OF 12MM, THE HYDRAULIC PLIERS ARE IDEALLY SUITED FOR QUICKLY AND INEXPENSIVELY CRIMPING THE WIRE ROPE DIRECTLY ON SITE. SUPPLIED IN A PLASTIC CASE WITHOUT CRIMPING DIES.

AVEC UNE FORCE DE 12 TONNES ET UNE LARGUER DE 12 MM, LES PRESSES HYDRAULIQUES SONT IDÉALES POUR PRESSER LE CÂBLE D'UNE MANIÈRE RAPIDE ET ÉCONOMIQUE DIRECTEMENT SUR LE LIEU. LA PRESSE HYDRAULIQUE EST FOURNIE DANS UNE BOÎTE EN PLASTIQUE ET SANS BÂILLONS.



MORDAZAS / CRIMPING DIES / BÂILLONS / PRESSEINSÄTZE

CÓDIGO CODE CODE	∅ CABLE ∅ ROPE ∅ CABLE	∅ EXT. TERMINAL ∅ TERMINAL OUTSIDE ∅ EXT. TERMINAL		PRECIO TARIFA PRICE LIST PRIX TARIFS
	m.m.	m.m.		€/UNIDAD
MPH3	3	6,4	1	288,00
MPH4	4	7,5	1	288,00
MPH5	5	9,0	1	288,00
MPH6	6	12,5	1	288,00

PRENSA HIDRÁULICA / HYDRAULIC CRIMPING PLIER / PRESSE HYDRAULIQUE / HYDRAULISCHE PRESSZANGE

CÓDIGO CODE CODE	CARACTERÍSTICAS FEATURES CARACTÉRISTIQUES		PRECIO TARIFA PRICE LIST PRIX TARIFS
			€/UNIDAD
PH	12 TN - 12MM	1	370,00

ALICATES PICO DE LORO

WIRE ROPE CUTTER
CISAILLE POUR CÂBLE
DRAHTSEILSCHERE



Cod.: CCPL05 - ∅ MAX. 5MM



Cod.: CCPL12 - ∅ MAX. 12MM

CÓDIGO CODE CODE	∅ MAX. CABLE WIRE ROPE MAX. ∅ ∅ MAX. CÂBLE	LONGITUD LENGTH LONGUEUR		PRECIO TARIFA PRICE LIST PRIX TARIFS
	m.m.	m.m.		€/UNIDAD
CCPL05	5	195	1	34,00
CCPL12	12	470	1	440,00

GRILLETE RECTO INOXIDABLE A-4

STAINLESS STEEL AISI 316 "D" SHACKLES
MANILLES DROITES EN ACIER INOX. A-4
GERADE SCHÄKEL AUS ROSTFREIEM STAHL

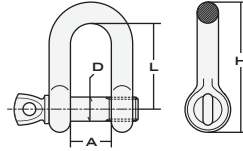

INOX
A4

CAJA

CÓDIGO CODE CODE	MEDIDA SIZE MESURE (D) m.m.	CMA. Kg.	A m.m.	L m.m.	H m.m.	PESO WEIGHT POIDS Kg.	CAJA	INOX. A-4
								PRECIO TARIFA PRICE LIST PRIX TARIFS €/UNIDAD
GRA405	5	70	10	20	30	0,02	30	2,00
GRA406	6	100	14	26	37	0,03	30	2,36
GRA408	8	250	16	32	48	0,07	25	3,90
GRA410	10	400	20	45	64	0,13	20	6,29
GRA412	12	630	25	48	72	0,22	25	10,29
GRA416	16	1.000	34	64	96	0,38	10	23,24

AUTOSERVICIO

CÓDIGO CODE CODE	MEDIDA SIZE MESURE (D) m.m.	CAJA	CANTIDAD	INOX. A-4
				PRECIO TARIFA PRICE LIST PRIX TARIFS €/BOLSA
BFGRA405	5	6	12	21,44
BFGRA406	6	4	12	15,69
BFGRA408	8	2	12	11,54

PEDIDO MÍNIMO 1 EMBALAJE
MINIMUM ORDER 1 PACKAGING

GRILLETE LIRA INOXIDABLE A-4

STAINLESS STEEL AISI 316 BOW SHACKLES
MANILLES LYRE EN ACIER INOX. A-4
GESCHWEIFTE SCHÄKEL AUS ROSTFREIEM STAHL

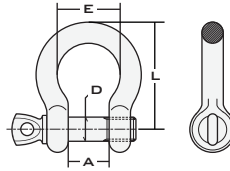

INOX
A4

CAJA

CÓDIGO CODE CODE	MEDIDA SIZE MESURE (D) m.m.	CMA. Kg.	A m.m.	E m.m.	L m.m.	PESO WEIGHT POIDS Kg.	CAJA	INOX. A-4
								PRECIO TARIFA PRICE LIST PRIX TARIFS €/UNIDAD
GLA405	5	80	10	15,0	20	0,020	60	2,21
GLA406	6	100	14	21,0	24	0,030	60	2,57
GLA408	8	200	16	24,0	32	0,080	25	4,16
GLA410	10	300	20	31,0	40	0,130	10	6,49
GLA412	12	500	26	38,0	48	0,224	5	11,39
GLA414	14	600	30	43,5	63,5	0,346	5	17,85
GLA416	16	800	32	52,0	64	0,370	5	22,34
GLA420	19	1.100	42	59,0	76	0,950	2	50,47
GLA425	25	2.000	54	76,5	100	2,200	2	97,42

AUTOSERVICIO

CÓDIGO CODE CODE	MEDIDA SIZE MESURE (D) m.m.	CAJA	CANTIDAD	INOX. A-4
				PRECIO TARIFA PRICE LIST PRIX TARIFS €/BOLSA
BFGLA405	5	6	12	22,32
BFGLA406	6	4	12	17,54
BFGLA408	8	2	12	12,70

PEDIDO MÍNIMO 1 EMBALAJE
MINIMUM ORDER 1 PACKAGING

GRILLETE TORCIDO INOXIDABLE A-4

STAINLESS STEEL AISI 316 TWISTED SHACKLES
MANILLES TORSÉES EN ACIER INOX. A-4
GEDREHTE SCHÄKEL AUS ROSTFREIEM STAHL

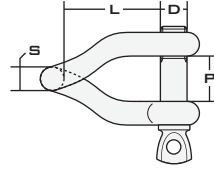

INOX
A4

CAJA

CÓDIGO CODE CODE	MEDIDA SIZE MEASURE (D) m.m.	P m.m.	L m.m.	S m.m.	PESO WEIGHT POIDS Kg.	PRECIO TARIFA PRICE LIST PRIX TARIFS €/UNIDAD
GRRA404	4	8	22	4	0,01	20 2,34
GRRA405	5	10	28	5	0,01	20 2,52
GRRA406	6	12	34	6	0,03	20 2,77
GRRA408	8	16	40	8	0,07	20 6,03
GRRA410	10	20	45	10	0,13	20 9,21
GRRA412	12	24	52	12	0,22	20 17,21

GRILLETE GIRATORIO HORQUILLAS INOXIDABLE A-4

STAINLESS STEEL AISI 316 JAW & JAW SWIVELS
EMERILLONS AVEC DEUX MANILLES EN ACIER INOX. A-4
WIRBEL GABEL-GABEL AUS ROSTFREIEM STAHL

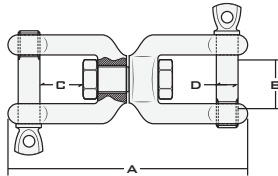

INOX
A4

CAJA

CÓDIGO CODE CODE	MEDIDA SIZE MEASURE (D) m.m.	CMA. Kg.	A m.m.	B m.m.	C m.m.	PESO WEIGHT POIDS Kg.	PRECIO TARIFA PRICE LIST PRIX TARIFS €/UNIDAD
GGHHA406	6	350	66	12	11	0,066	10 5,59
GGHHA408	8	650	94	16	16	0,170	10 10,83
GGHHA410	10	1.000	118	20	22	0,330	10 20,49
GGHHA413	13	1.400	152	26	28	0,667	10 40,47
GGHHA416	16	2.500	188	32	37	1,148	10 78,51
GGHHA419	19	4.000	229	38	45	2,084	5 143,72

GRILLETE GIRATORIO INOXIDABLE A-4

STAINLESS STEEL AISI 316 SWIVELS
EMERILLONS EN ACIER INOX. A-4
WIRBEL AUS ROSTFREIEM STAHL

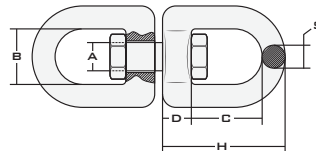

INOX
A4

CAJA

CÓDIGO CODE CODE	MEDIDA SIZE MEASURE m.m.	CMA. Kg.	A m.m.	B m.m.	C m.m.	D m.m.	H m.m.	S m.m.	PESO WEIGHT POIDS Kg.	PRECIO TARIFA PRICE LIST PRIX TARIFS €/UNIDAD
GGA413	13	875	14	32	46	18	77	13	0,53	5 35,77
GGA416	16	1.250	16	39	56	22	94	16	1,14	5 63,95
GGA420	20	2.500	20	41	63	33	115	19	1,83	3 118,42
GGA425	25	4.000	25	63	88	35	148	25	4,00	2 241,75

MOSQUETÓN GRILLETE GIRATORIO INOXIDABLE A-4

STAINLESS STEEL AISI 316 SWIVEL SNAP SHACKLES
MOUSQUETONS DE DRISSE À EMERILLON EN ACIER INOX. A-4
KARABINERHAKEN MIT WIRBEL AUS ROSTRFREIEM STAHL

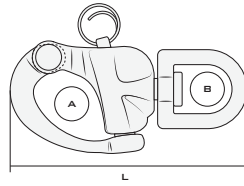

INOX A4

CAJA

CÓDIGO CODE CODE	MEDIDA SIZE MESURE m.m.	A m.m.	B m.m.	L m.m.	PESO WEIGHT POIDS Kg.	CAJA	INOX. A-4
							PRECIO TARIFA PRICE LIST PRIX TARIFS €/UNIDAD
MGGA401	1	12	12	70	0,05	10	9,52
MGGA402	2	16	16	87	0,12	10	13,59
MGGA403	3	22	22	128	0,33	10	28,95

MOSQUETÓN GANCHO INOXIDABLE A-4

STAINLESS STEEL AISI 316 SPRING SNAPS
MOUSQUETONS À RESORT EN ACIER INOX. A-4
KARABINERHAKEN AUS ROSTRFREIEM STAHL

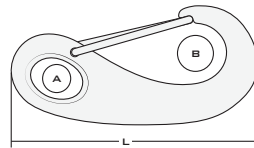

INOX A4

CAJA

CÓDIGO CODE CODE	MEDIDA SIZE MESURE (L) m.m.	A m.m.	B m.m.	PESO WEIGHT POIDS Kg.	CAJA	INOX. A-4
						PRECIO TARIFA PRICE LIST PRIX TARIFS €/UNIDAD
MGA4050	50	6	8	0,02	10	2,42
MGA4070	70	10	12	0,05	10	3,95
MGA4100	100	13	16	0,15	10	10,70

MALLA RÁPIDA INOXIDABLE A-4

STAINLESS STEEL AISI 316 QUICK LINKS
MAILLONS RAPIDES EN ACIER INOX. A-4
KETTENGLIED AUS ROSTRFREIEM STAHL

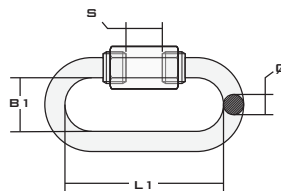

INOX A4

CAJA

CÓDIGO CODE CODE	MEDIDA SIZE MESURE (∅) m.m.	L1 m.m.	B1 m.m.	S m.m.	PESO WEIGHT POIDS Kg.	CAJA	INOX. A-4
							PRECIO TARIFA PRICE LIST PRIX TARIFS €/UNIDAD
MRA404	4	32	12	5,5	0,01	30	1,98
MRA405	5	39	13	6,5	0,02	30	2,55
MRA406	6	45	14	7,5	0,03	30	3,52
MRA408	8	58	18	9,5	0,08	25	6,65
MRA410	10	69	22	12,0	0,15	10	11,38
MRA412	12	81	24	14,5	0,23	10	17,93

AUTOSERVICIO

INOX. A-4

CÓDIGO CODE CODE	MEDIDA SIZE MESURE (∅) m.m.	CAJA	PRECIO TARIFA PRICE LIST PRIX TARIFS €/BOLSA	
				BFMRA404
BFMRA405	5	3	12	12,33
BFMRA406	6	2	12	12,24
BFMRA408	8	2	12	23,90

**PEDIDO MÍNIMO 1 EMBALAJE
MINIMUM ORDER 1 PACKAGING**

MOSQUETÓN BOMBERO INOXIDABLE A-4

STAINLESS STEEL AISI 316 SNAP HOOKS
MOUSQUETONS EN ACIER INOX. A-4
KARABINERHAKEN AUS ROSTFREIEM STAHL

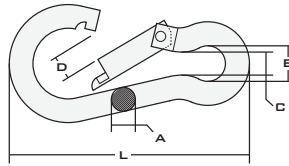

INOX A4

CAJA

CÓDIGO CODE CODE	MEDIDA SIZE MESURE (L) m.m.	A m.m.	B m.m.	C m.m.	D m.m.	PESO WEIGHT POIDS Kg.		INOX. A-4	
								PRECIO TARIFA PRICE LIST PRIX TARIFS €/UNIDAD	
MBA4040	40	4	6	5,0	6	0,008	60	1,86	
MBA4050	50	5	8	6,0	7	0,020	60	1,98	
MBA4060	60	6	9	7,5	8	0,030	60	2,53	
MBA4080	80	8	12	9,0	11	0,070	40	4,62	
MBA4100	100	10	15	10,5	13	0,130	20	8,57	
MBA4120	120	11	19	15,5	16	0,190	20	11,80	

AUTOSERVICIO

CÓDIGO CODE CODE	MEDIDA SIZE MESURE (L) m.m.			INOX. A-4	
				PRECIO TARIFA PRICE LIST PRIX TARIFS €/BOLSA	
BFMBA4040	40	8	12	22,94	
BFMBA4050	50	6	12	21,75	
BFMBA4060	60	4	12	19,00	
BFMBA4080	80	2	12	14,72	

PEDIDO MÍNIMO 1 EMBALAJE
MINIMUM ORDER 1 PACKAGING

MOSQUETÓN BOMBERO CON SEGURO INOXIDABLE A-4

SS. AISI 316 SNAP HOOKS WITH SAFETY SCREW
MOUSQUETONS À VIS DE SECURITÉ EN ACIER INOX. A-4
KARABINERHAKEN MIT SCHRAUBSICHERUNG

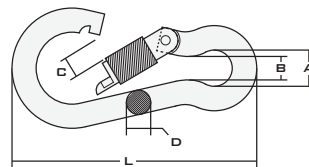

INOX A4

CAJA

CÓDIGO CODE CODE	MEDIDA SIZE MESURE (L) m.m.	CMA. Kg.	A m.m.	B m.m.	C m.m.	D m.m.	PESO WEIGHT POIDS Kg.		INOX. A-4	
									PRECIO TARIFA PRICE LIST PRIX TARIFS €/UNIDAD	
MBSA4100	100	350	15	10,5	13	10	0,133	10	32,92	
MBSA4120	120	450	18	12,0	16	11	0,189	10	40,46	

MOSQUETÓN ASIMÉTRICO INOXIDABLE A-4

STAINLESS STEEL AISI 316 ASYMETRICAL SNAP HOOKS
MOUSQUETONS ASYMETRIQUES EN ACIER INOX. A-4
ASYMMETRISCHE KARABINERHAKEN AUS EDELSTAHL

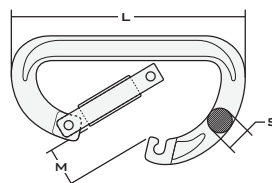

INOX A4

CAJA

CÓDIGO CODE CODE	MEDIDA SIZE MESURE (L) m.m.	S m.m.	M m.m.	PESO WEIGHT POIDS Kg.		INOX. A-4	
						PRECIO TARIFA PRICE LIST PRIX TARIFS €/UNIDAD	
MAA4080	80	8	12	0,07	10	17,84	
MAA4100	100	10	18	0,13	10	29,35	

ANILLA ELEVACIÓN MACHO DIN 580 INOXIDABLE A-4

STAINLESS STEEL AISI 316 EYE BOLTS DIN 580
ANNEAU DE LEVAGE DIN 580 EN ACIER INOX. A-4
RINGSCHRAUBEN DIN 580 AUS ROSTFREIEM STAHL

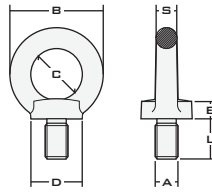

INOX A4

CAJA

INOX. A-4

CÓDIGO CODE CODE	MÉTRICA METRICS MÉTRIQUE	CMA. 0°	CMA. 45°	B	C	D	E	L	S	PA.	PESO WEIGHT POIDS	PRECIO TARIFA PRICE LIST PRIX TARIFS	
													(A) m.m.
580A406	M 6	90	60	36	20	20	6	13	8	3,5	0,05	10	3,59
580A408	M 8	140	100	36	20	20	6	13	8	8	0,06	10	3,59
580A410	M10	230	170	45	25	25	8	17	10	16	0,12	10	7,02
580A412	M12	340	240	54	30	30	10	20,5	12	28	0,18	10	12,26
580A414	M14	500	350	54	30	30	10	20,5	12	45	0,19	10	12,59
580A416	M16	700	500	63	35	35	12	27	14	70	0,31	10	22,36
580A420	M20	1.200	860	72	40	40	14	30	16	135	0,44	10	30,85

ANILLA ELEVACIÓN HEMBRA DIN 582 INOXIDABLE A-4

STAINLESS STEEL AISI 316 EYE NUTS DIN 582
ANNEAU DE LEVAGE DIN 582 EN ACIER INOX. A-4
RINGMUTTERN DIN 582 AUS ROSTFREIEM STAHL

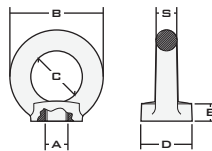

INOX A4

CAJA

INOX. A-4

CÓDIGO CODE CODE	MÉTRICA METRICS MÉTRIQUE	CMA. 0°	CMA. 45°	B	C	D	E	S	PA.	PESO WEIGHT POIDS	PRECIO TARIFA PRICE LIST PRIX TARIFS	
												(A) m.m.
582A406	M 6	90	60	36	20	20	8,5	8	3,5	0,06	10	3,59
582A408	M 8	140	100	36	20	20	8,5	8	8	0,05	10	3,59
582A410	M10	230	170	45	25	25	10	10	16	0,10	10	6,72
582A412	M12	340	240	54	30	30	11	12	28	0,16	10	11,42
582A414	M14	500	350	54	30	30	11	12	45	0,16	10	12,59
582A416	M16	700	500	63	35	35	13	14	70	0,24	10	17,06
582A420	M20	1.200	860	72	40	40	16	16	135	0,38	10	25,90

BULÓN OJO CON TUERCA Y ARANDELA INOXIDABLE A-4

STAINLESS STEEL AISI 316 EYE BOLTS WITH NUT & WASHER
PITONS À OEIL AVEC ÉCROU ET RONDELLE EN ACIER INOX. A-4
AUGENBOLZEN MIT FESTER ÖSE AUS ROSTFREIEM STAHL

INOX A4

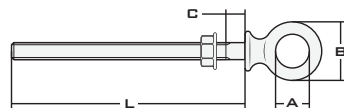

CAJA

INOX. A-4

CÓDIGO CODE CODE	MEDIDA SIZE MESURE	A	B	C	PESO WEIGHT POIDS	PRECIO TARIFA PRICE LIST PRIX TARIFS	
							(MxL) m.m.
B0A406060	6x60	12	22	6	0,03	20	3,42
B0A406080	6x80	12	22	8	0,03	20	3,93
B0A408060	8x60	14	27	6	0,05	20	5,09
B0A408080	8x80	14	27	8	0,06	20	5,44
B0A408100	8x100	14	27	10	0,06	20	5,97
B0A410100	10x100	16	31	10	0,10	20	8,18
B0A412120	12x120	18	36	12	0,16	20	13,82



NUEVA GAMA DE PRODUCTOS



EXPOSITOR AUTOSERVICIO DE PARED 234x100x50 cm

WALL STAND - 234x100x50 cm

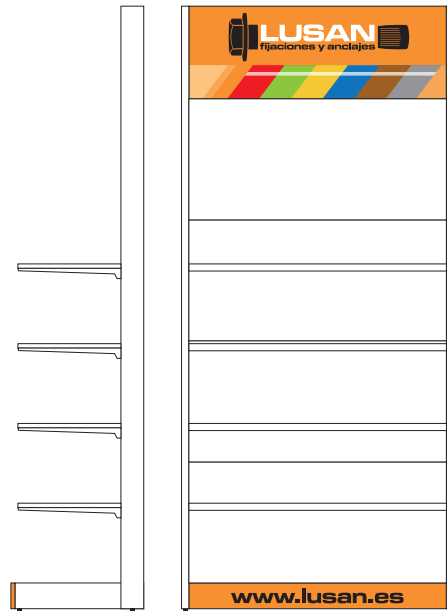
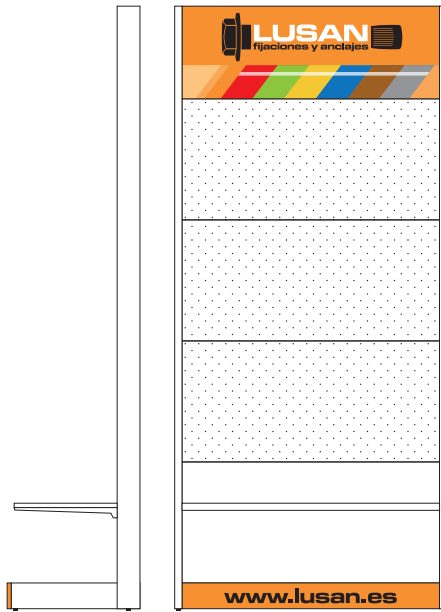

2 BALDAS / 2 SHELVES

CÓDIGO
CODE / CODE

EXPOSFF

PRECIO TARIFA
PRICE LIST / PRIX TARIFS
€/UNIDAD.

531,25

5 BALDAS / 5 SHELVES

CÓDIGO
CODE / CODE

EXPOSFL

PRECIO TARIFA
PRICE LIST / PRIX TARIFS
€/UNIDAD.

781,25

EXPOSITOR AUTOSERVICIO "GÓNDOLA" 140x100x108 cm

"GÓNDOLA" STAND - 100x140x108 cm

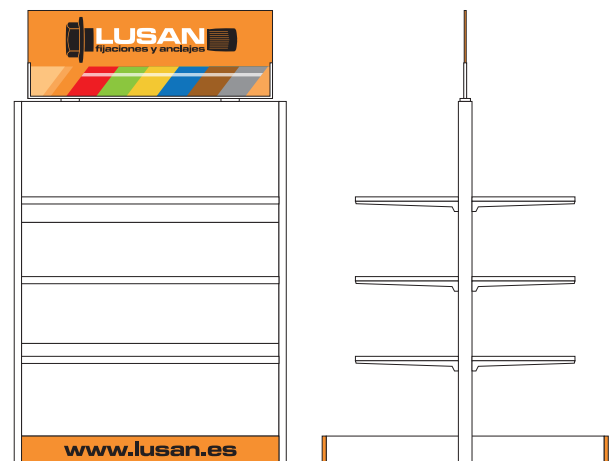
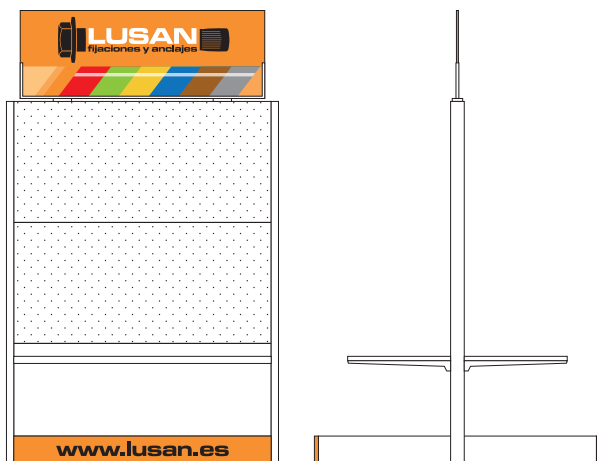

4 BALDAS / 4 SHELVES

CÓDIGO
CODE / CODE

EXPOGNDP

PRECIO TARIFA
PRICE LIST / PRIX TARIFS
€/UNIDAD.

1.043,25

8 BALDAS / 8 SHELVES

CÓDIGO
CODE / CODE

EXPOGND

PRECIO TARIFA
PRICE LIST / PRIX TARIFS
€/UNIDAD.

1.250,00

GANCHOS PARA PANEL PERFORADO

HOOKS FOR PERFORATED PANELS

GANCHOS CON CARTEL

CÓDIGO
CODE / CODE

PRECIO TARIFA
PRICE LIST / PRIX TARIFS
€/UNIDAD.

GANCHOE

4,19

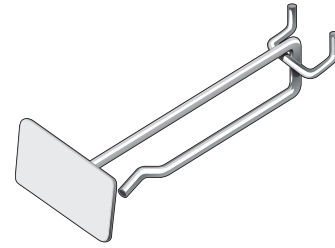

EXPOSITOR AUTOSERVICIO "GAMA NYLON" 160x60x32 cm

"GAMA NYLON" STAND - 160x60x32 cm

CÓDIGO
CODE / CODE

PRECIO TARIFA
PRICE LIST / PRIX TARIFS
€/UNIDAD.

ETN

125,00



EXPOSITOR AUTOSERVICIO "SOBREMESA" 99x44x31 cm

DISPLAY STAND - 99x44x31 cm

CÓDIGO
CODE / CODE

PRECIO TARIFA
PRICE LIST / PRIX TARIFS
€/UNIDAD.

EBB

188,00

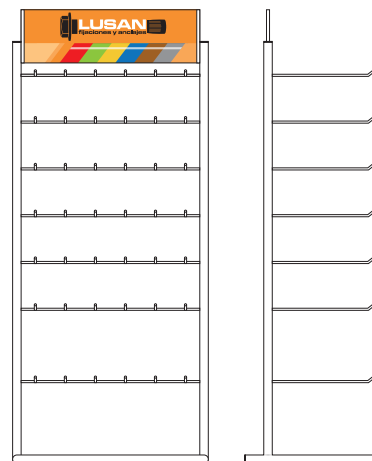

REPRESENTANTE

20

ANIVERSARIO



LUSAN FIJACIONES Y ANCLAJES S.L.

SEDE PRINCIPAL : C/Molinos, nº 20, CP. 29491 Algatocín (Málaga) SPAIN

DELEGACIÓN : Pol. Ind. Pla de la Bruguera, C/Solsonés nº 66

CP. 08211 Castellar del Vallès (Barcelona) SPAIN

E-mail: lusan@lusan.es Web: www.lusan.es



CERTIFIED M.S.
EN ISO 9001:2015
154ES26

